

合成器編曲

2019 Sep

MADZINE

從編曲出發的合成器音色課程

	大綱	課程內容
		<u>入門概述</u>
1	合成器歷史與美學架構	認識經典合成器與推薦聆聽
2	合成器基礎架構	合成器組成元件、發聲數與 Unison
3	各部位功能一覽、分析音色分類	合成器基礎參數、辨別不同音色特色、MIDI 控制器
4	Envelope 與音色分類的關聯	認識 Envelope 與 Gate 的關聯、以及與不同音色的連結
		<u>基礎合成器架構與編曲</u>
5	編曲練習 - 1	只使用 Synth String 音色透過調整 ADSR 變成不同樂器功能的編曲練習
6	設計泛音	Oscillator、Wavetable、Ring Modulation、Phase Modulation 與 Sync
7	編曲練習 - 2	為 Lead 與 Bass 音色設計泛音、利用 Pitch Env 製作大鼓或 Sync 音色
8	Filter	認識 Filter 模式、參數、與有名的 Filter 型號
		<u>進階動態設計</u>
9	編曲練習 - 3	利用 LP、HP、BP 取代 EQ 在多層 PAD 音色的泛音規劃
10	以 Envelope 為主軸的 Modulation	複習 Envelope，以及不同 Modulation 的可能性
11	編曲練習 - 4	利用各種速度的 Env 在 PAD、ARP、Bass、Kick 上設計彈性
12	更多 Modulation Source	LFO、Sequencer、與演奏用介面
		<u>演奏與深度探討進階合成法</u>
13	編曲練習 - 5	利用 Modulation Wheel 或 Velocity 控制 Mod Amount 來設計演奏音色
14	FM 合成法	學習以 DX7 為代表的 FM 合成法
15	VCV Rack	透過免費軟體 VCV Rack 學習模組成器架構
16	進階合成法	西岸 (Music Easel)、物理建模 (Elements)、粒子合成 (Clouds)

聲音是什麼？

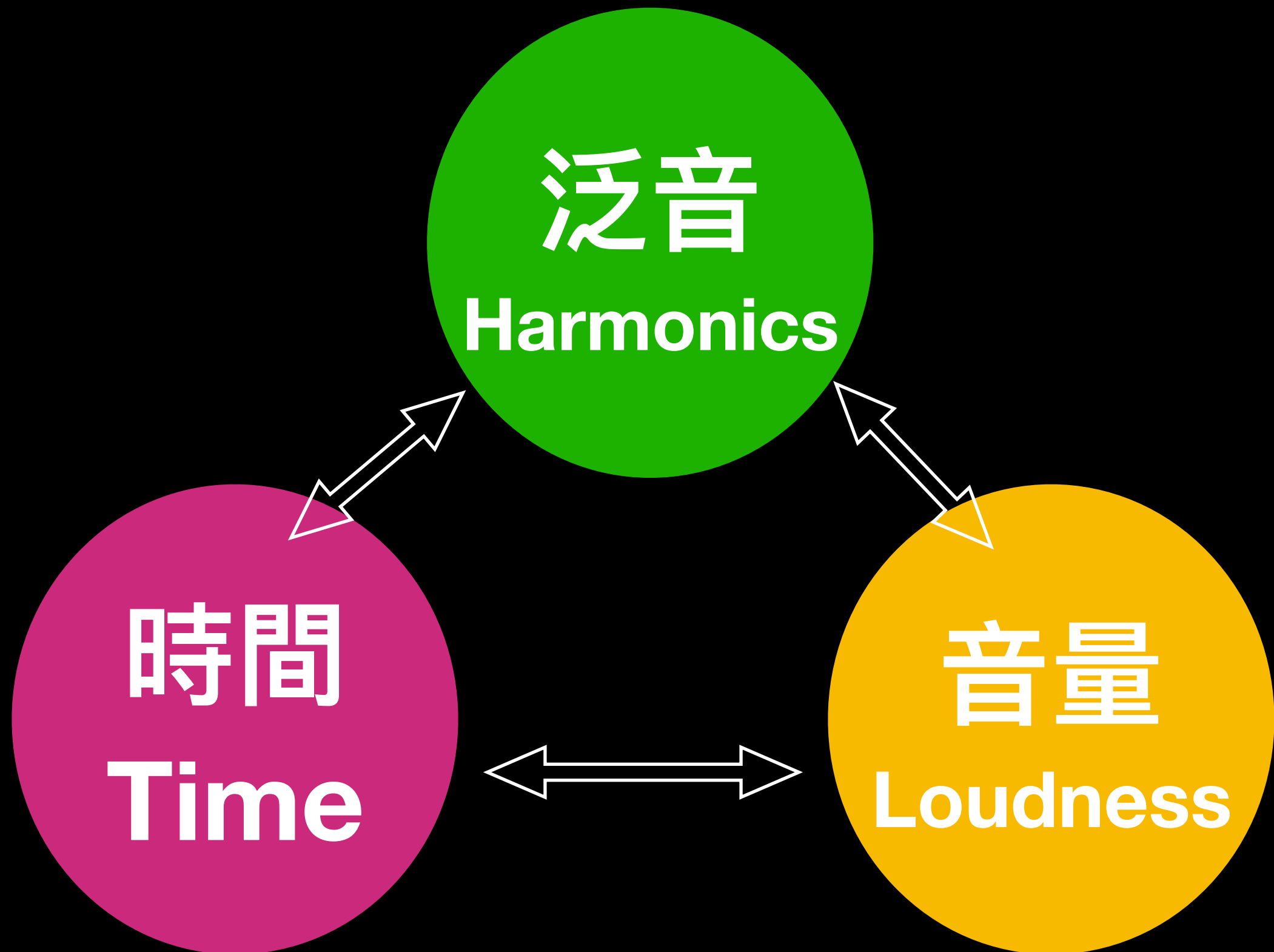

合成器歷史

電子樂器與經典音色

MADZINE

早期電子樂器

電子樂器與電子合成器

MADZINE

電子樂器

- 以物理震動產生電流訊號，經由擴大機發聲的樂器



- Theremin (1920~)
- 章世和 (獅子吼)



樂器

- 一個可以用固定的互動方式控制音高與音量的媒材



- Theremin (1920~)



電子樂器

- 以物理震動產生電流訊號，經由擴大機發聲的樂器
- Hammond Organ (1935~1967~)

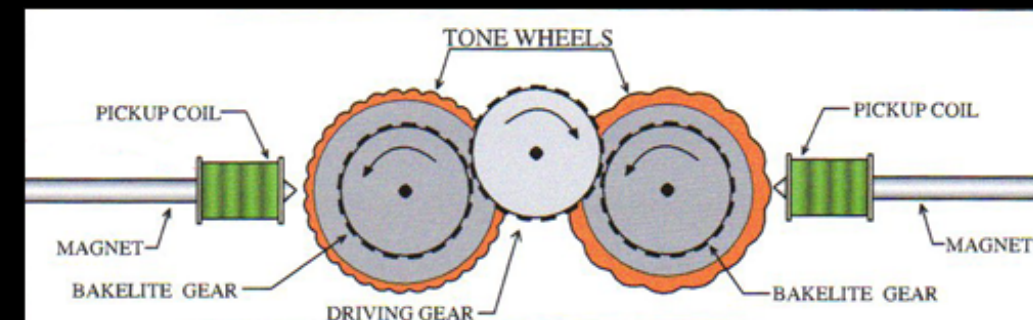

電子樂器

- 以物理震動產生電流訊號，經由擴大機發聲的樂器

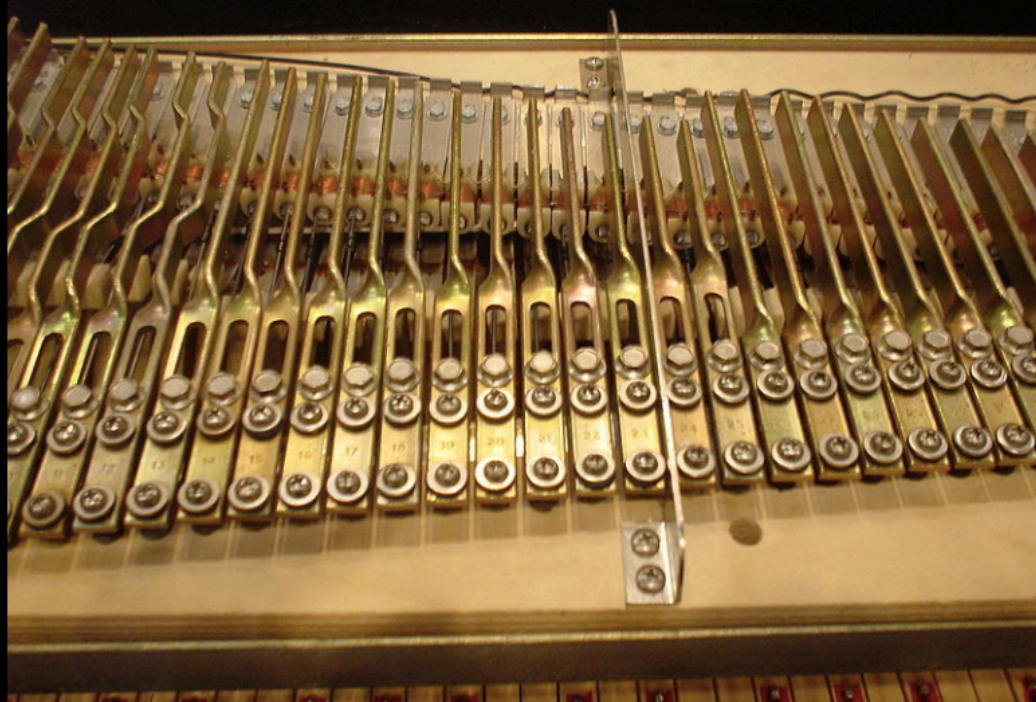

- Rhodes Electronic Piano (1959~1965~1979~)



電子合成器

以物理震動產生電流訊號，經由擴大機發聲的樂器

擁有各式各樣改變音色的參數

- 1950s - RCA Mark I & II

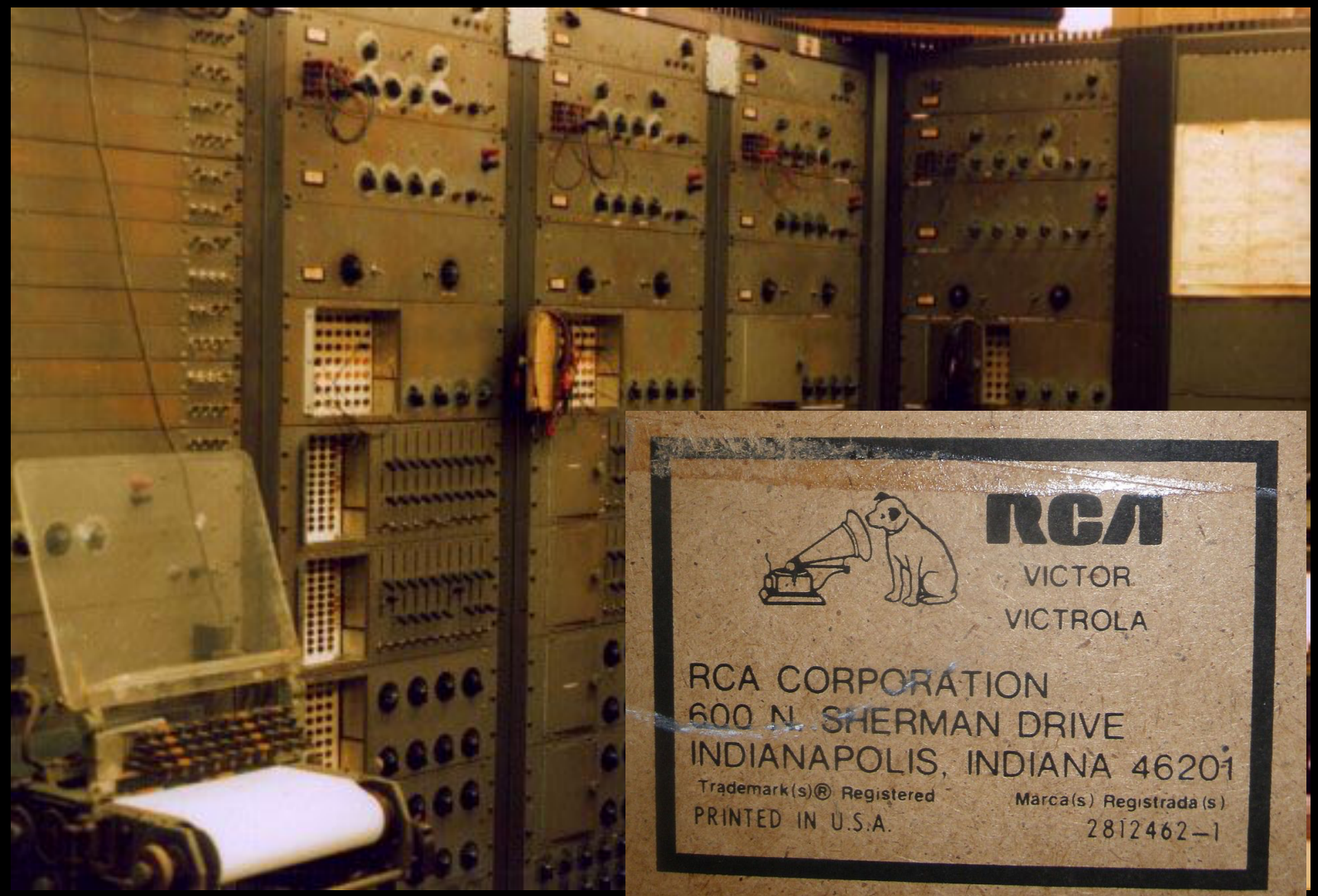

- 1960s - Moog (NY 東岸) , Buchla (Berkeley, California 西岸)

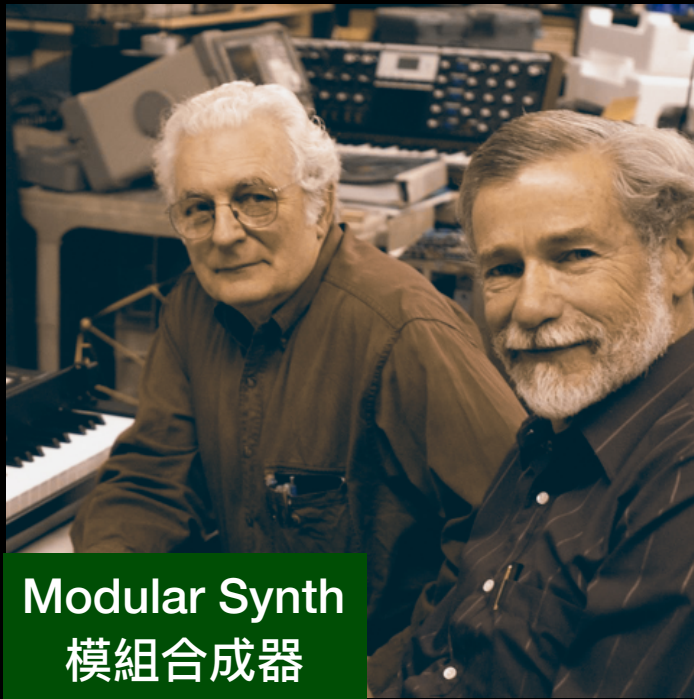

Modular Synth
模組合成器

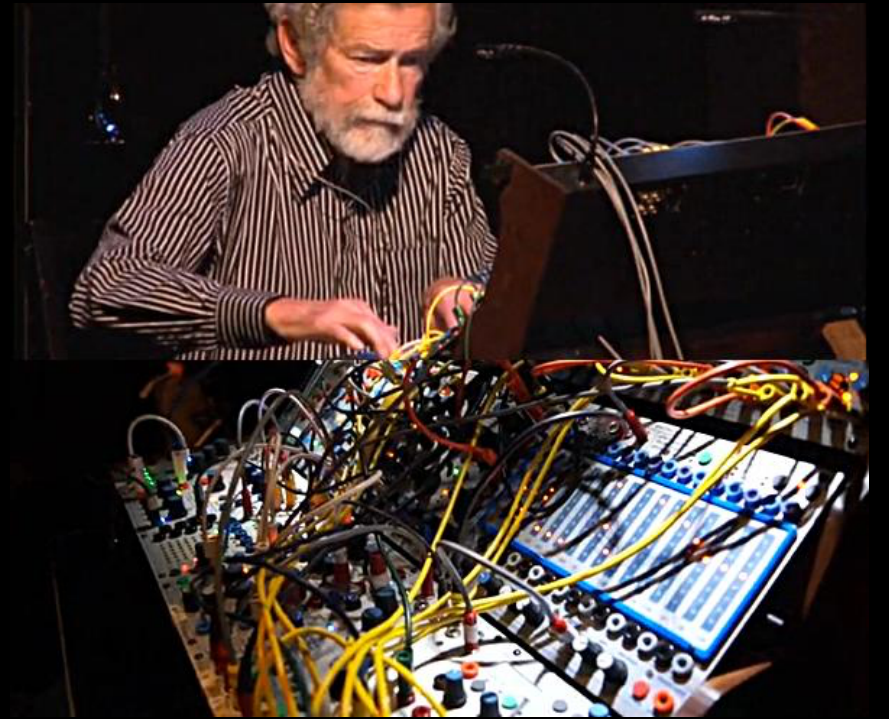
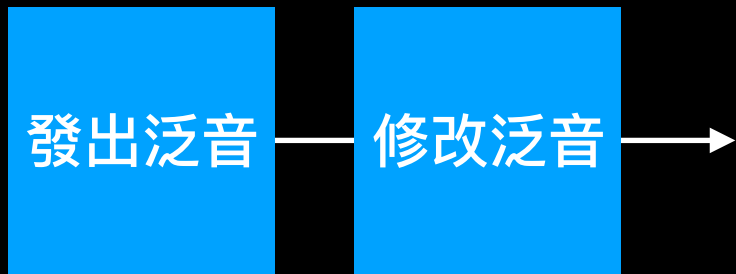

聲音設計取向，以改變泛音源頭為核心



樂器取向，以修改泛音為核心



- 1960s - Moog (NY 東岸) , Buchla (Berkeley, California 西岸)



Modular Synth
模組合成器

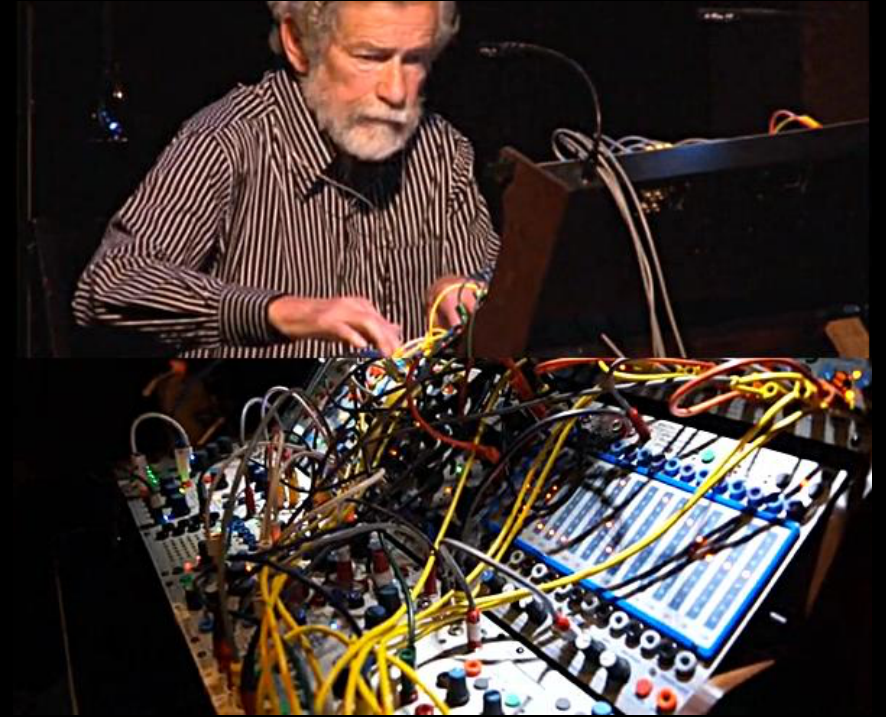

Suzanne Ciani
Alessandro Cortini (Drone)

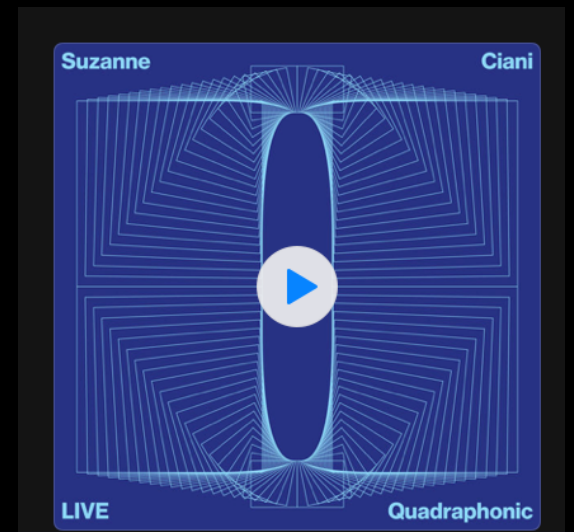

"SWITCHED-ON BACH"
WENDY CARLOS
RELEASED 1968

Isao Tomita - the Planets
富田勳 - 行星組曲
加入更多合成器音色

- 經典 BASS 合成器
- MOOG - minimoog (1970, 2016)



第一台攜帶式鍵盤合成器！！

- Other minimoog - Roland SE-02, Behringer Model D



更多親切的
Minimoog 選項!!

- Arp Odyssey (1972, Korg: 2015)



- Roland SH101 (1982)



- Roland TB-303 (1982)

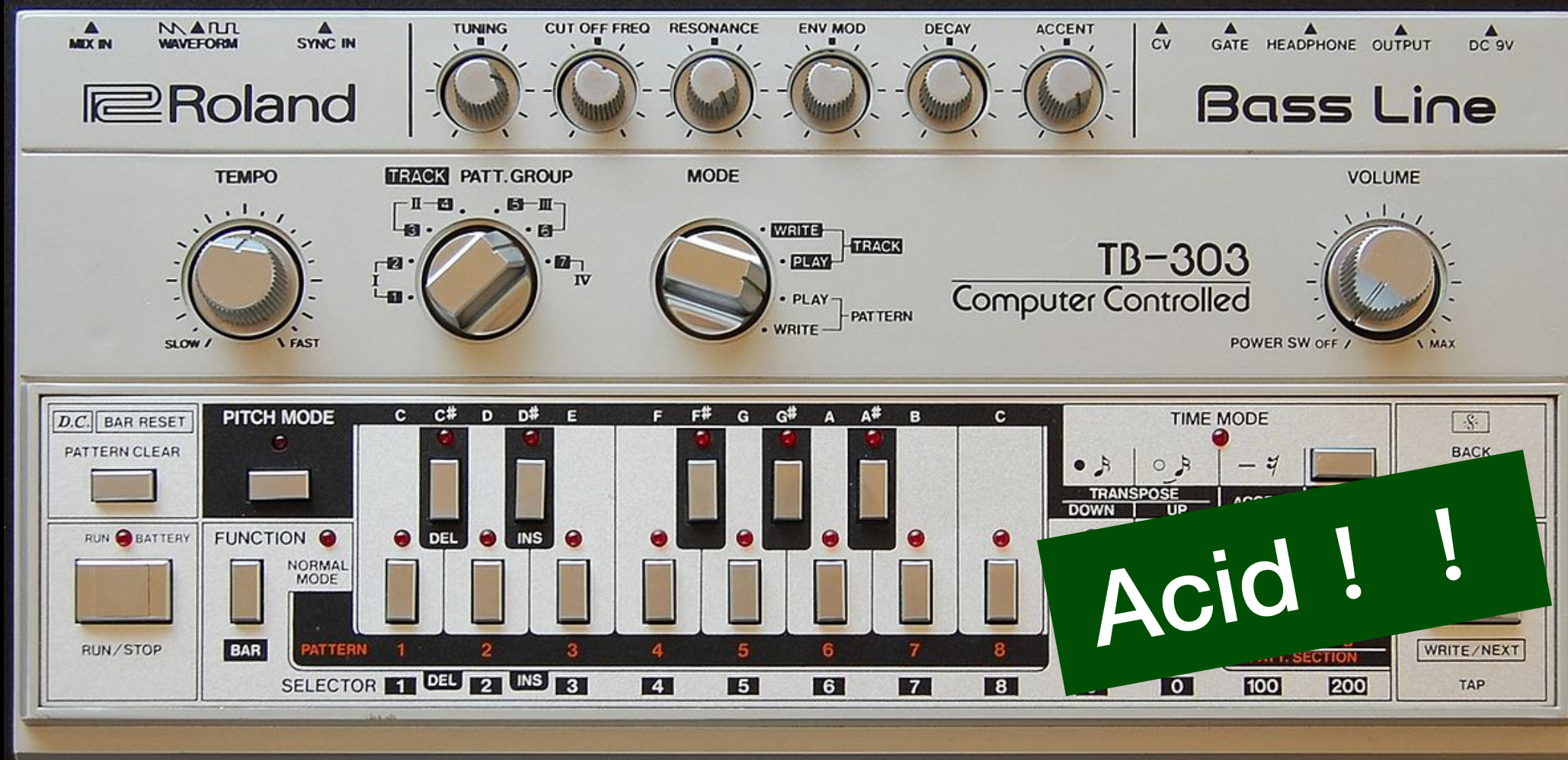

- Oberheim SEM (1974)

STATE VARIABLE FILTER



- 經典多發聲合成器

- Prophet 5, Ob-Xa, jupiter 8 (1978-1981)

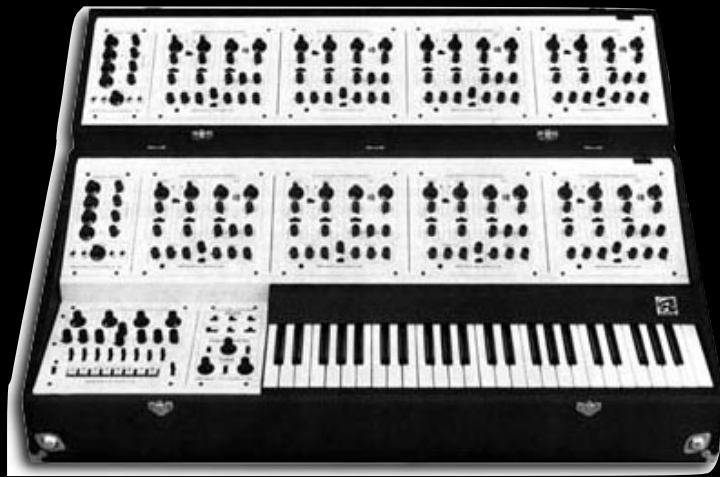

Dave Smith x Tom Oberheim Prophet 6, OB-6



- Korg Mono/Poly, PolySix (1981)



- Roland Juno 6, 60, 106 (1982-84)



多了Preset



Cost Down

- Famous Synthesizers
- YAMAHA CS-80
- (Polyphonic Aftertouch)



Blade Runner

- Famous Synthesizers

- YAMAHA DX-7 - FM Synthesis



FM 合成器 !!!

- Korg M1 - the first Workstation (1988)



第一台工作站！！
iOS 版本！！

入門導聆

20

Warp | IDM

Artificial Intelligence



Artificial Intelligence



Artificial Intelligence II

ALESSANDRO CORTINI
FORSE I II III



Buchla | Drone (ambient)

IMPREC373
IMPREC374
IMPREC418

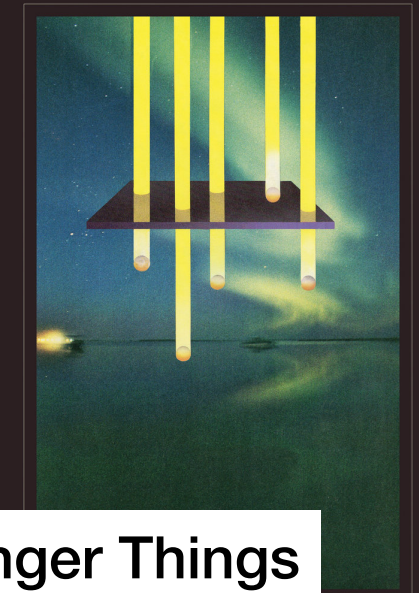

Stranger Things
Synth Wave

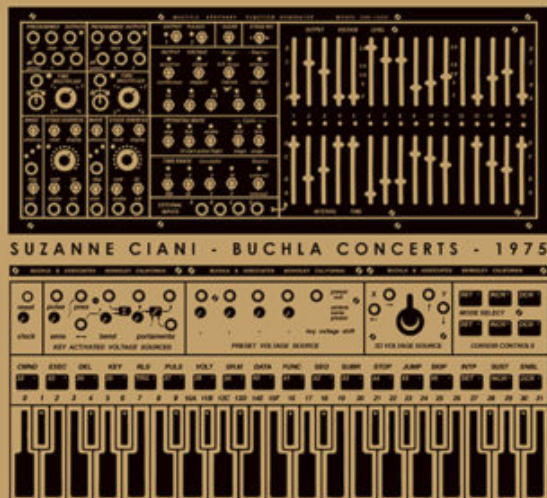

Buchla Live



Richard Devine
Experimental

SNARKY PUPPY
WE LIKE IT HERE

Snarky Puppy
Jazz Fusion

moondawn

klaus schulze



Klaus Schulze
Berlin School

合成器基礎架構

各種合成法共通的發聲方式

MADZINE

VOICE AND UNISON

發聲數與齊奏

- VOICES : 最大發聲數
- Unison (齊奏) : 利用更多發聲數把聲音疊厚
- Detune, Spread, Analog : 將 Unison 中使用的發聲數 Pitch 偏一點點
- Voice Unison / Osc Unison

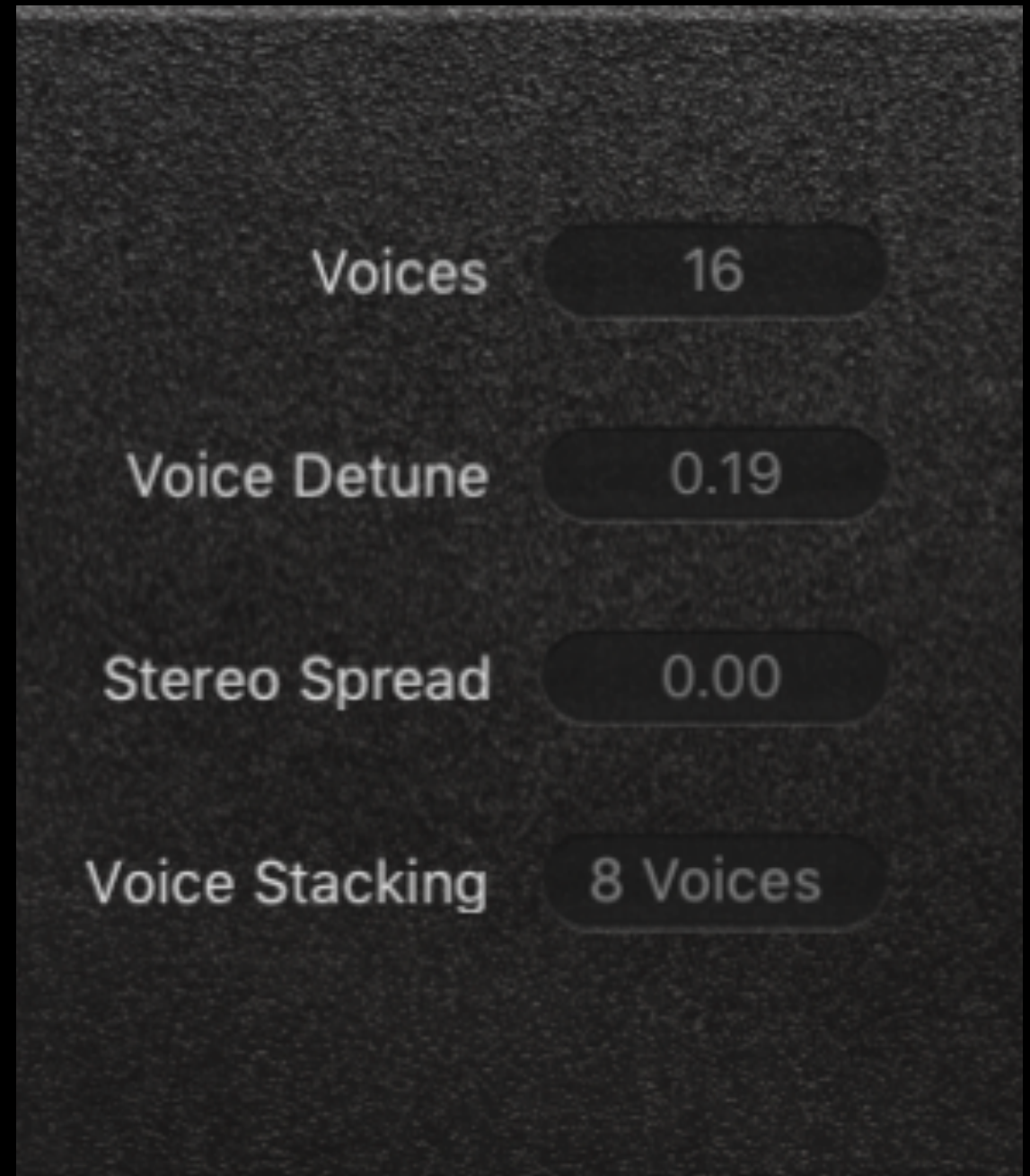

SYNTHESIS

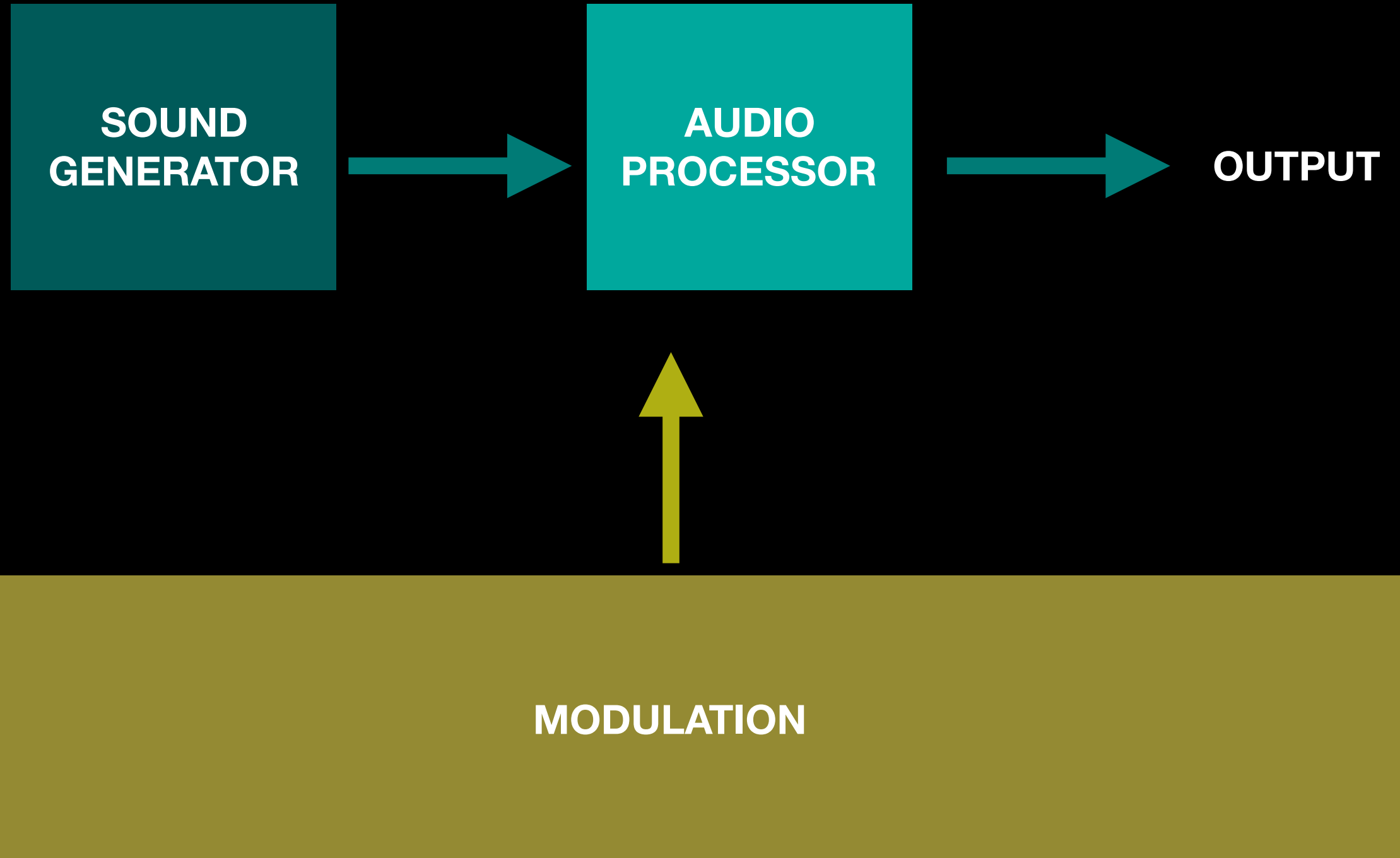

SYNTHESIS

SOUND
GENERATOR



AUDIO
PROCESSOR



OUTPUT



MODULATION



SUBTRACTIVE SYNTHESIS

減法合成

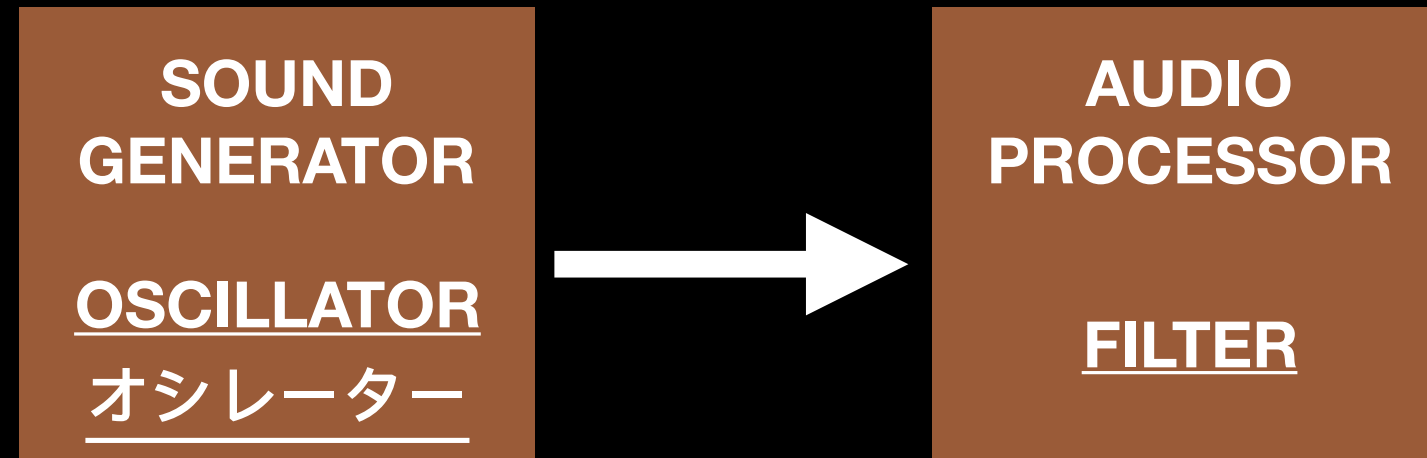

MODULATION SOURCE

Envelope (ADSR), LFO, Sequencer...

Frequency Modulation SYNTHESIS

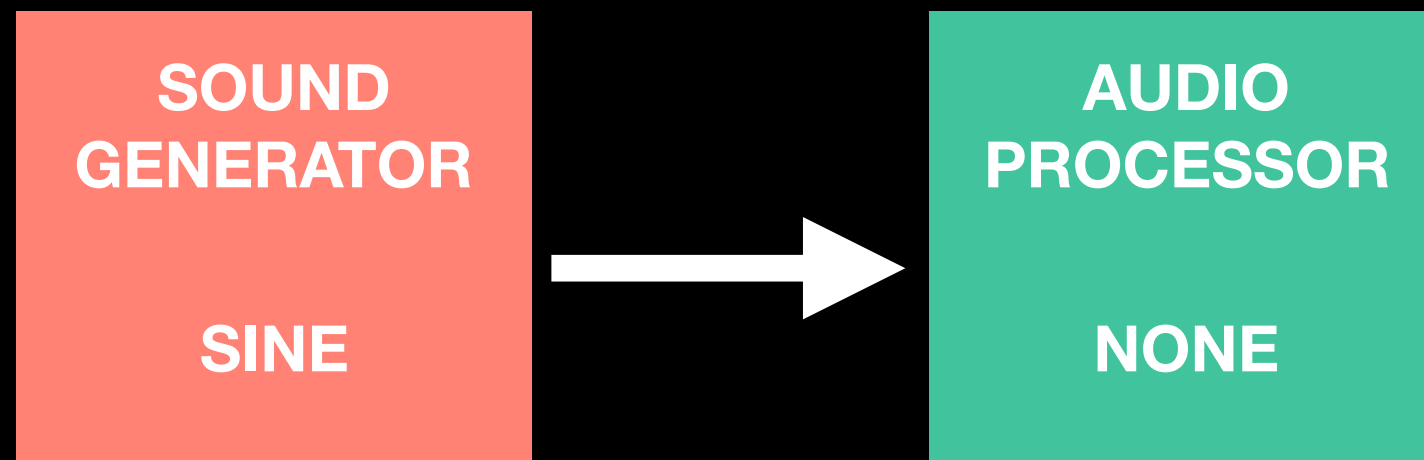

MODULATION SOURCE

SINE, ADSR

MODELING SYNTHESIS

物理建模合成

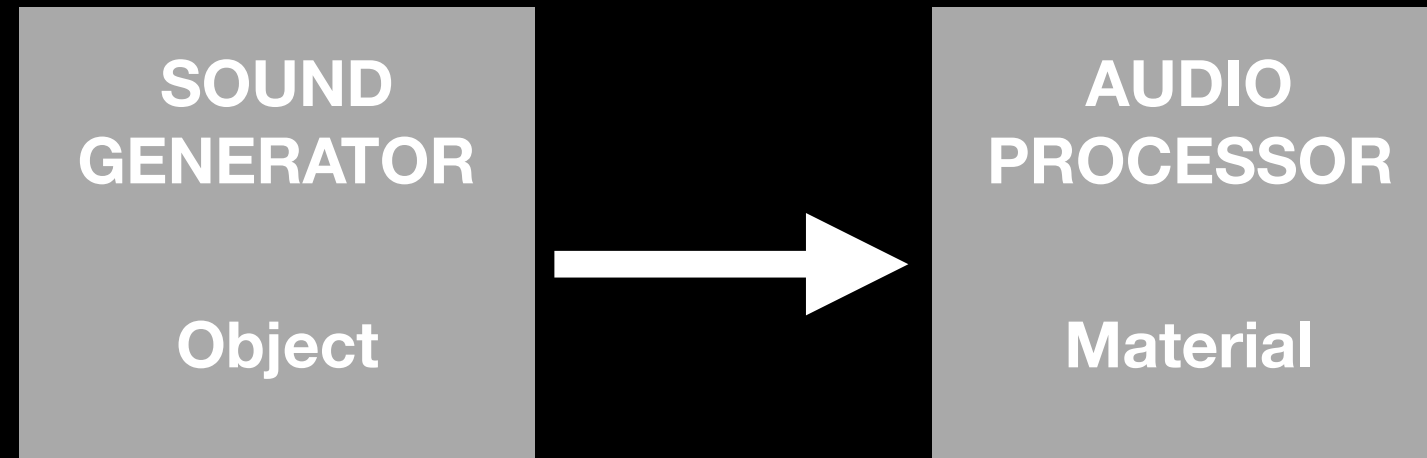

MODULATION SOURCE

Envelope (ADSR), LFO, Sequencer.

GRANULAR SYNTHESIS

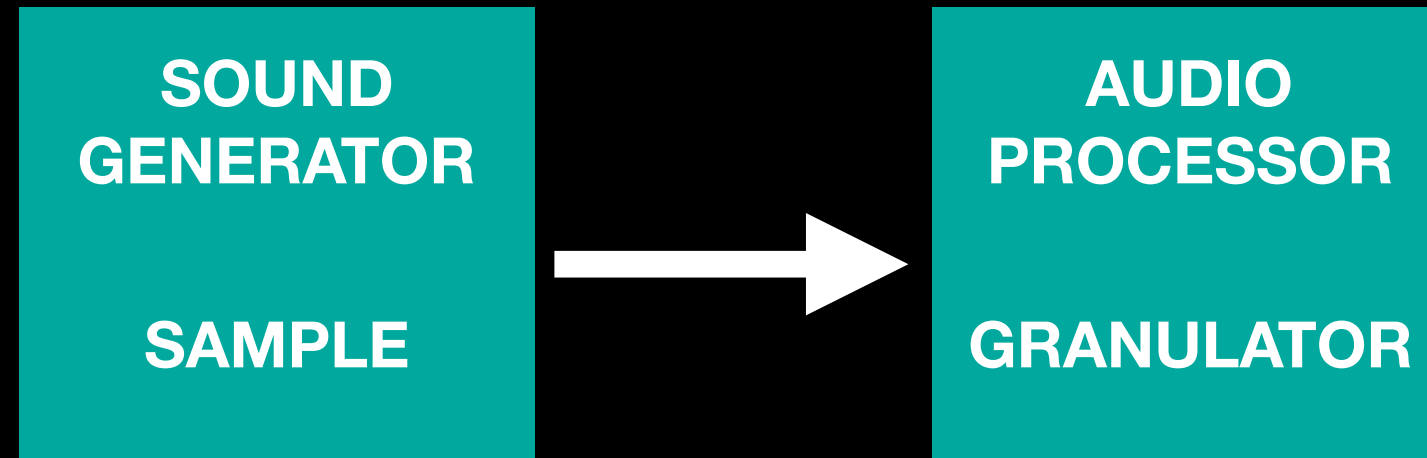

MODULATION SOURCE

Envelope (ADSR), LFO, Sequencer.

Voltage Controlled Oscillator

Voltage Controlled Filter

Voltage Controlled Amplifier

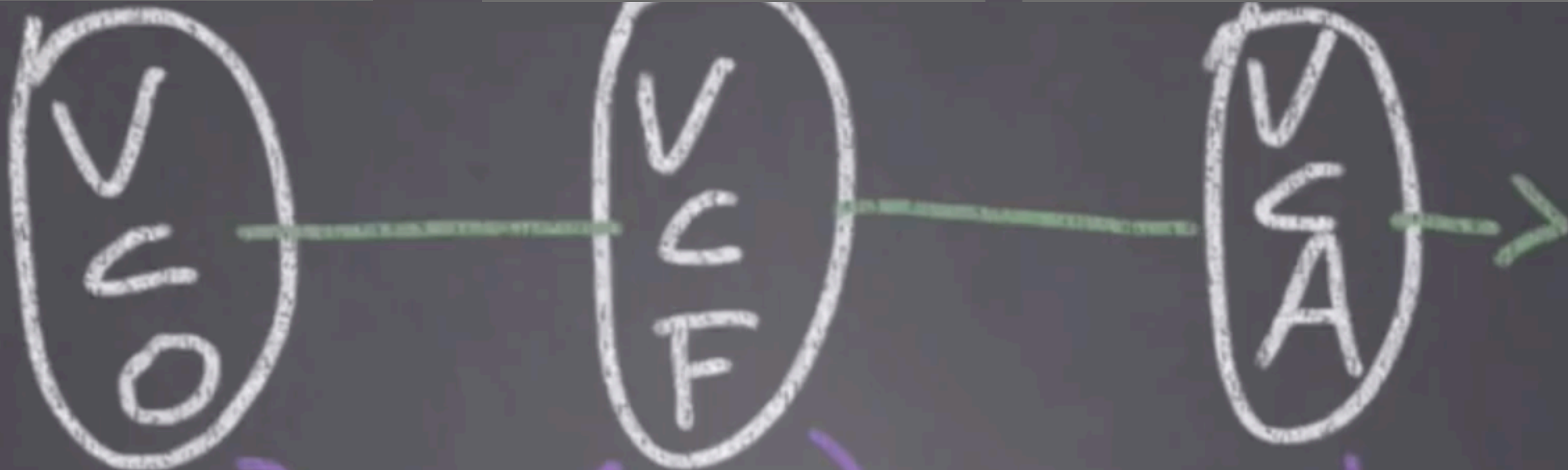

Audio

Modulation Source

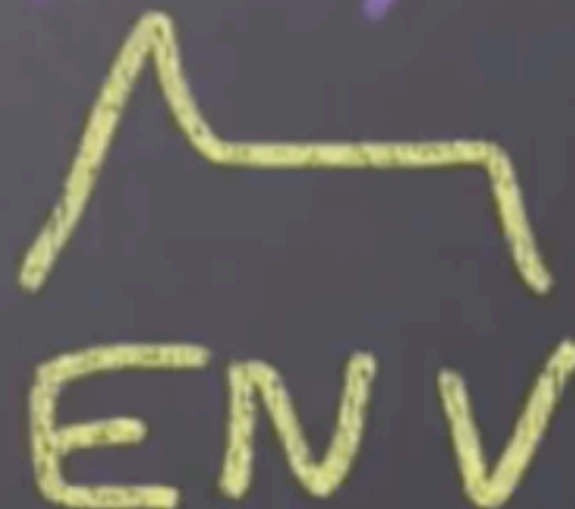
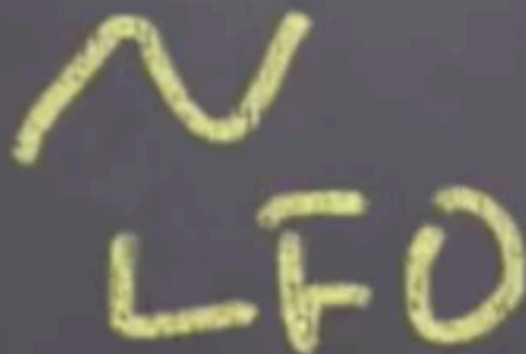
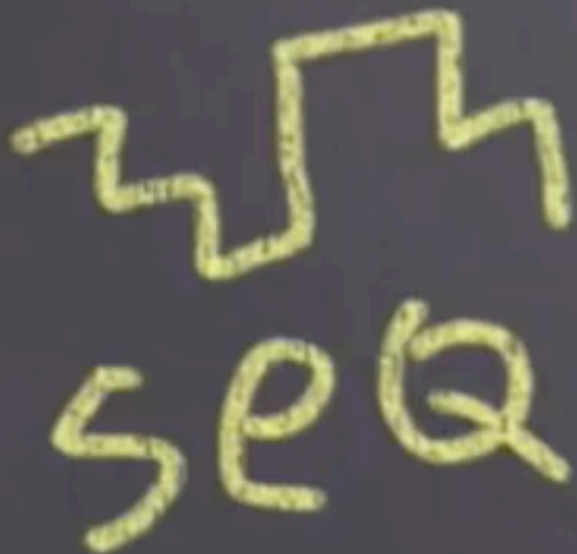

減法合成器簡介

決定聲音的個性、質地

1. 改變波形

2. 改變音高

製造豐富的音色
提供大量泛音

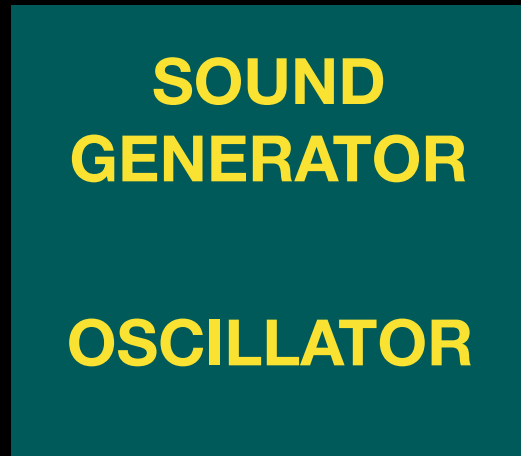

發聲源



音色處理

處理音色亮度

1. 選擇模式

2. 修改亮度

去除音色中不想要的泛音



增加動態

MODULATION

Envelope (A DS R), LFO, Sequencer.

以 A 裝置去控制合成器上的 B 參數
控制源 控制量 控制目標

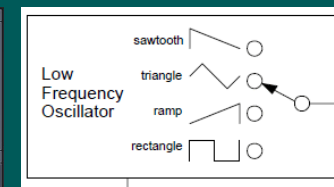

Modulation Source Modulation Amount Modulation Target

一次性

Loop

可自訂路徑的 Loop

合成器規格

- 多發聲、單發聲、平行發聲
- OSC, Filter, AMP (通常只有一個) 有幾個？
- Envelope (ADSR) , LFO, Sequencer 有幾個？
- OSC 的規格
- 合成器組件越多 = 音色變化可以越複雜



多發聲 Polyphonic

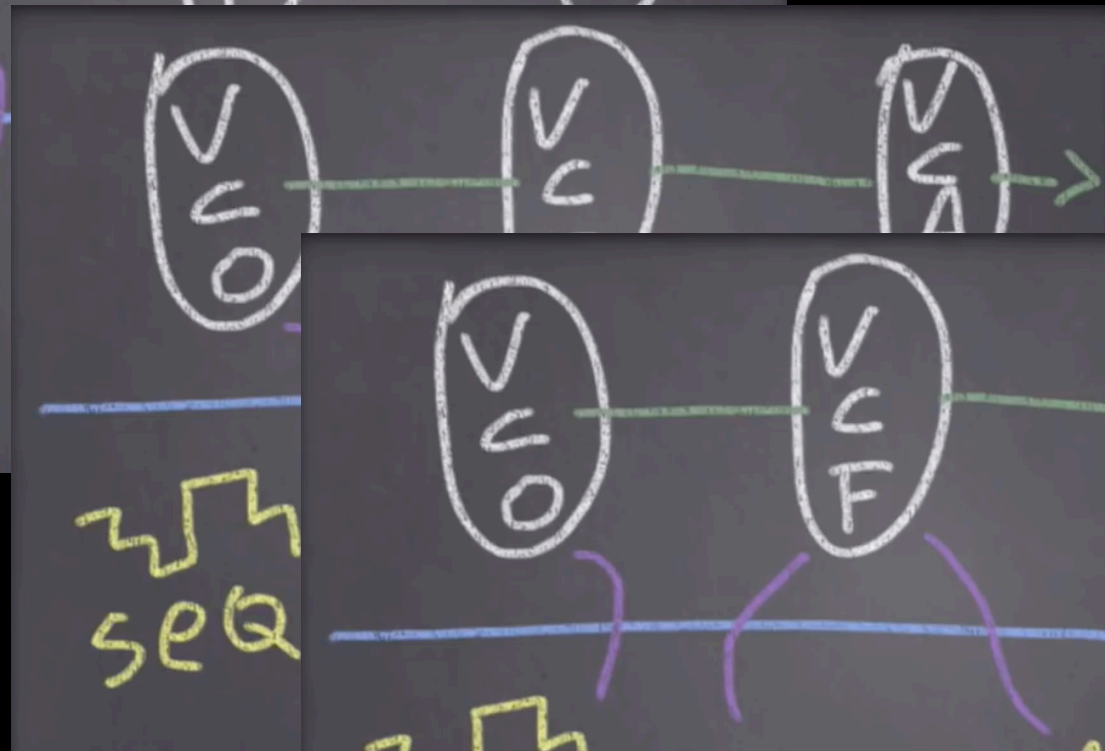
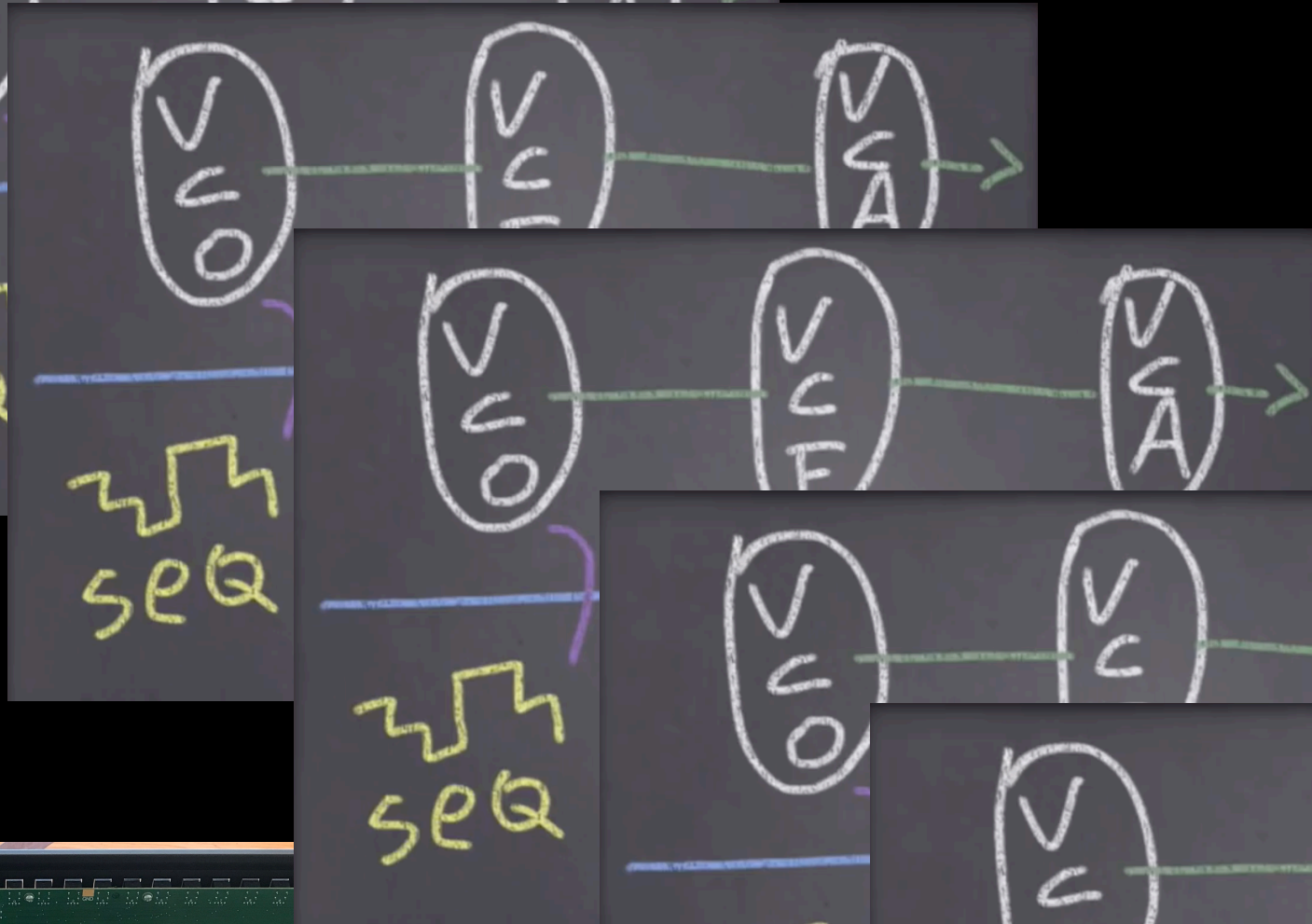
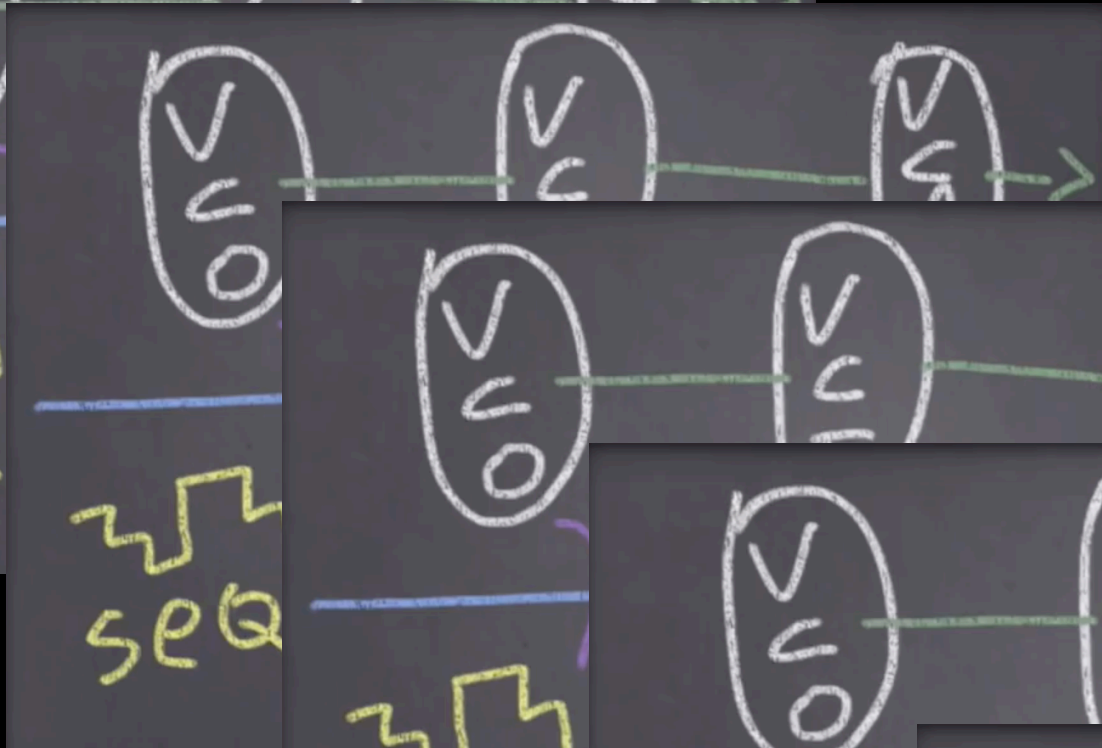
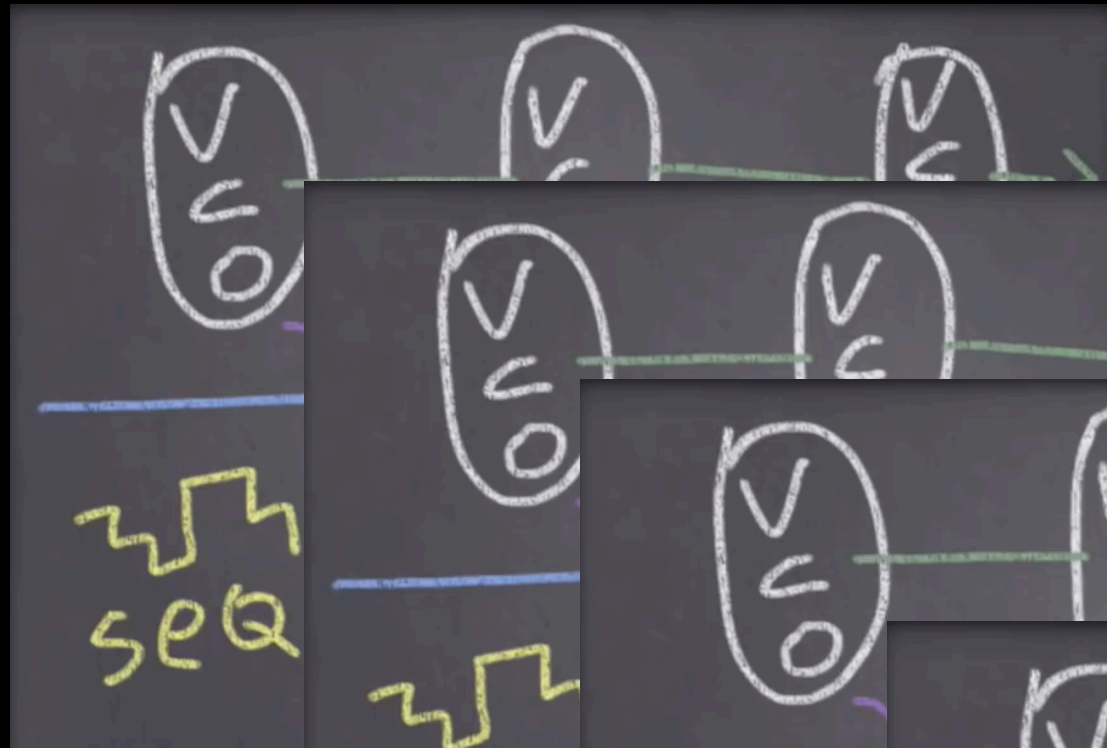

OSCILLATOR
オシレーター

VCA

OSCILLATOR
オシレーター

VCA

OSCILLATOR
オシレーター

VCA

OSCILLATOR
オシレーター

VCA

平行發聲 Paraphonic

FILTER

VCA



MODULATION SOURCE

Envelope (ADSR), LFO, Sequencer...

合成器基礎參數

認識基礎功能與音色分類

減法合成器簡介

決定聲音的個性、質地

1. 改變波形

2. 改變音高

製造豐富的音色
提供大量泛音

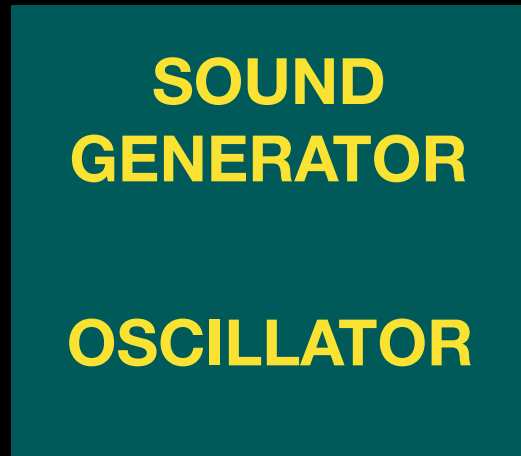

發聲源



音色處理

處理音色亮度

1. 選擇模式

2. 修改亮度

去除音色中不想要的泛音



增加動態

MODULATION

Envelope (A DS R), LFO, Sequencer.

以 A 裝置去控制合成器上的 B 參數
控制源 控制量 控制目標

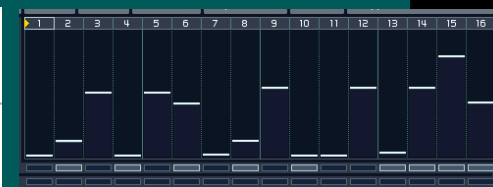
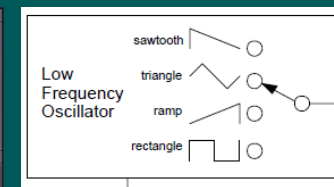

Modulation Source Modulation Amount Modulation Target

一次性

Loop

可自訂路徑的 Loop

減法合成器簡介

決定聲音的個性、質地

1. Wave shape / table, morph

2. Frequency

製造豐富的音色
提供大量泛音

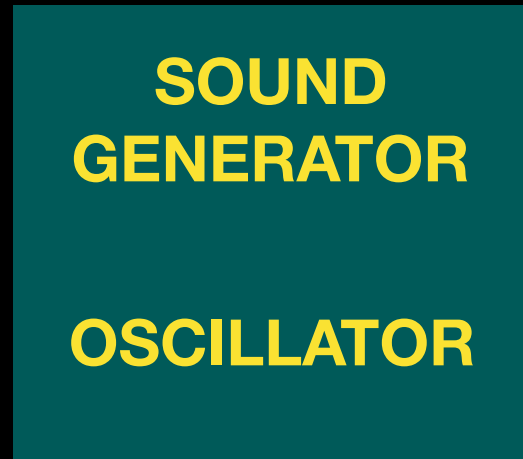

發聲源



音色處理

處理音色亮度

1. Filter mode

2. Cutoff (Filter) Frequency

3. Resonance / Emphasis

去除音色中不想要的泛音



增加動態

MODULATION

Envelope (A DS R), LFO, Sequencer.

以 A 裝置去控制合成器上的 B 參數
控制源 控制量 控制目標

Modulation Source Modulation Amount Modulation Target



一次性

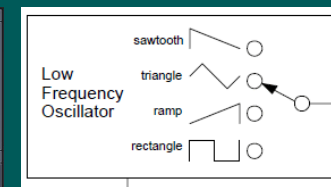

Loop



可自訂路徑的 Loop

減法合成器簡介



增加動態

MODULATION

Envelope (A DS R), LFO, Sequencer.

以 A 裝置去控制合成器上的 B 參數
控制源 控制量 控制目標

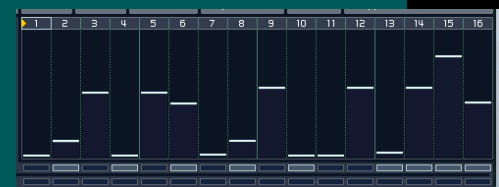
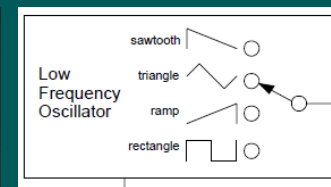

Modulation Source Modulation Amount Modulation Target

一次性

Loop

可自訂路徑的 Loop

Modulation Matrix System

Synthi A



Arturia Matrixbrute



Performance Control



Velocity 力度

音符 / 音高

PitchBend

Aftertouch

Modulation Wheel

Random 隨機

Vel	Note	PB	AT	Mod	Rand
50					
		2			
				100	

常見音色分類

- BASS - 低八度、單音
- KEY, CHORD - 快、尾音短
- PAD - 漸強慢、尾音長
- LEAD - 大、單音、快、滑音
- SEQUENCE - 有節奏感、Loop
- SE / FX - 效果音、沒有音高
- Drum / Percussive - 節奏樂器

Category	Subcategory
All	All
Arpeggiated	Bell
Bass	Layered
Brass	Wood
Drums	
Guitars	
Keys	
Leads	
Mallets	
Organs	
Pads	
Rhythmic	
Sound Effects	
Soundscapes	
Strings	
Synths	
Vocals	
Woodwinds	

Amp Envelope Generator

認識用 ADSR 控制音量與編曲位置的關聯

A3

A4



Glide / Portamento / Slew 是一種把前一個訊號維持住，讓下一個訊號進來的時間變慢的參數，我喜歡稱這件事做：把直的音高扳成彎的

Hold

note
on

note
off

按下一個琴鍵時，可以得到「按下琴鍵 | 維持音長 | 放開琴鍵」這三段訊息，
我們把他們叫做一組 GATE 訊號

Hold

note
on

note
off

由於這個方形的動態太無聊了，[Envelope Generator] 就是被設計來把這個無聊的動態扳彎的工具，通常有 A、DS、R 三個階段

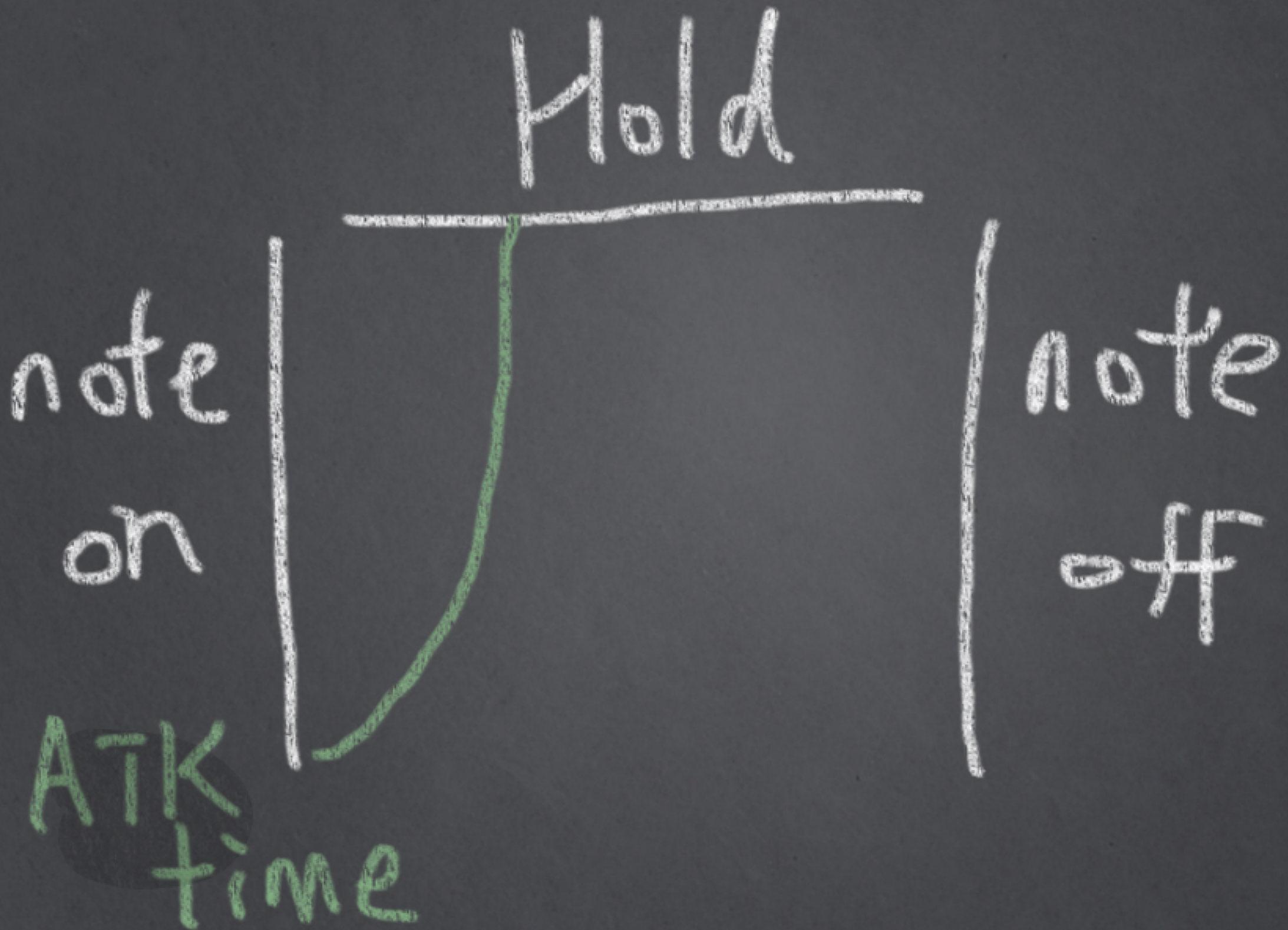

於是將一組 GATE 訊號送進 Envelope 時，
Attack Time 會將 Note on 到最高點 Hold 的時間減慢

Hold

note
on

ATK
time



note
off

Release
time



而相對於 Attack Time ,
Release Time 則會將 Note off 後的時間減慢



Decay Time 與 Sustain Level 則用來把原本筆直的 Hold Level 往下扳彎



於是說到 Envelope 究竟是什麼？其實就是把一組 (通常是由琴鍵產生的) **Gate 訊號** 中的三個訊息，利用 **A.DS.R** 四個參數扳彎的一個機器。簡稱 **GATE 扳彎機** (亂來)

ENVELOPE

- note on : attack time
- decay time - sustain level
- note off : release time
- velocity



ENVELOPE

- **note on** : attack time 音符開始後，音量到達最大值的時間
- decay time - sustain level 音量到達最大值後（Attack time 之後），會經過 decay 時間衰減到 sustain 音量
- **note off** : release time 音符結束後，音量到零的時間
- velocity



音色與編曲位置- 使用 ADSR 解釋

- **BASS** - 從 MIDI Note 設計
Decay, ASR 可以是 0
- **KEY, CHORD** - 有 Sustain、多
發聲數的 Bass 音色
- **PAD** - 仔細設計 AD、調整發聲
數
- **LEAD** - 利用 DS 設計 Punch

Category	Subcategory
All	All
Arpeggiated	Bell
Bass	Layered
Brass	Wood
Drums	
Guitars	
Keys	
Leads	
Mallets	
Organs	
Pads	
Rhythmic	
Sound Effects	
Soundscapes	
Strings	
Synths	
Vocals	
Woodwinds	

設計 A | DS | R 的思維

- 這個 ENV 有沒有完整表達 MIDI 音符的長度
- 如果是長音，有沒有對應速度調整 A / D 的長度
- 如果是短音，有沒有用DS做出動態 (Punch / Dynamic)
- 使用一點點 Attack 做出比較軟的觸鍵 (Touch)
- 設計對應譜面的發聲數

Category	Subcategory
All	All
Arpeggiated	Bell
Bass	Layered
Brass	Wood
Drums	
Guitars	
Keys	
Leads	
Mallets	
Organs	
Pads	
Rhythmic	
Sound Effects	
Soundscapes	
Strings	
Synths	
Vocals	
Woodwinds	

編曲練習 (1)

只使用 String / PAD 音色透過調整 ADSR 變成不同樂器分類

Arp Solina String Ensemble

1973

monophonic Cello, Bass / polyphonic (Divided) String



Roland RS-09 String / Organ

1979

4 band - Organ,
High / Low String,
Chorus / Vibrato





於是說到 Envelope 究竟是什麼？其實就是把一組 (通常是由琴鍵產生的) **Gate 訊號** 中的三個訊息，利用 **A.DS.R.** 四個參數扳彎的一個機器。簡稱 **GATE 扳彎機** (亂來

常見音色分類 - 使用 ADSR 解釋

- **BASS** - 從 MIDI Note 設計
Decay, ASR 可以是 0
- **KEY, CHORD** - 有 Sustain、多
發聲數的 Bass 音色
- **PAD** - ADR 長、Sustain 不為 0
- **LEAD** - 利用 DS 設計 Punch

Category	Subcategory
All	All
Arpeggiated	Bell
Bass	Layered
Brass	Wood
Drums	
Guitars	
Keys	
Leads	
Mallets	
Organs	
Pads	
Rhythmic	
Sound Effects	
Soundscapes	
Strings	
Synths	
Vocals	
Woodwinds	

編曲練習 (1)

142bpm

只使用同一台合成器

只使用同一種音色

必須要是 Pad / String 類 Preset

只能動 Amp Envelope 和 Level

可以調整發聲數

有多餘的效果器可以關掉或調小

不能加其他效果器

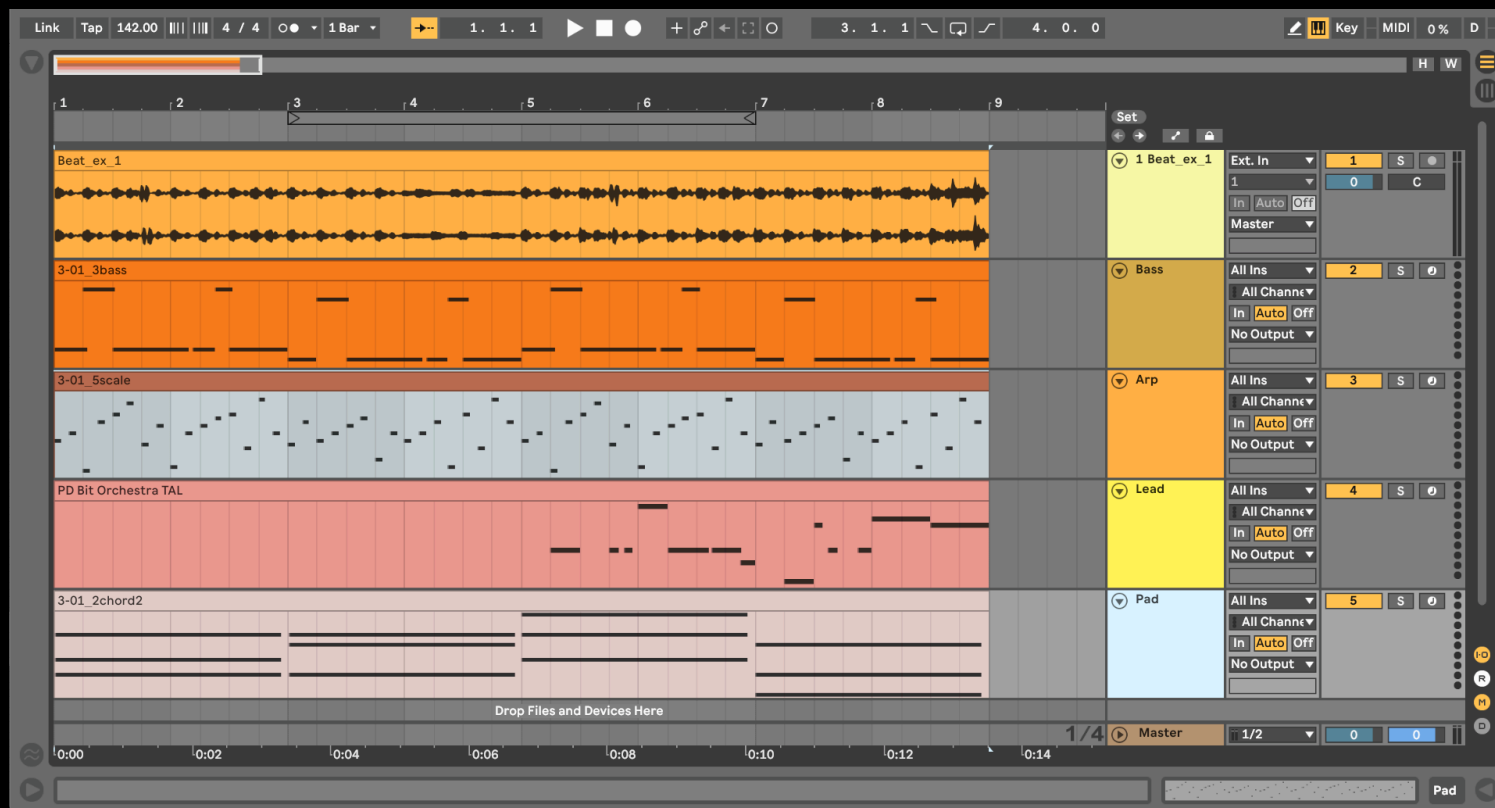

設計泛音

Wave shape, Morph, 與 Pitch 能產生的 OSC 效果

OSCILLATOR
オシレーター

WAVE SHAPE - TABLE - MORPH

FREQUENCY - SYNC, RING, ..

SOME COMMON WAVESHAPES

One period of each waveshape is shown

wave1 : Triangle

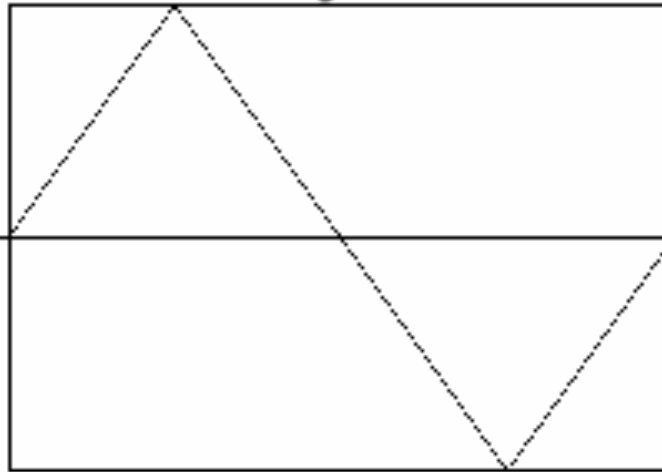

wave2 : Saw-Triangle

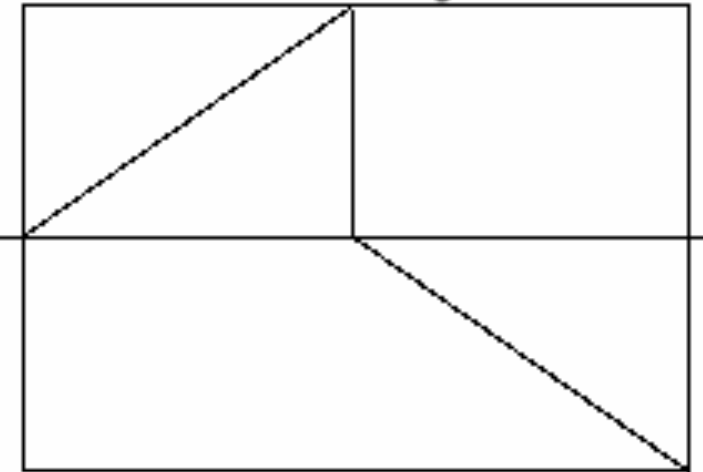

wave3 : Saw

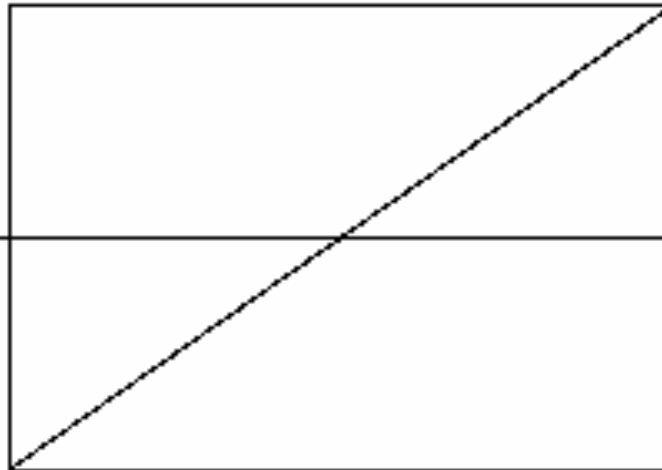

wave4 : Square



wave5 : Wide Pulse

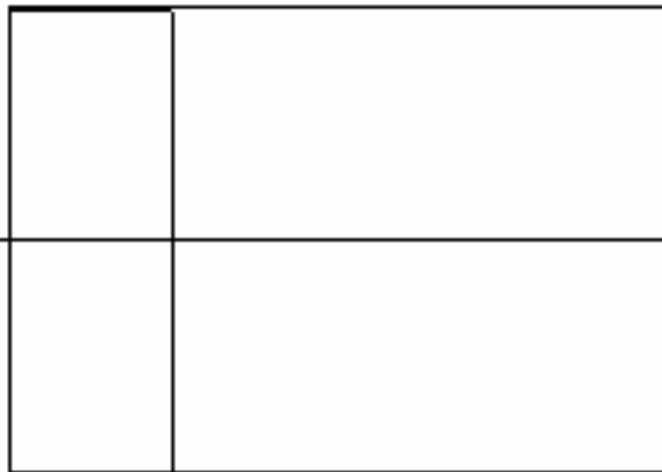

wave6 : Narrow Pulse



WAVE SHAPE

sawtooth

pulse

triangle

sine

SAWTOOTH

有所有整數倍的泛音

super-saw

ultra-saw

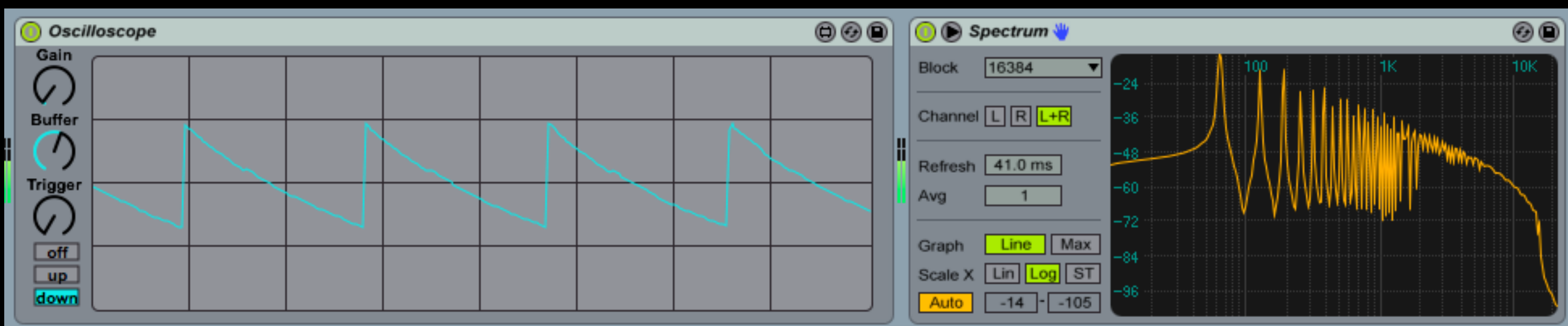
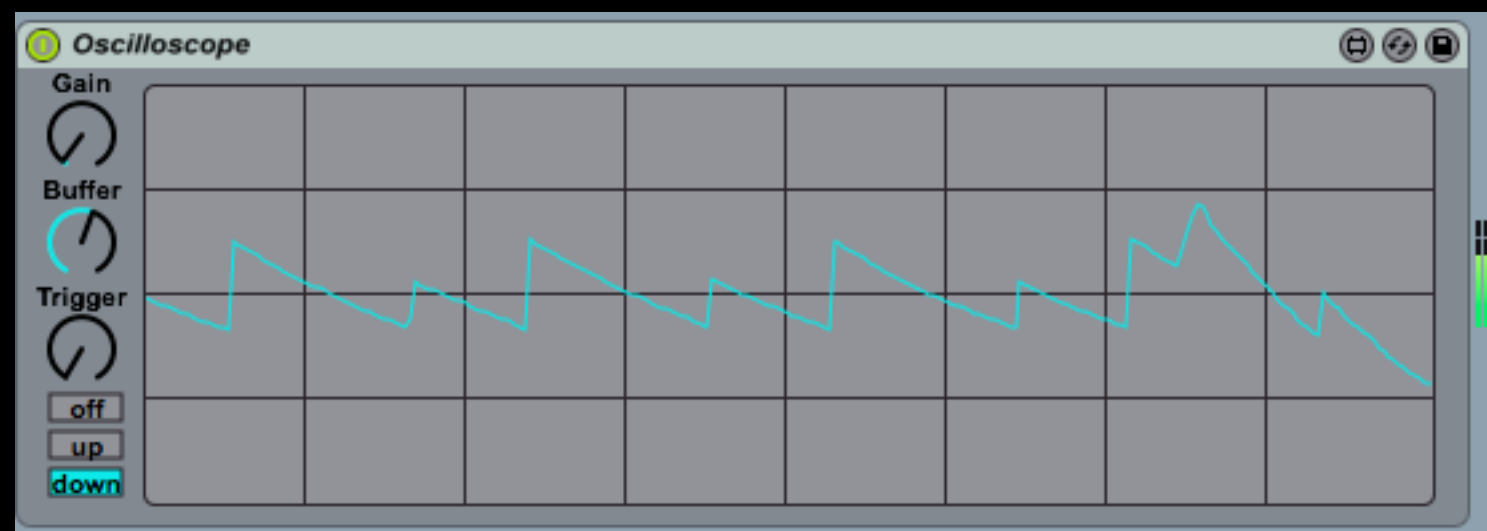

PULSE

pulse width

square - 只有奇數倍的泛音

Pulse width modulation (PWM)

單 OSC 合成器必備!!

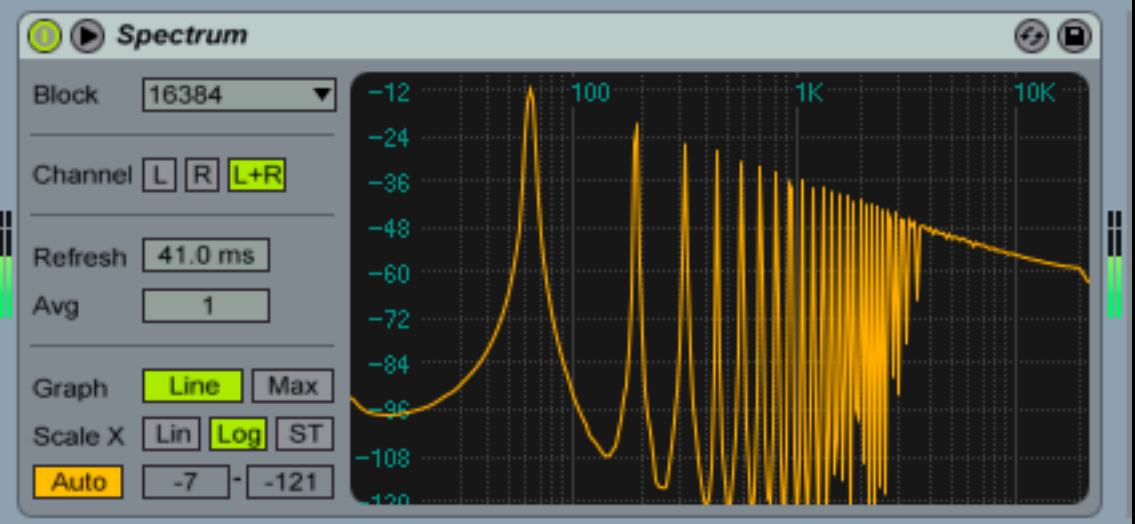
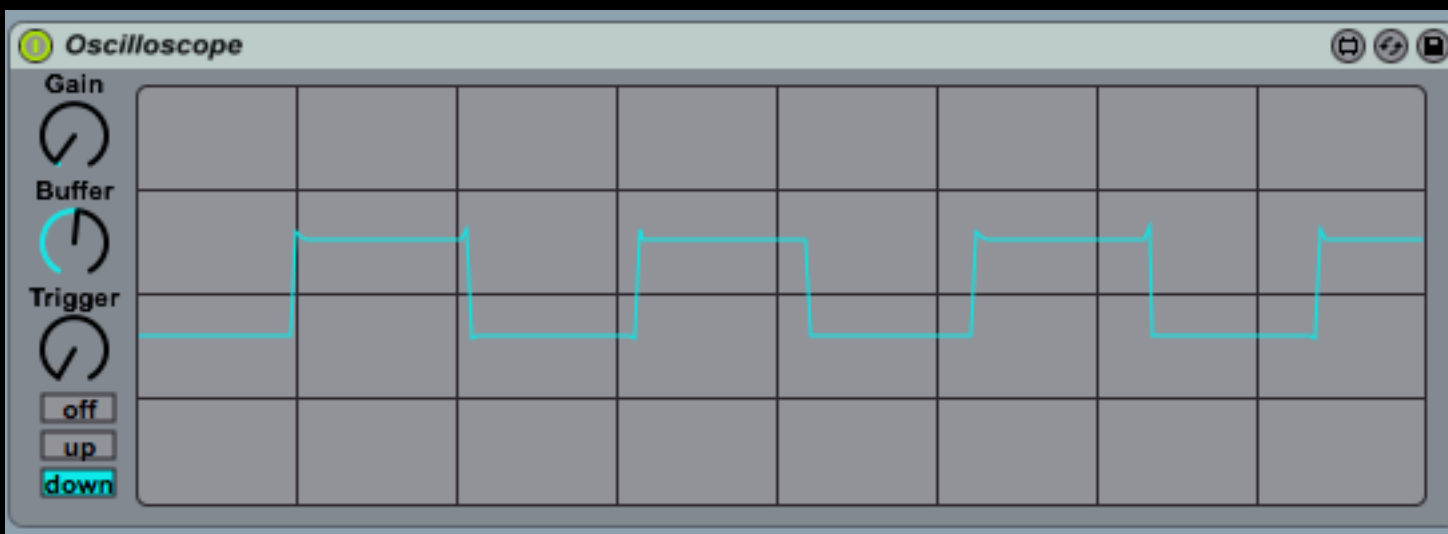
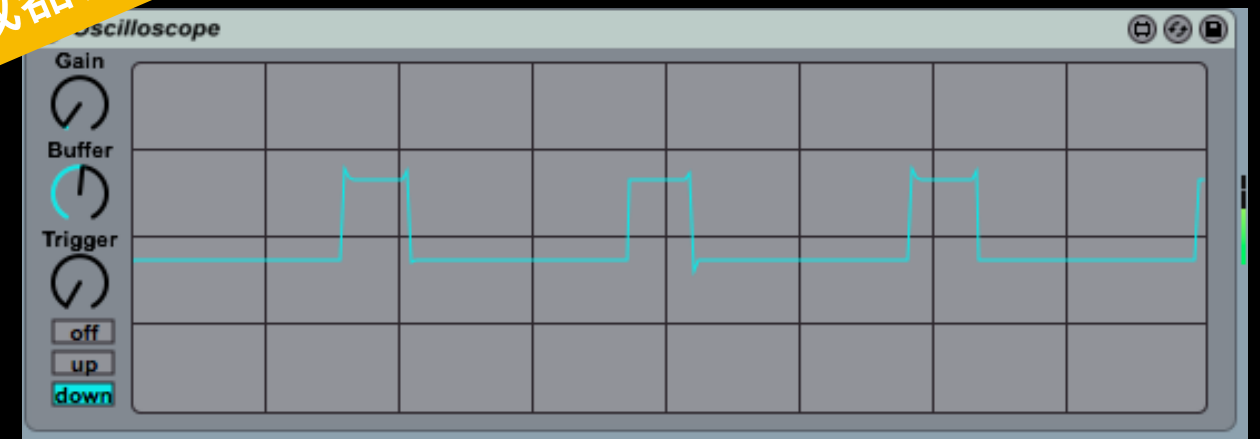
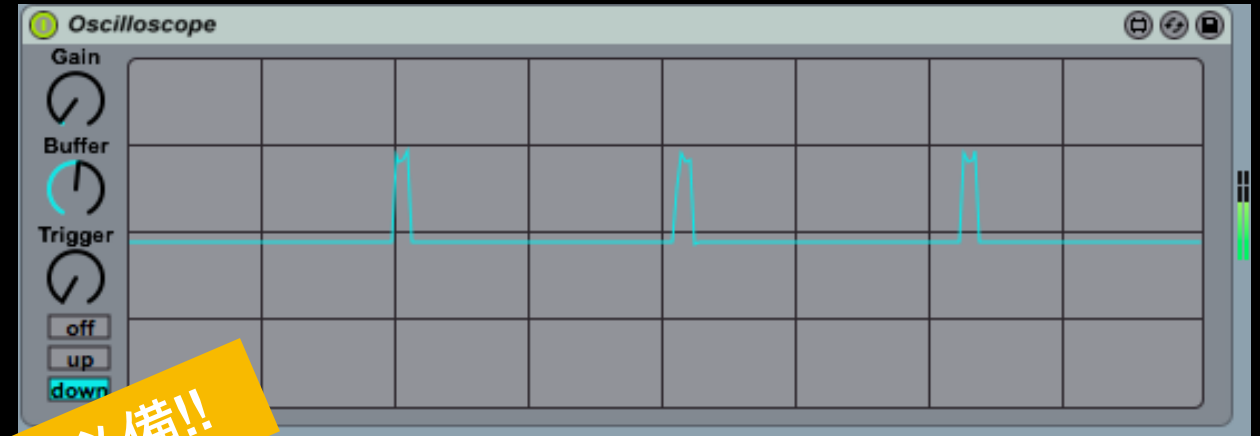

TRIANGLE 只有奇數倍的泛音，泛音量極少

SINE 沒有泛音

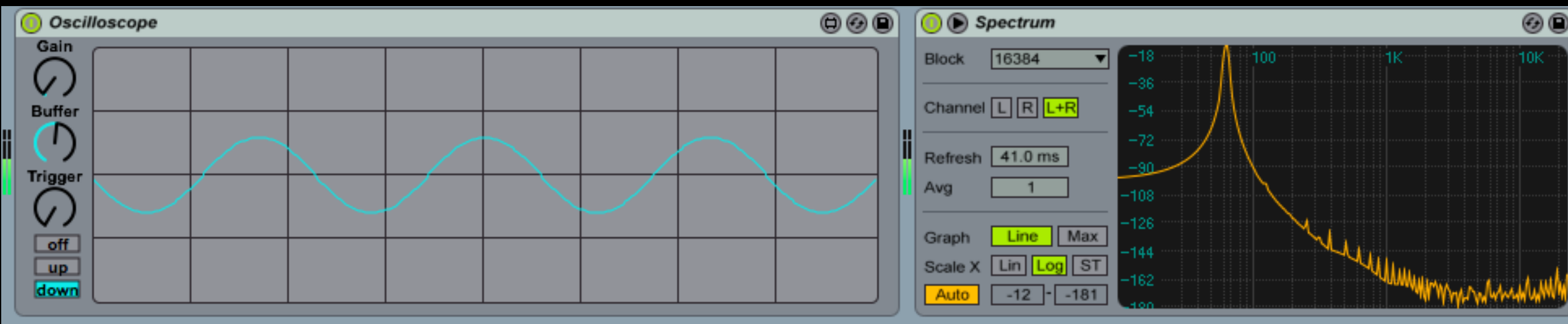
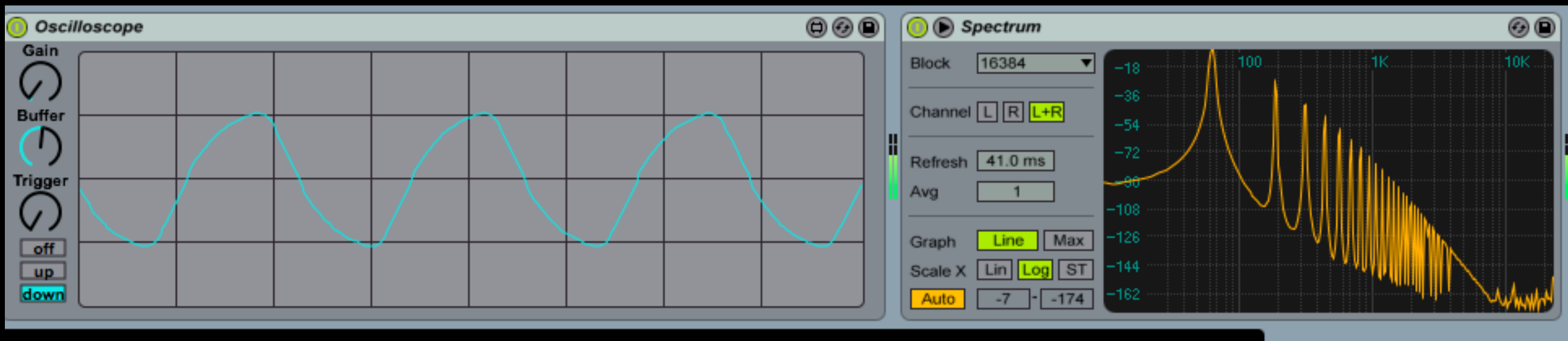

SUB OSC

“附屬的”OSC

通常會低八度

有時候可以換波型

有時候可以選擇低幾個八度

但是沒有獨立的音高可調整



NoiseMaker
低兩個八度的 Square

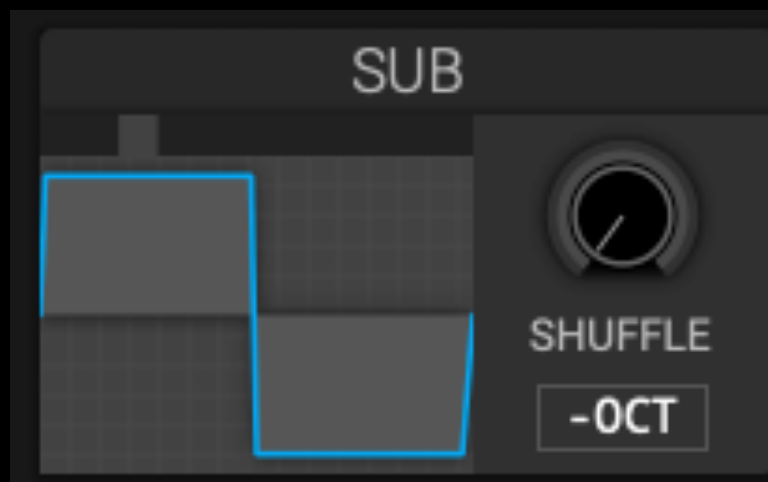

Helm
可換波型、Morph、
低一或二個八度



Serum
波型、八度、
八度音域從正4到負4、
可調左右與直接輸出是特色



Ableton Live Wavetable
Tone 可以讓波型
從 Sine 變成 Square，
音準可以持平也很特別

MORPH

SAW - Supersaw

PULSE - Pulse Width

TRIANGLE - Metalizer

SINE - Fold

Arturia mini brute



Sine

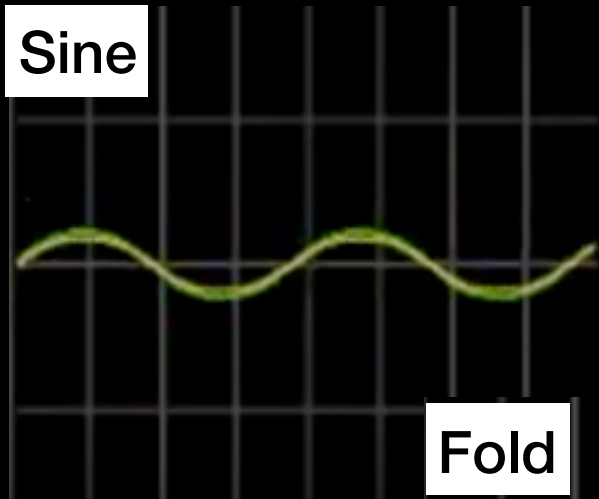

Fold

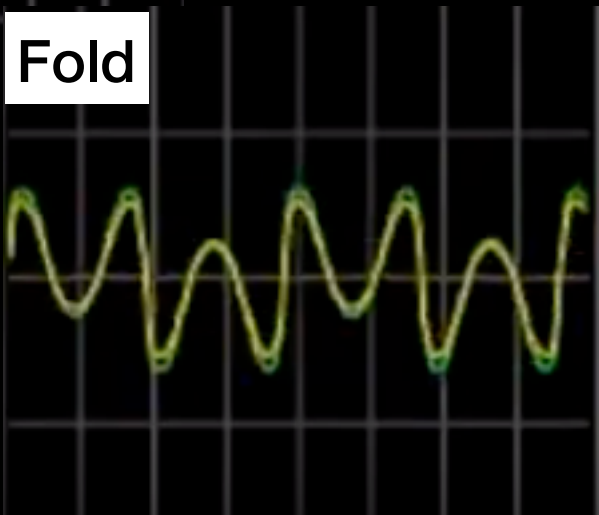

Triangle

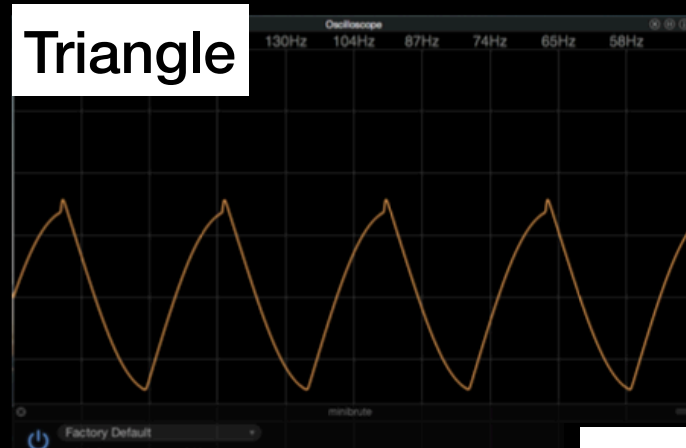

Metalizer

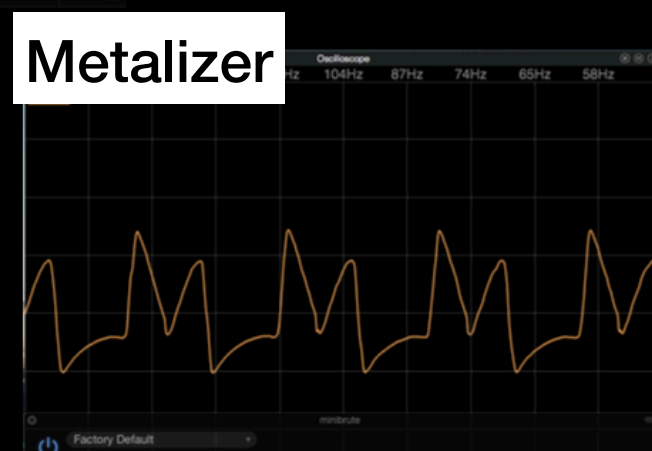

WAVETABLE

Wavetable Position

Warp: Bend+/-, Fold, PWM,.....

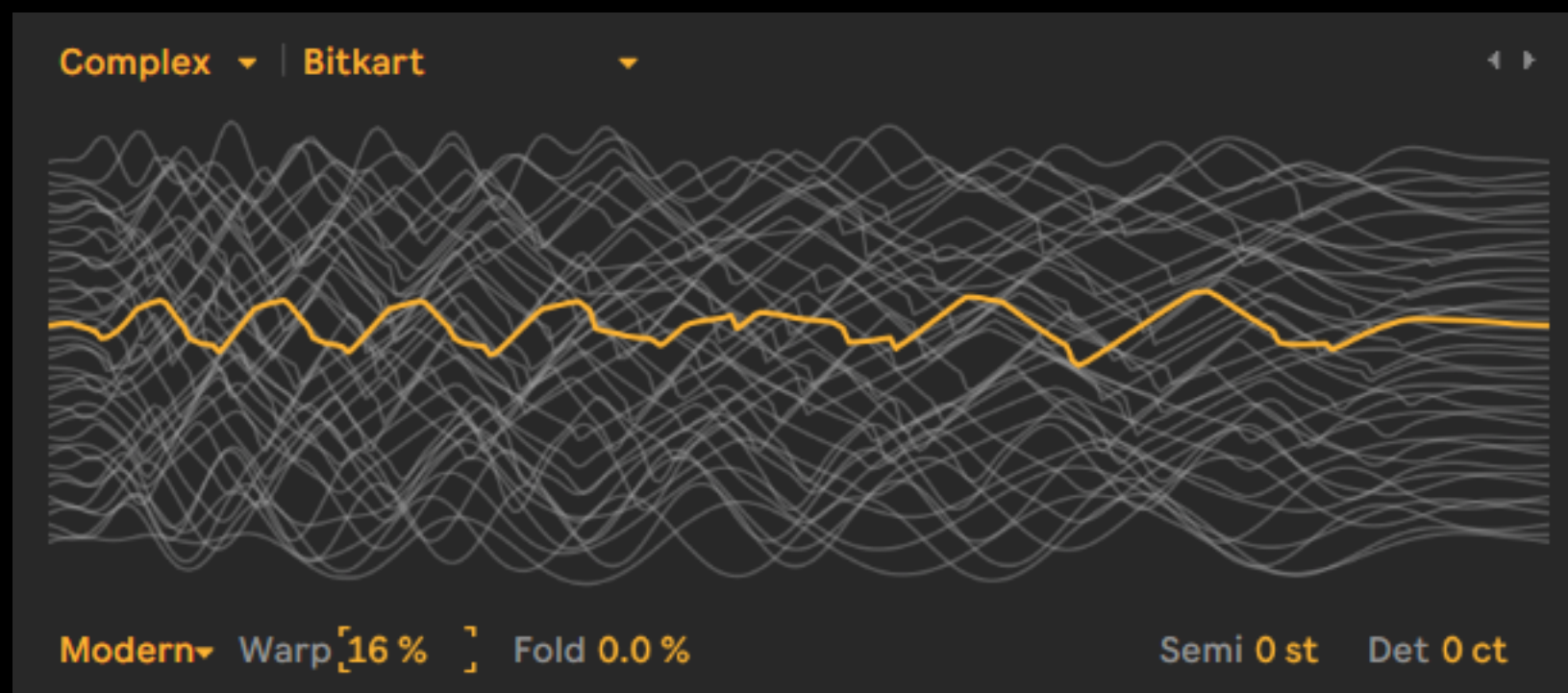

OSC A

Monster 7 [SL]

OCT 0 SEM 0 FIN 0 CRS --

100

UNISON DETUNE BLEND PHASE RAND

WT POS OFF PAN LEVEL

OSC B

Evol Longreece

OCT 0 SEM 0 FIN 0 CRS --

UNISON DETUNE BLEND PHASE RAND

WT POS MIRROR PAN LEVEL

WAVETABLE SYNTH 名機

The Serum VST interface is shown with the following sections:

- OSC A:** Includes a 3D wavetable browser, unison settings (3 voices), and various modulation parameters like detune, blend, and phase.
- OSC B:** Similar to OSC A, with its own set of modulation and unison controls.
- FILTER:** Features a 'MG Low 12' filter with a frequency response graph and controls for cutoff, resonance, and pan.
- ENV:** Envelope section with four stages (Attack, Hold, Decay, Sustain, Release) and a 'FATTNESS' parameter.
- VELO:** Velocity control section with 'MONO' and 'POLY' options.
- KEYBOARD:** A standard piano keyboard at the bottom.

This view shows more detailed parameters for the oscillators and filter:

- Osc 1:** Set to 'Formant' with 'VOSM' modulation. Includes gain (-6.0 dB), tone (39%), and octave (0) settings.
- Osc 2:** Set to 'Vintage' with 'JUP SawPulse' modulation. Includes gain (-5.6 dB) and tone (41%) settings.
- Env 1-3:** Three envelope stages with 'Time Slope Value' graphs.
- LFO 1-2:** LFO sections with 'Rate', 'Amount', 'Shape', and 'Offset' controls.
- Wavetable:** A grid showing target parameters for Osc 1 and 2, including Amp, Env, LFO, and Filter settings.

The Massive VST interface displays multiple oscillators and filters:

- Osc 1-3:** Three oscillators with individual 'Pitch', 'Intensity', and 'Amp' controls.
- Filter 1-2:** Two filter sections with 'Cutoff', 'Resonance', and 'Stream' parameters.
- MIX:** A central mixing section with 'Ring', 'Dry/Wet', and 'Size' controls.
- FX:** Effects section with 'Reverb' and 'Delay' parameters.
- MONITOR:** A spectrum analyzer and waveform display.

The Korg Electribe Wave VST interface is shown on a tablet, featuring:

- MIXER:** Controls for 'MIXER', 'SOUND', 'SEQUENCE', 'MOTION', and 'UTILITY'.
- OSCILLATOR:** Includes 'TRIGGER', 'GATE', 'TRANSPOSE', and 'POSITION' controls.
- MODULATION:** 'MODULATION 1' section with 'SPEED', 'DEPTH', and 'SHAPE' parameters.
- EQUALIZER:** 'EQUALIZER' section with 'LOW', 'HIGH', and 'MOD DELAY' controls.

The Massive X VST interface shows detailed envelope and gate settings:

- Envelope:** 'Standard Envelope' section with 'Shape', 'Peak', 'Sustain', 'Vel', and 'Env Level' controls.
- Gate:** 'Standard Gate' section with 'Delay', 'A', 'H', 'D', 'S', 'R' parameters.
- Modulators:** 'Modulator 1' and 'Modulator 2' sections with 'Shape', 'Peak', 'Sustain', 'Vel', and 'Env Level' controls.
- Routing:** 'Voice' and 'Routing' sections with 'P1', 'P2', 'P3' parameters.

The Pigments VST interface displays engine and filter settings:

- ENGINE 1-2:** Two engine sections with 'TUNE', 'UNISON', 'FREQ MOD', 'PHASE MOD', 'PHASE DISTORTION', and 'WAVEFOLDING' controls.
- OUTPUT:** 'OUTPUT' section with 'Filter Mix', 'Volume', and 'WAVETABLE' controls.
- FILTER 1-2:** Two filter sections with 'Cutoff', 'Reso', and 'LP12' parameters.
- MODULATOR:** 'MODULATOR' section with 'Tune: Rel', 'Volume', and 'W Noise' controls.

FREQUENCY

octave / coarse

semitone / tune / transpose

cent / fine tune / detune

2 OSC EFFECT

hard sync

ring modulation

Frequency Modulation

Cross Modulation

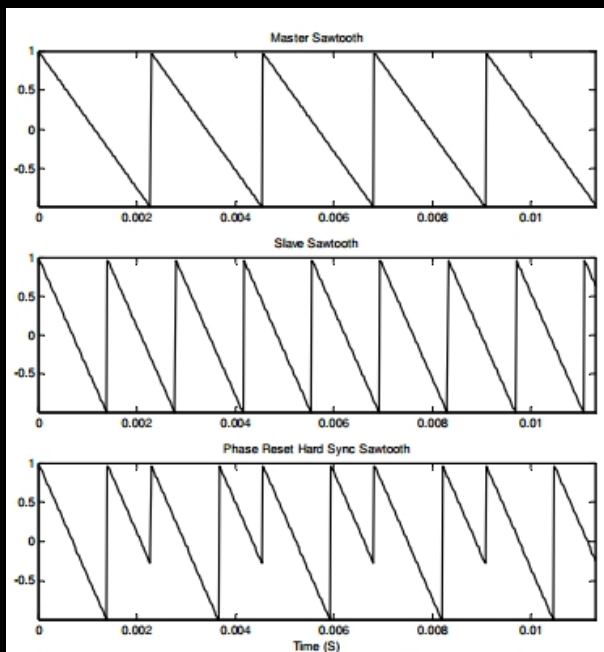

HARD SYNC

讓兩個音準不同的
OSC變成同一
個音準

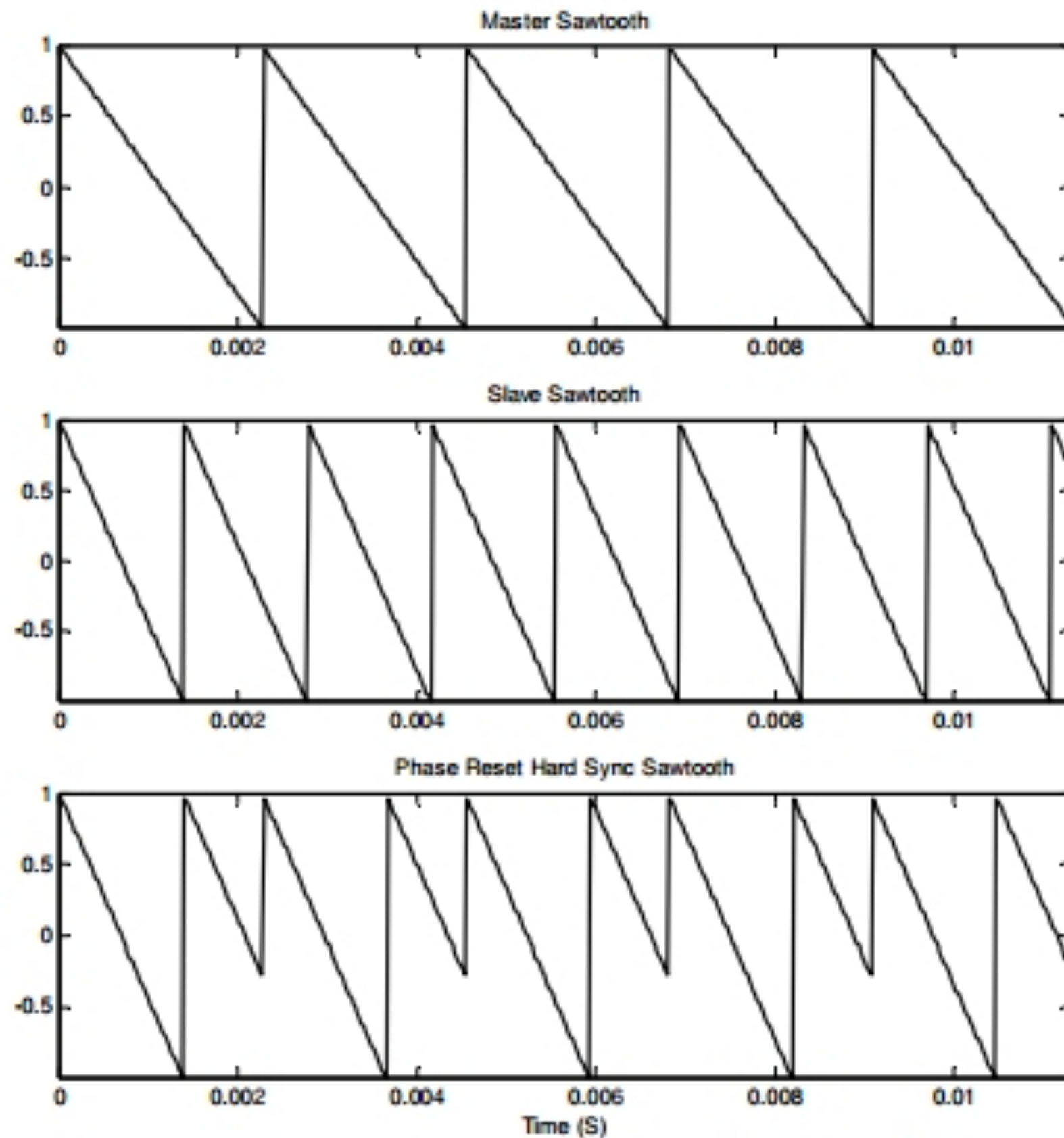

HARD SYNC

OSC 1



OSC 2

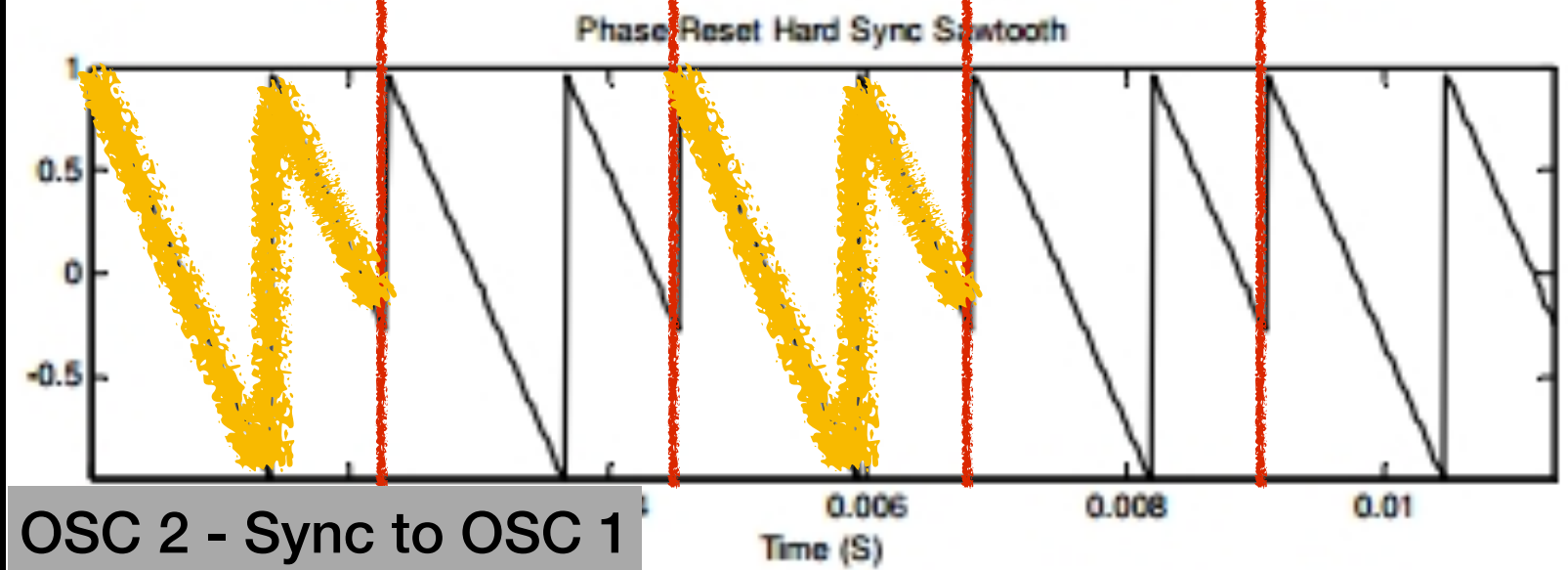

OSC 2 - Sync to OSC 1



HARD SYNC

hard sync 時，被 Sync 的 OSC 音高比 Sync Source OSC 高會比較能生出不同的波形。

如果比 Source 低一個八度以上就有可能無法發出聲音。

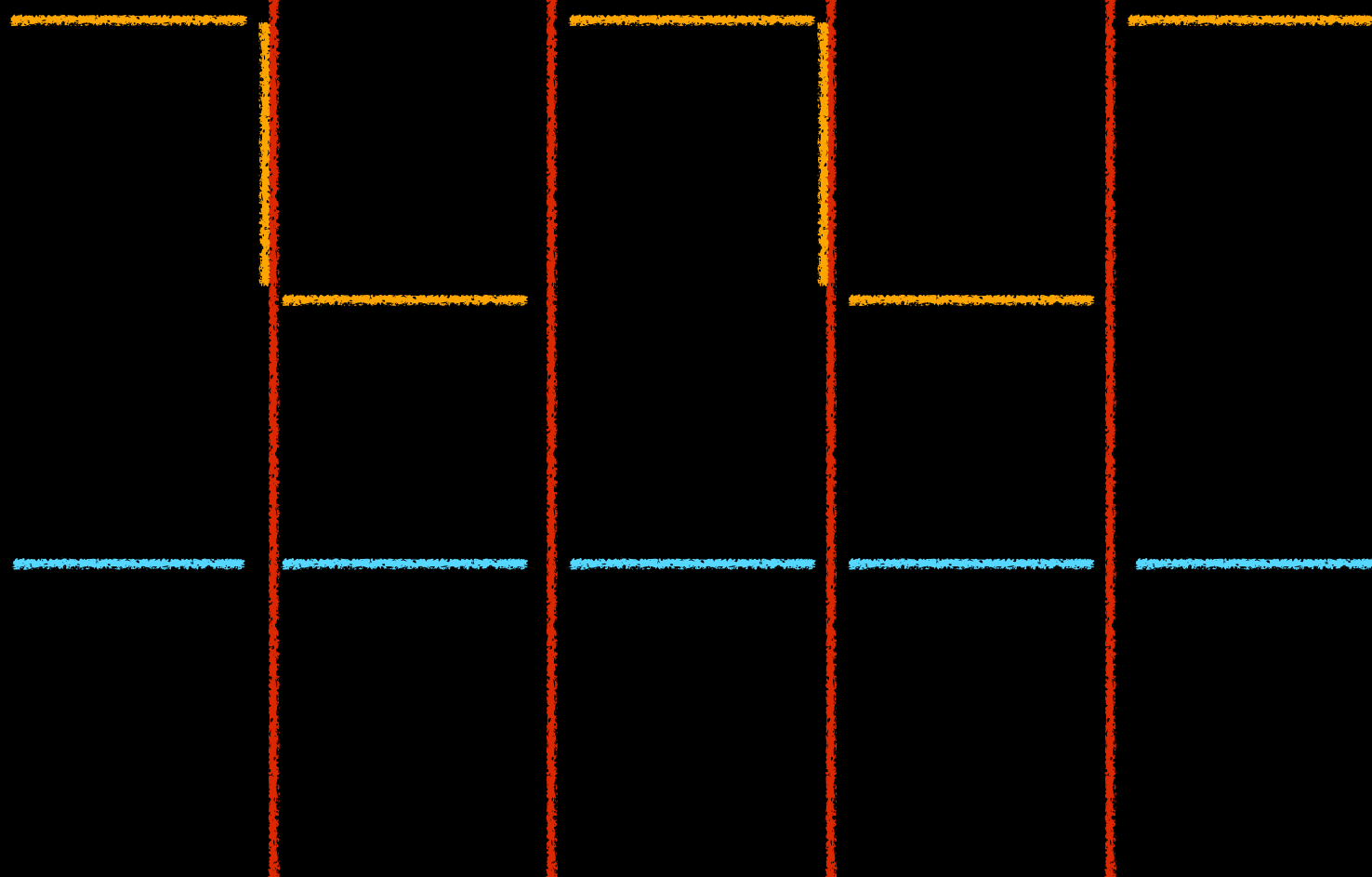
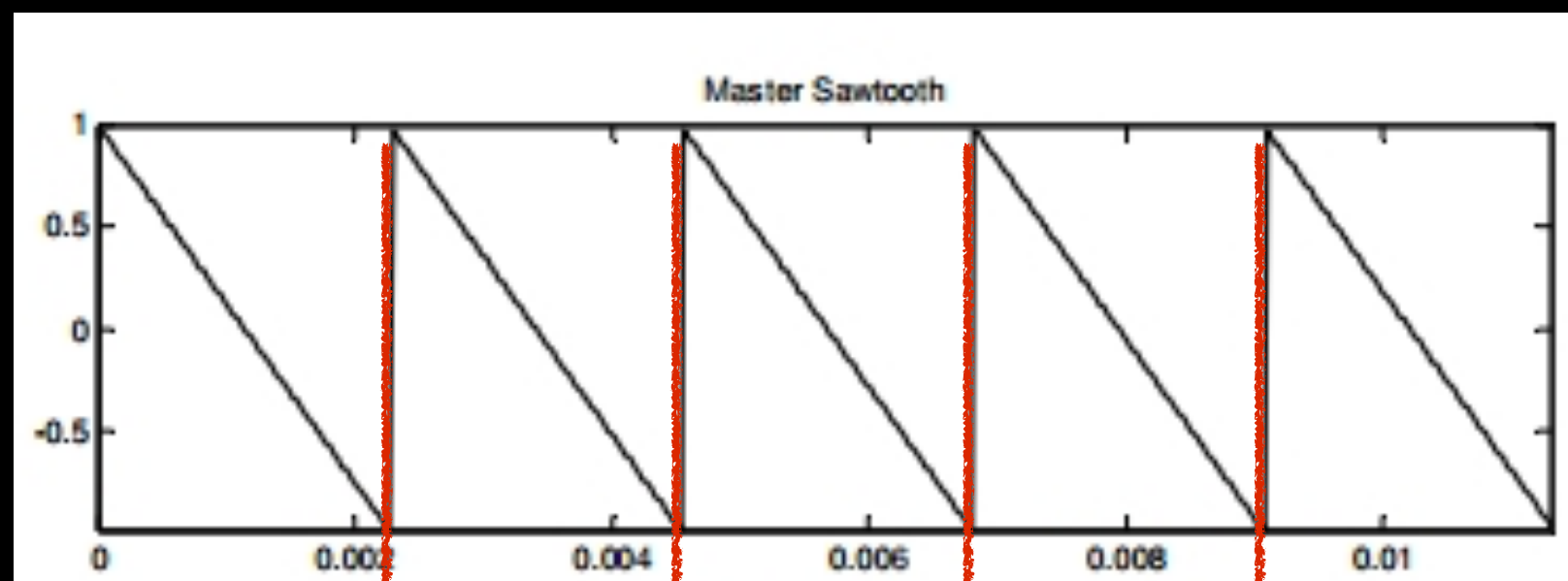

SOFT SYNC

Hard / Soft Sync :

Hard - 泛音絕對準確、喪失 Unison 產生的 Chorus 感。

Soft - 更多其他的對齊方式，產生的泛音不會像 Hard 一樣對死死。

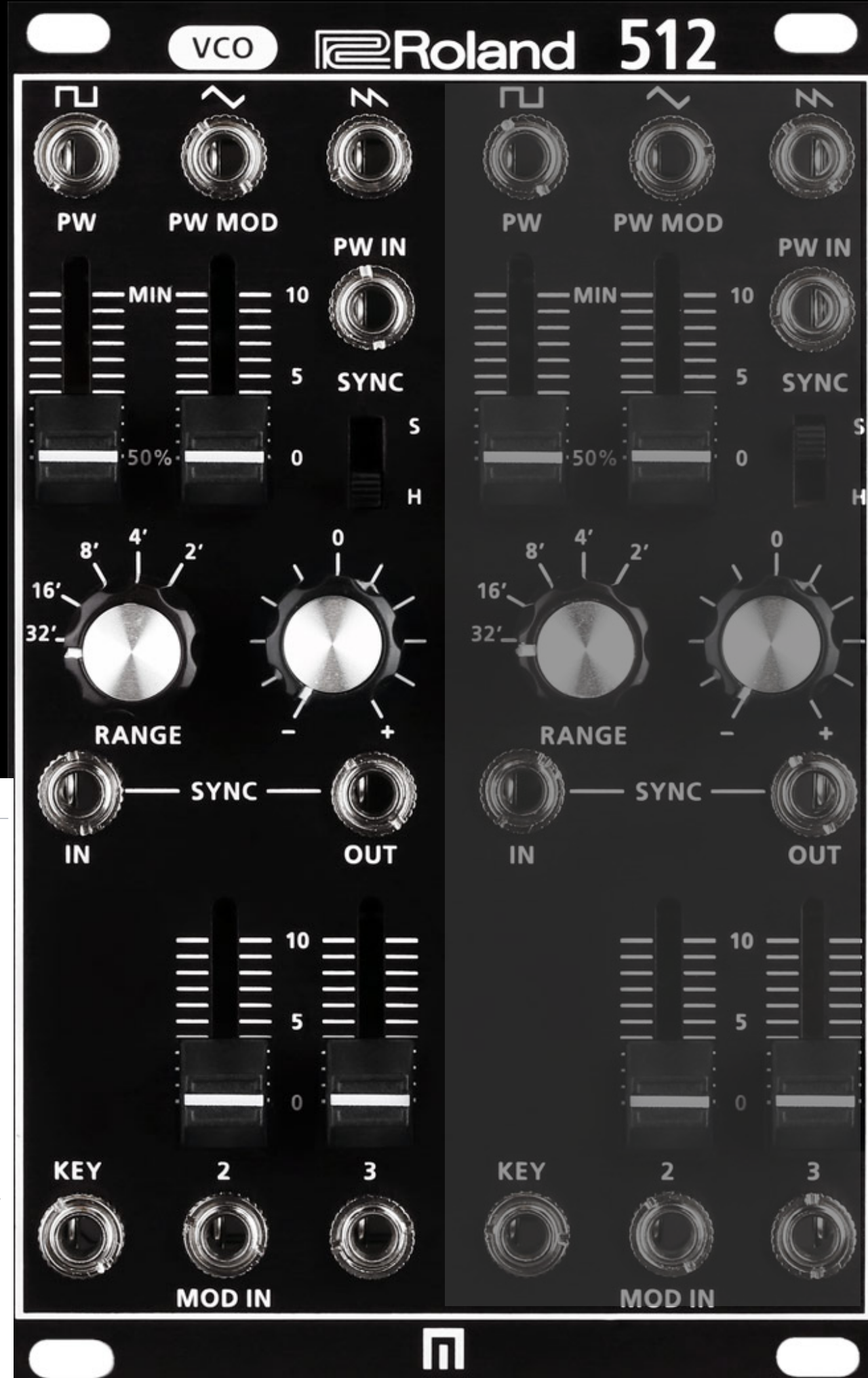

Soft Sync [edit]

There are several other kinds of sync which may also be called Soft Sync. In a Hard Sync setup, the slave oscillator is forced to reset to some level and phase (for example, zero) with every cycle of the master regardless of position or direction of the slave waveform, which often generates asymmetrical shapes.

In some cases,^{[3][4]} Soft Sync refers to a process intended to nudge and lock the slave oscillator into the same or an integer or fractional multiple of the master oscillator frequency when they both have similar phases, similar to a phase-locked loop.

Reversing Sync [edit]

This form of oscillator sync is less common. This form is very similar to Hard Sync, with one small difference. In Reversing Soft Sync, rather than resetting to zero, the wave is inverted; that is, its direction is reversed. Reversing Soft Sync is more associated with analog triangle core oscillators than analog sawtooth core oscillators.

Threshold or Weak Sync [edit]

Several kinds of Soft Sync use comparison thresholds:

- Hard Sync which is disabled when the frequency or amplitude of the slave crosses a user-defined threshold.
- Hard Sync which is disabled when the frequency of the slave extends too high above or too far below the frequency of the master.
- Hard Sync which is disabled when the frequency of the slave is lower than the frequency of the master.

Soft Sync may accurately refer to any of these, depending on the synthesizer or manufacturer in question.

Phase Advance 'Sync' [edit]

The phase of the slave is advanced by some amount when the master oscillator level crosses some threshold. Used for audio synthesis, this may give an audible effect similar to Soft Sync.

Reset Inhibit Sync [edit]

When the master oscillator crosses some threshold, the normal reset of the slave is disabled: it will stick at its final level, positive or negative. When the master crosses back over some threshold, the slave is reset.

Overlap Sync [edit]

In this method, the current wave completes but a new waveform is generated at the sync pulse. The tail of the old wave and the new wave are output summed if they overlap.

RING MODULATION

讓兩個音準不同的 OSC 變成更奇怪的音準

osc a 1000Hz

osc b 400Hz
Ring modulation

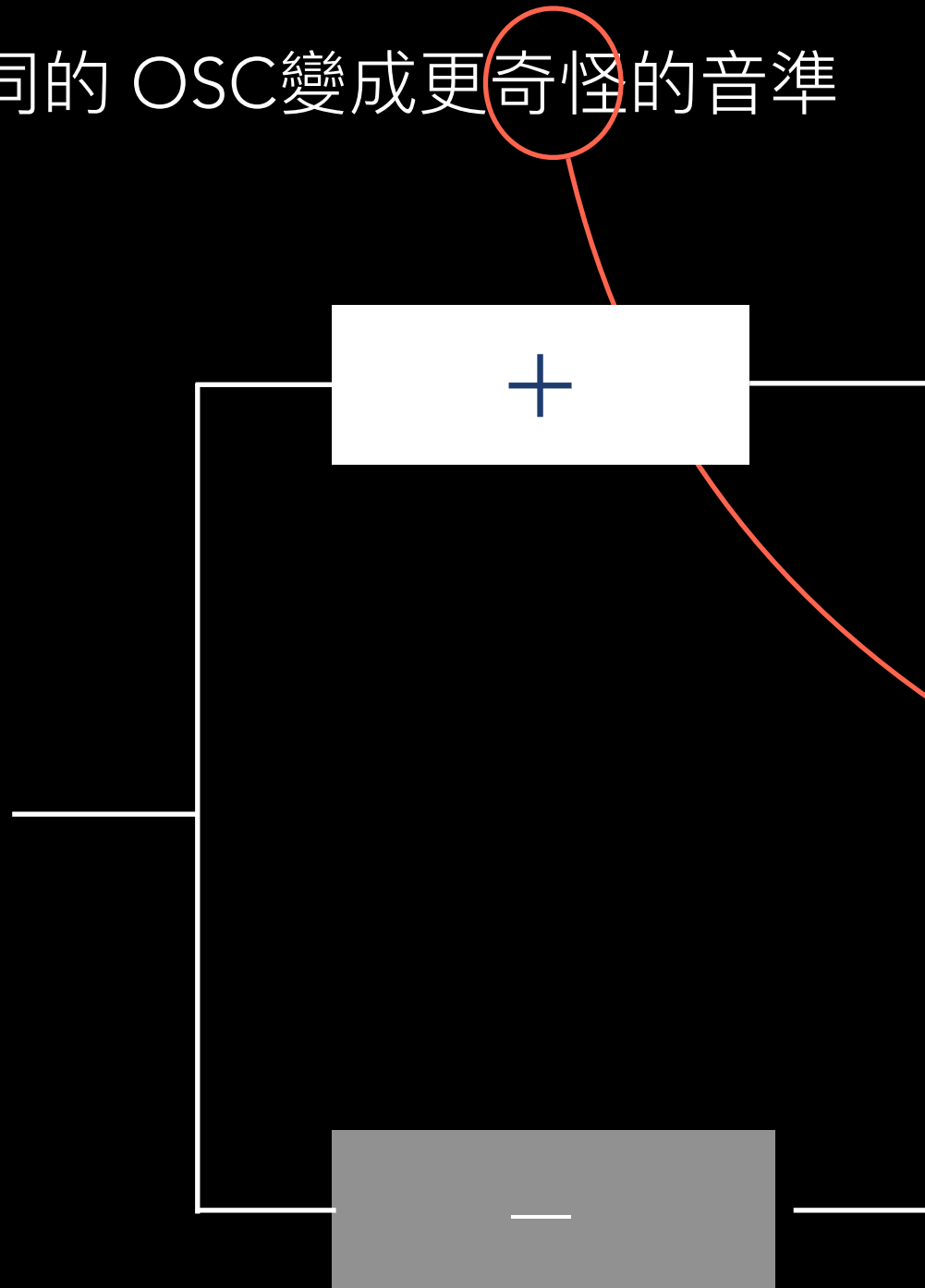

非整數倍泛音

1400Hz,
600Hz



編曲練習 (2)

用 Envelope 控制 Oscillator Pitch, 設計效果音或是大鼓
用不同 Oscillator Wave 設計泛音

Pitch Envelope

用 Envelope 控制 Oscillator Pitch,
設計效果音或是大鼓



Oscillator
Frequency

1. 使用 Sine wave
2. 用額外的 Envelope 控制 OSC Pitch
3. 調整 Decay 以及 Envelope / Modulation Amount 來修改音色



速度 230

先做 Kick

Pulse Width Bass*2

OSC Sync Lead 1

Super Saw Lead 2,
-10CT

Super Saw Pad + Reverb

Pink Noise mixing



FILTER

認識 Filter 模式、參數、效果、與知名的 Filter 型號

FILTER

- 泛音？

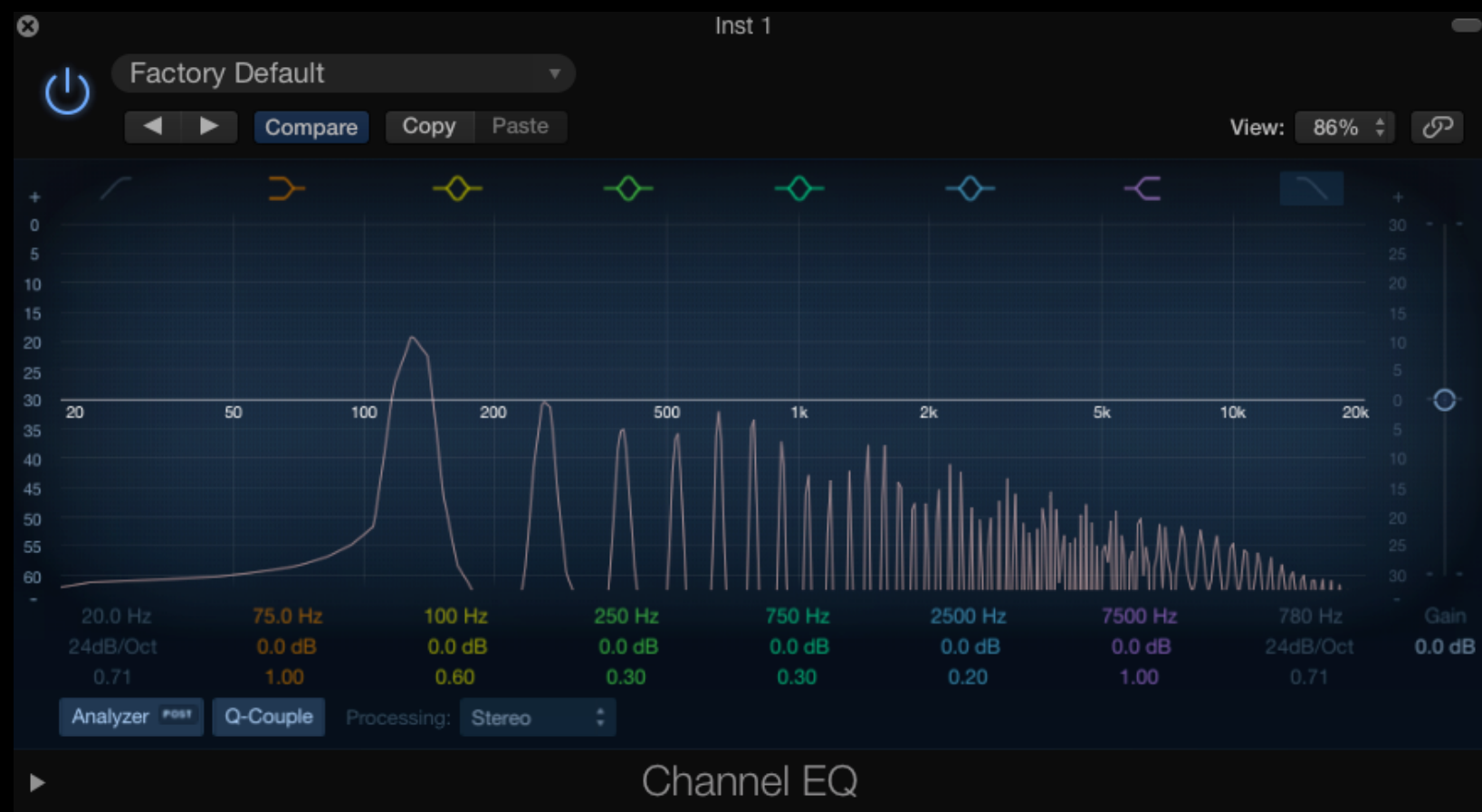

FILTER

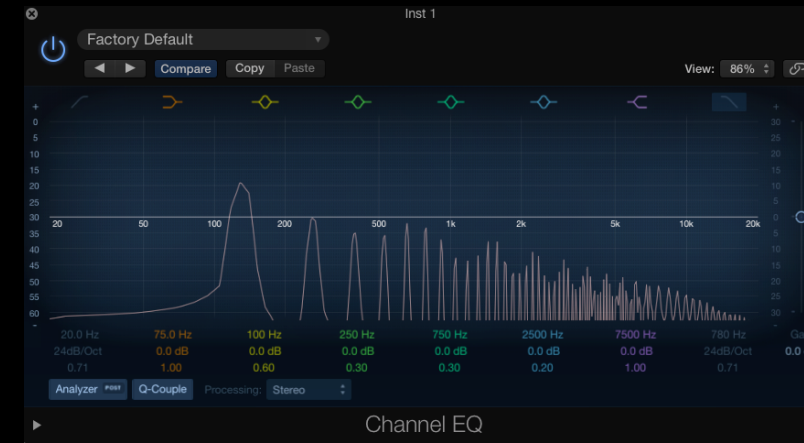

- 常見 Filter 模式



FILTER MODE

- Filter / VCF
- Low Pass Filter
- High Pass Filter
- Band Pass Filter
- Band Reject / Notch

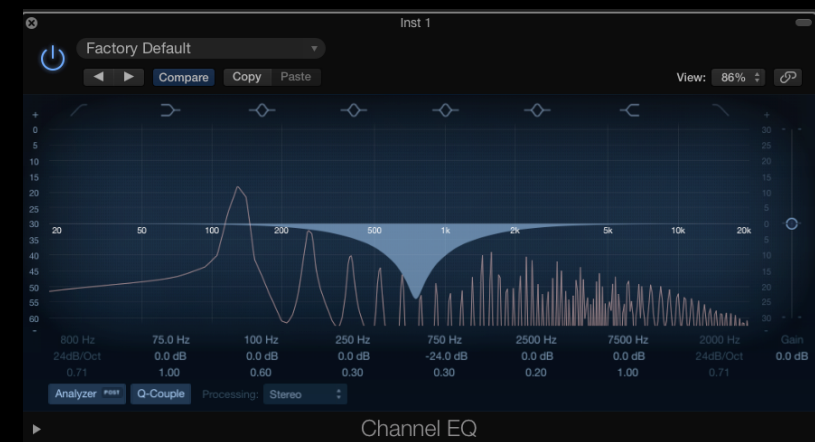
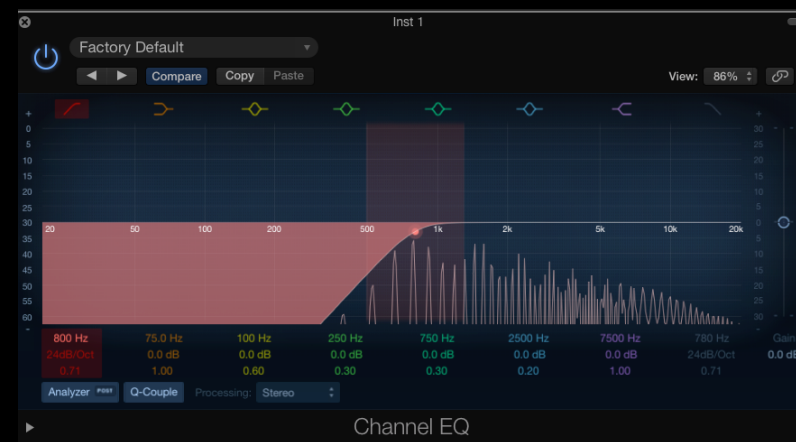
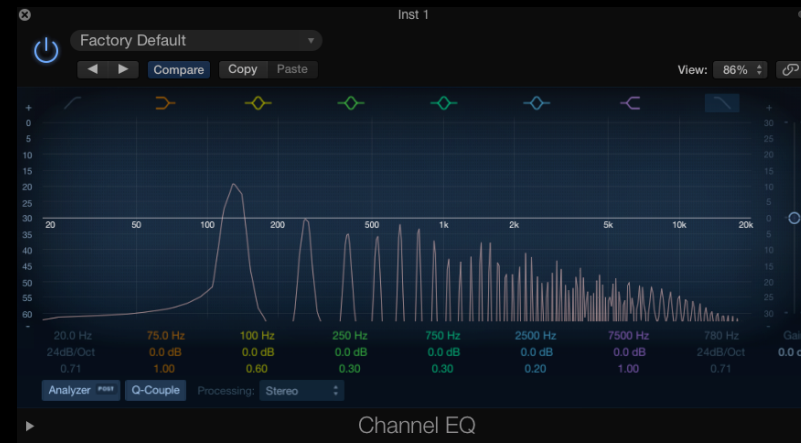

- Band Reject / Notch



LPF 與 HPF 的串聯與並聯



+



=

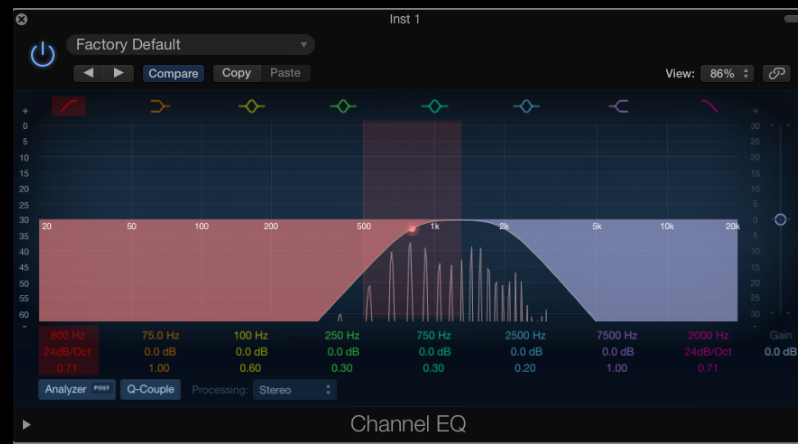

+

=

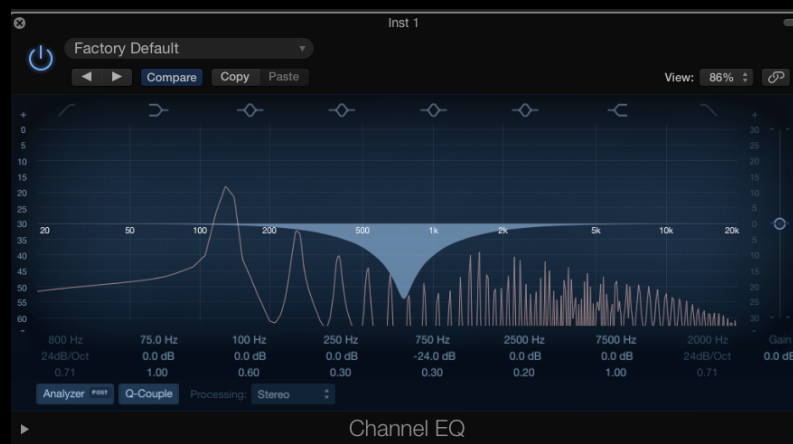

- Cutoff (Filter) Frequency
- Resonance / Emphasis



- 6, 12, 18, 24 dB/oct
- 1, 2, 3, 4 pole
- 1 pole = 6dB

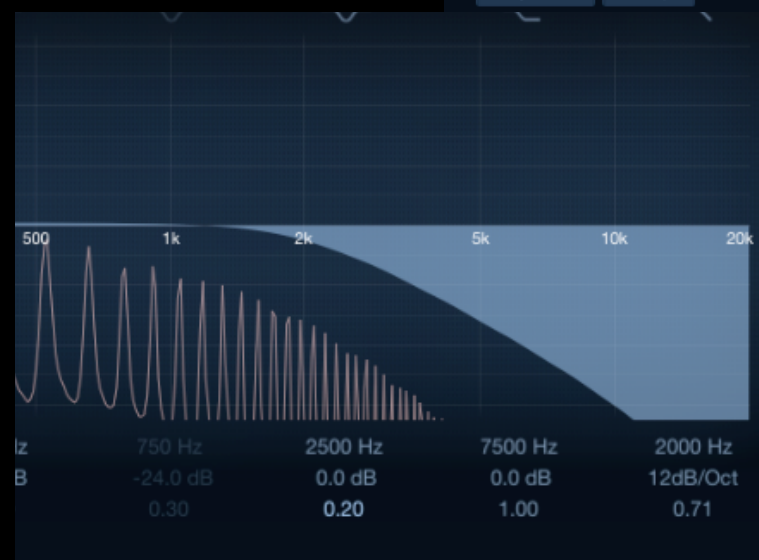
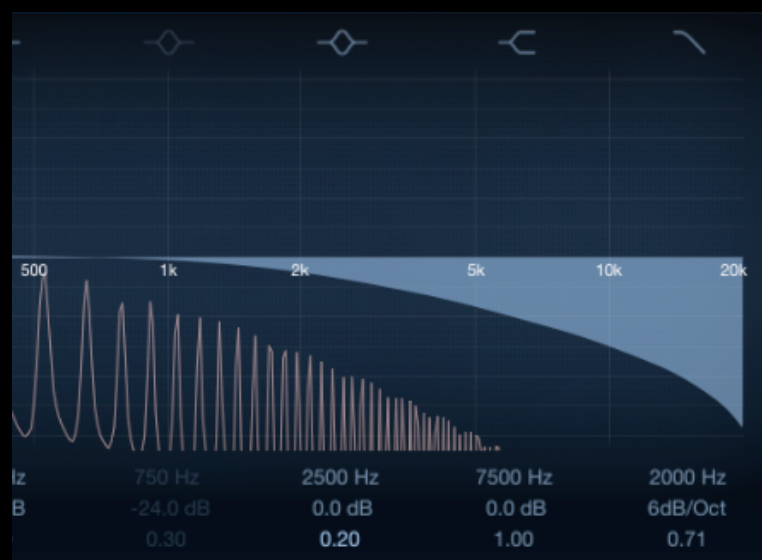
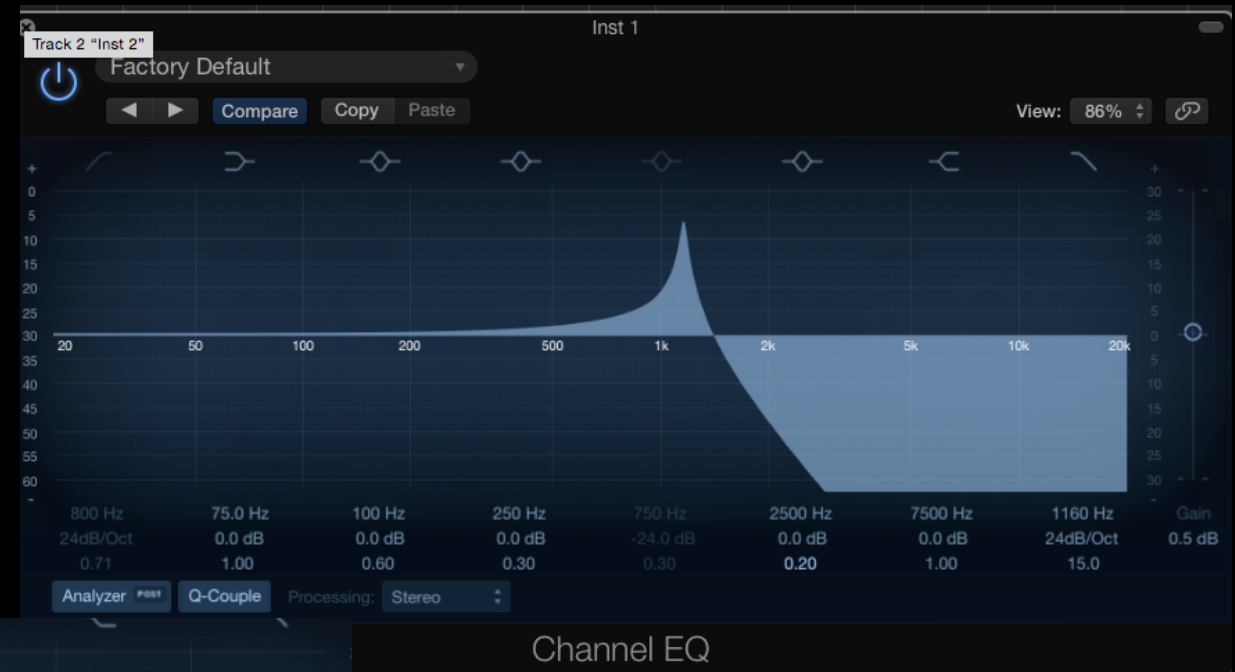

常見 FILTER

- Moog Ladder Filter

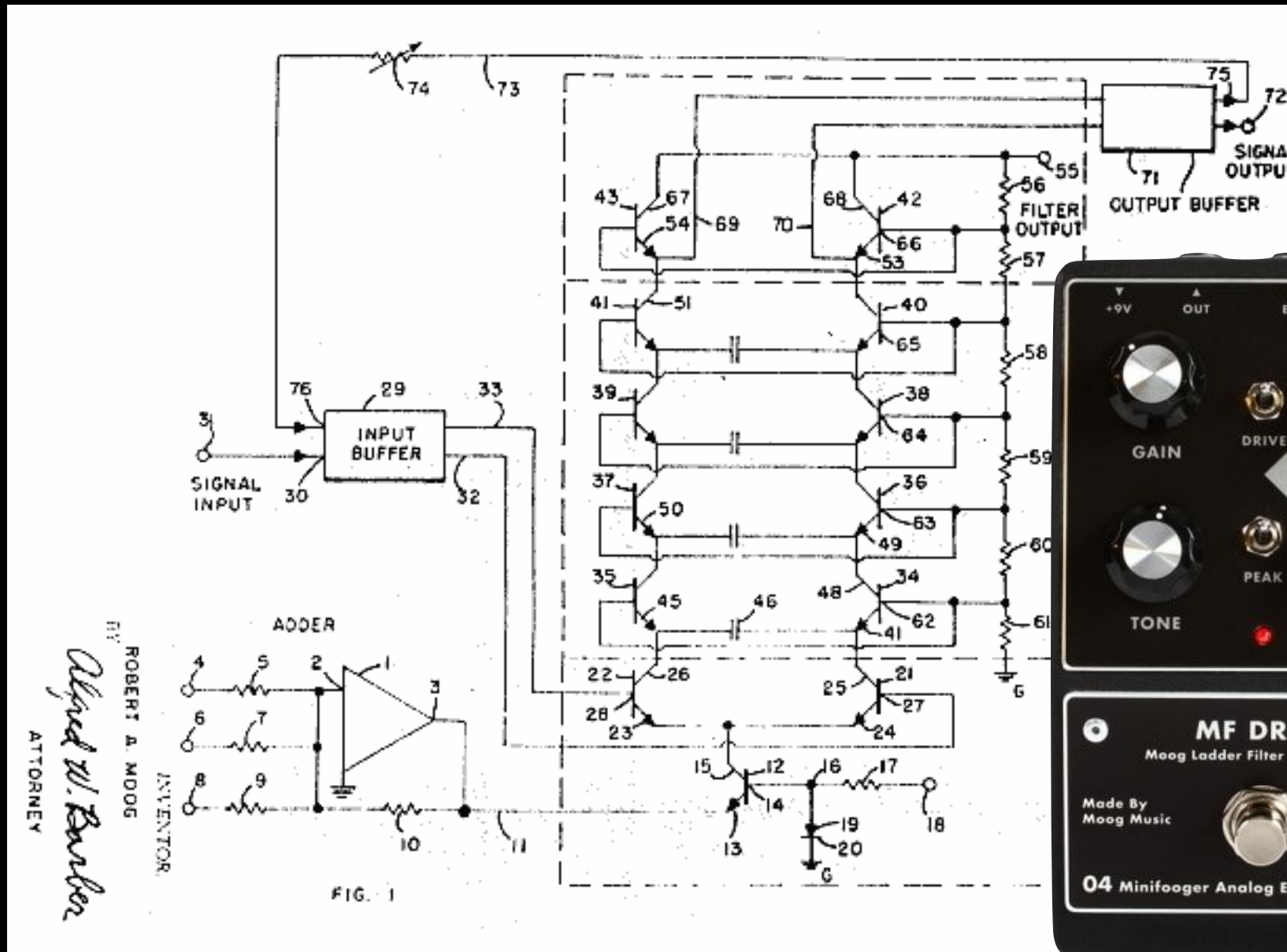

常見 FILTER

- Oberheim SEM State Variable Filter

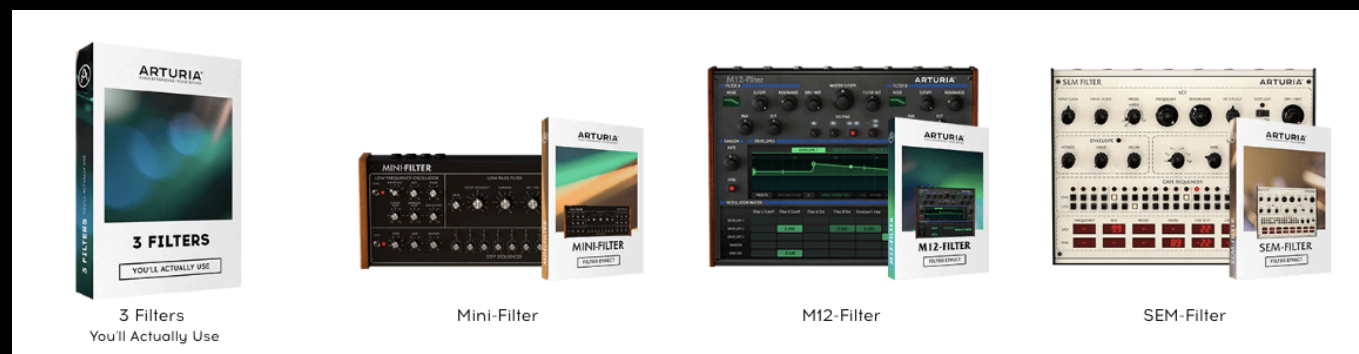
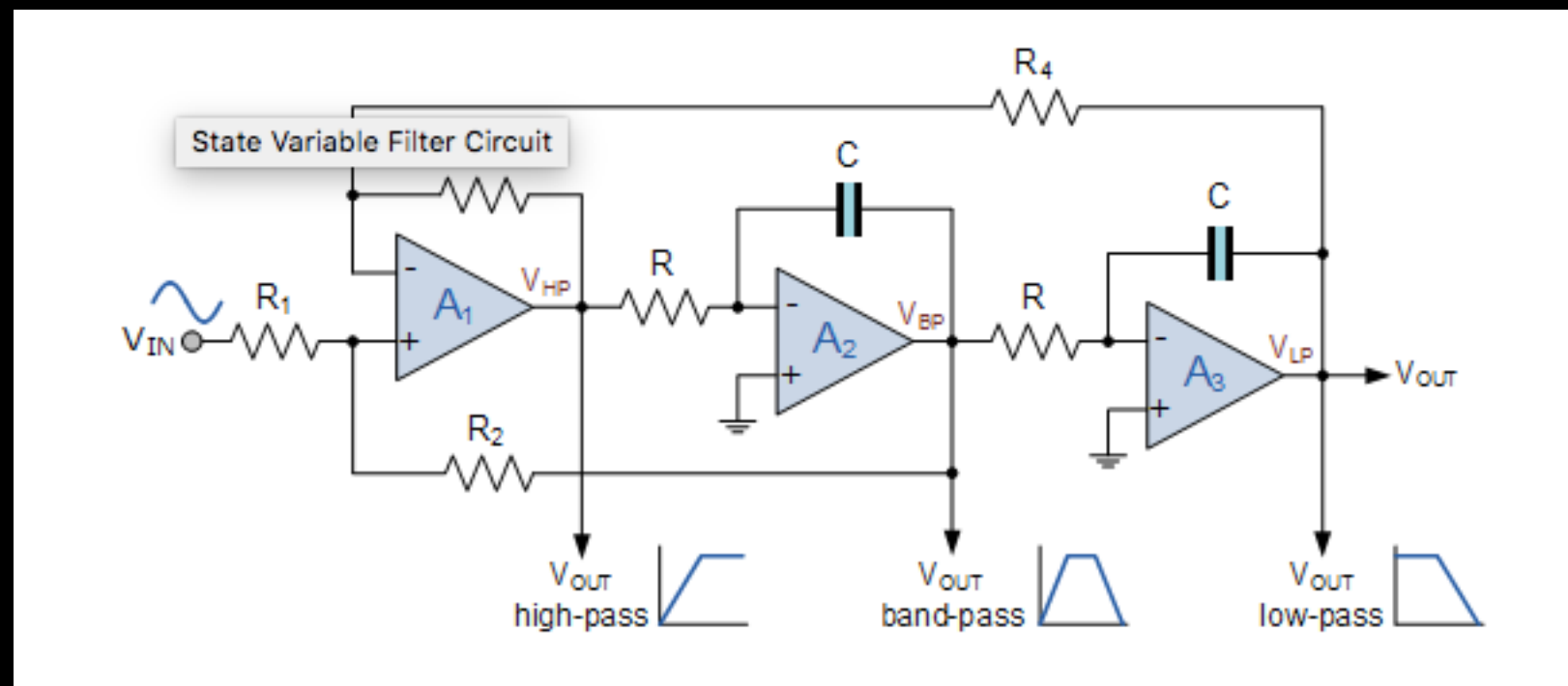

Filter Envelope

用 Envelope 控制 Filter Cutoff Frequency,
製造 Amp Env 無法做出的彈性



Filter Cutoff Frequency

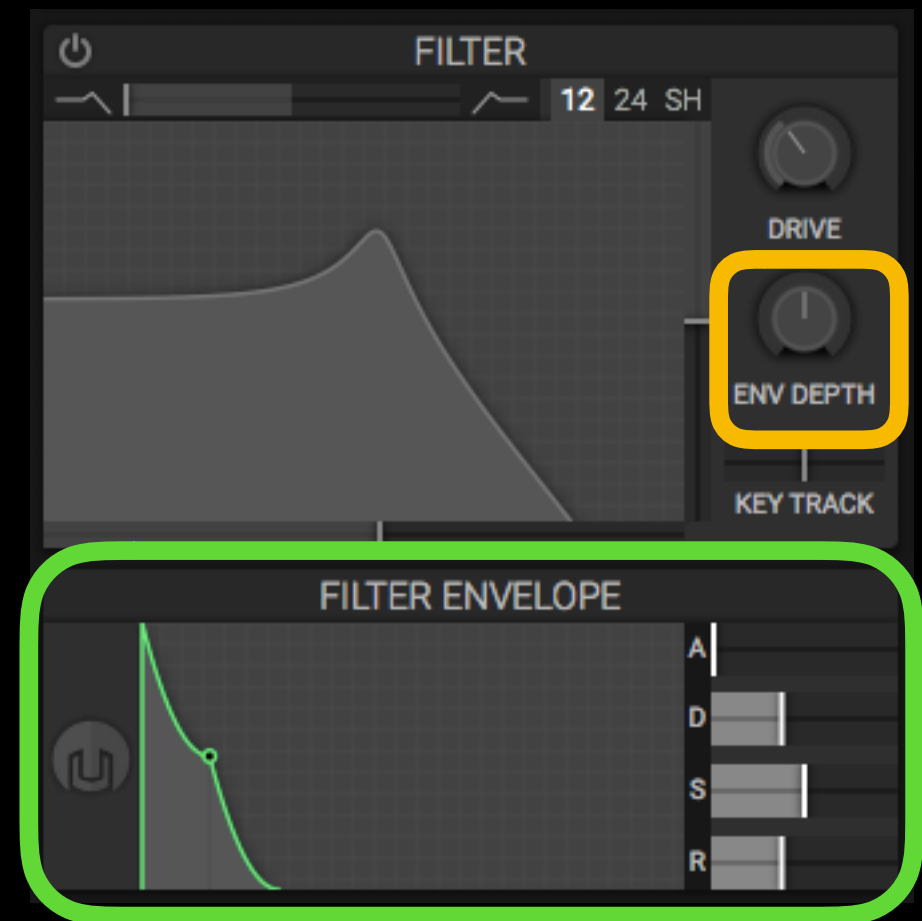

1. 使用 Sawtooth wave
2. 調整 Filter Env **Amount / Intensity / Depth / Contour**
3. 試著用先前 Amp Env 的編曲角色概念調整 Filter Env

FILTER ENVELOPE

START

END

REST

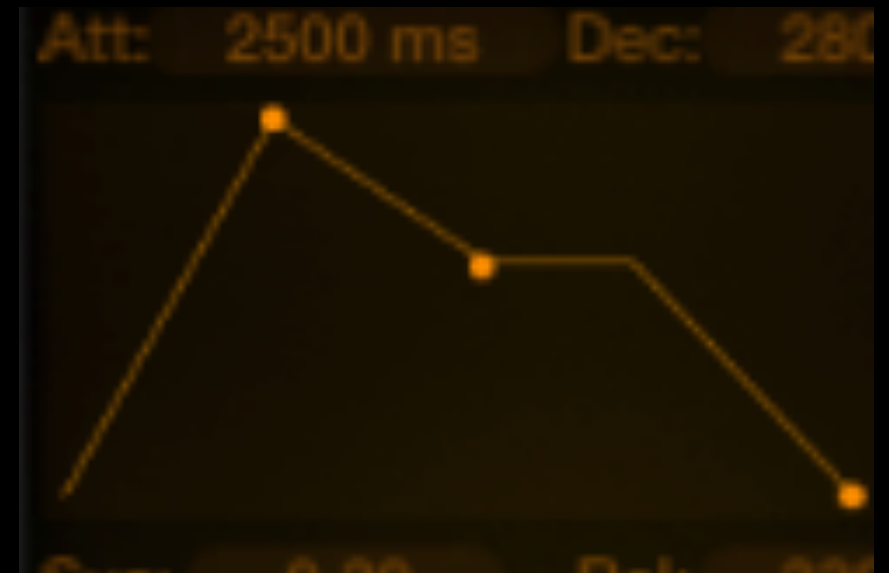

FILTER ENVELOPE

Attack
Time

Cutoff
Frequency

Modulation
Amt/Int/Depth/Contour

Release
Time

Sustain
Level

Decay
Time



MODULATION - SWEEP

- 在 Resonance 偏高的設定下，用 Envelope 控制 Cutoff Frequency



編曲練習 (3)

只用 Sawtooth wave 和 Filter 設計樂器的泛音分佈

更多 Filter 參數

Drive, FM, Key Tracking, Self Oscillation

FILTER DRIVE

- 利用 output feedback filter 做出 Drive
- Multidrive
- 有時會讓 Resonance 不明顯
- 有時候 Reso 強會讓 Drive 更明顯



FILTER FM

- Frequency Modulation
- 用 OSC1 去振動 (Modulate) Filter Cutoff
- 利用 OSC 比較高的頻率 / 速度，得到 Audible Rate Modulation



KEY TRACKING

- 用 Note 高度 Modulate Cutoff Frequency



SELF OSCILLATION

FILTERS

- 1 analog Curtis low-pass filter per voice, selectable 2- and 4-pole operation (self-resonating in 4-pole mode)

- Resonance 音量強到自體 Feedback 成為一個 Osc, 發出的波形是 Sine

HIGH-PASS FILTER

- Two-pole, resonant, high-pass filter per voice
- Bi-polar filter envelope amount
- Velocity modulation of envelope amount
- Keyboard tracking: off, half, full

LOW-PASS FILTER

- Four-pole, resonant, low-pass filter per voice, inspired by the original Prophet 5 filter
- Filter can be driven into self-oscillation with the Resonance control
- Bi-polar filter envelope amount
- Velocity modulation of envelope amount
- Keyboard tracking: off, half, full

Sawtooth Wave

擁有大量泛音，適合作為 Filter 練習的起點

速度 142

MIDI 靠尾對齊

刪除1~20小節

先調好 Kick

再由 Bass - Arp2 - Arp1
- Lead - Chord 的順序
調整

在 Arp1-2 加上 Delay 效
果器，並將兩軌 Pan 極
左右

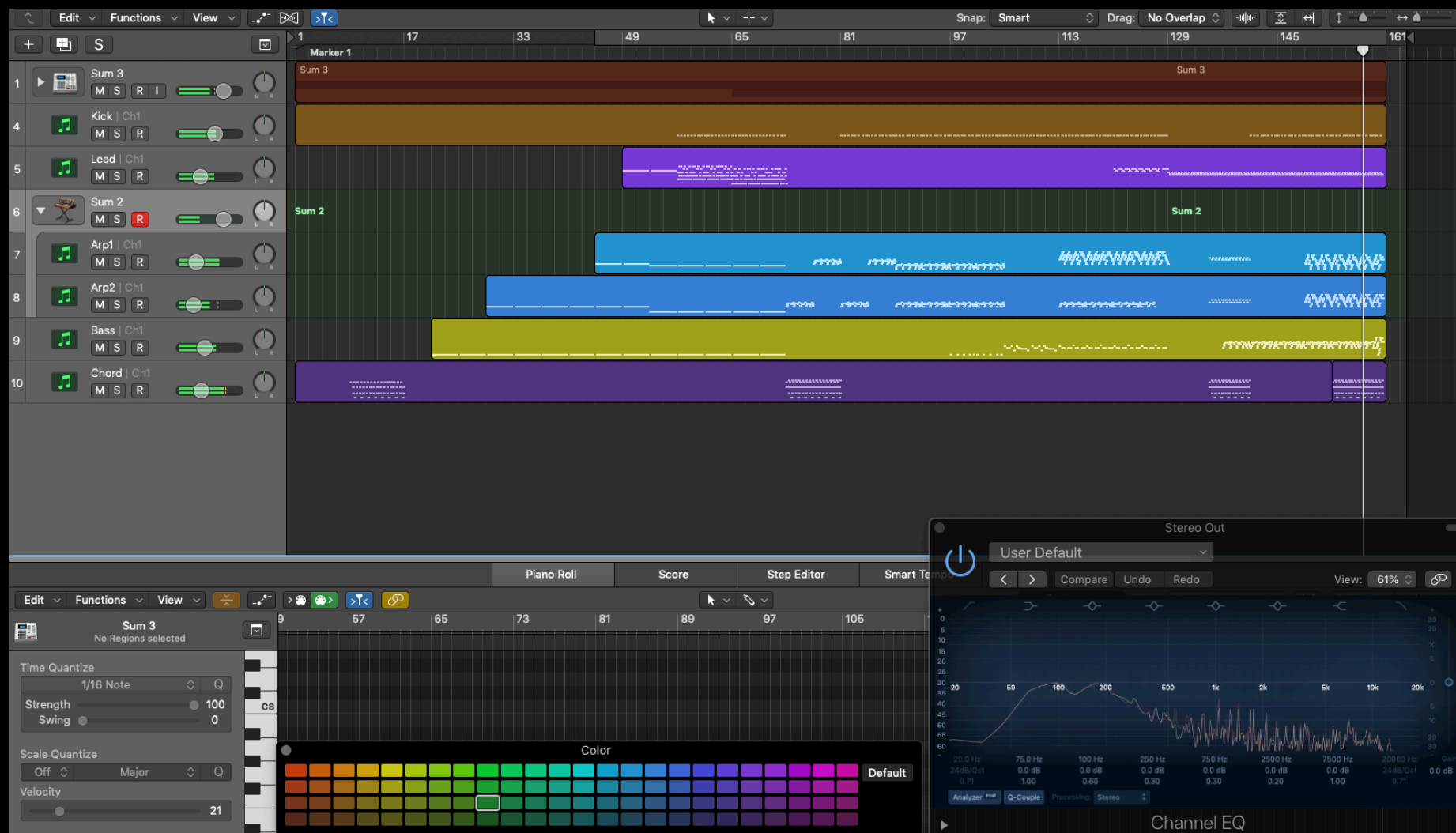

FILTER

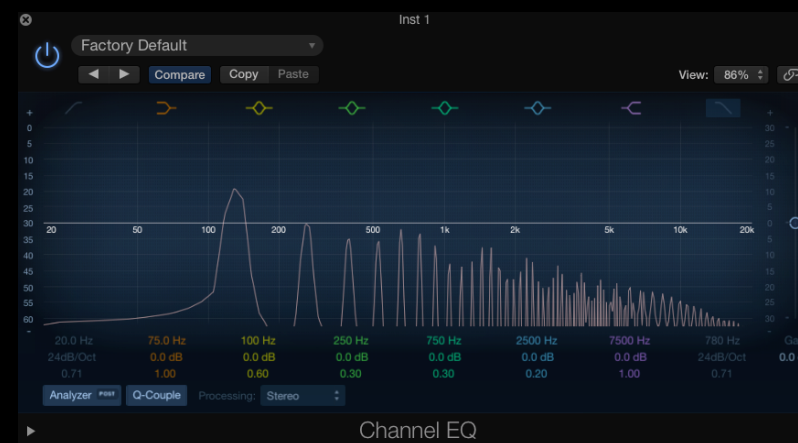

- 思考一下當下的樂器適合用哪一個 Filter 模式？



Send / Return

在編曲軟體的 Mixer 中利用 pre - fader send 的方式，獨立調整每一個 Track 進到 Reverb 效果器的音量。

在 Reverb 效果器中，利用 Low Cut (HPF) 與 High Cut (LPF) 調整最後要呈現的 Reverb 音色。

調整 Size 控制 Reverb 尾音長度。



Envelope

以 Envelope 為主軸的 Modulation



Envelope 是把一組 **Gate 訊號** 中的三個訊息，利用 **ADSR** 四個參數扳彎的一個機器。利用這個機制我們就可以把原本單純的 **Gate 訊號** 轉變成可以創造動態的 **Modulation Source**

以 ENVELOPE 作為 MODULATION SOURCE

Gate

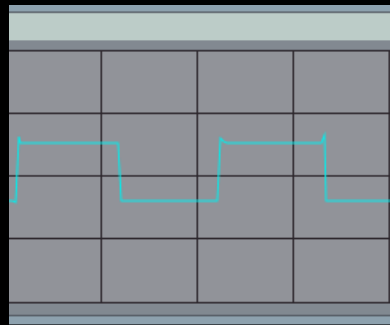

Envelope



Amount / Via Attenuator

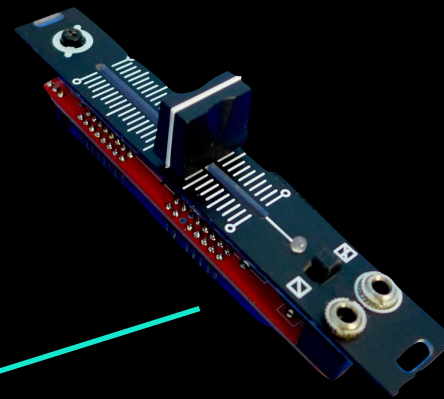

Target / Dest

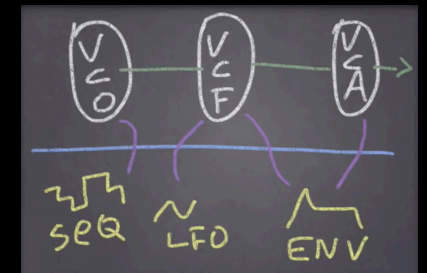

OSC

Pulse width, wavetable position
Morph : warp, fold,
Fm, sync, ring
mix, frequency

Filter

Mode, Cutoff, Reso, Drive

AMP / PAN





負方向的 Modulation - 當 Envelope Modulation Amount 設定成負的時候，可以想像成整個 Envelope 上下翻轉，此時 Sustain 的高度設定成 100% 時會到達最低點 (Mod Amt)。

以 ENVELOPE 作為 MODULATION SOURCE

Attack - Decay 短促的 Modulation

控制 Pulse Width

Attack - Decay 長的 Modulation

控制 OSC Pitch

AD為零、Sustain 全滿，

以 Release 為主、負方向的 Modulation

控制 Sync 後的 OSC Pitch

控制 OSC FM

控制 Ring Mod 以後的 OSC Pitch

控制 OSC Unison Voice Number

控制 Resonance

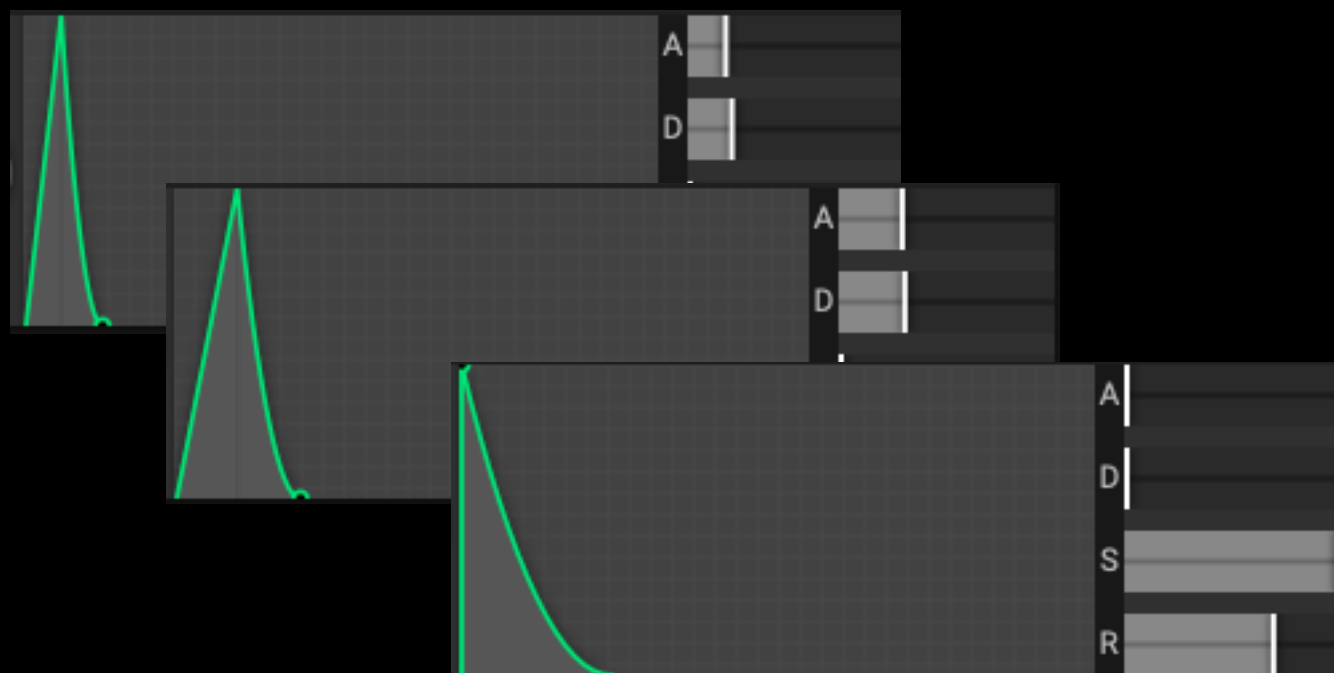

編曲練習 (4)

Modulation Envelope 與 Arpeggiator

Modulation Envelope

練習短、長、與 Release 的 Modulation Envelope



速度 86

先做 Kick

Bass - 短 Envelope

Chord 1 - 長 Envelope

Chord 2 - Release Mod

Modulation Envelope

練習短、長、與 Release 的 Modulation Envelope

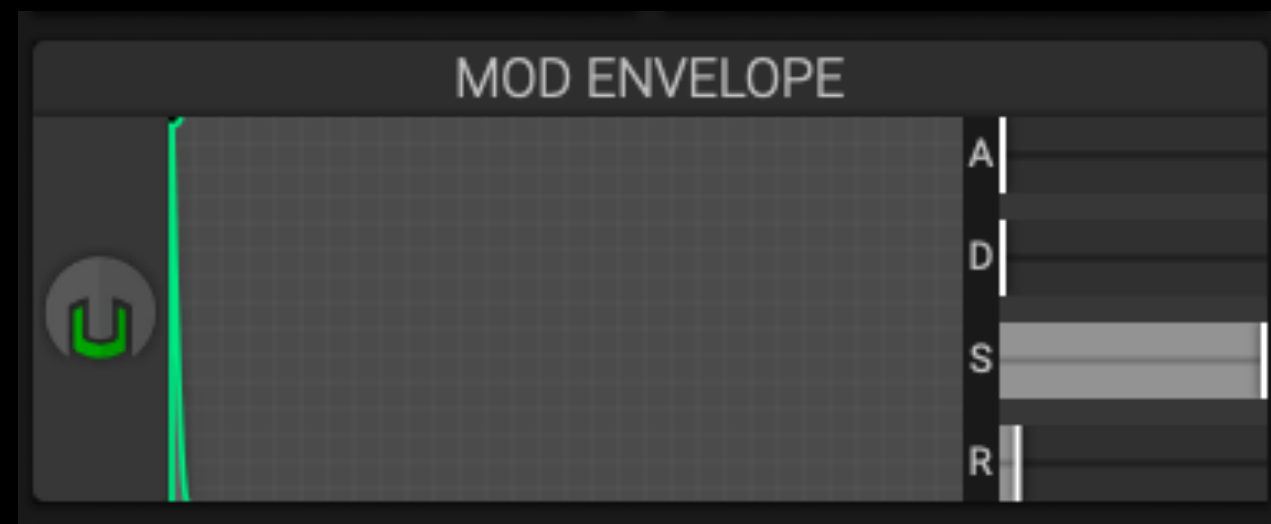

Arpeggiator

利用琶音器將 Chord 1 做成新的和弦 Pattern 與旋律



更多 Modulation Source

LFO、Sequencer

MADZINE

" OSCILLATOR "

WAVE SHAPE

FREQUENCY

LFO RANGE SELECTION

The Sub Phatty's LFO has three selectable ranges: 0.01 to 10Hz, 0.1 to 100Hz, and 1 to 1000 Hz. Although the mixer has no audio input for the LFO, an audio-frequency oscillator can be very useful as a modulation source, allowing the Sub Phatty to produce classic, clangerous FM (frequency modulation) tones.

LFO RATE

This control is used to determine the LFO's modulation frequency, which ranges from about 0.1Hz to approximately 350Hz. The LFO can reach up to 600Hz if an external control voltage is applied to the **LFO RATE** patch-point.



" FREQUENCY "

FREQUENCY > PITCH > RATE

HERTZ V.S. BPM

?HZ = 120BPM

" LOW FREQUENCY OSCILLATOR "

0.1 ~ 100HZ

Audible Range Modulation

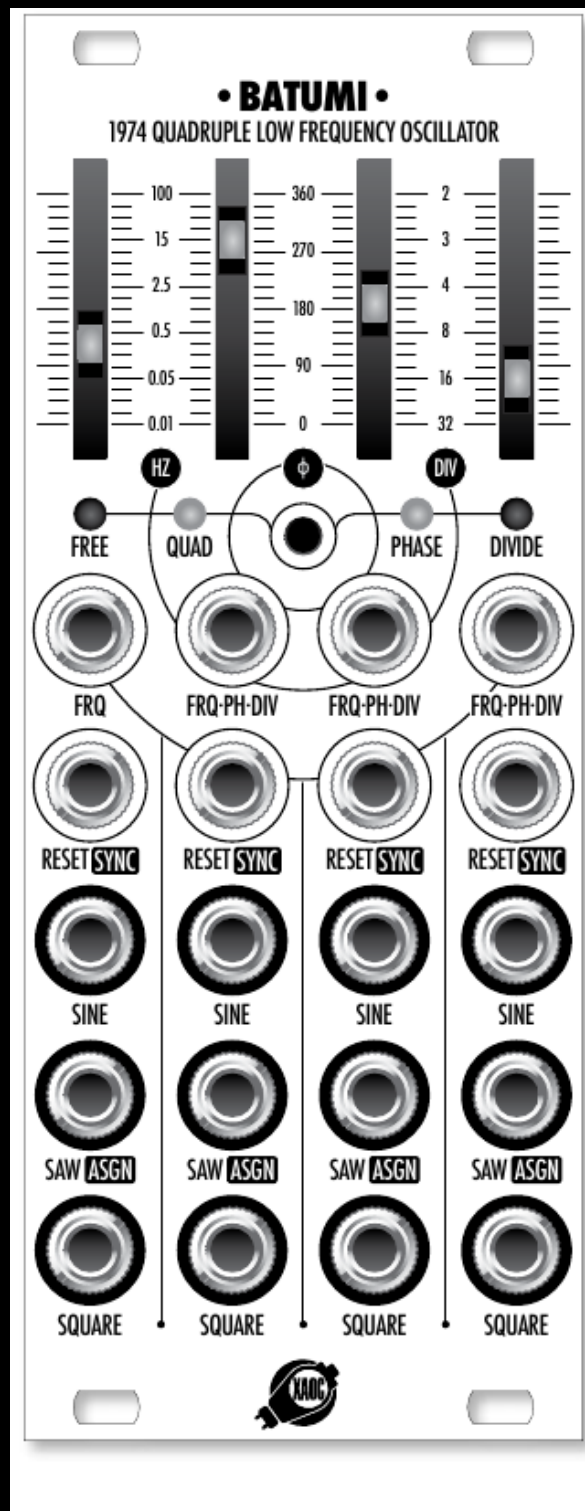

“ LOW FREQUENCY OSCILLATOR ”

MODULATION

$$A \gg B$$

Modulation Source : A

Modulation Target : B

Modulation Amount / Intensity

LFO AS MODULATION SOURCE

0. Always On (Tremolo, Vibrato, Auto-Pan, ...)
1. 取代 Envelope
2. 跨越 Gate 的限制，給 Pattern 更長的 Modulation

LFO RETRIGGER

polyphonic - retrigger

monophonic - retrigger

monophonic - none retrigger

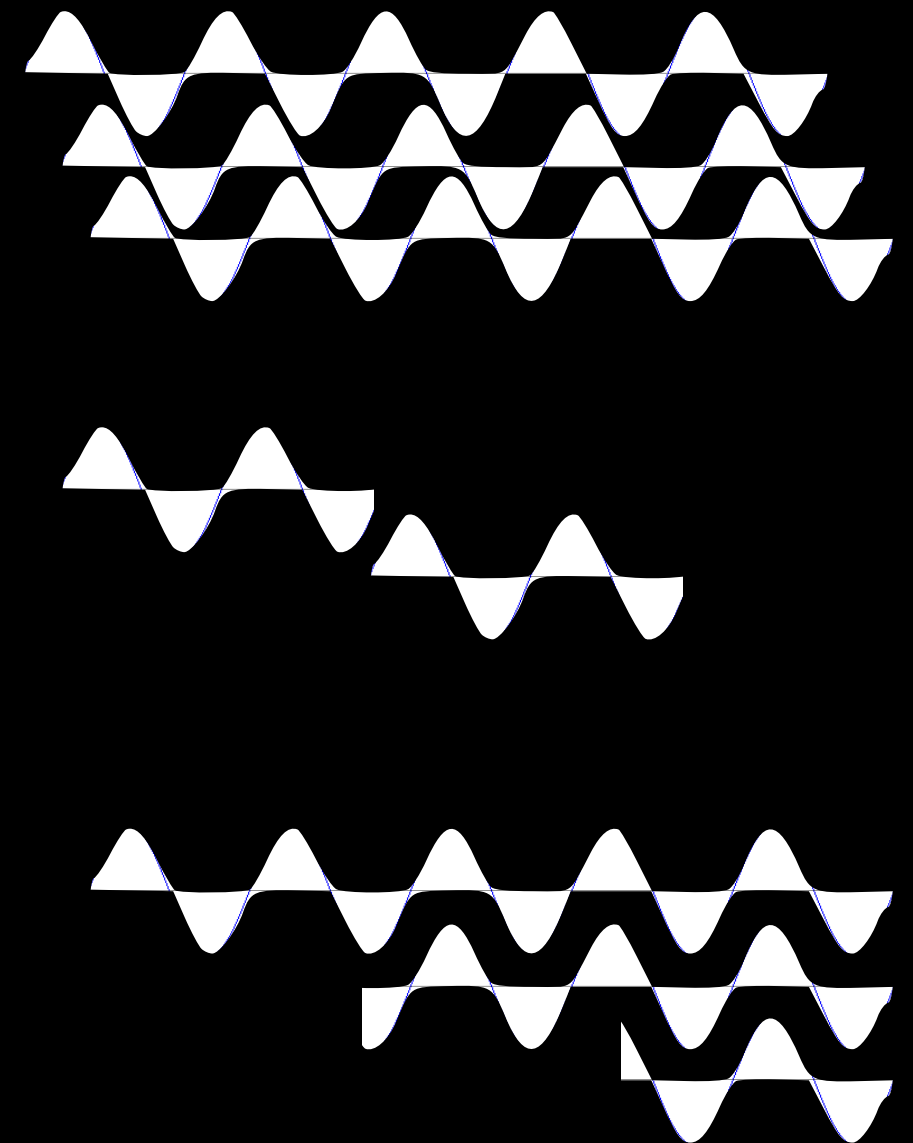

COMPLEX MODULATION

1. envelope -> filter cutoff

2. LFO -> filter cutoff

3. 輪流交替使用長短
Envelope / LFO

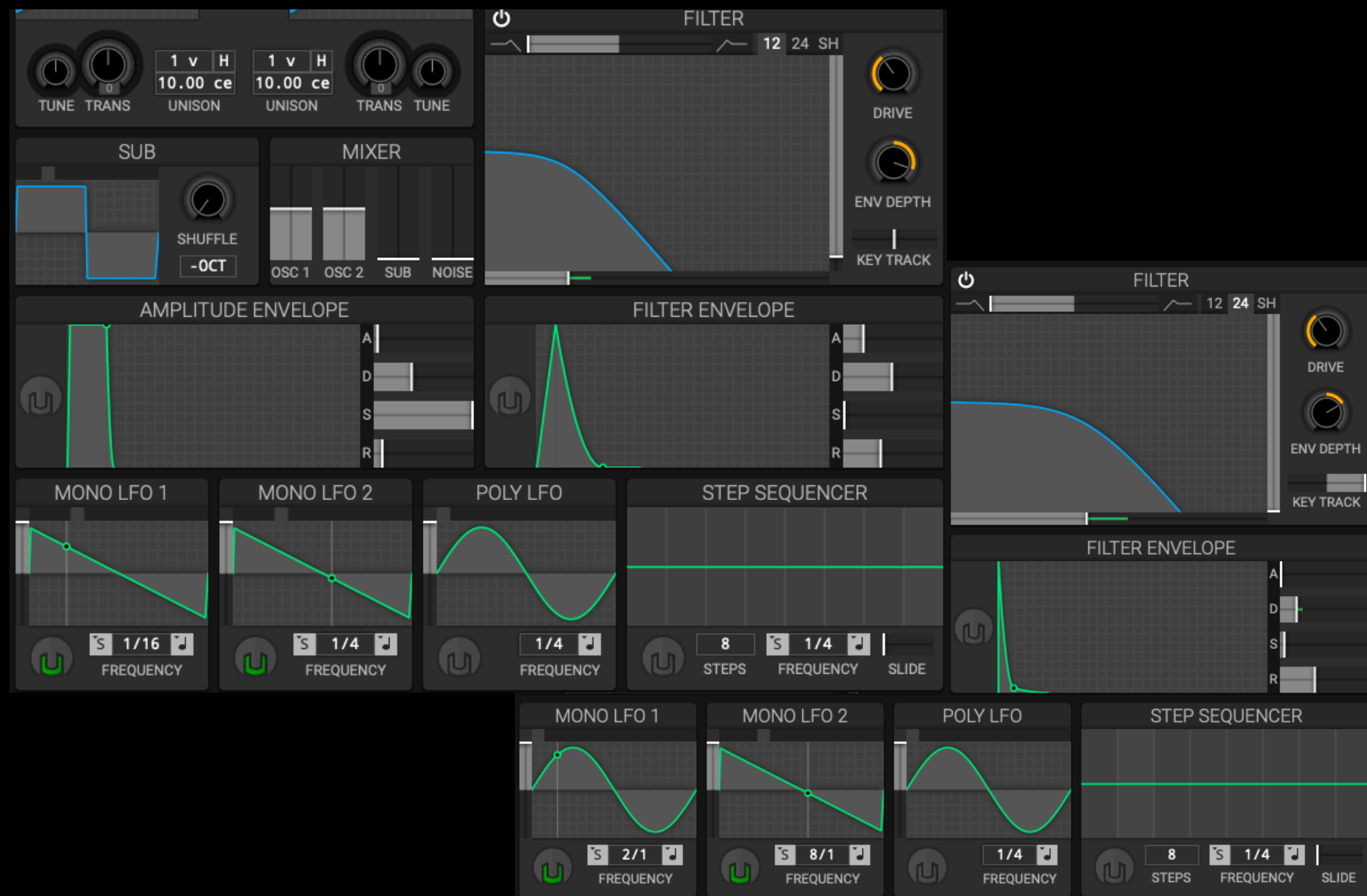

Sequencer

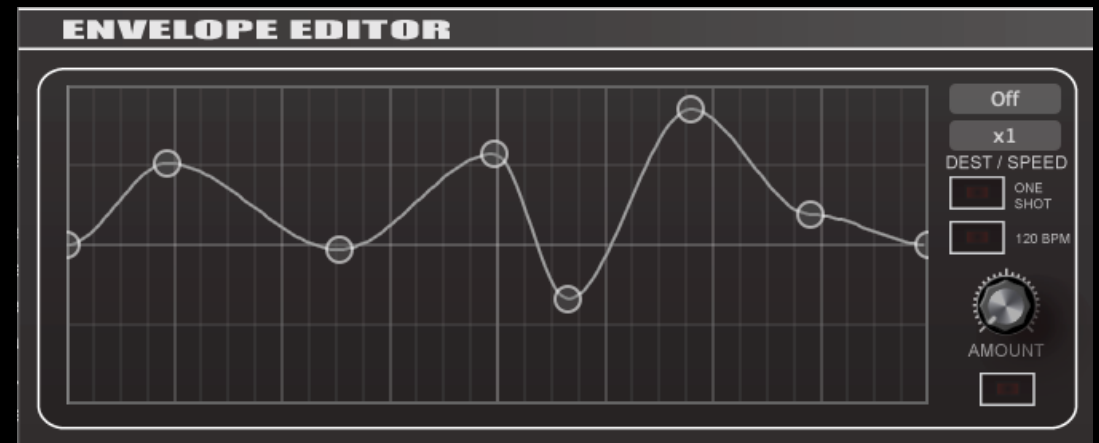
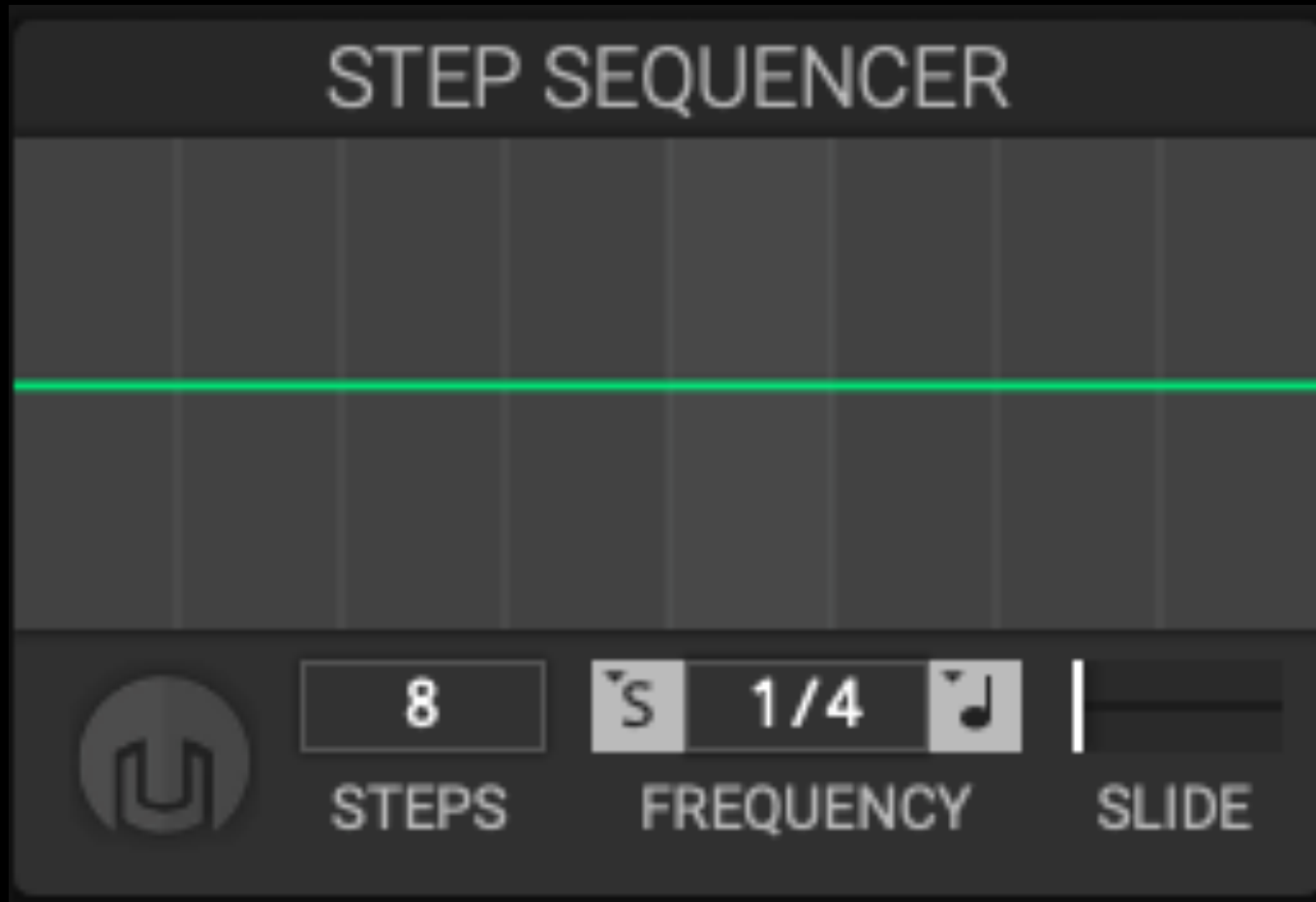

SEQUENCER AS MODULATION SOURCE

0. Always On (Tremolo, Vibrato, Auto-Pan, ...)
1. On / Off

編曲練習 (5)

利用 Performance Control 控制 Mod Amt.

Performance Control



Velocity 力度

音符 / 音高

PitchBend

Aftertouch

Modulation Wheel

Random 隨機

Vel	Note	PB	AT	Mod	Rand
50					
		2			
				100	

Performance Control

LFO



Target / Dest

Amount / Via

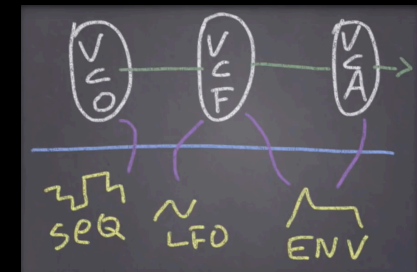

Velocity 力度 音符 / 音高

PitchBend

Aftertouch

Modulation Wheel

Random 隨機

Vel

Note

PB

AT

Mod

Rand

SOURCE	CURVE	AMOUNT	DESTINATION	TYPE	MOD	AUX SOURCE
LFO 1			B Semi	→	*	Mod Wheel

MODULATION

Target: Tune Coarse A

Smooth:

On LFO1 (Sine) E - Depth:

On

- Add Modulation
- Clear Modulation
- Copy Modulation
- Paste Modulation
- Edit Modulation

Target b/p: Pitch123

vis inv: ModWhl

Source: LFO2

Target b/p: Off

vis inv: Off

Source: Max



沿用編曲練習 (2)

將 Lead Sync 改為可以用 Modulation Wheel 控制的音色

將 Modulation Wheel 動態錄工作檔

保留其他音色



Frequency Modulation

FM 合成法

MADZINE

Operator 1



Audio Out

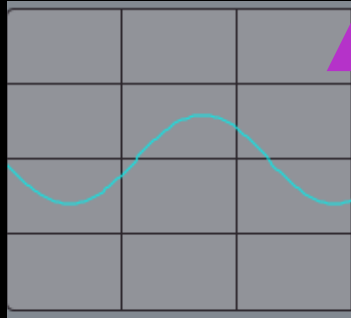

ENV 1



Operator 2

Coarse, Fine

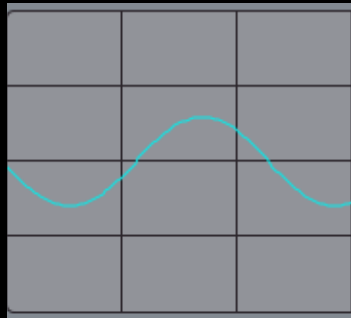

ENV 2



“ Algorithm ”

利用更多 Operator 改變排列方式得到更複雜的音色設計可能性。

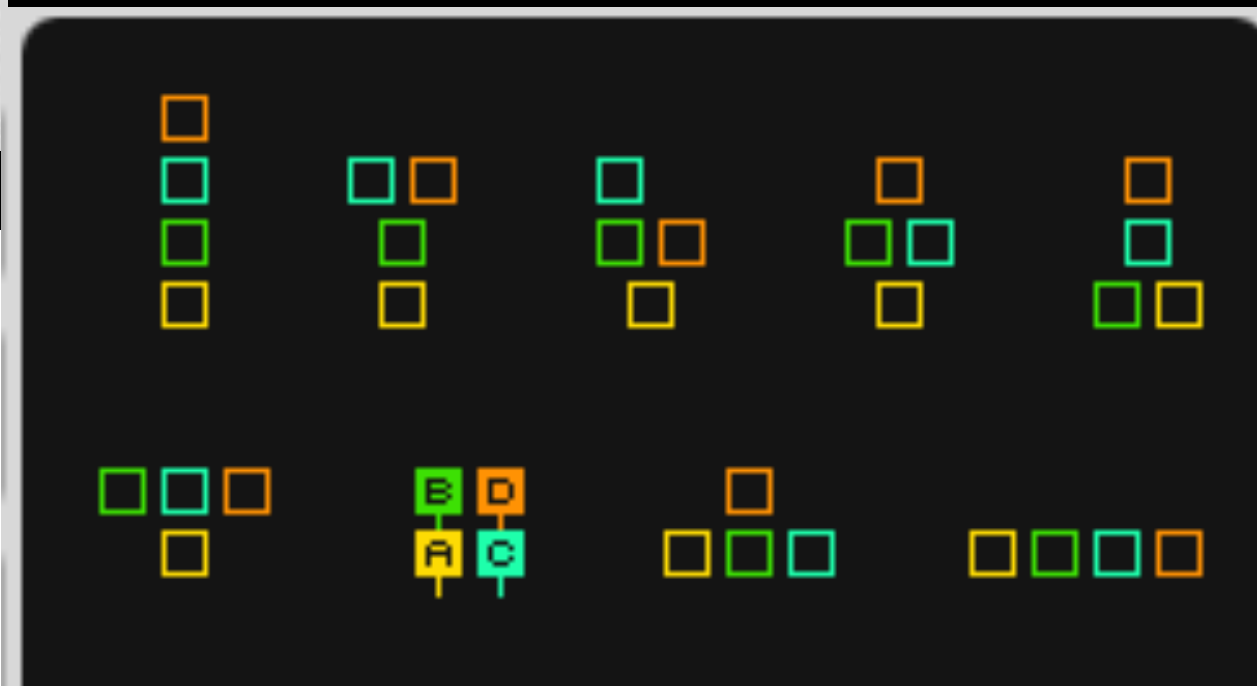
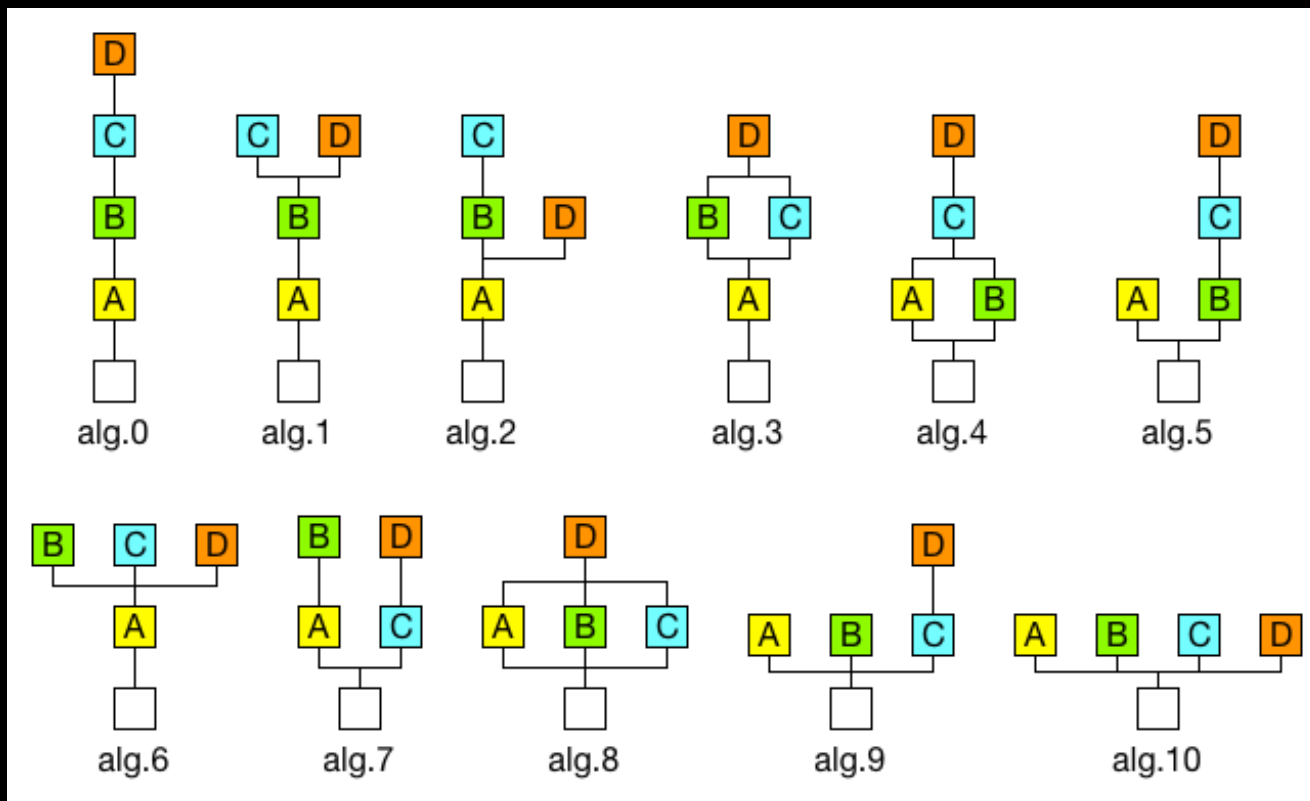
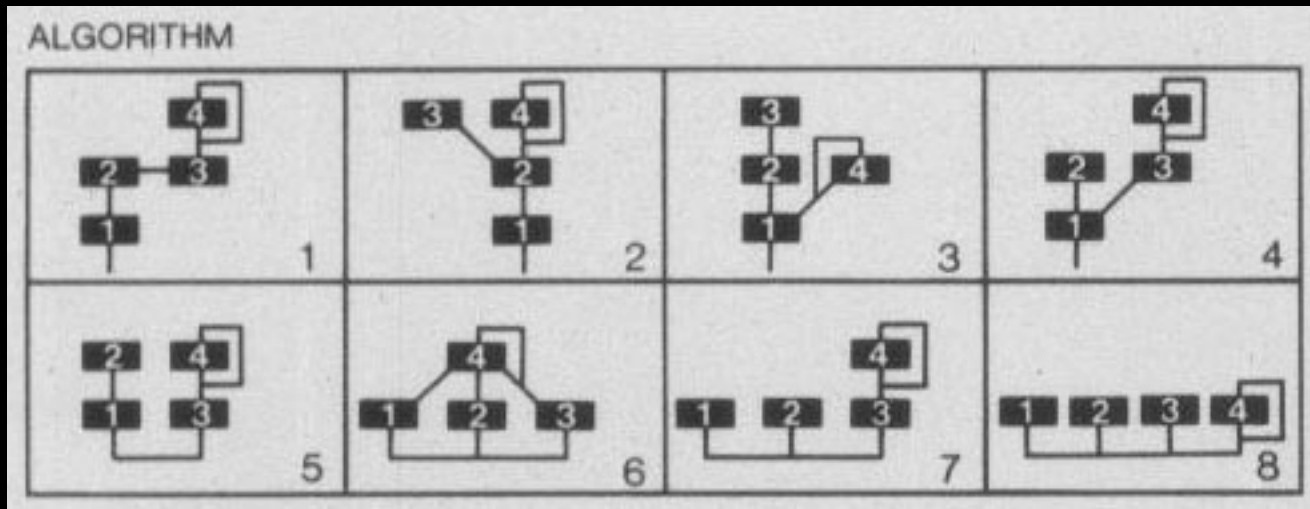

VCV Rack

v1.1.4

MADZINE

免費的桌面模組成成器

VCV Rack 是一套可以在電腦上運行的
模組成成器平台系統。

除了內建的基礎
模組外、還有各
式各樣包含聲音
與影像的模組，
大部分都可以免
費下載。

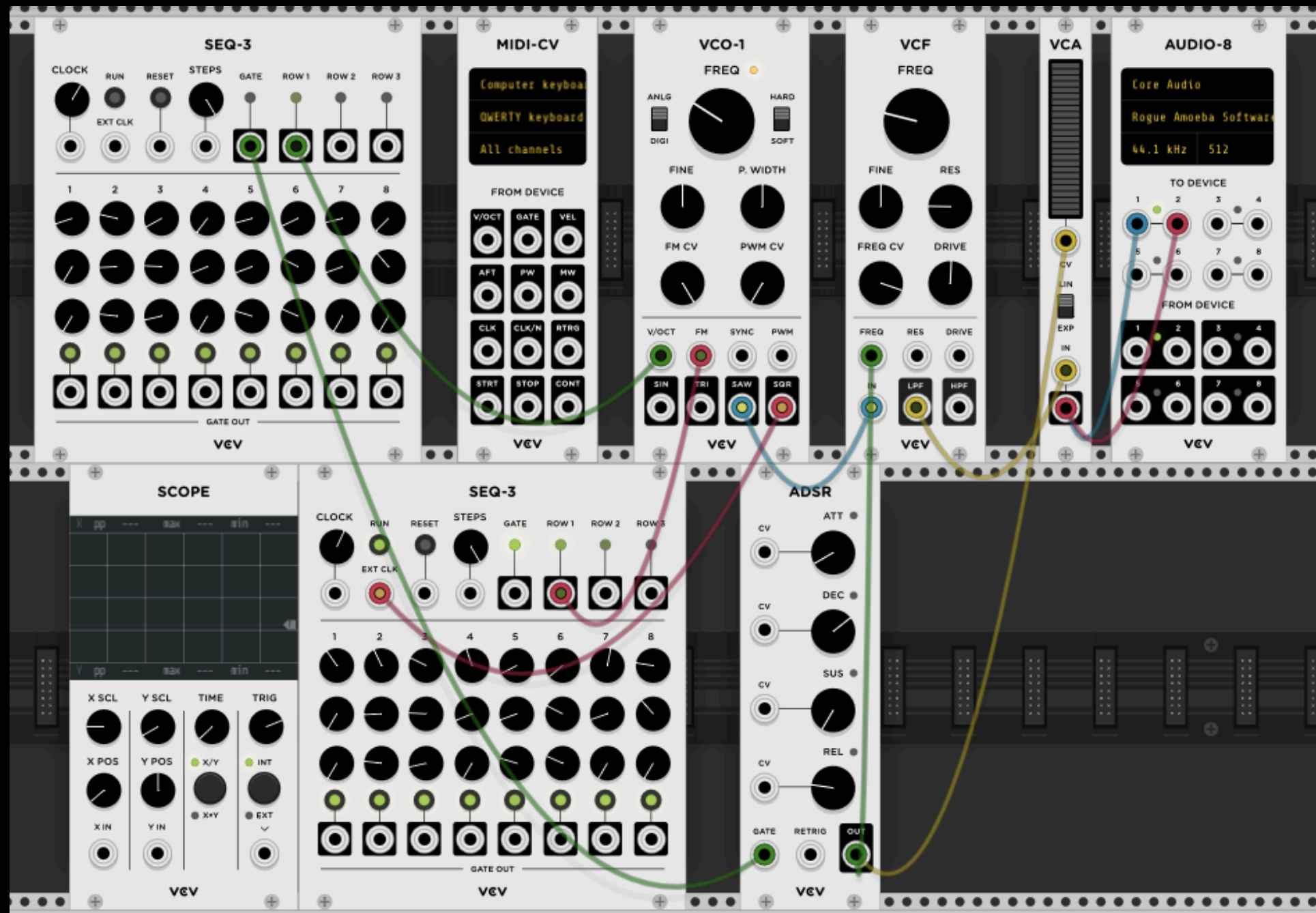

在 VCV Rack 裡面可以免費下載到模組
合成器名家 Mutable Instrument 的大量知名模組包含 Macro OSC, 物理建模、粒子合成器 Reverb 效果等產品。



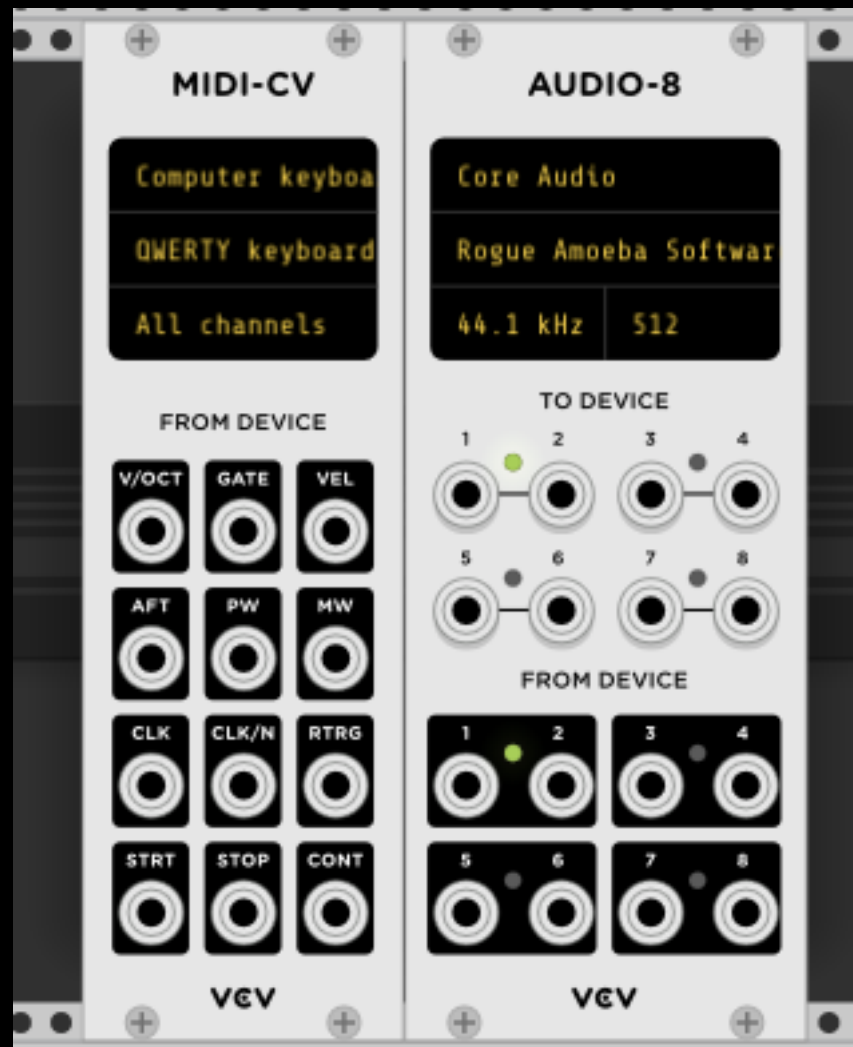

使用 MIDI-CV 與 Audio-8 兩個模組搭上電腦與 VCV 間的橋樑。

MIDI-CV 可以讓我們用電腦鍵盤作為琴鍵輸入，Audio-8 則是聲音輸出必備工具。

在 1.0 版本之後，在 MIDI-CV 上按右鍵可以選擇多發聲數模式（Polyphonic），可以自動把所有對應多發聲的模組變成多發聲數合成器。

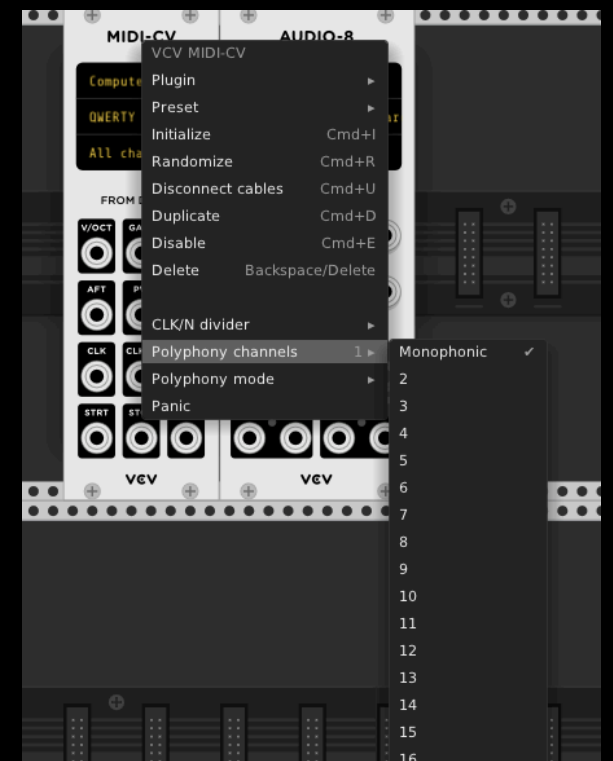

架構減法合成器！

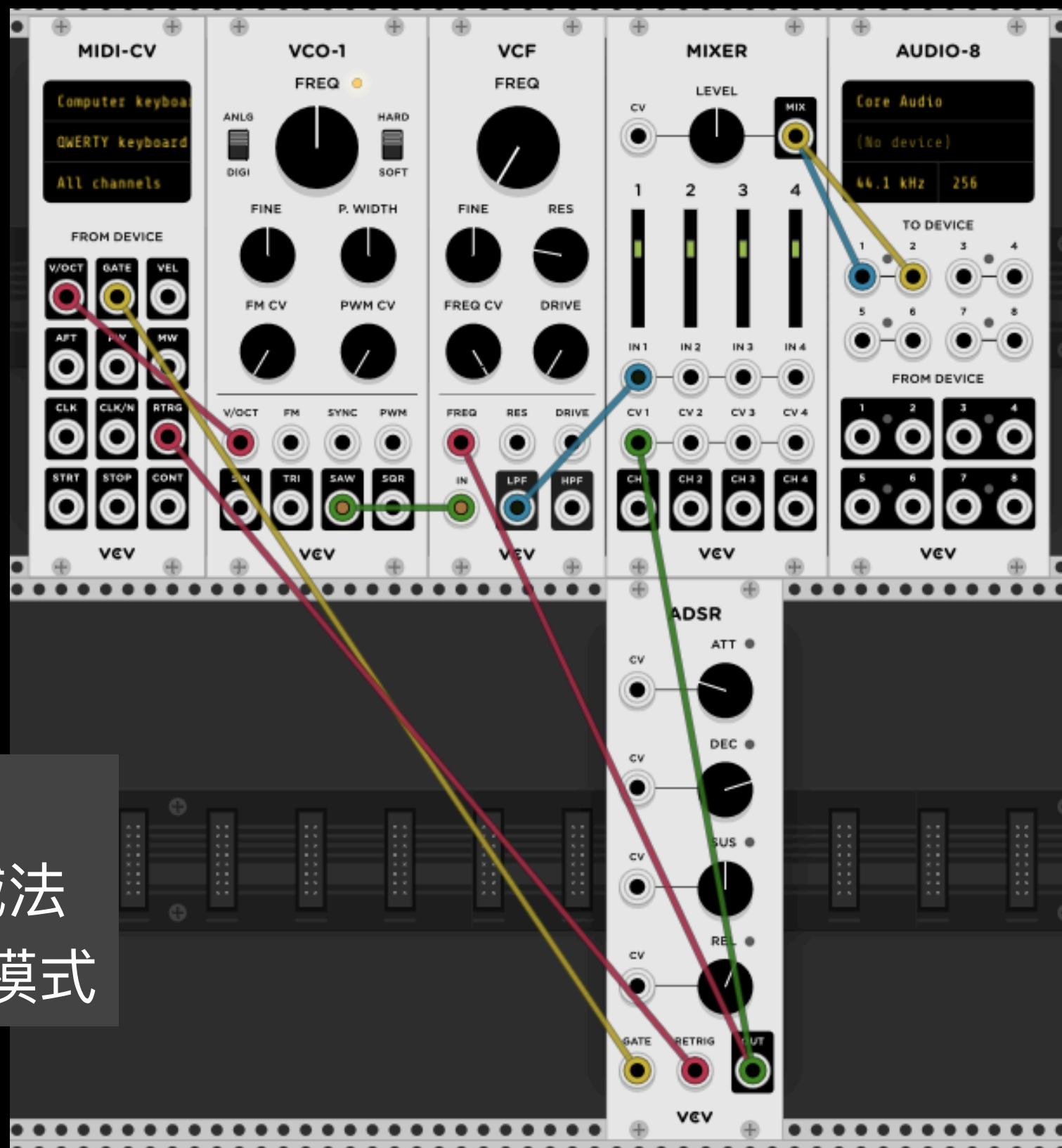

使用簡單的 VCO | VCF |
VCA | ENV 架構基礎的減法
合成器並試著打開 Poly 模式

SEQUENCER !

從 Sequencer 認識模組成器中常見的三種訊號：

CV : Control Voltage, 利用電壓高低控制目標參數高低，例如 1v/oct 或 Filter Freq CV.

Gate : 用不同寬度 (Pulse Width) 控制目標開關，通常送給 Envelope 作進一步處理。

Clock : 一組連續的 Pulse 訊號，通常作為 Sequencer 或 Arpeggiator 的時間來源。



作業 - 製作 FM 合成器

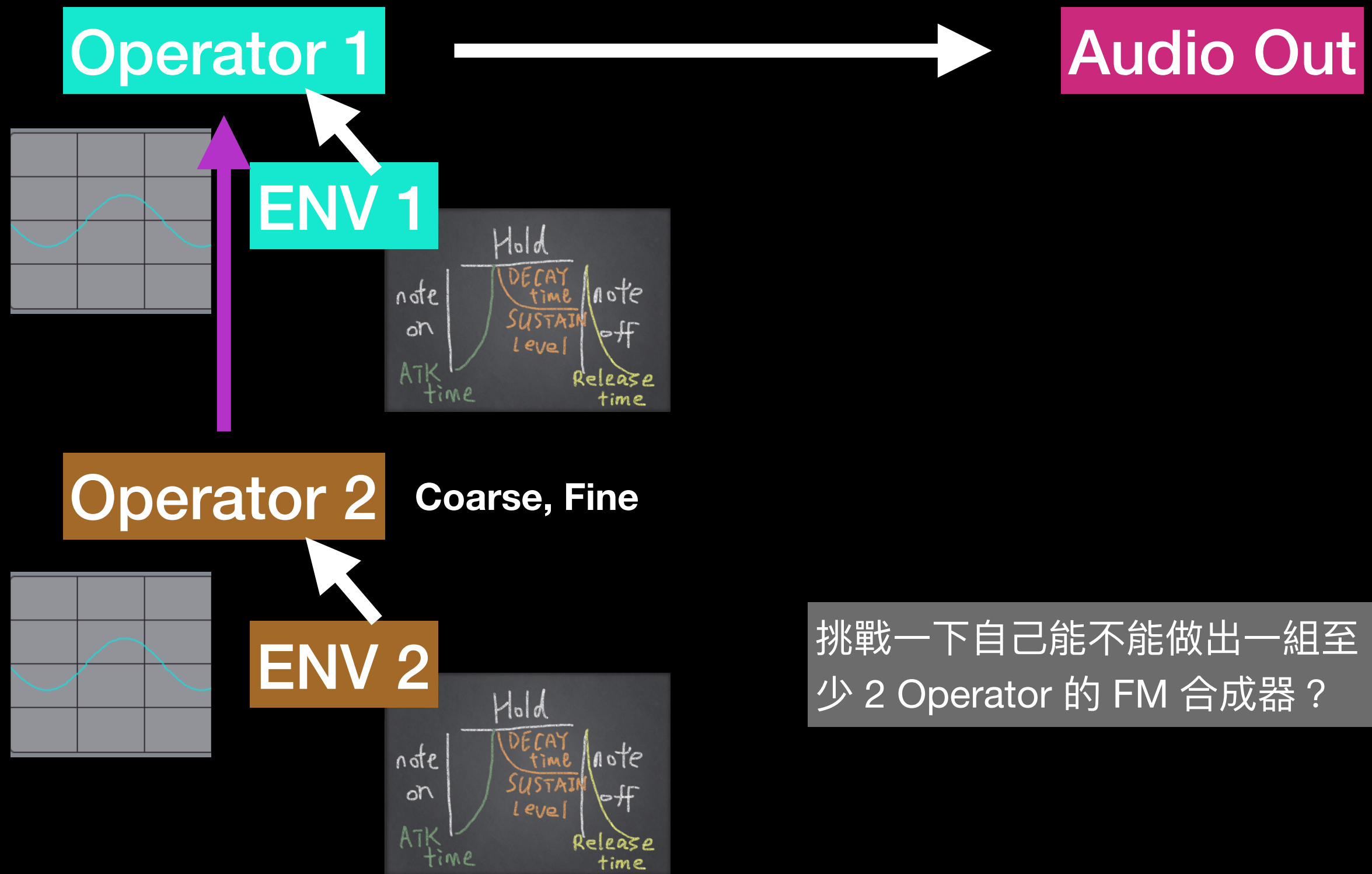

挑戰一下自己能不能做出一組至少 2 Operator 的 FM 合成器？

進階合成法

西岸、物理建模、粒子合成

MADZINE

作業 - 製作 FM 合成器

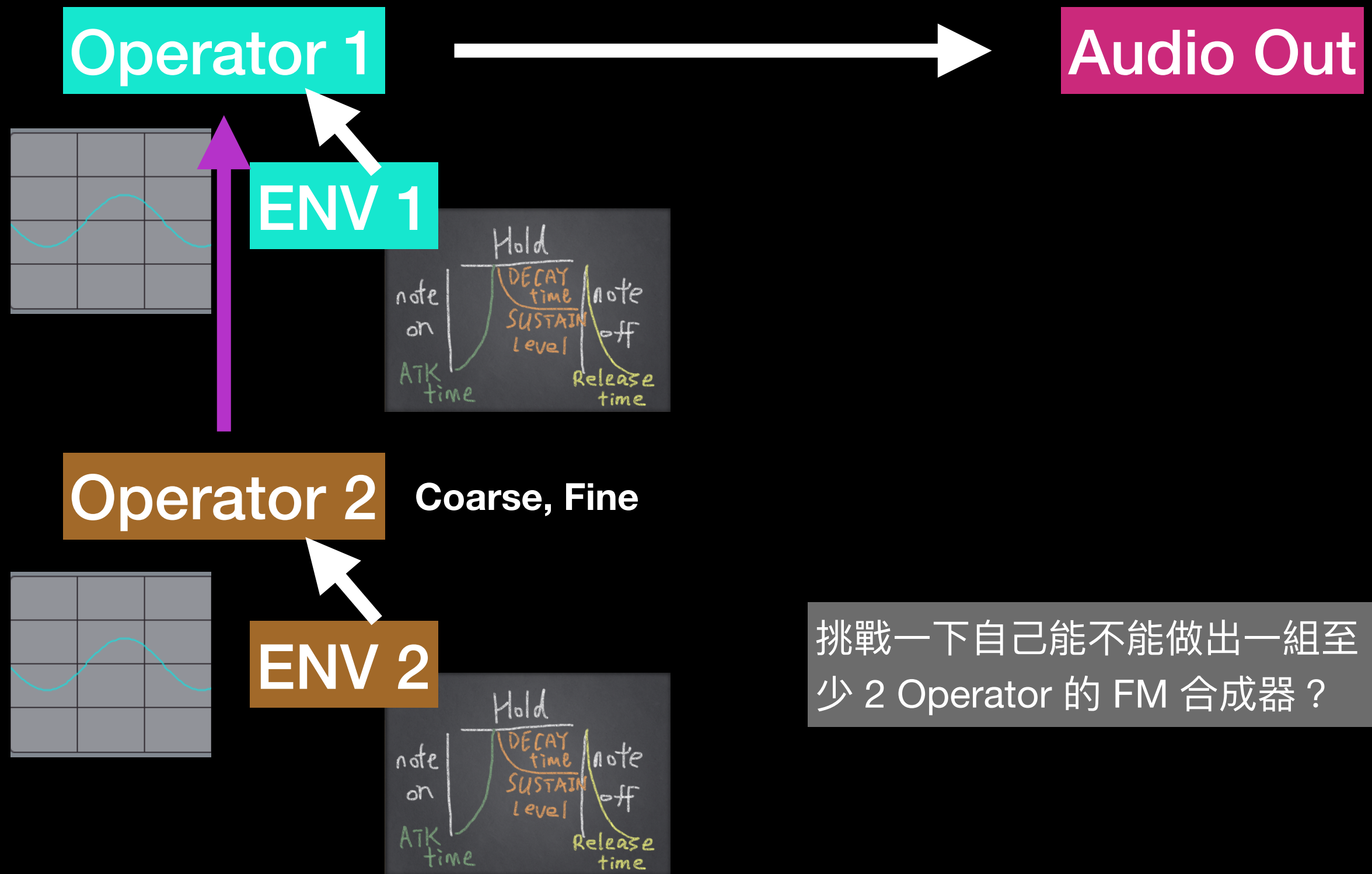

挑戰一下自己能不能做出一組至少 2 Operator 的 FM 合成器？

製作西岸合成器

發聲
Principal OSC

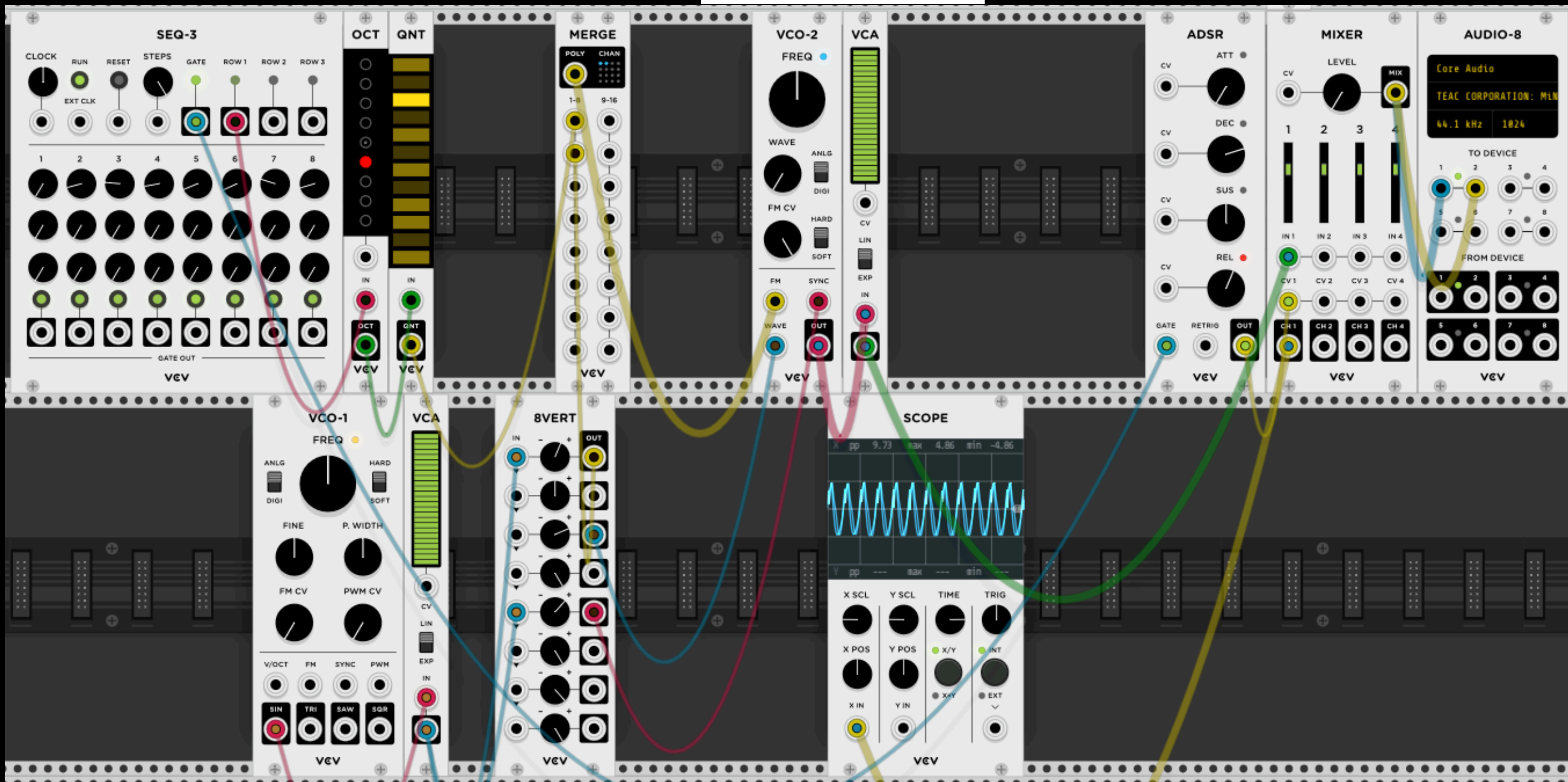

Modulation
Osc

Modulation
Matrix

物理建模 Modeling Synthesis



Elements - 包含三種敲擊方式的物理建模合成器。

Rings - 只能設定敲擊物材質，可以用外部音源去敲打這個物體。

粒子合成 Granulator

Clouds

將輸入的音源切成小碎片，將這些小碎片重複播放成為類似 Delay 的效果或是 Pad 的長音。



完

辛苦了！

MADZINE