

# Chapter 1 • Introduction

**1.1** A gas at 20°C may be *rarefied* if it contains less than  $10^{12}$  molecules per  $\text{mm}^3$ . If Avogadro's number is  $6.023\text{E}23$  molecules per mole, what air pressure does this represent?

**Solution:** The mass of one molecule of air may be computed as

$$m = \frac{\text{Molecular weight}}{\text{Avogadro's number}} = \frac{28.97 \text{ mol}^{-1}}{6.023\text{E}23 \text{ molecules/g} \cdot \text{mol}} = 4.81\text{E}-23 \text{ g}$$

Then the density of air containing  $10^{12}$  molecules per  $\text{mm}^3$  is, in SI units,

$$\begin{aligned} \rho &= \left( 10^{12} \frac{\text{molecules}}{\text{mm}^3} \right) \left( 4.81\text{E}-23 \frac{\text{g}}{\text{molecule}} \right) \\ &= 4.81\text{E}-11 \frac{\text{g}}{\text{mm}^3} = 4.81\text{E}-5 \frac{\text{kg}}{\text{m}^3} \end{aligned}$$

Finally, from the perfect gas law, Eq. (1.13), at  $20^\circ\text{C} = 293 \text{ K}$ , we obtain the pressure:

$$p = \rho RT = \left( 4.81\text{E}-5 \frac{\text{kg}}{\text{m}^3} \right) \left( 287 \frac{\text{m}^2}{\text{s}^2 \cdot \text{K}} \right) (293 \text{ K}) = \mathbf{4.0 \text{ Pa}} \quad \text{Ans.}$$

**1.2** The earth's atmosphere can be modeled as a uniform layer of air of thickness 20 km and average density  $0.6 \text{ kg/m}^3$  (see Table A-6). Use these values to estimate the total mass and total number of molecules of air in the entire atmosphere of the earth.

**Solution:** Let  $R_e$  be the earth's radius  $\approx 6377 \text{ km}$ . Then the total mass of air in the atmosphere is

$$\begin{aligned} m_t &= \int \rho \, d\text{Vol} = \rho_{\text{avg}} (\text{Air Vol}) \approx \rho_{\text{avg}} 4\pi R_e^2 (\text{Air thickness}) \\ &= (0.6 \text{ kg/m}^3) 4\pi (6.377\text{E}6 \text{ m})^2 (20\text{E}3 \text{ m}) \approx \mathbf{6.1\text{E}18 \text{ kg}} \quad \text{Ans.} \end{aligned}$$

Dividing by the mass of one molecule  $\approx 4.8\text{E}-23 \text{ g}$  (see Prob. 1.1 above), we obtain the total number of molecules in the earth's atmosphere:

$$N_{\text{molecules}} = \frac{m(\text{atmosphere})}{m(\text{one molecule})} = \frac{6.1\text{E}21 \text{ grams}}{4.8\text{E}-23 \text{ gm/molecule}} \approx \mathbf{1.3\text{E}44 \text{ molecules}} \quad \text{Ans.}$$

**1.3** For the triangular element in Fig. P1.3, show that a tilted free liquid surface, in contact with an atmosphere at pressure  $p_a$ , must undergo shear stress and hence begin to flow.

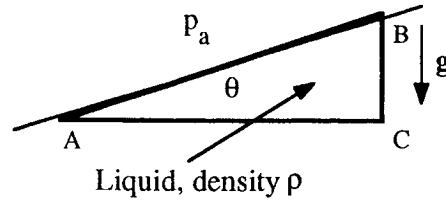
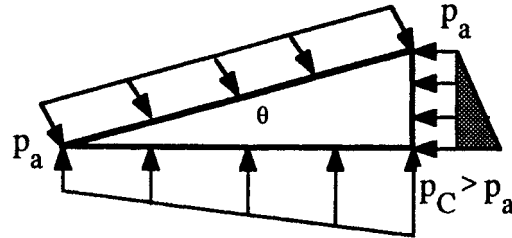


Fig. P1.3

**Solution:** Assume zero shear. Due to element weight, the pressure along the lower and right sides must vary linearly as shown, to a higher value at point C. Vertical forces are presumably in balance with element weight included. But horizontal forces are out of balance, with the unbalanced force being to the left, due to the shaded excess-pressure triangle on the right side BC. Thus hydrostatic pressures cannot keep the element in balance, and shear and flow result.



**1.4** The quantities viscosity  $\mu$ , velocity  $V$ , and surface tension  $Y$  may be combined into a dimensionless group. Find the combination which is proportional to  $\mu$ . This group has a customary name, which begins with  $C$ . Can you guess its name?

**Solution:** The dimensions of these variables are  $\{\mu\} = \{M/LT\}$ ,  $\{V\} = \{L/T\}$ , and  $\{Y\} = \{M/T^2\}$ . We must divide  $\mu$  by  $Y$  to cancel mass  $\{M\}$ , then work the velocity into the group:

$$\left\{ \frac{\mu}{Y} \right\} = \left\{ \frac{M/LT}{M/T^2} \right\} = \left\{ \frac{T}{L} \right\}, \quad \text{hence multiply by } \{V\} = \left\{ \frac{L}{T} \right\};$$

$$\text{finally obtain } \frac{\mu V}{Y} = \text{dimensionless. Ans.}$$

This dimensionless parameter is commonly called the *Capillary Number*.

**1.5** A formula for estimating the mean free path of a perfect gas is:

$$\ell = 1.26 \frac{\mu}{\rho \sqrt{RT}} = 1.26 \frac{\mu}{p} \sqrt{RT} \quad (1)$$

where the latter form follows from the ideal-gas law,  $\rho = p/RT$ . What are the dimensions of the constant “1.26”? Estimate the mean free path of air at 20°C and 7 kPa. Is air *rarefied* at this condition?

**Solution:** We know the dimensions of every term except “1.26”:

$$\{\ell\} = \{L\} \quad \{\mu\} = \left\{ \frac{M}{LT} \right\} \quad \{\rho\} = \left\{ \frac{M}{L^3} \right\} \quad \{R\} = \left\{ \frac{L^2}{T^2\Theta} \right\} \quad \{T\} = \{\Theta\}$$

Therefore the above formula (first form) may be written dimensionally as

$$\{L\} = \{1.26\} \frac{\{M/L \cdot T\}}{\{M/L^3\} \sqrt{[\{L^2/T^2 \cdot \Theta\} \{\Theta\}]}} = \{1.26\} \{L\}$$

Since we have  $\{L\}$  on both sides,  $\{1.26\} = \{\text{unity}\}$ , that is, the constant is dimensionless. The formula is therefore dimensionally homogeneous and should hold for any unit system.

For air at 20°C = 293 K and 7000 Pa, the density is  $\rho = p/RT = (7000)/[(287)(293)] = 0.0832 \text{ kg/m}^3$ . From Table A-2, its viscosity is  $1.80\text{E}-5 \text{ N} \cdot \text{s/m}^2$ . Then the formula predict a mean free path of

$$\ell = 1.26 \frac{1.80\text{E}-5}{(0.0832)[(287)(293)]^{1/2}} \approx \mathbf{9.4\text{E}-7 \text{ m}} \quad \text{Ans.}$$

This is quite small. We would judge this gas to approximate a continuum if the physical scales in the flow are greater than about  $100 \ell$ , that is, greater than about  $94 \mu\text{m}$ .

**1.6** If  $p$  is pressure and  $y$  is a coordinate, state, in the  $\{MLT\}$  system, the dimensions of the quantities (a)  $\partial p / \partial y$ ; (b)  $\int p \, dy$ ; (c)  $\partial^2 p / \partial y^2$ ; (d)  $\nabla p$ .

**Solution:** (a)  $\{ML^{-2}T^{-2}\}$ ; (b)  $\{MT^{-2}\}$ ; (c)  $\{ML^{-3}T^{-2}\}$ ; (d)  $\{ML^{-2}T^{-2}\}$

**1.7** A small village draws 1.5 acre-foot of water per day from its reservoir. Convert this water usage into (a) gallons per minute; and (b) liters per second.

**Solution:** One acre =  $(1 \text{ mi}^2/640) = (5280 \text{ ft})^2/640 = 43560 \text{ ft}^2$ . Therefore 1.5 acre-ft =  $65340 \text{ ft}^3 = 1850 \text{ m}^3$ . Meanwhile, 1 gallon =  $231 \text{ in}^3 = 231/1728 \text{ ft}^3$ . Then 1.5 acre-ft of water per day is equivalent to

$$Q = 65340 \frac{\text{ft}^3}{\text{day}} \left( \frac{1728 \text{ gal}}{231 \text{ ft}^3} \right) \left( \frac{1 \text{ day}}{1440 \text{ min}} \right) \approx \mathbf{340 \frac{\text{gal}}{\text{min}}} \quad \text{Ans. (a)}$$

Similarly,  $1850 \text{ m}^3 = 1.85\text{E}6$  liters. Then a metric unit for this water usage is:

$$Q = \left( 1.85\text{E}6 \frac{\text{L}}{\text{day}} \right) \left( \frac{1}{86400} \frac{\text{day}}{\text{sec}} \right) \approx 21 \frac{\text{L}}{\text{s}} \quad \text{Ans. (b)}$$

**1.8** Suppose that bending stress  $\sigma$  in a beam depends upon bending moment  $M$  and beam area moment of inertia  $I$  and is proportional to the beam half-thickness  $y$ . Suppose also that, for the particular case  $M = 2900 \text{ in}\cdot\text{lb}$ ,  $y = 1.5 \text{ in}$ , and  $I = 0.4 \text{ in}^4$ , the predicted stress is  $75 \text{ MPa}$ . Find the only possible dimensionally homogeneous formula for  $\sigma$ .

**Solution:** We are given that  $\sigma = y \text{ fcn}(M, I)$  and we are *not* to study up on strength of materials but only to use dimensional reasoning. For homogeneity, the right hand side must have dimensions of stress, that is,

$$\{\sigma\} = \{y\} \{\text{fcn}(M, I)\}, \quad \text{or:} \quad \left\{ \frac{\text{M}}{\text{L}\text{T}^2} \right\} = \{\text{L}\} \{\text{fcn}(M, I)\}$$

$$\text{or: the function must have dimensions } \{\text{fcn}(M, I)\} = \left\{ \frac{\text{M}}{\text{L}^2\text{T}^2} \right\}$$

Therefore, to achieve dimensional homogeneity, we somehow must combine bending moment, whose dimensions are  $\{\text{ML}^2\text{T}^{-2}\}$ , with area moment of inertia,  $\{I\} = \{\text{L}^4\}$ , and end up with  $\{\text{ML}^{-2}\text{T}^{-2}\}$ . Well, it is clear that  $\{I\}$  contains neither mass  $\{M\}$  nor time  $\{T\}$  dimensions, but the bending moment contains both mass and time and in exactly the combination we need,  $\{\text{MT}^{-2}\}$ . Thus it must be that  $\sigma$  is proportional to  $M$  also. Now we have reduced the problem to:

$$\sigma = yM \text{ fcn}(I), \quad \text{or} \quad \left\{ \frac{\text{M}}{\text{L}\text{T}^2} \right\} = \{\text{L}\} \left\{ \frac{\text{ML}^2}{\text{T}^2} \right\} \{\text{fcn}(I)\}, \quad \text{or: } \{\text{fcn}(I)\} = \{\text{L}^{-4}\}$$

We need just enough  $I$ 's to give dimensions of  $\{\text{L}^{-4}\}$ : we need the formula to be exactly *inverse* in  $I$ . The correct dimensionally homogeneous beam bending formula is thus:

$$\sigma = C \frac{\text{My}}{I}, \quad \text{where } \{C\} = \{\text{unity}\} \quad \text{Ans.}$$

The formula admits to an arbitrary dimensionless constant  $C$  whose value can only be obtained from known data. Convert stress into English units:  $\sigma = (75 \text{ MPa})/(6894.8) = 10880 \text{ lbf/in}^2$ . Substitute the given data into the proposed formula:

$$\sigma = 10880 \frac{\text{lbf}}{\text{in}^2} = C \frac{\text{My}}{I} = C \frac{(2900 \text{ lbf}\cdot\text{in})(1.5 \text{ in})}{0.4 \text{ in}^4}, \quad \text{or: } C \approx 1.00 \quad \text{Ans.}$$

The data show that  $C = 1$ , or  $\sigma = \text{My}/I$ , our old friend from strength of materials.

**1.9** The dimensionless Galileo number,  $Ga$ , expresses the ratio of gravitational effect to viscous effects in a flow. It combines the quantities density  $\rho$ , acceleration of gravity  $g$ , length scale  $L$ , and viscosity  $\mu$ . Without peeking into another textbook, find the form of the Galileo number if it contains  $g$  in the numerator.

**Solution:** The dimensions of these variables are  $\{\rho\} = \{M/L^3\}$ ,  $\{g\} = \{L/T^2\}$ ,  $\{L\} = \{L\}$ , and  $\{\mu\} = \{M/LT\}$ . Divide  $\rho$  by  $\mu$  to eliminate mass  $\{M\}$  and then combine with  $g$  and  $L$  to eliminate length  $\{L\}$  and time  $\{T\}$ , making sure that  $g$  appears only to the first power:

$$\left\{ \frac{\rho}{\mu} \right\} = \left\{ \frac{M/L^3}{M/LT} \right\} = \left\{ \frac{T}{L^2} \right\}$$

while only  $\{g\}$  contains  $\{T\}$ . To keep  $\{g\}$  to the 1st power, we need to multiply it by  $\{\rho/\mu\}^2$ . Thus  $\{\rho/\mu\}^2\{g\} = \{T^2/L^4\}\{L/T^2\} = \{L^{-3}\}$ .

We then make the combination dimensionless by multiplying the group by  $L^3$ . Thus we obtain:

$$\text{Galileo number} = Ga = \left( \frac{\rho}{\mu} \right)^2 (g)(L)^3 = \frac{\rho^2 g L^3}{\mu^2} = \frac{g L^3}{\nu^2} \quad \text{Ans.}$$

**1.10** The Stokes-Oseen formula [10] for drag on a sphere at low velocity  $V$  is:

$$F = 3\pi\mu DV + \frac{9\pi}{16}\rho V^2 D^2$$

where  $D$  = sphere diameter,  $\mu$  = viscosity, and  $\rho$  = density. Is the formula homogeneous?

**Solution:** Write this formula in dimensional form, using Table 1-2:

$$\{F\} = \{3\pi\}\{\mu\}\{D\}\{V\} + \left\{ \frac{9\pi}{16} \right\} \{\rho\}\{V\}^2\{D\}^2?$$

$$\text{or: } \left\{ \frac{ML}{T^2} \right\} = \{1\} \left\{ \frac{M}{LT} \right\} \{L\} \left\{ \frac{L}{T} \right\} + \{1\} \left\{ \frac{M}{L^3} \right\} \left\{ \frac{L^2}{T^2} \right\} \{L^2\}?$$

where, hoping for homogeneity, we have assumed that all constants ( $3, \pi, 9, 16$ ) are *pure*, i.e.,  $\{\text{unity}\}$ . Well, yes indeed, all terms have dimensions  $\{ML/T^2\}$ ! Therefore the Stokes-Oseen formula (derived in fact from a theory) is **dimensionally homogeneous**.

**1.11** Test, for dimensional homogeneity, the following formula for volume flow  $Q$  through a hole of diameter  $D$  in the side of a tank whose liquid surface is a distance  $h$  above the hole position:

$$Q = 0.68D^2\sqrt{gh}$$

where  $g$  is the acceleration of gravity. What are the dimensions of the constant 0.68?

**Solution:** Write the equation in dimensional form:

$$\{Q\} = \left\{ \frac{L^3}{T} \right\} = \{0.68?\} \{L^2\} \left\{ \frac{L}{T^2} \right\}^{1/2} \{L\}^{1/2} = \{0.68\} \left\{ \frac{L^3}{T} \right\}$$

Thus, since  $D^2\sqrt{gh}$  has provided the correct volume-flow dimensions,  $\{L^3/T\}$ , it follows that the constant “0.68” is indeed dimensionless *Ans.* The formula is dimensionally homogeneous and can be used with any system of units. [The formula is very similar to the valve-flow formula  $Q = C_d A_o \sqrt{(\Delta p/\rho)}$  discussed at the end of Sect. 1.4, and the number “0.68” is proportional to the “discharge coefficient”  $C_d$  for the hole.]

---

**1.12** For low-speed (laminar) flow in a tube of radius  $r_o$ , the velocity  $u$  takes the form

$$u = B \frac{\Delta p}{\mu} (r_o^2 - r^2)$$

where  $\mu$  is viscosity and  $\Delta p$  the pressure drop. What are the dimensions of  $B$ ?

**Solution:** Using Table 1-2, write this equation in dimensional form:

$$\{u\} = \{B\} \frac{\{\Delta p\}}{\{\mu\}} \{r^2\}, \quad \text{or:} \quad \left\{ \frac{L}{T} \right\} = \{B?\} \frac{\{M/LT^2\}}{\{M/LT\}} \{L^2\} = \{B?\} \left\{ \frac{L^2}{T} \right\},$$

$$\text{or:} \quad \{B\} = \{L^{-1}\} \quad \text{Ans.}$$

The parameter  $B$  must have dimensions of inverse length. In fact,  $B$  is not a constant, it hides one of the variables in pipe flow. The proper form of the pipe flow relation is

$$u = C \frac{\Delta p}{L\mu} (r_o^2 - r^2)$$

where  $L$  is the *length of the pipe* and  $C$  is a dimensionless constant which has the theoretical laminar-flow value of  $(1/4)$ —see Sect. 6.4.

---

**1.13** The efficiency  $\eta$  of a pump is defined as

$$\eta = \frac{Q\Delta p}{\text{Input Power}}$$

where  $Q$  is volume flow and  $\Delta p$  the pressure rise produced by the pump. What is  $\eta$  if  $\Delta p = 35$  psi,  $Q = 40$  L/s, and the input power is 16 horsepower?

**Solution:** The student should perhaps verify that  $Q\Delta p$  has units of power, so that  $\eta$  is a dimensionless ratio. Then convert everything to consistent units, for example, BG:

$$Q = 40 \frac{\text{L}}{\text{s}} = 1.41 \frac{\text{ft}^3}{\text{s}}; \quad \Delta p = 35 \frac{\text{lbf}}{\text{in}^2} = 5040 \frac{\text{lbf}}{\text{ft}^2}; \quad \text{Power} = 16(550) = 8800 \frac{\text{ft}\cdot\text{lbf}}{\text{s}}$$

$$\eta = \frac{(1.41 \text{ ft}^3/\text{s})(5040 \text{ lbf}/\text{ft}^2)}{8800 \text{ ft}\cdot\text{lbf}/\text{s}} \approx 0.81 \quad \text{or} \quad \mathbf{81\%} \quad \text{Ans.}$$

Similarly, one could convert to SI units:  $Q = 0.04 \text{ m}^3/\text{s}$ ,  $\Delta p = 241300 \text{ Pa}$ , and input power =  $16(745.7) = 11930 \text{ W}$ , thus  $\eta = (0.04)(241300)/(11930) = \mathbf{0.81}$ . *Ans.*

**1.14** The volume flow  $Q$  over a dam is proportional to dam width  $B$  and also varies with gravity  $g$  and excess water height  $H$  upstream, as shown in Fig. P1.14. What is the only possible dimensionally homogeneous relation for this flow rate?

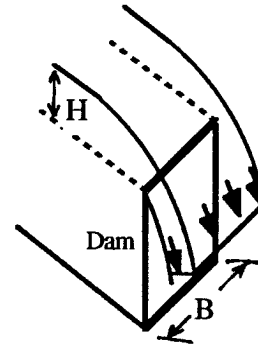


Fig. P1.14

**Solution:** So far we know that  $Q = B \text{ fcn}(H, g)$ . Write this in dimensional form:

$$\{Q\} = \left\{ \frac{\text{L}^3}{\text{T}} \right\} = \{B\} \{f(H, g)\} = \{L\} \{f(H, g)\},$$

$$\text{or: } \{f(H, g)\} = \left\{ \frac{\text{L}^2}{\text{T}} \right\}$$

So the function  $\text{fcn}(H, g)$  must provide dimensions of  $\{L^2/T\}$ , but only  $g$  contains *time*. Therefore  $g$  must enter in the form  $g^{1/2}$  to accomplish this. The relation is now

$$Q = Bg^{1/2} \text{fcn}(H), \quad \text{or: } \{L^3/T\} = \{L\} \{L^{1/2}/T\} \{\text{fcn}(H)\}, \quad \text{or: } \{\text{fcn}(H)\} = \{L^{3/2}\}$$

In order for  $fcn(H)$  to provide dimensions of  $\{L^{3/2}\}$ , the function must be a 3/2 power. Thus the final desired homogeneous relation for dam flow is:

$$Q = CBg^{1/2}H^{3/2}, \quad \text{where } C \text{ is a dimensionless constant} \quad \textit{Ans.}$$

**1.15** As a practical application of Fig. P1.14, often termed a sharp-crested weir, civil engineers use the following formula for flow rate:  $Q \approx 3.3 BH^{3/2}$ , with  $Q$  in  $\text{ft}^3/\text{s}$  and  $B$  and  $H$  in feet. Is this formula dimensionally homogeneous? If not, try to explain the difficulty and how it might be converted to a more homogeneous form.

**Solution:** Clearly the formula *cannot* be dimensionally homogeneous, because  $B$  and  $H$  do not contain the dimension *time*. The formula would be invalid for anything except English units (ft, sec). By comparing with the answer to Prob. 1.14 just above, we see that the constant “3.3” hides the square root of the acceleration of gravity.

**1.16** Test the dimensional homogeneity of the boundary-layer  $x$ -momentum equation:

$$\rho u \frac{\partial u}{\partial x} + \rho v \frac{\partial u}{\partial y} = -\frac{\partial p}{\partial x} + \rho g_x + \frac{\partial \tau}{\partial y}$$

**Solution:** This equation, like **all** theoretical partial differential equations in mechanics, is dimensionally homogeneous. Test each term in sequence:

$$\left\{ \rho u \frac{\partial u}{\partial x} \right\} = \left\{ \rho v \frac{\partial u}{\partial y} \right\} = \frac{M}{L^3} \frac{L}{T} \frac{L}{L} = \left\{ \frac{M}{L^2 T^2} \right\}; \quad \left\{ \frac{\partial p}{\partial x} \right\} = \frac{M/LT^2}{L} = \left\{ \frac{M}{L^2 T^2} \right\}$$

$$\left\{ \rho g_x \right\} = \frac{M}{L^3} \frac{L}{T^2} = \left\{ \frac{M}{L^2 T^2} \right\}; \quad \left\{ \frac{\partial \tau}{\partial x} \right\} = \frac{M/LT^2}{L} = \left\{ \frac{M}{L^2 T^2} \right\}$$

All terms have dimension  $\{ML^{-2}T^{-2}\}$ . This equation may use *any* consistent units.

**1.17** Investigate the consistency of the Hazen-Williams formula from hydraulics:

$$Q = 61.9D^{2.63} \left( \frac{\Delta p}{L} \right)^{0.54}$$

What are the dimensions of the constant “61.9”? Can this equation be used with confidence for a variety of liquids and gases?



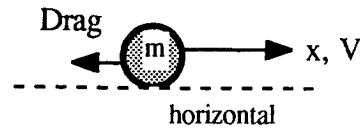
**Solution:** Write out the dimensions of each side of the equation:

$$\{Q\} = \left\{ \frac{L^3}{T} \right\} \stackrel{?}{=} \{61.9\} \{D^{2.63}\} \left\{ \frac{\Delta p}{L} \right\}^{0.54} = \{61.9\} \{L^{2.63}\} \left\{ \frac{M/LT^2}{L} \right\}^{0.54}$$

The constant 61.9 has *fractional* dimensions:  $\{61.9\} = \{L^{1.45}T^{0.08}M^{-0.54}\}$  *Ans.*

Clearly, the formula is extremely inconsistent and cannot be used with confidence for any given fluid or condition or units. Actually, the Hazen-Williams formula, still in common use in the watersupply industry, is valid only for **water** flow in smooth pipes larger than 2-in. diameter and turbulent velocities less than 10 ft/s and (certain) English units. This formula should be held at arm's length and given a vote of "No Confidence."

**1.18\*** (“\*” means “difficult”—not just a plug-and-chug, that is) For small particles at low velocities, the first (linear) term in Stokes’ drag law, Prob. 1.10, is dominant, hence  $F = KV$ , where  $K$  is a constant. Suppose a particle of mass  $m$  is constrained to move horizontally from the initial position  $x = 0$  with initial velocity  $V = V_0$ . Show (a) that its velocity will decrease exponentially with time; and (b) that it will stop after travelling a distance  $x = mV_0/K$ .



**Solution:** Set up and solve the differential equation for forces in the  $x$ -direction:

$$\sum F_x = -\text{Drag} = ma_x, \quad \text{or:} \quad -KV = m \frac{dV}{dt}, \quad \text{integrate } \int_{V_0}^V \frac{dV}{V} = - \int_0^t \frac{m}{K} dt$$

$$\text{Solve } V = V_0 e^{-mt/K} \quad \text{and} \quad x = \int_0^t V dt = \frac{mV_0}{K} (1 - e^{-mt/K}) \quad \text{Ans. (a,b)}$$

Thus, as asked,  $V$  drops off exponentially with time, and, as  $t \rightarrow \infty$ ,  $x = mV_0/K$ .

**1.19** *Marangoni convection* arises when a surface has a difference in surface tension along its length. The dimensionless *Marangoni number*  $M$  is a combination of thermal diffusivity  $\alpha = k/(\rho c_p)$  (where  $k$  is the thermal conductivity), length scale  $L$ , viscosity  $\mu$ , and surface tension difference  $\delta Y$ . If  $M$  is proportional to  $L$ , find its form.

**Solution:** List the dimensions:  $\{\alpha\} = \{L^2/T\}$ ,  $\{L\} = \{L\}$ ,  $\{\mu\} = \{M/LT\}$ ,  $\{\delta Y\} = \{M/T^2\}$ . We divide  $\delta Y$  by  $\mu$  to get rid of mass dimensions, then divide by  $\alpha$  to eliminate time:

$$\left\{ \frac{\delta Y}{\mu} \right\} = \left\{ \frac{M}{T^2} \frac{LT}{M} \right\} = \left\{ \frac{L}{T} \right\}, \quad \text{then} \quad \left\{ \frac{\delta Y}{\mu} \frac{1}{\alpha} \right\} = \left\{ \frac{L}{T} \frac{T}{L^2} \right\} = \left\{ \frac{1}{L} \right\}$$

Multiply by  $L$  and we obtain the Marangoni number:  $M = \frac{\delta Y L}{\mu \alpha}$  *Ans.*

**1.20C** (“C” means computer-oriented, although this one can be done analytically.) A baseball, with  $m = 145$  g, is thrown directly upward from the initial position  $z = 0$  and  $V_o = 45$  m/s. The air drag on the ball is  $CV^2$ , where  $C \approx 0.0010$  N·s<sup>2</sup>/m<sup>2</sup>. Set up a differential equation for the ball motion and solve for the instantaneous velocity  $V(t)$  and position  $z(t)$ . Find the maximum height  $z_{\max}$  reached by the ball and compare your results with the elementary-physics case of zero air drag.

**Solution:** For this problem, we include the *weight* of the ball, for upward motion  $z$ :

$$\Sigma F_z = -ma_z, \quad \text{or:} \quad -CV^2 - mg = m \frac{dV}{dt}, \quad \text{solve} \quad \int_{V_o}^V \frac{dV}{g + CV^2/m} = - \int_0^t dt = -t$$

$$\text{Thus } V = \sqrt{\frac{mg}{C}} \tan\left(\phi - t \sqrt{\frac{Cg}{m}}\right) \quad \text{and} \quad z = \frac{m}{C} \ln\left[\frac{\cos(\phi - t \sqrt{(gC/m)})}{\cos\phi}\right]$$

where  $\phi = \tan^{-1}[V_o \sqrt{(C/mg)}]$ . This is cumbersome, so one might also expect some students simply to *program* the differential equation,  $m(dV/dt) + CV^2 = -mg$ , with a numerical method such as Runge-Kutta.

For the given data  $m = 0.145$  kg,  $V_o = 45$  m/s, and  $C = 0.0010$  N·s<sup>2</sup>/m<sup>2</sup>, we compute

$$\phi = 0.8732 \text{ radians}, \quad \sqrt{\frac{mg}{C}} = 37.72 \frac{\text{m}}{\text{s}}, \quad \sqrt{\frac{Cg}{m}} = 0.2601 \text{ s}^{-1}, \quad \frac{m}{C} = 145 \text{ m}$$

Hence the final analytical formulas are:

$$V\left(\text{in } \frac{\text{m}}{\text{s}}\right) = 37.72 \tan(0.8732 - .2601t)$$

$$\text{and } z(\text{in meters}) = 145 \ln\left[\frac{\cos(0.8732 - 0.2601t)}{\cos(0.8732)}\right]$$

The velocity equals zero when  $t = 0.8732/0.2601 \approx \mathbf{3.36}$  s, whence we evaluate the maximum height of the baseball as  $z_{\max} = 145 \ln[\sec(0.8734)] \approx \mathbf{64.2}$  meters. *Ans.*

For zero drag, from elementary physics formulas,  $V = V_0 - gt$  and  $z = V_0 t - gt^2/2$ , we calculate that

$$t_{\text{max height}} = \frac{V_0}{g} = \frac{45}{9.81} \approx 4.59 \text{ s} \quad \text{and} \quad z_{\text{max}} = \frac{V_0^2}{2g} = \frac{(45)^2}{2(9.81)} \approx 103.2 \text{ m}$$

Thus drag on the baseball reduces the maximum height by 38%. [For this problem I assumed a baseball of diameter 7.62 cm, with a drag coefficient  $C_D \approx 0.36$ .]

**1.21** The dimensionless *Grashof number*,  $Gr$ , is a combination of density  $\rho$ , viscosity  $\mu$ , temperature difference  $\Delta T$ , length scale  $L$ , the acceleration of gravity  $g$ , and the coefficient of volume expansion  $\beta$ , defined as  $\beta = (-1/\rho)(\partial\rho/\partial T)_p$ . If  $Gr$  contains both  $g$  and  $\beta$  in the numerator, what is its proper form?

**Solution:** Recall that  $\{\mu/\rho\} = \{L^2/T\}$  and eliminates mass dimensions. To eliminate temperature, we need the product  $\{\beta\Delta T\} = \{1\}$ . Then  $\{g\}$  eliminates  $\{T\}$ , and  $L^3$  cleans it all up:

$$\text{Thus the dimensionless } Gr = \rho^2 g \beta \Delta T L^3 / \mu^2 \quad \text{Ans.}$$

**1.22\*** According to the theory of Chap. 8, as a uniform stream approaches a cylinder of radius  $R$  along the line  $AB$  shown in Fig. P1.22,  $-\infty < x < -R$ , the velocities are

$$u = U_\infty(1 - R^2/x^2); \quad v = w = 0$$

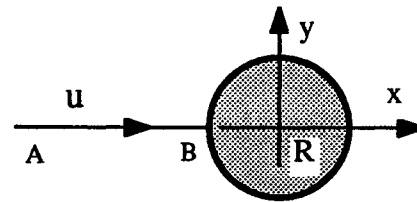


Fig. P1.22

Using the concepts from Ex. 1.5, find (a) the maximum flow deceleration along  $AB$ ; and (b) its location.

**Solution:** We see that  $u$  slows down monotonically from  $U_\infty$  at  $A$  to zero at point  $B$ ,  $x = -R$ , which is a flow “stagnation point.” From Example 1.5, the acceleration  $(du/dt)$  is

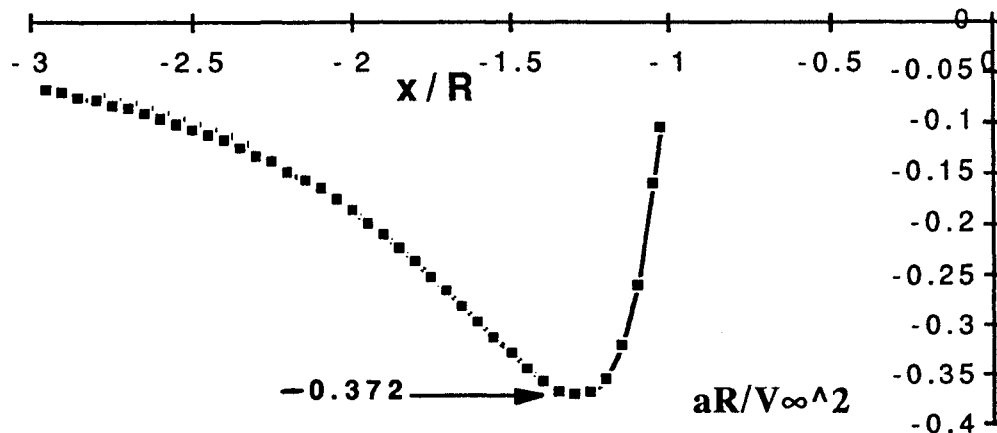
$$\frac{du}{dt} = \frac{\partial u}{\partial t} + u \frac{\partial u}{\partial x} = 0 + U_\infty \left(1 - \frac{R^2}{x^2}\right) \left[ U_\infty \left( + \frac{2R^2}{x^3} \right) \right] = \frac{U_\infty^2}{R} \left( \frac{2}{\zeta^3} - \frac{2}{\zeta^5} \right), \quad \zeta = \frac{x}{R}$$

This acceleration is negative, as expected, and reaches a minimum near point  $B$ , which is found by differentiating the acceleration with respect to  $x$ :

$$\frac{d}{dx} \left( \frac{du}{dt} \right) = 0 \quad \text{if} \quad \zeta^2 = \frac{5}{3}, \quad \text{or} \quad \frac{x}{R} \Big|_{\text{max decel.}} \approx -1.291 \quad \text{Ans. (b)}$$

$$\text{Substituting } \zeta = -1.291 \text{ into } (du/dt) \text{ gives } \frac{du}{dt} \Big|_{\text{min}} = -0.372 \frac{U_\infty^2}{R} \quad \text{Ans. (a)}$$

A plot of the flow deceleration along line AB is shown as follows.



**1.23E** This is an experimental home project, finding the flow rate from a faucet.

**1.24** Consider carbon dioxide at 10 atm and 400°C. Calculate  $\rho$  and  $c_p$  at this state and then estimate the new pressure when the gas is cooled isentropically to 100°C. Use two methods: (a) an ideal gas; and (b) the Gas Tables or EES.

**Solution:** From Table A.4, for CO<sub>2</sub>,  $k \approx 1.30$ , and  $R \approx 189 \text{ m}^2/(\text{s}^2 \cdot \text{K})$ . Convert pressure from  $p_1 = 10 \text{ atm} = 1,013,250 \text{ Pa}$ , and  $T_1 = 400^\circ\text{C} = 673 \text{ K}$ . (a) Then use the ideal gas laws:

$$\rho_1 = \frac{p_1}{RT_1} = \frac{1,013,250 \text{ Pa}}{(189 \text{ m}^2/\text{s}^2 \text{ K})(673 \text{ K})} = \mathbf{7.97} \frac{\text{kg}}{\text{m}^3};$$

$$c_p = \frac{kR}{k-1} = \frac{1.3(189)}{1.3-1} = \mathbf{819} \frac{\text{J}}{\text{kg} \cdot \text{K}} \quad \text{Ans. (a)}$$

For an ideal gas cooled isentropically to  $T_2 = 100^\circ\text{C} = 373 \text{ K}$ , the formula is

$$\frac{p_2}{p_1} = \left( \frac{T_2}{T_1} \right)^{k/(k-1)} = \frac{p_2}{1013 \text{ kPa}} = \left( \frac{373 \text{ K}}{673 \text{ K}} \right)^{1.3/(1.3-1)} = 0.0775, \quad \text{or: } p_2 = \mathbf{79 \text{ kPa}} \quad \text{Ans. (a)}$$

For EES or the Gas Tables, just program the properties for carbon dioxide or look them up:

$$\rho_1 = \mathbf{7.98} \text{ kg/m}^3; \quad c_p = \mathbf{1119} \text{ J/(kg} \cdot \text{K)}; \quad p_2 = \mathbf{43 \text{ kPa}} \quad \text{Ans. (b)}$$

(NOTE: The large errors in “ideal”  $c_p$  and “ideal” final pressure are due to the sharp drop-off in  $k$  of CO<sub>2</sub> with temperature, as seen in Fig. 1.3 of the text.)

**1.25** A tank contains  $0.9 \text{ m}^3$  of helium at 200 kPa and  $20^\circ\text{C}$ . Estimate the total mass of this gas, in kg, (a) on earth; and (b) on the moon. Also, (c) how much heat transfer, in MJ, is required to expand this gas at constant temperature to a new volume of  $1.5 \text{ m}^3$ ?

**Solution:** First find the density of helium for this condition, given  $R = 2077 \text{ m}^2/(\text{s}^2\cdot\text{K})$  from Table A-4. Change  $20^\circ\text{C}$  to 293 K:

$$\rho_{\text{He}} = \frac{p}{R_{\text{He}}T} = \frac{200000 \text{ N/m}^2}{(2077 \text{ J/kg}\cdot\text{K})(293 \text{ K})} \approx 0.3286 \text{ kg/m}^3$$

Now mass is *mass*, no matter where you are. Therefore, on the moon or wherever,

$$m_{\text{He}} = \rho_{\text{He}}v = (0.3286 \text{ kg/m}^3)(0.9 \text{ m}^3) \approx \mathbf{0.296 \text{ kg}} \quad \text{Ans. (a,b)}$$

For part (c), we expand a constant mass isothermally from  $0.9$  to  $1.5 \text{ m}^3$ . The first law of thermodynamics gives

$$dQ_{\text{added}} - dW_{\text{by gas}} = dE = mc_v\Delta T = 0 \quad \text{since } T_2 = T_1 \text{ (isothermal)}$$

Then the heat added equals the work of expansion. Estimate the work done:

$$W_{1-2} = \int_1^2 p \, dv = \int_1^2 \frac{m}{v} RT \, dv = mRT \int_1^2 \frac{dv}{v} = mRT \ln(v_2/v_1),$$

$$\text{or: } W_{1-2} = (0.296 \text{ kg})(2077 \text{ J/kg}\cdot\text{K})(293 \text{ K})\ln(1.5/0.9) = Q_{1-2} \approx \mathbf{92000 \text{ J}} \quad \text{Ans. (c)}$$

**1.26** A tire has a volume of  $3.0 \text{ ft}^3$  and a ‘gage’ pressure of 32 psi at  $75^\circ\text{F}$ . If the ambient pressure is sea-level standard, what is the weight of air in the tire?

**Solution:** Convert the temperature from  $75^\circ\text{F}$  to  $535^\circ\text{R}$ . Convert the pressure to psf:

$$p = (32 \text{ lbf/in}^2)(144 \text{ in}^2/\text{ft}^2) + 2116 \text{ lbf/ft}^2 = 4608 + 2116 \approx 6724 \text{ lbf/ft}^2$$

From this compute the density of the air in the tire:

$$\rho_{\text{air}} = \frac{p}{RT} = \frac{6724 \text{ lbf/ft}^2}{(1717 \text{ ft}\cdot\text{lbf/slug}\cdot^\circ\text{R})(535^\circ\text{R})} = 0.00732 \text{ slug/ft}^3$$

Then the total weight of air in the tire is

$$W_{\text{air}} = \rho g v = (0.00732 \text{ slug/ft}^3)(32.2 \text{ ft/s}^2)(3.0 \text{ ft}^3) \approx \mathbf{0.707 \text{ lbf}} \quad \text{Ans.}$$

**1.27** Given temperature and specific volume data for steam at 40 psia [Ref. 13]:

T, °F:	400	500	600	700	800
v, ft <sup>3</sup> /lbm:	12.624	14.165	15.685	17.195	18.699

Is the ideal gas law reasonable for this data? If so, find a least-squares value for the gas constant R in m<sup>2</sup>/(s<sup>2</sup>·K) and compare with Table A-4.

**Solution:** The units are awkward but we can compute R from the data. At 400°F,

$$\text{“R”}_{400^\circ\text{F}} = \frac{pV}{T} = \frac{(40 \text{ lbf/in}^2)(144 \text{ in}^2/\text{ft}^2)(12.624 \text{ ft}^3/\text{lbm})(32.2 \text{ lbm/slug})}{(400 + 459.6)^\circ\text{R}} \approx 2721 \frac{\text{ft}\cdot\text{lbf}}{\text{slug}\cdot^\circ\text{R}}$$

The metric conversion factor, from the inside cover of the text, is “5.9798”:  $R_{\text{metric}} = 2721/5.9798 = 455.1 \text{ m}^2/(\text{s}^2\cdot\text{K})$ . Not bad! This is only 1.3% less than the ideal-gas approximation for steam in Table A-4: **461** m<sup>2</sup>/(s<sup>2</sup>·K). Let’s try all the five data points:

T, °F:	400	500	600	700	800
R, m <sup>2</sup> /(s <sup>2</sup> ·K):	455	457	459	460	460

The total variation in the data is only ±0.6%. Therefore steam *is* nearly an ideal gas in this (high) temperature range and for this (low) pressure. We can take an average value:

$$p = 40 \text{ psia}, 400^\circ\text{F} \leq T \leq 800^\circ\text{F}: \quad R_{\text{steam}} \approx \frac{1}{5} \sum_{i=1}^5 R_i \approx \mathbf{458 \frac{J}{\text{kg}\cdot\text{K}} \pm 0.6\% \quad \text{Ans.}}$$

With such a small uncertainty, we don’t really *need* to perform a least-squares analysis, but if we wanted to, it would go like this: We wish to minimize, for all data, the sum of the squares of the deviations from the perfect-gas law:

$$\text{Minimize } E = \sum_{i=1}^5 \left( R - \frac{pV_i}{T_i} \right)^2 \quad \text{by differentiating } \frac{\partial E}{\partial R} = 0 = \sum_{i=1}^5 2 \left( R - \frac{pV_i}{T_i} \right)$$

$$\text{Thus } R_{\text{least-squares}} = \frac{p}{5} \sum_{i=1}^5 \frac{V_i}{T_i} = \frac{40(144)}{5} \left[ \frac{12.624}{860^\circ\text{R}} + \dots + \frac{18.699}{1260^\circ\text{R}} \right] (32.2)$$

For this example, then, least-squares amounts to summing the (V/T) values and converting the units. The English result shown above gives  $R_{\text{least-squares}} \approx 2739 \text{ ft}\cdot\text{lbf}/\text{slug}\cdot^\circ\text{R}$ . Convert this to metric units for our (highly accurate) least-squares estimate:

$$R_{\text{steam}} \approx 2739/5.9798 \approx \mathbf{458 \pm 0.6\% \text{ J/kg}\cdot\text{K} \quad \text{Ans.}}$$


---

**1.28** Wet air, at 100% relative humidity, is at 40°C and 1 atm. Using Dalton's law of partial pressures, compute the density of this wet air and compare with dry air.

**Solution:** Change T from 40°C to 313 K. Dalton's law of partial pressures is

$$p_{\text{tot}} = 1 \text{ atm} = p_{\text{air}} + p_{\text{water}} = \frac{m_a}{v} R_a T + \frac{m_w}{v} R_w T$$

$$\text{or: } m_{\text{tot}} = m_a + m_w = \frac{p_a v}{R_a T} + \frac{p_w v}{R_w T} \quad \text{for an ideal gas}$$

where, from Table A-4,  $R_{\text{air}} = 287$  and  $R_{\text{water}} = 461 \text{ m}^2/(\text{s}^2 \cdot \text{K})$ . Meanwhile, from Table A-5, at 40°C, the vapor pressure of saturated (100% humid) water is 7375 Pa, whence the partial pressure of the air is  $p_a = 1 \text{ atm} - p_w = 101350 - 7375 = 93975 \text{ Pa}$ .

Solving for the mixture density, we obtain

$$\rho = \frac{m_a + m_w}{v} = \frac{p_a}{R_a T} + \frac{p_w}{R_w T} = \frac{93975}{287(313)} + \frac{7375}{461(313)} = 1.046 + 0.051 \approx \mathbf{1.10} \frac{\text{kg}}{\text{m}^3} \quad \text{Ans.}$$

By comparison, the density of dry air for the same conditions is

$$\rho_{\text{dry air}} = \frac{p}{RT} = \frac{101350}{287(313)} = 1.13 \frac{\text{kg}}{\text{m}^3}$$

Thus, at 40°C, wet, 100% humidity, air is *lighter* than dry air, by about **2.7%**.

**1.29** A tank holds 5 ft<sup>3</sup> of air at 20°C and 120 psi (gage). Estimate the energy in ft-lbf required to compress this air isothermally from one atmosphere (14.7 psia = 2116 psfa).

**Solution:** Integrate the work of compression, assuming an ideal gas:

$$W_{1-2} = -\int_1^2 p \, dv = -\int_1^2 \frac{mRT}{v} \, dv = -mRT \ln\left(\frac{v_2}{v_1}\right) = p_2 v_2 \ln\left(\frac{p_2}{p_1}\right)$$

where the latter form follows from the ideal gas law for isothermal changes. For the given numerical data, we obtain the quantitative work done:

$$W_{1-2} = p_2 v_2 \ln\left(\frac{p_2}{p_1}\right) = \left(134.7 \times 144 \frac{\text{lbf}}{\text{ft}^2}\right) (5 \text{ ft}^3) \ln\left(\frac{134.7}{14.7}\right) \approx \mathbf{215,000 \text{ ft} \cdot \text{lbf}} \quad \text{Ans.}$$

**1.30** Repeat Prob. 1.29 if the tank is filled with compressed *water* rather than air. Why is the result thousands of times less than the result of 215,000 ft·lbf in Prob. 1.29?

**Solution:** First evaluate the density change of water. At 1 atm,  $\rho_o \approx 1.94$  slug/ft<sup>3</sup>. At 120 psi(gage) = 134.7 psia, the density would rise slightly according to Eq. (1.22):

$$\frac{p}{p_o} = \frac{134.7}{14.7} \approx 3001 \left( \frac{\rho}{1.94} \right)^7 - 3000, \quad \text{solve } \rho \approx 1.940753 \text{ slug/ft}^3,$$

$$\text{Hence } m_{\text{water}} = \rho v = (1.940753)(5 \text{ ft}^3) \approx 9.704 \text{ slug}$$

The density change is extremely small. Now the work done, as in Prob. 1.29 above, is

$$W_{1-2} = -\int_1^2 p dv = \int_1^2 p d\left(\frac{m}{\rho}\right) = \int_1^2 p \frac{m d\rho}{\rho^2} \approx p_{\text{avg}} m \frac{\Delta\rho}{\rho_{\text{avg}}^2} \quad \text{for a linear pressure rise}$$

$$\text{Hence } W_{1-2} \approx \left( \frac{14.7 + 134.7}{2} \times 144 \frac{\text{lbf}}{\text{ft}^2} \right) (9.704 \text{ slug}) \left( \frac{0.000753}{1.9404^2} \frac{\text{ft}^3}{\text{slug}} \right) \approx \mathbf{21 \text{ ft}\cdot\text{lbf}} \quad \text{Ans.}$$

[Exact integration of Eq. (1.22) would give the same numerical result.] Compressing water (extremely small  $\Delta\rho$ ) takes *ten thousand times less energy* than compressing air, which is why it is safe to test high-pressure systems with water but dangerous with air.

**1.31** The density of water for  $0^\circ\text{C} < T < 100^\circ\text{C}$  is given in Table A-1. Fit this data to a least-squares parabola,  $\rho = a + bT + cT^2$ , and test its accuracy *vis-a-vis* Table A-1. Finally, compute  $\rho$  at  $T = 45^\circ\text{C}$  and compare your result with the accepted value of  $\rho \approx 990.1 \text{ kg/m}^3$ .

**Solution:** The least-squares parabola which fits the data of Table A-1 is:

$$\rho \text{ (kg/m}^3\text{)} \approx 1000.6 - 0.06986T - 0.0036014T^2, \quad T \text{ in } ^\circ\text{C} \quad \text{Ans.}$$

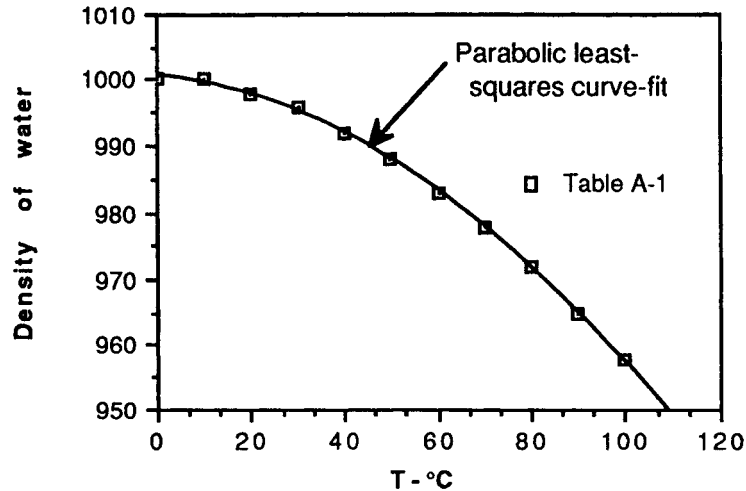
When compared with the data, the accuracy is less than  $\pm 1\%$ . When evaluated at the particular temperature of  $45^\circ\text{C}$ , we obtain

$$\rho_{45^\circ\text{C}} \approx 1000.6 - 0.06986(45) - 0.003601(45)^2 \approx \mathbf{990.2 \text{ kg/m}^3} \quad \text{Ans.}$$

This is excellent accuracy—a good fit to good smooth data.

The data and the parabolic curve-fit are shown plotted on the next page. The curve-fit does not display the known fact that  $\rho$  for fresh water is a *maximum* at  $T = +4^\circ\text{C}$ .





**1.32** A blimp is approximated by a prolate spheroid 90 m long and 30 m in diameter. Estimate the weight of 20°C gas within the blimp for (a) helium at 1.1 atm; and (b) air at 1.0 atm. What might the difference between these two values represent (Chap. 2)?

**Solution:** Find a handbook. The volume of a prolate spheroid is, for our data,

$$v = \frac{2}{3}\pi LR^2 = \frac{2}{3}\pi(90\text{ m})(15\text{ m})^2 \approx 42412\text{ m}^3$$

Estimate, from the ideal-gas law, the respective densities of helium and air:

$$(a) \quad \rho_{\text{helium}} = \frac{p_{\text{He}}}{R_{\text{He}}T} = \frac{1.1(101350)}{2077(293)} \approx 0.1832 \frac{\text{kg}}{\text{m}^3};$$

$$(b) \quad \rho_{\text{air}} = \frac{p_{\text{air}}}{R_{\text{air}}T} = \frac{101350}{287(293)} \approx 1.205 \frac{\text{kg}}{\text{m}^3}.$$

Then the respective gas weights are

$$W_{\text{He}} = \rho_{\text{He}}g v = \left(0.1832 \frac{\text{kg}}{\text{m}^3}\right) \left(9.81 \frac{\text{m}}{\text{s}^2}\right) (42412\text{ m}^3) \approx \mathbf{76000\text{ N}} \quad \text{Ans. (a)}$$

$$W_{\text{air}} = \rho_{\text{air}}g v = (1.205)(9.81)(42412) \approx \mathbf{501000\text{ N}} \quad \text{Ans. (b)}$$

The difference between these two, **425000 N**, is the *buoyancy*, or lifting ability, of the blimp. [See Section 2.8 for the principles of buoyancy.]

**1.33** Experimental data for density of mercury versus pressure at 20°C are as follows:

p, atm:	1	500	1000	1500	2000
$\rho$ , kg/m <sup>3</sup> :	13545	13573	13600	13625	13653

Fit this data to the empirical state relation for liquids, Eq. (1.19), to find the best values of  $B$  and  $n$  for mercury. Then, assuming the data are nearly isentropic, use these values to estimate the speed of sound of mercury at 1 atm and compare with Table 9.1.

**Solution:** This can be done (laboriously) by the method of least-squares, but we can also do it on a spreadsheet by guessing, say,  $n \approx 4,5,6,7,8$  and finding the average  $B$  for each case. For this data, almost *any* value of  $n > 1$  is reasonably accurate. We select:

$$\text{Mercury: } n \approx 7, \quad B \approx 35000 \pm 2\% \quad \text{Ans.}$$

The speed of sound is found by differentiating Eq. (1.19) and then taking the square root:

$$\frac{dp}{d\rho} \approx \frac{p_o}{\rho_o} n(B+1) \left( \frac{\rho}{\rho_o} \right)^{n-1}, \quad \text{hence } a|_{\rho=\rho_o} \approx \left[ \frac{n(B+1)p_o}{\rho_o} \right]^{1/2}$$

it being assumed here that this equation of state is “isentropic.” Evaluating this relation for mercury’s values of  $B$  and  $n$ , we find the speed of sound at 1 atm:

$$a_{\text{mercury}} \approx \left[ \frac{(7)(35001)(101350 \text{ N/m}^2)}{13545 \text{ kg/m}^3} \right]^{1/2} \approx 1355 \text{ m/s} \quad \text{Ans.}$$

This is about 7% less than the value of 1450 m/s listed in Table 9.1 for mercury.

**1.34** Consider steam at the following state near the saturation line:  $(p_1, T_1) = (1.31 \text{ MPa}, 290^\circ\text{C})$ . Calculate and compare, for an ideal gas (Table A.4) and the Steam Tables (or the EES software), (a) the density  $\rho_1$ ; and (b) the density  $\rho_2$  if the steam expands isentropically to a new pressure of 414 kPa. Discuss your results.

**Solution:** From Table A.4, for steam,  $k \approx 1.33$ , and  $R \approx 461 \text{ m}^2/(\text{s}^2 \cdot \text{K})$ . Convert  $T_1 = 563 \text{ K}$ . Then,

$$\rho_1 = \frac{p_1}{RT_1} = \frac{1,310,000 \text{ Pa}}{(461 \text{ m}^2/\text{s}^2 \text{K})(563 \text{ K})} = 5.05 \frac{\text{kg}}{\text{m}^3} \quad \text{Ans. (a)}$$

$$\frac{\rho_2}{\rho_1} = \frac{p_2}{p_1} = \left( \frac{p_2}{p_1} \right)^{1/k} = \left( \frac{414 \text{ kPa}}{1310 \text{ kPa}} \right)^{1/1.33} = 0.421, \quad \text{or: } \rho_2 = 2.12 \frac{\text{kg}}{\text{m}^3} \quad \text{Ans. (b)}$$

For EES or the Steam Tables, just program the properties for steam or look it up:

$$\text{EES real steam: } \rho_1 = \mathbf{5.23} \text{ kg/m}^3 \quad \text{Ans. (a),} \quad \rho_2 = \mathbf{2.16} \text{ kg/m}^3 \quad \text{Ans. (b)}$$

The ideal-gas error is only about 3%, even though the expansion approached the saturation line.

---

**1.35** In Table A-4, most common gases (air, nitrogen, oxygen, hydrogen, CO, NO) have a specific heat ratio  $k = 1.40$ . Why do argon and helium have such high values? Why does  $\text{NH}_3$  have such a low value? What is the lowest  $k$  for any gas that you know?

**Solution:** In elementary kinetic theory of gases [8],  $k$  is related to the number of “degrees of freedom” of the gas:  $k \approx 1 + 2/N$ , where  $N$  is the number of different modes of translation, rotation, and vibration possible for the gas molecule.

Example: Monatomic gas,  $N = 3$  (translation only), thus  $k \approx 5/3$

This explains why helium and argon, which are monatomic gases, have  $k \approx 1.67$ .

Example: Diatomic gas,  $N = 5$  (translation plus 2 rotations), thus  $k \approx 7/5$

This explains why air, nitrogen, oxygen, NO, CO and hydrogen have  $k \approx 1.40$ .

But  $\text{NH}_3$  has *four* atoms and therefore more than 5 degrees of freedom, hence  $k$  will be less than 1.40 (the theory is not too clear what “ $N$ ” is for such complex molecules).

The lowest  $k$  known to this writer is for *uranium hexafluoride*,  $^{238}\text{UF}_6$ , which is a very complex, heavy molecule with many degrees of freedom. The estimated value of  $k$  for this heavy gas is  $k \approx \mathbf{1.06}$ .

---

**1.36** The *bulk modulus* of a fluid is defined as  $B = \rho(\partial p/\partial \rho)_S$ . What are the dimensions of  $B$ ? Estimate  $B$  (in Pa) for (a)  $\text{N}_2\text{O}$ , and (b) water, at  $20^\circ\text{C}$  and 1 atm.

**Solution:** The density units cancel in the definition of  $B$  and thus its dimensions are the same as pressure or stress:

$$\{B\} = \{p\} = \{F/L^2\} = \left\{ \frac{\mathbf{M}}{\mathbf{LT}^2} \right\} \quad \text{Ans.}$$

(a) For an ideal gas,  $p = C\rho^k$  for an isentropic process, thus the bulk modulus is:

$$\text{Ideal gas: } B = \rho \frac{d}{d\rho}(C\rho^k) = \rho k C \rho^{k-1} = k C \rho^k = \mathbf{k p}$$

For  $\text{N}_2\text{O}$ , from Table A-4,  $k \approx 1.31$ , so  $B_{\text{N}_2\text{O}} = 1.31 \text{ atm} = \mathbf{1.33E5 Pa}$  Ans. (a)

For water at 20°C, we could just look it up in Table A-3, but we more usefully try to estimate B from the state relation (1-22). Thus, for a liquid, approximately,

$$B \approx \rho \frac{d}{d\rho} [p_o \{ (B+1)(\rho/\rho_o)^n - B \}] = n(B+1)p_o(\rho/\rho_o)^n = n(B+1)p_o \quad \text{at 1 atm}$$

For water,  $B \approx 3000$  and  $n \approx 7$ , so our estimate is

$$B_{\text{water}} \approx 7(3001)p_o = 21007 \text{ atm} \approx \mathbf{2.13E9 \text{ Pa}} \quad \text{Ans. (b)}$$

This is 2.7% less than the value  $B = 2.19E9 \text{ Pa}$  listed in Table A-3.

**1.37** A near-ideal gas has  $M = 44$  and  $c_v = 610 \text{ J/(kg}\cdot\text{K)}$ . At 100°C, what are (a) its specific heat ratio, and (b) its speed of sound?

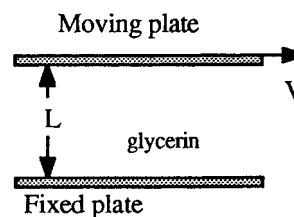
**Solution:** The gas constant is  $R = \Lambda/M = 8314/44 \approx 189 \text{ J/(kg}\cdot\text{K)}$ . Then

$$c_v = R/(k-1), \quad \text{or: } k = 1 + R/c_v = 1 + 189/610 \approx \mathbf{1.31} \quad \text{Ans. (a)} \quad [\text{It is probably } \text{N}_2\text{O}]$$

With  $k$  and  $R$  known, the speed of sound at 100°C = 373 K is estimated by

$$a = \sqrt{kRT} = \sqrt{1.31[189 \text{ m}^2/(\text{s}^2 \cdot \text{K})](373 \text{ K})} \approx \mathbf{304 \text{ m/s}} \quad \text{Ans. (b)}$$

**1.38** In Fig. P1.38, if the fluid is glycerin at 20°C and the width between plates is 6 mm, what shear stress (in Pa) is required to move the upper plate at  $V = 5.5 \text{ m/s}$ ? What is the flow Reynolds number if “L” is taken to be the distance between plates?



**Fig. P1.38**

**Solution:** (a) For glycerin at 20°C, from Table 1.4,  $\mu \approx 1.5 \text{ N}\cdot\text{s/m}^2$ . The shear stress is found from Eq. (1) of Ex. 1.8:

$$\tau = \frac{\mu V}{h} = \frac{(1.5 \text{ Pa}\cdot\text{s})(5.5 \text{ m/s})}{(0.006 \text{ m})} \approx \mathbf{1380 \text{ Pa}} \quad \text{Ans. (a)}$$

The density of glycerin at 20°C is  $1264 \text{ kg/m}^3$ . Then the Reynolds number is defined by Eq. (1.24), with  $L = h$ , and is found to be decidedly laminar,  $\text{Re} < 1500$ :

$$\text{Re}_L = \frac{\rho VL}{\mu} = \frac{(1264 \text{ kg/m}^3)(5.5 \text{ m/s})(0.006 \text{ m})}{1.5 \text{ kg/m}\cdot\text{s}} \approx \mathbf{28} \quad \text{Ans. (b)}$$

**1.39** Knowing  $\mu \approx 1.80\text{E-}5$  Pa·s for air at 20°C from Table 1-4, estimate its viscosity at 500°C by (a) the Power-law, (b) the Sutherland law, and (c) the Law of Corresponding States, Fig. 1.5. Compare with the accepted value  $\mu(500^\circ\text{C}) \approx 3.58\text{E-}5$  Pa·s.

**Solution:** First change T from 500°C to 773 K. (a) For the Power-law for air,  $n \approx 0.7$ , and from Eq. (1.30a),

$$\mu = \mu_o (T/T_o)^n \approx (1.80\text{E-}5) \left( \frac{773}{293} \right)^{0.7} \approx \mathbf{3.55\text{E-}5} \frac{\mathbf{kg}}{\mathbf{m}\cdot\mathbf{s}} \quad \text{Ans. (a)}$$

This is less than 1% low. (b) For the Sutherland law, for air,  $S \approx 110$  K, and from Eq. (1.30b),

$$\begin{aligned} \mu &= \mu_o \left[ \frac{(T/T_o)^{1.5} (T_o + S)}{(T + S)} \right] \approx (1.80\text{E-}5) \left[ \frac{(773/293)^{1.5} (293 + 110)}{(773 + 110)} \right] \\ &= \mathbf{3.52\text{E-}5} \frac{\mathbf{kg}}{\mathbf{m}\cdot\mathbf{s}} \quad \text{Ans. (b)} \end{aligned}$$

This is only 1.7% low. (c) Finally use Fig. 1.5. Critical values for air from Ref. 3 are:

$$\text{Air: } \mu_c \approx 1.93\text{E-}5 \text{ Pa}\cdot\text{s} \quad T_c \approx 132 \text{ K} \quad (\text{“mixture” estimates})$$

At 773 K, the temperature ratio is  $T/T_c = 773/132 \approx 5.9$ . From Fig. 1.5, read  $\mu/\mu_c \approx 1.8$ . Then our critical-point-correlation estimate of air viscosity is only 3% low:

$$\mu \approx 1.8\mu_c = (1.8)(1.93\text{E-}5) \approx \mathbf{3.5\text{E-}5} \frac{\mathbf{kg}}{\mathbf{m}\cdot\mathbf{s}} \quad \text{Ans. (c)}$$

**1.40** Curve-fit the viscosity data for water in Table A-1 in the form of Andrade’s equation,

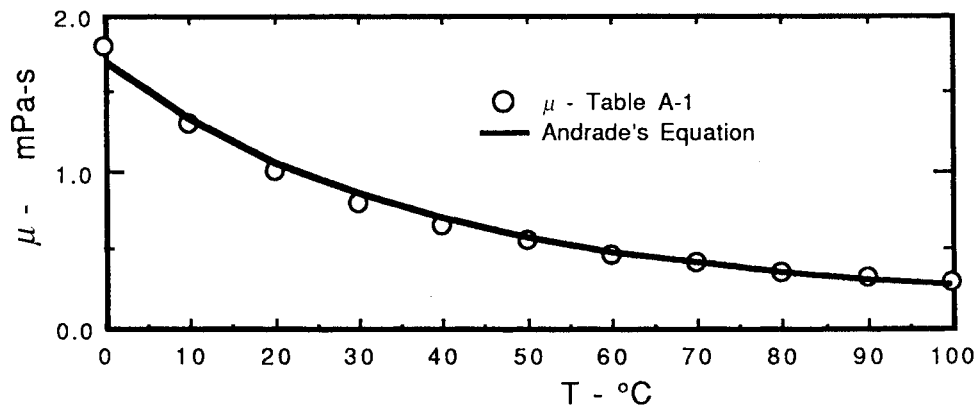
$$\mu \approx A \exp\left(\frac{B}{T}\right) \quad \text{where } T \text{ is in } ^\circ\text{K} \text{ and } A \text{ and } B \text{ are curve-fit constants.}$$

**Solution:** This is an alternative formula to the log-quadratic law of Eq. (1.31). We have eleven data points for water from Table A-1 and can perform a least-squares fit to Andrade’s equation:

$$\text{Minimize } E = \sum_{i=1}^{11} [\mu_i - A \exp(B/T_i)]^2, \quad \text{then set } \frac{\partial E}{\partial A} = 0 \quad \text{and} \quad \frac{\partial E}{\partial B} = 0$$

The result of this minimization is:  $\mathbf{A \approx 0.0016 \text{ kg/m}\cdot\text{s}}$ ,  $\mathbf{B \approx 1903^\circ\text{K}}$ . *Ans.*

The data and the Andrade's curve-fit are plotted. The error is  $\pm 7\%$ , so Andrade's equation is not as accurate as the log-quadratic correlation of Eq. (1.31).



**1.41** Some experimental values of  $\mu$  for argon gas at 1 atm are as follows:

T, °K:	300	400	500	600	700	800
$\mu$ , kg/m·s:	2.27E-5	2.85E-5	3.37E-5	3.83E-5	4.25E-5	4.64E-5

Fit these values to either (a) a Power-law, or (b) a Sutherland law, Eq. (1.30a,b).

**Solution:** (a) The Power-law is straightforward: put the values of  $\mu$  and T into, say, “Cricket Graph”, take logarithms, plot them, and make a linear curve-fit. The result is:

$$\text{Power-law fit: } \mu \approx 2.29\text{E-}5 \left( \frac{T \text{ °K}}{300 \text{ K}} \right)^{0.73} \quad \text{Ans. (a)}$$

Note that the constant “2.29E-5” is slightly higher than the actual viscosity “2.27E-5” at T = 300 K. The accuracy is  $\pm 1\%$  and would be poorer if we replaced 2.29E-5 by 2.27E-5.

(b) For the Sutherland law, unless we rewrite the law (1.30b) drastically, we don't have a simple way to perform a linear least-squares correlation. However, it is no trouble to perform the least-squares summation,  $E = \sum [\mu_i - \mu_0(T_i/300)^{1.5}(300 + S)/(T_i + S)]^2$  and minimize by setting  $\partial E/\partial S = 0$ . We can try  $\mu_0 = 2.27\text{E-}5$  kg/m·s for starters, and it works fine. The best-fit value of  $S \approx 143^\circ\text{K}$  with negligible error. Thus the result is:

$$\text{Sutherland law: } \frac{\mu}{2.27\text{E-}5 \text{ kg/m}\cdot\text{s}} \approx \frac{(T/300)^{1.5} (300 + 143 \text{ K})}{(T + 143 \text{ K})} \quad \text{Ans. (b)}$$

We may tabulate the data and the two curve-fits as follows:

T, °K:	300	400	500	600	700	800
$\mu \times E5$ , data:	2.27	2.85	3.37	3.83	4.25	4.64
$\mu \times E5$ , Power-law:	2.29	2.83	3.33	3.80	4.24	4.68
$\mu \times E5$ , Sutherland:	2.27	2.85	3.37	3.83	4.25	4.64

**1.42** Some experimental values of  $\mu$  of helium at 1 atm are as follows:

T, °K:	200	400	600	800	1000	1200
$\mu$ , kg/m·s:	1.50E-5	2.43E-5	3.20E-5	3.88E-5	4.50E-5	5.08E-5

Fit these values to either (a) a Power-law, or (b) a Sutherland law, Eq. (1.30a,b).

**Solution:** (a) The Power-law is straightforward: put the values of  $\mu$  and T into, say, “Cricket Graph,” take logarithms, plot them, and make a linear curve-fit. The result is:

$$\text{Power-law curve-fit: } \mu_{\text{He}} \approx 1.505E-5 \left( \frac{T \text{ °K}}{200 \text{ K}} \right)^{0.68} \quad \text{Ans. (a)}$$

The accuracy is less than  $\pm 1\%$ . (b) For the Sutherland fit, we can emulate Prob. 1.41 and perform the least-squares summation,  $E = \sum [\mu_i - \mu_0(T_i/200)^{1.5}(200 + S)/(T_i + S)]^2$  and minimize by setting  $\partial E/\partial S = 0$ . We can try  $\mu_0 = 1.50E-5$  kg/m·s and  $T_0 = 200^\circ\text{K}$  for starters, and it works OK. The best-fit value of  $S \approx 95.1^\circ\text{K}$ . Thus the result is:

$$\text{Sutherland law: } \frac{\mu_{\text{Helium}}}{1.50E-5 \text{ kg/m}\cdot\text{s}} \approx \frac{(T/200)^{1.5} (200 + 95.1^\circ\text{K})}{(T + 95.1^\circ\text{K})} \pm 4\% \quad \text{Ans. (b)}$$

For the complete range 200–1200°K, the Power-law is a better fit. The Sutherland law improves to  $\pm 1\%$  if we drop the data point at 200°K.

**1.43** Yaws et al. [ref. 34] suggest a 4-constant curve-fit formula for liquid viscosity:

$$\log_{10} \mu \approx A + B/T + CT + DT^2, \quad \text{with T in absolute units.}$$

(a) Can this formula be criticized on dimensional grounds? (b) If we use the formula anyway, how do we evaluate A,B,C,D in the least-squares sense for a set of N data points?

**Solution:** (a) Yes, if you're a purist: A is dimensionless, but B,C,D are not. It would be more comfortable to this writer to write the formula in terms of some reference temperature  $T_0$ :

$$\log_{10} \mu \approx A + B(T_0/T) + C(T/T_0) + D(T/T_0)^2, \quad (\text{dimensionless } A, B, C, D)$$

(b) For least squares, express the square error as a summation of data-vs-formula differences:

$$E = \sum_{i=1}^N \left[ A + B/T_i + CT_i + DT_i^2 - \log_{10} \mu_i \right]^2 = \sum_{i=1}^N f_i^2 \quad \text{for short.}$$

Then evaluate  $\partial E/\partial A = 0$ ,  $\partial E/\partial B = 0$ ,  $\partial E/\partial C = 0$ , and  $\partial E/\partial D = 0$ , to give four simultaneous linear algebraic equations for (A,B,C,D):

$$\begin{aligned} \sum f_i &= 0; & \sum f_i/T_i &= 0; & \sum f_i T_i &= 0; & \sum f_i T_i^2 &= 0, \\ \text{where } f_i &= A + B/T_i + CT_i + DT_i^2 - \log_{10} \mu_i \end{aligned}$$

Presumably this was how Yaws et al. [34] computed (A,B,C,D) for 355 organic liquids.

**1.44** The viscosity of SAE 30 oil may vary considerably, according to industry-agreed specifications [*SAE Handbook*, Ref. 26]. Comment on the following data and fit the data to Andrade's equation from Prob. 1.41.

T, °C:	0	20	40	60	80	100
$\mu_{\text{SAE30}}$ , kg/m·s:	2.00	0.40	0.11	0.042	0.017	0.0095

**Solution:** At lower temperatures,  $0^\circ\text{C} < T < 60^\circ\text{C}$ , these values are up to fifty per cent higher than the curve labelled "SAE 30 Oil" in Fig. A-1 of the Appendix. However, at  $100^\circ\text{C}$ , the value 0.0095 is within the range specified by SAE for this oil:  $9.3 < \nu < 12.5 \text{ mm}^2/\text{s}$ , if its density lies in the range  $760 < \rho < 1020 \text{ kg/m}^3$ , which it surely must. Therefore a surprisingly wide difference in viscosity-versus-temperature still makes an oil "SAE 30." To fit Andrade's law,  $\mu \approx A \exp(B/T)$ , we must make a least-squares fit for the 6 data points above (just as we did in Prob. 1.41):

$$\text{Andrade fit: With } E = \sum_{i=1}^6 \left[ \mu_i - A \exp\left(\frac{B}{T_i}\right) \right]^2, \quad \text{then set } \frac{\partial E}{\partial A} = 0 \quad \text{and} \quad \frac{\partial E}{\partial B} = 0$$

This formulation produces the following results:

$$\text{Least-squares of } \mu \text{ versus } T: \quad \mu \approx 2.35\text{E-10} \frac{\text{kg}}{\text{m}\cdot\text{s}} \exp\left(\frac{6245 \text{ K}}{T^\circ\text{K}}\right) \quad \text{Ans. (\#1)}$$



These results (#1) are pretty *terrible*, errors of  $\pm 50\%$ , even though they are “least-squares.” The reason is that  $\mu$  varies over three orders of magnitude, so the fit is biased to *higher*  $\mu$ .

An alternate fit to Andrade’s equation would be to plot  $\ln(\mu)$  versus  $1/T$  ( $^{\circ}\text{K}$ ) on, say, “Cricket Graph,” and then fit the resulting near straight line by least squares. The result is:

$$\text{Least-squares of } \ln(\mu) \text{ versus } \frac{1}{T}: \quad \mu \approx 3.31\text{E-}9 \frac{\text{kg}}{\text{m}\cdot\text{s}} \exp\left(\frac{5476 \text{ K}}{T^{\circ}\text{K}}\right) \quad \text{Ans. (\#2)}$$

The accuracy is somewhat better, but not great, as follows:

T, $^{\circ}\text{C}$ :	0	20	40	60	80	100
$\mu_{\text{SAE30}}$ , $\text{kg/m}\cdot\text{s}$ :	2.00	0.40	0.11	0.042	0.017	0.0095
Curve-fit #1:	2.00	0.42	0.108	0.033	0.011	0.0044
Curve-fit #2:	1.68	0.43	0.13	0.046	0.018	0.0078

Neither fit is worth writing home about. Andrade’s equation is not accurate for SAE 30 oil.

**1.45** A block of weight  $W$  slides down an inclined plane on a thin film of oil, as in Fig. P1.45 at right. The film contact area is  $A$  and its thickness  $h$ . Assuming a linear velocity distribution in the film, derive an analytic expression for the terminal velocity  $V$  of the block.

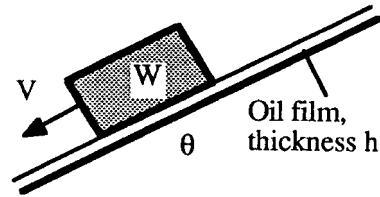


Fig. P1.45

**Solution:** Let “ $x$ ” be down the incline, in the direction of  $V$ . By “terminal” velocity we mean that there is no acceleration. Assume a linear viscous velocity distribution in the film below the block. Then a force balance in the  $x$  direction gives:

$$\sum F_x = W \sin \theta - \tau A = W \sin \theta - \left( \mu \frac{V}{h} \right) A = m a_x = 0,$$

$$\text{or: } V_{\text{terminal}} = \frac{hW \sin \theta}{\mu A} \quad \text{Ans.}$$

**1.46** Find the terminal velocity in Prob. P1.45 if  $m = 6 \text{ kg}$ ,  $A = 35 \text{ cm}^2$ ,  $\theta = 15^{\circ}$ , and the film is 1-mm thick SAE 30 oil at  $20^{\circ}\text{C}$ .

**Solution:** From Table A-3 for SAE 30 oil,  $\mu \approx 0.29 \text{ kg/m} \cdot \text{s}$ . We simply substitute these values into the analytical formula derived in Prob. 1.45:

$$V = \frac{hW \sin \theta}{\mu A} = \frac{(0.001 \text{ m})(6 \times 9.81 \text{ N}) \sin(15^\circ)}{(0.29 \text{ kg/m} \cdot \text{s})(0.0035 \text{ m}^2)} \approx \mathbf{15 \frac{m}{s}} \quad \text{Ans.}$$

**1.47** A shaft 6.00 cm in diameter and 40 cm long is pulled steadily at  $V = 0.4 \text{ m/s}$  through a sleeve 6.02 cm in diameter. The clearance is filled with oil,  $\nu = 0.003 \text{ m}^2/\text{s}$  and  $\text{SG} = 0.88$ . Estimate the force required to pull the shaft.

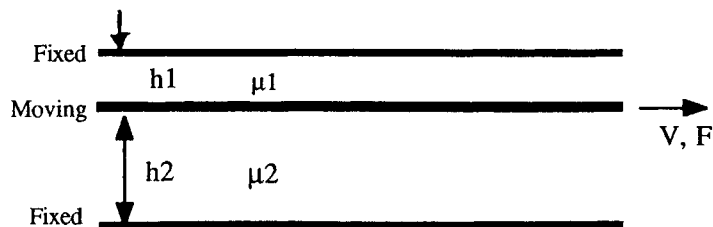
**Solution:** Assuming a linear velocity distribution in the clearance, the force is balanced by resisting shear stress in the oil:

$$F = \tau A_{\text{wall}} = \left( \mu \frac{V}{\Delta R} \right) (\pi D_i L) = \frac{\mu V \pi D_i L}{R_o - R_i}$$

For the given oil,  $\mu = \rho \nu = (0.88 \times 998 \text{ kg/m}^3)(0.003 \text{ m}^2/\text{s}) \approx 2.63 \text{ N} \cdot \text{s/m}$  (or  $\text{kg/m} \cdot \text{s}$ ). Then we substitute the given numerical values to obtain the force:

$$F = \frac{\mu V \pi D_i L}{R_o - R_i} = \frac{(2.63 \text{ N} \cdot \text{s/m}^2)(0.4 \text{ m/s})\pi(0.06 \text{ m})(0.4 \text{ m})}{(0.0301 - 0.0300 \text{ m})} \approx \mathbf{795 \text{ N}} \quad \text{Ans.}$$

**1.48** A thin moving plate is separated from two fixed plates by two fluids of unequal viscosity and unequal spacing, as shown below. The contact area is  $A$ . Determine (a) the force required, and (b) is there a necessary relation between the two viscosity values?



**Solution:** (a) Assuming a linear velocity distribution on each side of the plate, we obtain

$$F = \tau_1 A + \tau_2 A = \left( \frac{\mu_1 V}{h_1} + \frac{\mu_2 V}{h_2} \right) A \quad \text{Ans. (a)}$$

The formula is of course valid only for laminar (nonturbulent) steady viscous flow.

(b) Since the center plate separates the two fluids, they may have separate, unrelated shear stresses, and there is *no necessary relation* between the two viscosities.

**1.49** An amazing number of commercial and laboratory devices have been developed to measure fluid viscosity, as described in Ref. 27. Consider a concentric shaft, as in Prob. 1.47, but now fixed axially and rotated inside the sleeve. Let the inner and outer cylinders have radii  $r_i$  and  $r_o$ , respectively, with total sleeve length  $L$ . Let the rotational rate be  $\Omega$  (rad/s) and the applied torque be  $M$ . Using these parameters, derive a theoretical relation for the viscosity  $\mu$  of the fluid between the cylinders.

**Solution:** Assuming a linear velocity distribution in the annular clearance, the shear stress is

$$\tau = \mu \frac{\Delta V}{\Delta r} \approx \mu \frac{\Omega r_i}{r_o - r_i}$$

This stress causes a force  $dF = \tau dA = \tau(r_i d\theta)L$  on each element of surface area of the inner shaft. The moment of this force about the shaft axis is  $dM = r_i dF$ . Put all this together:

$$M = \int r_i dF = \int_0^{2\pi} r_i \mu \frac{\Omega r_i}{r_o - r_i} r_i L d\theta = \frac{2\pi\mu\Omega r_i^3 L}{r_o - r_i}$$

$$\text{Solve for the viscosity: } \mu \approx M(r_o - r_i) / \{2\pi\Omega r_i^3 L\} \quad \text{Ans.}$$

**1.50** A simple viscometer measures the time  $t$  for a solid sphere to fall a distance  $L$  through a test fluid of density  $\rho$ . The fluid viscosity  $\mu$  is then given by

$$\mu \approx \frac{W_{\text{net}} t}{3\pi DL} \quad \text{if } t \geq \frac{2\rho DL}{\mu}$$

where  $D$  is the sphere diameter and  $W_{\text{net}}$  is the sphere net weight in the fluid.

(a) Show that both of these formulas are dimensionally homogeneous. (b) Suppose that a 2.5 mm diameter aluminum sphere (density 2700 kg/m<sup>3</sup>) falls in an oil of density 875 kg/m<sup>3</sup>. If the time to fall 50 cm is 32 s, estimate the oil viscosity and verify that the inequality is valid.

**Solution:** (a) Test the dimensions of each term in the two equations:

$$\{\mu\} = \left\{ \frac{M}{LT} \right\} \quad \text{and} \quad \left\{ \frac{W_{\text{net}} t}{(3\pi)DL} \right\} = \left\{ \frac{(ML/T^2)(T)}{(1)(L)(L)} \right\} = \left\{ \frac{M}{LT} \right\} \quad \text{Yes, dimensions OK.}$$

$$\{t\} = \{T\} \quad \text{and} \quad \left\{ \frac{2\rho DL}{\mu} \right\} = \left\{ \frac{(1)(M/L^3)(L)(L)}{M/LT} \right\} = \{T\} \quad \text{Yes, dimensions OK.} \quad \text{Ans. (a)}$$

(b) Evaluate the two equations for the data. We need the net weight of the sphere in the fluid:

$$W_{\text{net}} = (\rho_{\text{sphere}} - \rho_{\text{fluid}})g(\text{Vol})_{\text{fluid}} = (2700 - 875 \text{ kg/m}^3)(9.81 \text{ m/s}^2)(\pi/6)(0.0025 \text{ m})^3 \\ = 0.000146 \text{ N}$$

$$\text{Then } \mu = \frac{W_{\text{net}}t}{3\pi DL} = \frac{(0.000146 \text{ N})(32 \text{ s})}{3\pi(0.0025 \text{ m})(0.5 \text{ m})} = \mathbf{0.40} \frac{\text{kg}}{\text{m} \cdot \text{s}} \quad \text{Ans. (b)}$$

$$\text{Check } t = 32 \text{ s compared to } \frac{2\rho DL}{\mu} = \frac{2(875 \text{ kg/m}^3)(0.0025 \text{ m})(0.5 \text{ m})}{0.40 \text{ kg/m} \cdot \text{s}} \\ = 5.5 \text{ s OK, } t \text{ is greater}$$

**1.51** Use the theory of Prob. 1.50 for a shaft 8 cm long, rotating at 1200 r/min, with  $r_i = 2.00$  cm and  $r_o = 2.05$  cm. The measured torque is  $M = 0.293$  N·m. What is the fluid viscosity? If the experimental uncertainties are:  $L$  ( $\pm 0.5$  mm),  $M$  ( $\pm 0.003$  N·m),  $\Omega$  ( $\pm 1\%$ ), and  $r_i$  and  $r_o$  ( $\pm 0.02$  mm), what is the uncertainty in the *viscosity* determination?

**Solution:** First change the rotation rate to  $\Omega = (2\pi/60)(1200) = 125.7$  rad/s. Then the analytical expression derived in Prob. 1.50 directly above is

$$\mu = \frac{M(R_o - R_i)}{2\pi\Omega R_i^3 L} = \frac{(0.293 \text{ N} \cdot \text{m})(0.0205 - 0.0200 \text{ m})}{2\pi \left(125.7 \frac{\text{rad}}{\text{s}}\right) (0.02 \text{ m})^3 (0.08 \text{ m})} \approx \mathbf{0.29} \frac{\text{kg}}{\text{m} \cdot \text{s}} \quad \text{Ans.}$$

It might be SAE 30W oil! For estimating overall uncertainty, since the formula involves five things, the total uncertainty is a combination of errors, each expressed as a fraction:

$$S_M = \frac{0.003}{0.293} = 0.0102; \quad S_{\Delta R} = \frac{0.04}{0.5} = 0.08; \quad S_{\Omega} = 0.01$$

$$S_{R^3} = 3S_R = 3\left(\frac{0.02}{20}\right) = 0.003; \quad S_L = \frac{0.5}{80} = 0.00625$$

One might dispute the error in  $\Delta R$ —here we took it to be the sum of the two ( $\pm 0.02$ -mm) errors. The overall uncertainty is then expressed as an *rms* computation [Refs. 30 and 31 of Chap. 1]:

$$S_{\mu} = \sqrt{(S_M^2 + S_{\Delta R}^2 + S_{\Omega}^2 + S_{R^3}^2 + S_L^2)} \\ = [(0.0102)^2 + (0.08)^2 + (0.01)^2 + (0.003)^2 + (0.00625)^2] \approx \mathbf{0.082} \quad \text{Ans.}$$

The total error is dominated by the 8% error in the estimate of clearance,  $(R_o - R_i)$ . We might state the experimental result for viscosity as

$$\mu_{\text{exp}} \approx 0.29 \pm 8.2\% = \mathbf{0.29 \pm 0.024} \frac{\text{kg}}{\text{m} \cdot \text{s}} \quad \text{Ans.}$$

**1.52** The belt in Fig. P1.52 moves at steady velocity  $V$  and skims the top of a tank of oil of viscosity  $\mu$ . Assuming a linear velocity profile, develop a simple formula for the belt-drive power  $P$  required as a function of  $(h, L, V, B, \mu)$ . Neglect air drag. What power  $P$  in watts is required if the belt moves at 2.5 m/s over SAE 30W oil at 20°C, with  $L = 2$  m,  $b = 60$  cm, and  $h = 3$  cm?

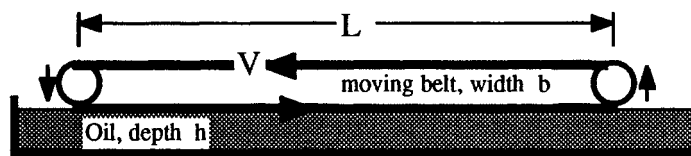


Fig. P1.52

**Solution:** The power is the viscous resisting force times the belt velocity:

$$P = \tau_{\text{oil}} A_{\text{belt}} V_{\text{belt}} \approx \left( \mu \frac{V}{h} \right) (bL)V = \mu V^2 b \frac{L}{h} \quad \text{Ans.}$$

(b) For SAE 30W oil,  $\mu \approx 0.29$  kg/m·s. Then, for the given belt parameters,

$$P = \mu V^2 b L / h = \left( 0.29 \frac{\text{kg}}{\text{m} \cdot \text{s}} \right) \left( 2.5 \frac{\text{m}}{\text{s}} \right)^2 (0.6 \text{ m}) \frac{2.0 \text{ m}}{0.03 \text{ m}} \approx 73 \frac{\text{kg} \cdot \text{m}^2}{\text{s}^3} = \mathbf{73 \text{ W}} \quad \text{Ans. (b)}$$

**1.53\*** A solid cone of base  $r_o$  and initial angular velocity  $\omega_o$  is rotating inside a conical seat. Neglect air drag and derive a formula for the cone's angular velocity  $\omega(t)$  if there is no applied torque.

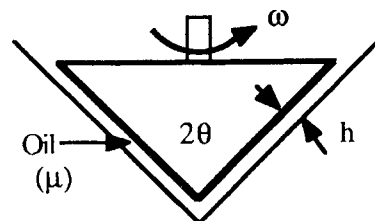


Fig. P1.53

**Solution:** At any radial position  $r < r_o$  on the cone surface and instantaneous rate  $\omega$ ,

$$d(\text{Torque}) = r \tau dA_w = r \left( \mu \frac{r \omega}{h} \right) \left( 2\pi r \frac{dr}{\sin \theta} \right),$$

$$\text{or: Torque } M = \int_0^{r_0} \frac{\mu\omega}{h \sin\theta} 2\pi r^3 dr = \frac{\pi\mu\omega r_0^4}{2h \sin\theta}$$

We may compute the cone's slowing down from the angular momentum relation:

$$M = -I_o \frac{d\omega}{dt}, \quad \text{where } I_o(\text{cone}) = \frac{3}{10} m r_0^2, \quad m = \text{cone mass}$$

Separating the variables, we may integrate:

$$\int_{\omega_0}^{\omega} \frac{d\omega}{\omega} = -\frac{\pi\mu r_0^4}{2h I_o \sin\theta} \int_0^t dt, \quad \text{or: } \omega = \omega_0 \exp\left[-\frac{5\pi\mu r_0^2 t}{3mh \sin\theta}\right] \quad \text{Ans.}$$

**1.54\*** A disk of radius  $R$  rotates at angular velocity  $\Omega$  inside an oil container of viscosity  $\mu$ , as in Fig. P1.54. Assuming a linear velocity profile and neglecting shear on the outer disk edges, derive an expression for the viscous torque on the disk.

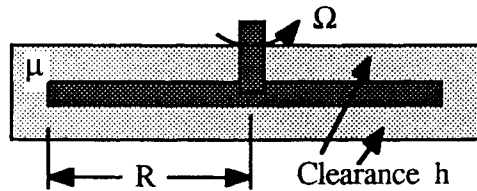


Fig. P1.54

**Solution:** At any  $r \leq R$ , the viscous shear  $\tau \approx \mu\Omega r/h$  on both sides of the disk. Thus,

$$d(\text{torque}) = dM = 2r\tau dA_w = 2r \frac{\mu\Omega r}{h} 2\pi r dr,$$

$$\text{or: } M = 4\pi \frac{\mu\Omega}{h} \int_0^R r^3 dr = \frac{\pi\mu\Omega R^4}{h} \quad \text{Ans.}$$

**1.55** Apply the *rotating-disk viscometer* of Prob. 1.54, to the particular case  $R = 5$  cm,  $h = 1$  mm, rotation rate 900 rev/min, measured torque  $M = 0.537$  N·m. What is the fluid viscosity? If each parameter ( $M, R, h, \Omega$ ) has uncertainty of  $\pm 1\%$ , what is the overall uncertainty of the measured viscosity?

**Solution:** The analytical formula  $M = \pi\mu\Omega R^4/h$  was derived in Prob. 1.54. Convert the rotation rate to rad/s:  $\Omega = (900 \text{ rev/min})(2\pi \text{ rad/rev} \div 60 \text{ s/min}) = 94.25 \text{ rad/s}$ . Then,

$$\mu = \frac{hM}{\pi\Omega R^4} = \frac{(0.001 \text{ m})(0.537 \text{ N}\cdot\text{m})}{\pi(94.25 \text{ rad/s})(0.05 \text{ m})^4} = \mathbf{0.29} \frac{\text{N}\cdot\text{s}}{\text{m}^2} \left( \text{or } \frac{\text{kg}}{\text{m}\cdot\text{s}} \right) \quad \text{Ans.}$$

For uncertainty, looking at the formula for  $\mu$ , we have first powers in  $h$ ,  $M$ , and  $\Omega$  and a fourth power in  $R$ . The overall uncertainty estimate [see Eq. (1.44) and Ref. 31] would be

$$S_\mu \approx \left[ S_h^2 + S_M^2 + S_\Omega^2 + (4S_R)^2 \right]^{1/2} \\ \approx [(0.01)^2 + (0.01)^2 + (0.01)^2 + \{4(0.01)\}^2]^{1/2} \approx 0.044 \quad \text{or: } \pm 4.4\% \quad \text{Ans.}$$

The uncertainty is dominated by the 4% error due to radius measurement. We might report the measured viscosity as  $\mu \approx 0.29 \pm 4.4\%$  kg/m·s or  $0.29 \pm 0.013$  kg/m·s.

**1.56\*** For the cone-plate viscometer in Fig. P1.56, the angle is very small, and the gap is filled with test liquid  $\mu$ . Assuming a linear velocity profile, derive a formula for the viscosity  $\mu$  in terms of the torque  $M$  and cone parameters.

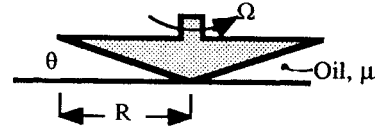


Fig. P1.56

**Solution:** For any radius  $r \leq R$ , the liquid gap is  $h = r \tan \theta$ . Then

$$d(\text{Torque}) = dM = \tau dA_w r = \left( \mu \frac{\Omega r}{r \tan \theta} \right) \left( 2\pi r \frac{dr}{\cos \theta} \right) r, \quad \text{or} \\ M = \frac{2\pi\Omega\mu}{\sin \theta} \int_0^R r^2 dr = \frac{2\pi\Omega\mu R^3}{3 \sin \theta}, \quad \text{or: } \mu = \frac{3M \sin \theta}{2\pi\Omega R^3} \quad \text{Ans.}$$

**1.57** Apply the cone-plate viscometer of Prob. 1.56 above to the special case  $R = 6$  cm,  $\theta = 3^\circ$ ,  $M = 0.157$  N·m, and a rotation rate of 600 rev/min. What is the fluid viscosity? If each parameter ( $M, R, \Omega, \theta$ ) has an uncertainty of  $\pm 1\%$ , what is the uncertainty of  $\mu$ ?

**Solution:** We derived a suitable linear-velocity-profile formula in Prob. 1.56. Convert the rotation rate to rad/s:  $\Omega = (600 \text{ rev/min})(2\pi \text{ rad/rev} \div 60 \text{ s/min}) = 62.83 \text{ rad/s}$ . Then,

$$\mu = \frac{3M \sin \theta}{2\pi\Omega R^3} = \frac{3(0.157 \text{ N}\cdot\text{m}) \sin(3^\circ)}{2\pi(62.83 \text{ rad/s})(0.06 \text{ m})^3} = 0.29 \frac{\text{N}\cdot\text{s}}{\text{m}^2} \quad \left( \text{or } \frac{\text{kg}}{\text{m}\cdot\text{s}} \right) \quad \text{Ans.}$$

For uncertainty, looking at the formula for  $\mu$ , we have first powers in  $\theta$ ,  $M$ , and  $\Omega$  and a third power in  $R$ . The overall uncertainty estimate [see Eq. (1.44) and Ref. 31] would be

$$S_\mu = \left[ S_\theta^2 + S_M^2 + S_\Omega^2 + (3S_R)^2 \right]^{1/2} \\ \approx [(0.01)^2 + (0.01)^2 + (0.01)^2 + \{3(0.01)\}^2]^{1/2} = 0.035, \quad \text{or: } \pm 3.5\% \quad \text{Ans.}$$

The uncertainty is dominated by the 3% error due to radius measurement. We might report the measured viscosity as  $\mu \approx 0.29 \pm 3.5\%$  kg/m·s or  $0.29 \pm 0.01$  kg/m·s.

**1.58** The laminar-pipe-flow example of Prob. 1.14 leads to a *capillary viscometer* [27], using the formula  $\mu = \pi r_o^4 \Delta p / (8LQ)$ . Given  $r_o = 2$  mm and  $L = 25$  cm. The data are

Q, m <sup>3</sup> /hr:	0.36	0.72	1.08	1.44	1.80
$\Delta p$ , kPa:	159	318	477	1274	1851

Estimate the fluid viscosity. What is wrong with the last two data points?

**Solution:** Apply our formula, with consistent units, to the first data point:

$$\Delta p = 159 \text{ kPa: } \mu \approx \frac{\pi r_o^4 \Delta p}{8LQ} = \frac{\pi (0.002 \text{ m})^4 (159000 \text{ N/m}^2)}{8(0.25 \text{ m})(0.36/3600 \text{ m}^3/\text{s})} \approx 0.040 \frac{\text{N} \cdot \text{s}}{\text{m}^2}$$

Do the same thing for all five data points:

$\Delta p$ , kPa:	159	318	477	1274	1851
$\mu$ , N·s/m <sup>2</sup> :	<b>0.040</b>	<b>0.040</b>	<b>0.040</b>	0.080(?)	0.093(?) <i>Ans.</i>

The last two estimates, though measured properly, are *incorrect*. The Reynolds number of the capillary has risen above 2000 and the flow is turbulent, which requires a different formula.

**1.59** A solid cylinder of diameter  $D$ , length  $L$ , density  $\rho_s$  falls due to gravity inside a tube of diameter  $D_o$ . The clearance,  $(D_o - D) \ll D$ , is filled with a film of viscous fluid ( $\rho, \mu$ ). Derive a formula for terminal fall velocity and apply to SAE 30 oil at 20°C for a steel cylinder with  $D = 2$  cm,  $D_o = 2.04$  cm, and  $L = 15$  cm. Neglect the effect of any air in the tube.

**Solution:** The geometry is similar to Prob. 1.47, only vertical instead of horizontal. At terminal velocity, the cylinder weight should equal the viscous drag:

$$a_z = 0: \quad \Sigma F_z = -W + \text{Drag} = -\rho_s g \frac{\pi}{4} D^2 L + \left[ \mu \frac{V}{(D_o - D)/2} \right] \pi DL,$$

$$\text{or: } V = \frac{\rho_s g D (D_o - D)}{8\mu} \quad \text{Ans.}$$

For the particular numerical case given,  $\rho_{\text{steel}} \approx 7850 \text{ kg/m}^3$ . For SAE 30 oil at 20°C,  $\mu \approx 0.29 \text{ kg/m} \cdot \text{s}$  from Table 1.4. Then the formula predicts

$$V_{\text{terminal}} = \frac{\rho_s g D (D_o - D)}{8\mu} = \frac{(7850 \text{ kg/m}^3)(9.81 \text{ m/s}^2)(0.02 \text{ m})(0.0204 - 0.02 \text{ m})}{8(0.29 \text{ kg/m} \cdot \text{s})}$$

$$\approx \mathbf{0.265 \text{ m/s}} \quad \text{Ans.}$$



**1.60** A highly viscous (non-turbulent) fluid fills the gap between two long concentric cylinders of radii  $a$  and  $b > a$ , respectively. If the outer cylinder is fixed and the inner cylinder moves steadily at axial velocity  $U$ , the fluid will move at the axial velocity:

$$v_z = \frac{U \ln(b/r)}{\ln(b/a)}$$

See Fig. 4.2 for a definition of the velocity component  $v_z$ . Sketch this velocity distribution between the cylinders and comment. Find expressions for the shear stresses at both the inner and outer cylinder surfaces and explain why they are different.

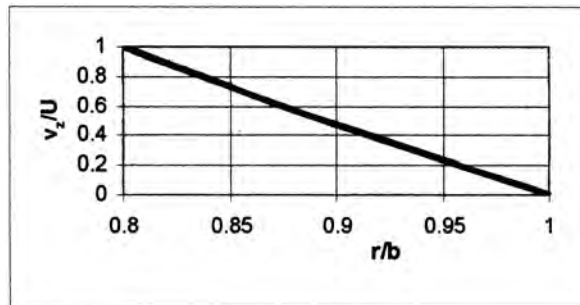
**Solution:** Evaluate the shear stress at each cylinder by the Newtonian law, Eq. (1.23):

$$\tau_{\text{inner}} = \mu \frac{d}{dr} \left[ \frac{U \ln(b/r)}{\ln(b/a)} \right] = \frac{\mu U}{\ln(b/a)} \left( \frac{1}{r} \right)_{r=a} = \frac{\mu U}{a \ln(b/a)} \quad \text{Ans.}$$

$$\tau_{\text{outer}} = \mu \frac{d}{dr} \left[ \frac{U \ln(b/r)}{\ln(b/a)} \right] = \frac{\mu U}{\ln(b/a)} \left( \frac{1}{r} \right)_{r=b} = \frac{\mu U}{b \ln(b/a)} \quad \text{Ans.}$$

They are *not* the same because the outer cylinder area is larger. For equilibrium, we need the inner and outer axial forces to be the same, which means  $\tau_{\text{inner}}a = \tau_{\text{outer}}b$ .

A sketch of  $v_z(r)$ , from the logarithmic formula above, is shown for a relatively wide annulus,  $a/b = 0.8$ . The velocity profile is seen to be nearly linear.



**1.61** An air-hockey puck has  $m = 50$  g and  $D = 9$  cm. When placed on a  $20^\circ\text{C}$  air table, the blower forms a 0.12-mm-thick air film under the puck. The puck is struck with an initial velocity of 10 m/s. How long will it take the puck to (a) slow down to 1 m/s; (b) stop completely? Also (c) how far will the puck have travelled for case (a)?

**Solution:** For air at  $20^\circ\text{C}$  take  $\mu \approx 1.8\text{E}-5$  kg/m·s. Let  $A$  be the bottom area of the puck,  $A = \pi D^2/4$ . Let  $x$  be in the direction of travel. Then the only force acting in the

$x$  direction is the air drag resisting the motion, assuming a linear velocity distribution in the air:

$$\sum F_x = -\tau A = -\mu \frac{V}{h} A = m \frac{dV}{dt}, \quad \text{where } h = \text{air film thickness}$$

Separate the variables and integrate to find the velocity of the decelerating puck:

$$\int_{V_0}^V \frac{dV}{V} = -K \int_0^t dt, \quad \text{or} \quad V = V_0 e^{-Kt}, \quad \text{where } K = \frac{\mu A}{mh}$$

Integrate again to find the displacement of the puck:

$$x = \int_0^t V dt = \frac{V_0}{K} [1 - e^{-Kt}]$$

Apply to the particular case given: air,  $\mu \approx 1.8E-5$  kg/m·s,  $m = 50$  g,  $D = 9$  cm,  $h = 0.12$  mm,  $V_0 = 10$  m/s. First evaluate the time-constant  $K$ :

$$K = \frac{\mu A}{mh} = \frac{(1.8E-5 \text{ kg/m} \cdot \text{s})[(\pi/4)(0.09 \text{ m})^2]}{(0.050 \text{ kg})(0.00012 \text{ m})} \approx 0.0191 \text{ s}^{-1}$$

(a) When the puck slows down to 1 m/s, we obtain the time:

$$V = 1 \text{ m/s} = V_0 e^{-Kt} = (10 \text{ m/s}) e^{-(0.0191 \text{ s}^{-1})t}, \quad \text{or} \quad t \approx \mathbf{121 \text{ s}} \quad \text{Ans. (a)}$$

(b) The puck will stop completely only when  $e^{-Kt} = 0$ , or:  $t = \infty$  Ans. (b)

(c) For part (a), the puck will have travelled, in 121 seconds,

$$x = \frac{V_0}{K} (1 - e^{-Kt}) = \frac{10 \text{ m/s}}{0.0191 \text{ s}^{-1}} [1 - e^{-(0.0191)(121)}] \approx \mathbf{472 \text{ m}} \quad \text{Ans. (c)}$$

This may perhaps be a little unrealistic. But the air-hockey puck *does* accelerate slowly!

**1.62** The hydrogen bubbles in Fig. 1.13 have  $D \approx 0.01$  mm. Assume an “air-water” interface at 30°C. What is the excess pressure within the bubble?

**Solution:** At 30°C the surface tension from Table A-1 is 0.0712 N/m. For a droplet or bubble with one spherical surface, from Eq. (1.32),

$$\Delta p = \frac{2Y}{R} = \frac{2(0.0712 \text{ N/m})}{(5E-6 \text{ m})} \approx \mathbf{28500 \text{ Pa}} \quad \text{Ans.}$$

**1.63** Derive Eq. (1.37) by making a force balance on the fluid interface in Fig. 1.9c.

**Solution:** The surface tension forces  $YdL_1$  and  $YdL_2$  have a slight vertical component. Thus summation of forces in the vertical gives the result

$$\begin{aligned} \sum F_z = 0 &= 2YdL_2 \sin(d\theta_1/2) \\ &+ 2YdL_1 \sin(d\theta_2/2) - \Delta p dA \end{aligned}$$

But  $dA = dL_1 dL_2$  and  $\sin(d\theta/2) \approx d\theta/2$ , so we may solve for the pressure difference:

$$\Delta p = Y \frac{dL_2 d\theta_1 + dL_1 d\theta_2}{dL_1 dL_2} = Y \left( \frac{d\theta_1}{dL_1} + \frac{d\theta_2}{dL_2} \right) = Y \left( \frac{1}{R_1} + \frac{1}{R_2} \right) \quad \text{Ans.}$$

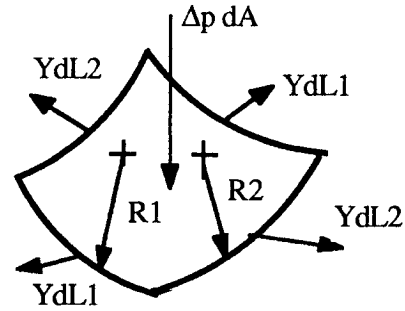


Fig. 1.9c

**1.64** A shower head emits a cylindrical jet of clean 20°C water into air. The pressure inside the jet is approximately 200 Pa greater than the air pressure. Estimate the jet diameter, in mm.

**Solution:** From Table A.5 the surface tension of water at 20°C is 0.0728 N/m. For a liquid cylinder, the internal excess pressure from Eq. (1.31) is  $\Delta p = Y/R$ . Thus, for our data,

$$\begin{aligned} \Delta p = Y/R &= 200 \text{ N/m}^2 = (0.0728 \text{ N/m})/R, \\ \text{solve } R &= 0.000364 \text{ m}, \quad D = \mathbf{0.00073 \text{ m}} \quad \text{Ans.} \end{aligned}$$

**1.65** The system in Fig. P1.65 is used to estimate the pressure  $p_1$  in the tank by measuring the 15-cm height of liquid in the 1-mm-diameter tube. The fluid is at 60°C. Calculate the true fluid height in the tube and the percent error due to capillarity if the fluid is (a) water; and (b) mercury.

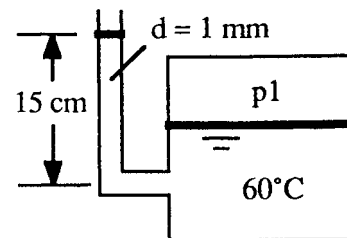


Fig. P1.65

**Solution:** This is a somewhat more realistic variation of Ex. 1.9. Use values from that example for contact angle  $\theta$ :

(a) Water at 60°C:  $\gamma \approx 9640 \text{ N/m}^3$ ,  $\theta \approx 0^\circ$ :

$$h = \frac{4Y \cos \theta}{\gamma D} = \frac{4(0.0662 \text{ N/m}) \cos(0^\circ)}{(9640 \text{ N/m}^3)(0.001 \text{ m})} = 0.0275 \text{ m},$$

or:  $\Delta h_{\text{true}} = 15.0 - 2.75 \text{ cm} \approx \mathbf{12.25 \text{ cm (+22\% error)}}$  Ans. (a)

(b) Mercury at 60°C:  $\gamma \approx 132200 \text{ N/m}^3$ ,  $\theta \approx 130^\circ$ :

$$h = \frac{4Y \cos \theta}{\gamma D} = \frac{4(0.47 \text{ N/m}) \cos 130^\circ}{(132200 \text{ N/m}^3)(0.001 \text{ m})} = -0.0091 \text{ m},$$

or:  $\Delta h_{\text{true}} = 15.0 + 0.91 \approx \mathbf{15.91 \text{ cm (-6\% error)}}$  Ans. (b)

**1.66** A thin wire ring, 3 cm in diameter, is lifted from a water surface at 20°C. What is the lift force required? Is this a good method? Suggest a ring material.

**Solution:** In the literature this ring-pull device is called a DuNouy Tensiometer. The forces are very small and may be measured by a calibrated soft-spring balance. Platinum-iridium is recommended for the ring, being noncorrosive and highly wetting to most liquids. There are two surfaces, inside and outside the ring, so the total force measured is

$$F = 2(Y\pi D) = 2Y\pi D$$

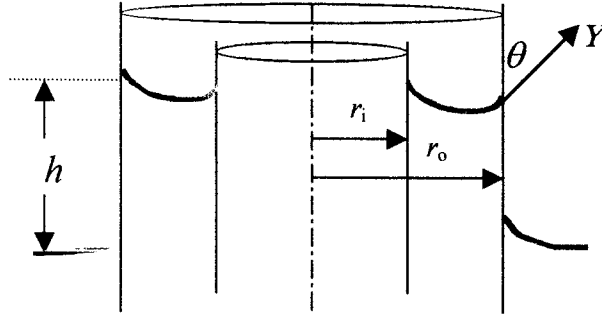
This is crude—commercial devices recommend multiplying this relation by a correction factor  $f = O(1)$  which accounts for wire diameter and the distorted surface shape.

For the given data,  $Y \approx 0.0728 \text{ N/m}$  (20°C water/air) and the estimated pull force is

$$F = 2\pi(0.0728 \text{ N/m})(0.03 \text{ m}) \approx \mathbf{0.0137 \text{ N}}$$
 Ans.

For further details, see, e.g., F. Daniels et al., *Experimental Physical Chemistry*, 7th ed., McGraw-Hill Book Co., New York, 1970.

**1.67** A vertical concentric annulus, with outer radius  $r_o$  and inner radius  $r_i$ , is lowered into fluid of surface tension  $Y$  and contact angle  $\theta < 90^\circ$ . Derive an expression for the capillary rise  $h$  in the annular gap, if the gap is very narrow.



**Solution:** For the figure above, the force balance on the annular fluid is

$$Y \cos \theta (2\pi r_o + 2\pi r_i) = \rho g \pi (r_o^2 - r_i^2) h$$

Cancel where possible and the result is

$$h = 2Y \cos \theta / \{\rho g (r_o - r_i)\} \quad \text{Ans.}$$

**1.68\*** Analyze the shape  $\eta(x)$  of the water-air interface near a wall, as shown. Assume small slope,  $R^{-1} \approx d^2\eta/dx^2$ . The pressure difference across the interface is  $\Delta p \approx \rho g \eta$ , with a contact angle  $\theta$  at  $x = 0$  and a horizontal surface at  $x = \infty$ . Find an expression for the maximum height  $h$ .

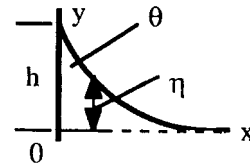


Fig. P1.68

**Solution:** This is a two-dimensional surface-tension problem, with single curvature. The surface tension rise is balanced by the weight of the film. Therefore the differential equation is

$$\Delta p = \rho g \eta = \frac{Y}{R} \approx Y \frac{d^2\eta}{dx^2} \quad \left( \frac{d\eta}{dx} \ll 1 \right)$$

This is a second-order differential equation with the well-known solution,

$$\eta = C_1 \exp[Kx] + C_2 \exp[-Kx], \quad K = \sqrt{(\rho g/Y)}$$

To keep  $\eta$  from going infinite as  $x = \infty$ , it must be that  $C_1 = 0$ . The constant  $C_2$  is found from the maximum height at the wall:

$$\eta_{x=0} = h = C_2 \exp(0), \quad \text{hence } C_2 = h$$

Meanwhile, the contact angle shown above must be such that,

$$\left. \frac{d\eta}{dx} \right|_{x=0} = -\cot(\theta) = -hK, \quad \text{thus } h = \frac{\cot \theta}{K}$$

The complete (small-slope) solution to this problem is:

$$\eta = h \exp[-(\rho g/Y)^{1/2} x], \quad \text{where } h = (Y/\rho g)^{1/2} \cot \theta \quad \text{Ans.}$$

The formula clearly satisfies the requirement that  $\eta = 0$  if  $x = \infty$ . It requires “small slope” and therefore the contact angle should be in the range  $70^\circ < \theta < 110^\circ$ .

**1.69** A solid cylindrical needle of diameter  $d$ , length  $L$ , and density  $\rho_n$  may “float” on a liquid surface. Neglect buoyancy and assume a contact angle of  $0^\circ$ . Calculate the maximum diameter needle able to float on the surface.

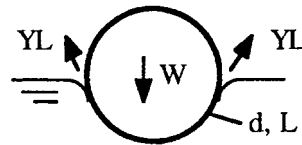


Fig. P1.69

**Solution:** The needle “dents” the surface downward and the surface tension forces are upward, as shown. If these tensions are nearly vertical, a vertical force balance gives:

$$\sum F_z = 0 = 2YL - \rho g \frac{\pi}{4} d^2 L, \quad \text{or: } d_{\max} \approx \sqrt{\frac{8Y}{\pi \rho g}} \quad \text{Ans. (a)}$$

(b) Calculate  $d_{\max}$  for a steel needle ( $SG \approx 7.84$ ) in water at  $20^\circ\text{C}$ . The formula becomes:

$$d_{\max} = \sqrt{\frac{8Y}{\pi \rho g}} = \sqrt{\frac{8(0.073 \text{ N/m})}{\pi(7.84 \times 998 \text{ kg/m}^3)(9.81 \text{ m/s}^2)}} \approx 0.00156 \text{ m} \approx \mathbf{1.6 \text{ mm}} \quad \text{Ans. (b)}$$

**1.70** Derive an expression for the capillary-height change  $h$ , as shown, for a fluid of surface tension  $Y$  and contact angle  $\theta$  between two parallel plates  $W$  apart. Evaluate  $h$  for water at  $20^\circ\text{C}$  if  $W = 0.5 \text{ mm}$ .

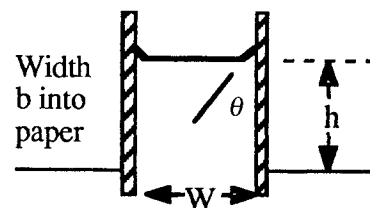


Fig. P1.70

**Solution:** With  $b$  the width of the plates into the paper, the capillary forces on each wall together balance the weight of water held above the reservoir free surface:

$$\rho g W h b = 2(Yb \cos \theta), \quad \text{or: } h \approx \frac{2Y \cos \theta}{\rho g W} \quad \text{Ans.}$$

For water at 20°C,  $Y \approx 0.0728 \text{ N/m}$ ,  $\rho g \approx 9790 \text{ N/m}^3$ , and  $\theta \approx 0^\circ$ . Thus, for  $W = 0.5 \text{ mm}$ ,

$$h = \frac{2(0.0728 \text{ N/m})\cos 0^\circ}{(9790 \text{ N/m}^3)(0.0005 \text{ m})} \approx 0.030 \text{ m} \approx \mathbf{30 \text{ mm}} \quad \text{Ans.}$$

**1.71\*** A soap bubble of diameter  $D_1$  coalesces with another bubble of diameter  $D_2$  to form a single bubble  $D_3$  with the same amount of air. For an isothermal process, express  $D_3$  as a function of  $D_1$ ,  $D_2$ ,  $p_{\text{atm}}$ , and surface tension  $Y$ .

**Solution:** The masses remain the same for an isothermal process of an ideal gas:

$$m_1 + m_2 = \rho_1 v_1 + \rho_2 v_2 = m_3 = \rho_3 v_3,$$

$$\text{or: } \left( \frac{p_a + 4Y/r_1}{RT} \right) \left( \frac{\pi}{6} D_1^3 \right) + \left( \frac{p_a + 4Y/r_2}{RT} \right) \left( \frac{\pi}{6} D_2^3 \right) = \left( \frac{p_a + 4Y/r_3}{RT} \right) \left( \frac{\pi}{6} D_3^3 \right)$$

The temperature cancels out, and we may clean up and rearrange as follows:

$$p_a D_3^3 + 8YD_3^2 = (p_a D_2^3 + 8YD_2^2) + (p_a D_1^3 + 8YD_1^2) \quad \text{Ans.}$$

This is a cubic polynomial with a known right hand side, to be solved for  $D_3$ .

**1.72** Early mountaineers boiled water to estimate their altitude. If they reach the top and find that water boils at 84°C, approximately how high is the mountain?

**Solution:** From Table A-5 at 84°C, vapor pressure  $p_v \approx 55.4 \text{ kPa}$ . We may use this value to interpolate in the standard altitude, Table A-6, to estimate

$$z \approx \mathbf{4800 \text{ m}} \quad \text{Ans.}$$

**1.73** A small submersible moves at velocity  $V$  in 20°C water at 2-m depth, where ambient pressure is 131 kPa. Its critical cavitation number is  $Ca \approx 0.25$ . At what velocity will cavitation bubbles form? Will the body cavitate if  $V = 30 \text{ m/s}$  and the water is cold (5°C)?

**Solution:** From Table A-5 at 20°C read  $p_v = 2.337 \text{ kPa}$ . By definition,

$$Ca_{\text{crit}} = 0.25 = \frac{2(p_a - p_v)}{\rho V^2} = \frac{2(131000 - 2337)}{(998 \text{ kg/m}^3)V^2}, \quad \text{solve } V_{\text{crit}} \approx \mathbf{32.1 \text{ m/s}} \quad \text{Ans. (a)}$$

If we decrease water temperature to 5°C, the vapor pressure reduces to 863 Pa, and the density changes slightly, to 1000 kg/m<sup>3</sup>. For this condition, if V = 30 m/s, we compute:

$$Ca = \frac{2(131000 - 863)}{(1000)(30)^2} \approx 0.289$$

This is *greater* than 0.25, therefore the body **will not cavitate for these conditions.** *Ans.* (b)

---

**1.74** A propeller is tested in a water tunnel at 20°C (similar to Fig. 1.12a). The lowest pressure on the body can be estimated by a Bernoulli-type relation,  $p_{\min} = p_o - \rho V^2/2$ , where  $p_o = 1.5$  atm and V is the tunnel average velocity. If V = 18 m/s, will there be cavitation? If so, can we change the water temperature and avoid cavitation?

**Solution:** At 20°C, from Table A-5,  $p_v = 2.337$  kPa. Compute the minimum pressure:

$$p_{\min} = p_o - \frac{1}{2} \rho V^2 = 1.5(101350 \text{ Pa}) - \frac{1}{2} \left( 998 \frac{\text{kg}}{\text{m}^3} \right) \left( 18 \frac{\text{m}}{\text{s}} \right)^2 = -9650 \text{ Pa} (??)$$

The predicted pressure is less than the vapor pressure, therefore the body **will cavitate.** [The actual pressure would not be negative; a cavitation bubble would form.]

Since the predicted pressure is negative; **no amount of cooling**—even to T = 0°C, where the vapor pressure is zero, will keep the body from cavitating at 18 m/s.

---

**1.75** Oil, with a vapor pressure of 20 kPa, is delivered through a pipeline by equally-spaced pumps, each of which increases the oil pressure by 1.3 MPa. Friction losses in the pipe are 150 Pa per meter of pipe. What is the maximum possible pump spacing to avoid cavitation of the oil?

**Solution:** The absolute maximum length L occurs when the pump inlet pressure is slightly greater than 20 kPa. The pump increases this by 1.3 MPa and friction drops the pressure over a distance L until it again reaches 20 kPa. In other words, quite simply,

$$1.3 \text{ MPa} = 1,300,000 \text{ Pa} = (150 \text{ Pa/m})L, \quad \text{or} \quad L_{\max} \approx \mathbf{8660 \text{ m}} \quad \text{Ans.}$$

It makes more sense to have the pump inlet at 1 atm, not 20 kPa, dropping L to about 8 km.

---

**1.76** Estimate the speed of sound of steam at 200°C and 400 kPa, (a) by an ideal-gas approximation (Table A.4); and (b) using EES (or the Steam Tables) and making small isentropic changes in pressure and density and approximating Eq. (1.38).



**Solution:** (a) For steam,  $k \approx 1.33$  and  $R = 461 \text{ m}^2/\text{s}^2 \cdot \text{K}$ . The ideal gas formula predicts:

$$a \approx \sqrt{(kRT)} = \sqrt{\{1.33(461 \text{ m}^2/\text{s}^2 \cdot \text{K})(200 + 273 \text{ K})\}} \approx \mathbf{539 \text{ m/s}} \quad \text{Ans. (a)}$$

(b) We use the formula  $a = \sqrt{(\partial p / \partial \rho)_s} \approx \sqrt{\{\Delta p|_s / \Delta \rho|_s\}}$  for small isentropic changes in  $p$  and  $\rho$ . From EES, at  $200^\circ\text{C}$  and  $400 \text{ kPa}$ , the entropy is  $s = 1.872 \text{ kJ/kg} \cdot \text{K}$ . Raise and lower the pressure  $1 \text{ kPa}$  at the same entropy. At  $p = 401 \text{ kPa}$ ,  $\rho = 1.87565 \text{ kg/m}^3$ . At  $p = 399 \text{ kPa}$ ,  $\rho = 1.86849 \text{ kg/m}^3$ . Thus  $\Delta \rho = 0.00716 \text{ kg/m}^3$ , and the formula for sound speed predicts:

$$a \approx \sqrt{\{\Delta p|_s / \Delta \rho|_s\}} = \sqrt{\{(2000 \text{ N/m}^2) / (0.00358 \text{ kg/m}^3)\}} = \mathbf{529 \text{ m/s}} \quad \text{Ans. (b)}$$

Again, as in Prob. 1.34, the ideal gas approximation is within 2% of a Steam-Table solution.

**1.77** The density of gasoline varies with pressure approximately as follows:

p, atm:	1	500	1000	1500
$\rho$ , lbm/ft <sup>3</sup> :	42.45	44.85	46.60	47.98

Estimate (a) its speed of sound, and (b) its bulk modulus at 1 atm.

**Solution:** For a crude estimate, we could just take differences of the first two points:

$$a \approx \sqrt{(\Delta p / \Delta \rho)} \approx \sqrt{\left\{ \frac{(500 - 1)(2116) \text{ lbf/ft}^2}{(44.85 - 42.45) / 32.2 \text{ slug/ft}^3} \right\}} \approx 3760 \frac{\text{ft}}{\text{s}} \approx \mathbf{1150 \frac{m}{s}} \quad \text{Ans. (a)}$$

$$B \approx \rho a^2 = [42.45 / 32.2 \text{ slug/ft}^3] (3760 \text{ ft/s})^2 \approx 1.87\text{E}7 \frac{\text{lbf}}{\text{ft}^2} \approx \mathbf{895 \text{ MPa}} \quad \text{Ans. (b)}$$

For more accuracy, we could fit the data to the nonlinear equation of state for liquids, Eq. (1.22). The best-fit result for gasoline (data above) is  $n \approx 8.0$  and  $B \approx 900$ .

Equation (1.22) is too simplified to show temperature or entropy effects, so we assume that it approximates “isentropic” conditions and thus differentiate:

$$\frac{p}{p_a} \approx (B + 1)(\rho / \rho_a)^n - B, \quad \text{or:} \quad a^2 = \frac{dp}{d\rho} \approx \frac{n(B + 1)p_a}{\rho_a} (\rho / \rho_a)^{n-1}$$

$$\text{or, at 1 atm, } a_{\text{liquid}} \approx \sqrt{n(B + 1)p_a / \rho_a}$$

The bulk modulus of gasoline is thus approximately:

$$\text{“B”} = \rho \left. \frac{dp}{d\rho} \right|_{\text{1 atm}} = n(B + 1)p_a = (8.0)(901)(101350 \text{ Pa}) \approx \mathbf{731 \text{ MPa}} \quad \text{Ans. (b)}$$

And the speed of sound in gasoline is approximately,

$$a_{\text{atm}} = [(8.0)(901)(101350 \text{ Pa})/(680 \text{ kg/m}^3)]^{1/2} \approx \mathbf{1040 \frac{m}{s}} \quad \text{Ans. (a)}$$


---

**1.78** Sir Isaac Newton measured sound speed by timing the difference between seeing a cannon's puff of smoke and hearing its boom. If the cannon is on a mountain 5.2 miles away, estimate the air temperature in °C if the time difference is (a) 24.2 s; (b) 25.1 s.

**Solution:** Cannon booms are finite (shock) waves and travel slightly faster than sound waves, but what the heck, assume it's close enough to sound speed:

$$(a) \quad a \approx \frac{\Delta x}{\Delta t} = \frac{5.2(5280)(0.3048)}{24.2} = 345.8 \frac{\text{m}}{\text{s}} = \sqrt{1.4(287)T}, \quad T \approx 298 \text{ K} \approx \mathbf{25^\circ\text{C}} \quad \text{Ans. (a)}$$

$$(b) \quad a \approx \frac{\Delta x}{\Delta t} = \frac{5.2(5280)(0.3048)}{25.1} = 333.4 \frac{\text{m}}{\text{s}} = \sqrt{1.4(287)T}, \quad T \approx 277 \text{ K} \approx \mathbf{4^\circ\text{C}} \quad \text{Ans. (b)}$$


---

**1.79** Even a tiny amount of dissolved gas can drastically change the speed of sound of a gas-liquid mixture. By estimating the pressure-volume change of the mixture, Olson [40] gives the following approximate formula:

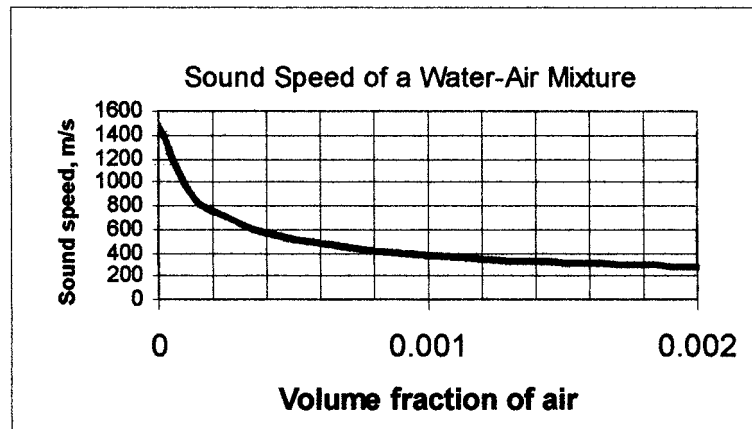
$$a_{\text{mixture}} \approx \sqrt{\frac{p_g K_l}{[x\rho_g + (1-x)\rho_l][xK_l + (1-x)p_g]}}$$

where  $x$  is the volume fraction of gas,  $K$  is the bulk modulus, and subscripts  $l$  and  $g$  denote the liquid and gas, respectively. (a) Show that the formula is dimensionally homogeneous. (b) For the special case of air bubbles (density  $1.7 \text{ kg/m}^3$  and pressure  $150 \text{ kPa}$ ) in water (density  $998 \text{ kg/m}^3$  and bulk modulus  $2.2 \text{ GPa}$ ), plot the mixture speed of sound in the range  $0 \leq x \leq 0.002$  and discuss.

**Solution:** (a) Since  $x$  is dimensionless and  $K$  dimensions cancel between the numerator and denominator, the remaining dimensions are pressure divided by density:

$$\{a_{\text{mixture}}\} = \left\{ \frac{[p]}{[\rho]} \right\}^{1/2} = \left\{ \frac{(\text{M}/\text{LT}^2)}{(\text{M}/\text{L}^3)} \right\}^{1/2} = [\text{L}^2/\text{T}^2]^{1/2} \\ = \mathbf{L/T} \quad \text{Yes, homogeneous} \quad \text{Ans. (a)}$$

(b) For the given data, a plot of sound speed versus gas volume fraction is as follows:



The difference in air and water compressibility is so great that the speed drop-off is quite sharp.

**1.80\*** A two-dimensional steady velocity field is given by  $u = x^2 - y^2$ ,  $v = -2xy$ . Find the streamline pattern and sketch a few lines. [*Hint*: The differential equation is exact.]

**Solution:** Equation (1.44) leads to the differential equation:

$$\frac{dx}{u} = \frac{dy}{v} = \frac{dx}{x^2 - y^2} = \frac{dy}{-2xy}, \quad \text{or: } (2xy)dx + (x^2 - y^2)dy = 0$$

As hinted, this equation is *exact*, that is, it has the form  $dF = (\partial F/\partial x)dx + (\partial F/\partial y)dy = 0$ . We may check this readily by noting that  $\partial/\partial y(2xy) = \partial/\partial x(x^2 - y^2) = 2x = \partial^2 F/\partial x \partial y$ . Thus we may integrate to give the formula for streamlines:

$$\mathbf{F} = \mathbf{x^2y - y^3/3 + constant} \quad \text{Ans.}$$

This represents (inviscid) flow in a series of  $60^\circ$  corners, as shown in Fig. E4.7a of the text. [This flow is also discussed at length in Section 4.7.]

**1.81** Repeat Ex. 1.13 by letting the velocity components increase linearly with time:

$$\mathbf{V} = Kxt\mathbf{i} - Kyt\mathbf{j} + 0\mathbf{k}$$

**Solution:** The flow is unsteady and two-dimensional, and Eq. (1.44) still holds:

$$\text{Streamline: } \frac{dx}{u} = \frac{dy}{v}, \quad \text{or: } \frac{dx}{Kxt} = \frac{dy}{-Kyt}$$

The terms  $K$  and  $t$  both vanish and leave us with the same result as in Ex. 1.13, that is,

$$\int dx/x = -\int dy/y, \quad \text{or: } \mathbf{xy = C} \quad \text{Ans.}$$

The streamlines have exactly the same “stagnation flow” shape as in Fig. 1.13. However, the flow *is* accelerating, and the mass flow between streamlines is constantly increasing.

**1.82** A velocity field is given by  $u = V \cos \theta$ ,  $v = V \sin \theta$ , and  $w = 0$ , where  $V$  and  $\theta$  are constants. Find an expression for the streamlines of this flow.

**Solution:** Equation (1.44) may be used to find the streamlines:

$$\frac{dx}{u} = \frac{dy}{v} = \frac{dx}{V \cos \theta} = \frac{dy}{V \sin \theta}, \quad \text{or: } \frac{dy}{dx} = \tan \theta$$

$$\text{Solution: } \mathbf{y = (\tan \theta)x + \text{constant}} \quad \text{Ans.}$$

The streamlines are straight parallel lines which make an angle  $\theta$  with the  $x$  axis. In other words, this velocity field represents a *uniform stream  $V$  moving upward at angle  $\theta$* .

**1.83\*** A two-dimensional *unsteady* velocity field is given by  $u = x(1 + 2t)$ ,  $v = y$ . Find the time-varying streamlines which pass through some reference point  $(x_0, y_0)$ . Sketch some.

**Solution:** Equation (1.44) applies with time as a parameter:

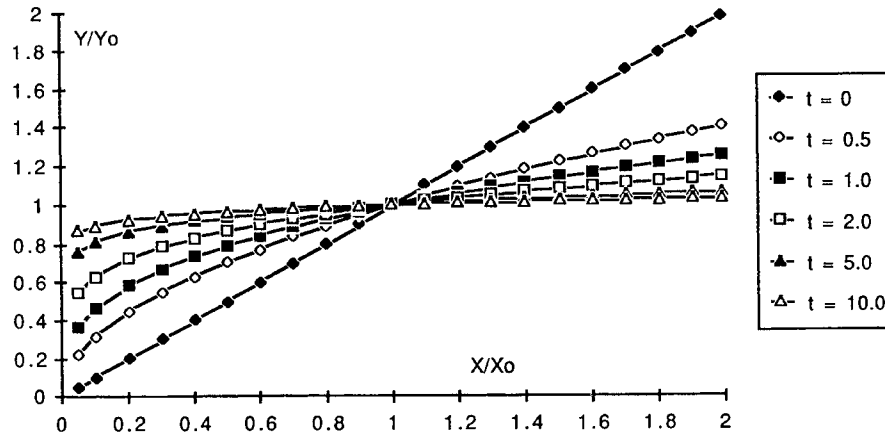
$$\frac{dx}{u} = \frac{dx}{x(1+2t)} = \frac{dy}{v} = \frac{dy}{y}, \quad \text{or: } \ln(y) = \frac{1}{1+2t} \ln(x) + \text{constant}$$

$$\text{or: } \mathbf{y = Cx^{1/(1+2t)}}, \quad \text{where } C \text{ is a constant}$$

In order for all streamlines to pass through  $y = y_0$  at  $x = x_0$ , the constant must be such that:

$$\mathbf{y = y_0 (x/x_0)^{1/(1+2t)}} \quad \text{Ans.}$$

Some streamlines are plotted on the next page and are seen to be strongly time-varying.



**1.84\*** Modify Prob. 1.83 to find the equation of the *pathline* which passes through the point  $(x_0, y_0)$  at  $t = 0$ . Sketch this pathline.

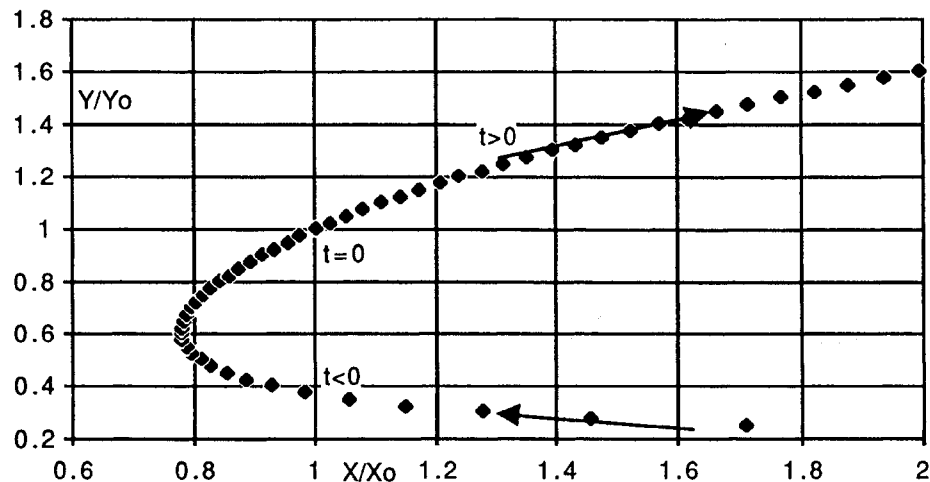
**Solution:** The pathline is computed by integration, over time, of the velocities:

$$\frac{dx}{dt} = u = x(1 + 2t), \quad \text{or:} \quad \int \frac{dx}{x} = \int (1 + 2t) dt, \quad \text{or:} \quad x = x_0 e^{t+2t^2}$$

$$\frac{dy}{dt} = v = y, \quad \text{or:} \quad \int \frac{dy}{y} = \int dt, \quad \text{or:} \quad y = y_0 e^t$$

We have implemented the initial conditions  $(x, y) = (x_0, y_0)$  at  $t = 0$ . [We were very lucky, as *planned* for this problem, that  $u$  did not depend upon  $y$  and  $v$  did not depend upon  $x$ .] Now eliminate  $t$  between these two to get a geometric expression for this particular pathline:

$$x = x_0 \exp\{\ln(y/y_0) + \ln^2(y/y_0)\} \quad \text{This pathline is shown in the sketch below.}$$



**1.85-a** Report to the class on the achievements of *Evangelista Torricelli*.

**Solution:** Torricelli's biography is taken from a goldmine of information which I did not put in the references, preferring to let the students find it themselves: C. C. Gillespie (ed.), *Dictionary of Scientific Biography*, 15 vols., Charles Scribner's Sons, New York, 1976.

Torricelli (1608–1647) was born in Faenza, Italy, to poor parents who recognized his genius and arranged through Jesuit priests to have him study mathematics, philosophy, and (later) hydraulic engineering under Benedetto Castelli. His work on dynamics of projectiles attracted the attention of Galileo himself, who took on Torricelli as an assistant in 1641. Galileo died one year later, and Torricelli was appointed in his place as “mathematician and philosopher” by Duke Ferdinando II of Tuscany. He then took up residence in Florence, where he spent his five happiest years, until his death in 1647. In 1644 he published his only known printed work, *Opera Geometrica*, which made him famous as a mathematician and geometer.

In addition to many contributions to geometry and calculus, Torricelli was the first to show that a zero-drag projectile formed a *parabolic* trajectory. His tables of trajectories for various angles and initial velocities were used by Italian artillerymen. He was an excellent machinist and constructed—and sold—the very finest telescope lenses in Italy.

Torricelli's hydraulic studies were brief but stunning, leading Ernst Mach to proclaim him the ‘founder of hydrodynamics.’ He deduced his theorem that the velocity of efflux from a hole in a tank was equal to  $\sqrt{2gh}$ , where  $h$  is the height of the free surface above the hole. He also showed that the efflux jet was parabolic and even commented on water-droplet breakup and the effect of air resistance. By experimenting with various liquids in closed tubes—including mercury (from mines in Tuscany)—he thereby invented the *barometer*. From barometric pressure (about 30 feet of water) he was able to explain why siphons did not work if the elevation change was too large. He also was the first to explain that winds were produced by temperature and *density differences* in the atmosphere and not by “evaporation.”

---

**1.85-b** Report to the class on the achievements of *Henri de Pitot*.

**Solution:** The following notes are abstracted from the *Dictionary of Scientific Biography* (see Prob. 1.85-a).

Pitot (1695–1771) was born in Aramon, France, to patrician parents. He hated to study and entered the military instead, but only for a short time. Chance reading of a textbook obtained in Grenoble led him back to academic studies of mathematics, astronomy, and engineering. In 1723 he became assistant to Réamur at the French Academy of Sciences and in 1740 became a civil engineer upon his appointment as a director of public works in Languedoc Province. He retired in 1756 and returned to Aramon until his death in 1771.

Pitot's research was apparently mediocre, described as “competent solutions to minor problems without lasting significance”—not a good recommendation for tenure nowadays! His *lasting* contribution was the invention, in 1735, of the instrument which

bears his name: a glass tube bent at right angles and inserted into a moving stream with the opening facing upstream. The water level in the tube rises a distance  $h$  above the surface, and Pitot correctly deduced that the stream velocity  $\approx \sqrt{2gh}$ . This is still a basic instrument in fluid mechanics.

---

**1.85-c** Report to the class on the achievements of *Antoine Chézy*.

**Solution:** The following notes are from Rouse and Ince [Ref. 23].

Chézy (1718–1798) was born in Châlons-sur-Marne, France, studied engineering at the Ecole des Ponts et Chaussées and then spent his entire career working for this school, finally being appointed Director one year before his death. His chief contribution was to study the flow in open channels and rivers, resulting in a famous formula, used even today, for the average velocity:

$$V \approx \text{const} \sqrt{AS/P}$$

where  $A$  is the cross-section area,  $S$  the bottom slope, and  $P$  the wetted perimeter, i.e., the length of the bottom and sides of the cross-section. The “constant” depends primarily on the roughness of the channel bottom and sides. [See Chap. 10 for further details.]

---

**1.85-d** Report to the class on the achievements of *Gotthilf Heinrich Ludwig Hagen*.

**Solution:** The following notes are from Rouse and Ince [Ref. 23].

Hagen (1884) was born in Königsberg, East Prussia, and studied there, having among his teachers the famous mathematician Bessel. He became an engineer, teacher, and writer and published a handbook on hydraulic engineering in 1841. He is best known for his study in 1839 of pipe-flow resistance, for water flow at heads of 0.7 to 40 cm, diameters of 2.5 to 6 mm, and lengths of 47 to 110 cm. The measurements indicated that the pressure drop was proportional to  $Q$  at low heads and proportional (approximately) to  $Q^2$  at higher heads, where “strong movements” occurred—turbulence. He also showed that  $\Delta p$  was approximately proportional to  $D^{-4}$ .

Later, in an 1854 paper, Hagen noted that the difference between laminar and turbulent flow was clearly visible in the efflux jet, which was either “smooth or fluctuating,” and in glass tubes, where sawdust particles either “moved axially” or, at higher  $Q$ , “came into whirling motion.” Thus Hagen was a true pioneer in fluid mechanics experimentation. Unfortunately, his achievements were somewhat overshadowed by the more widely publicized 1840 tube-flow studies of J. L. M. Poiseuille, the French physician.

---

**1.85-e** Report to the class on the achievements of *Julius Weisbach*.

**Solution:** The following notes are abstracted from the *Dictionary of Scientific Biography* (see Prob. 1.85-a) and also from Rouse and Ince [Ref. 23].

Weisbach (1806–1871) was born near Annaberg, Germany, the 8th of nine children of working-class parents. He studied mathematics, physics, and mechanics at Göttingen and Vienna and in 1831 became instructor of mathematics at Freiberg Gymnasium. In 1835 he was promoted to full professor at the Bergakademie in Freiberg. He published 15 books and 59 papers, primarily on hydraulics. He was a skilled laboratory worker and summarized his results in *Experimental-Hydraulik* (Freiberg, 1855) and in the *Lehrbuch der Ingenieur- und Maschinen-Mechanik* (Brunswick, 1845), which was still in print 60 years later. There were 13 chapters on hydraulics in this latter treatise. Weisbach modernized the subject of fluid mechanics, and his discussions and drawings of flow patterns would be welcome in any 20th century textbook—see Rouse and Ince [23] for examples.

Weisbach was the first to write the pipe-resistance head-loss formula in modern form:  $h_{f(\text{pipe})} = f(L/D)(V^2/2g)$ , where  $f$  was the dimensionless ‘friction factor,’ which Weisbach noted was not a constant but related to the pipe flow parameters [see Sect. 6.4]. He was also the first to derive the “weir equation” for volume flow rate  $Q$  over a dam of crest length  $L$ :

$$Q \approx \frac{2}{3} C_w (2g)^{1/2} \left[ \left( H + \frac{V^2}{2g} \right)^{3/2} - \left( \frac{V^2}{2g} \right)^{3/2} \right] \approx \frac{2}{3} C_w (2g)^{1/2} H^{3/2}$$

where  $H$  is the upstream water head level above the dam crest and  $C_w$  is a dimensionless weir coefficient  $\approx O(\text{unity})$ . [see Sect. 10.7] In 1860 Weisbach received the first Honorary Membership awarded by the German engineering society, the *Verein Deutscher Ingenieure*.

**1.85-f** Report to the class on the achievements of *George Gabriel Stokes*.

**Solution:** The following notes are abstracted from the *Dictionary of Scientific Biography* (see Prob. 1.85-a).

Stokes (1819–1903) was born in Skreen, County Sligo, Ireland, to a clerical family associated for generations with the Church of Ireland. He attended Bristol College and Cambridge University and, upon graduation in 1841, was elected Fellow of Pembroke College, Cambridge. In 1849, he became Lucasian Professor at Cambridge, a post once held by Isaac Newton. His 60-year career was spent primarily at Cambridge and resulted in many honors: President of the Cambridge Philosophical Society (1859), secretary (1854) and president (1885) of the Royal Society of London, member of Parliament (1887–1891), knighthood (1889), the Copley Medal (1893), and Master of Pembroke College (1902). A true ‘natural philosopher,’ Stokes systematically explored hydrodynamics, elasticity, wave mechanics, diffraction, gravity, acoustics, heat, meteorology, and chemistry. His primary research output was from 1840–1860, for he later became tied down with administrative duties.



In hydrodynamics, Stokes has several formulas and fields named after him:

- (1) The equations of motion of a linear viscous fluid: the *Navier-Stokes equations*.
- (2) The motion of nonlinear deep-water surface waves: *Stokes waves*.
- (3) The drag on a sphere at low Reynolds number: *Stokes' formula*,  $F = 3\pi\mu VD$ .
- (4) Flow over immersed bodies for  $Re \ll 1$ : *Stokes flow*.
- (5) A metric (CGS) unit of kinematic viscosity,  $\nu$ :  $1 \text{ cm}^2/\text{s} = 1 \text{ stoke}$ .
- (6) A relation between the 1st and 2nd coefficients of viscosity: *Stokes' hypothesis*.
- (7) A stream function for axisymmetric flow: *Stokes' stream function* [see Chap. 8].

Although Navier, Poisson, and Saint-Venant had made derivations of the equations of motion of a viscous fluid in the 1820's and 1830's, Stokes was quite unfamiliar with the French literature. He published a completely independent derivation in 1845 of the *Navier-Stokes equations* [see Sect. 4.3], using a 'continuum-calculus' rather than a 'molecular' viewpoint, and showed that these equations were directly analogous to the motion of elastic solids. Although not really new, Stokes' equations were notable for being the first to replace the mysterious French 'molecular coefficient'  $\varepsilon$  by the coefficient of absolute viscosity,  $\mu$ .

**1.85-g** Report to the class on the achievements of *Moritz Weber*.

**Solution:** The following notes are from Rouse and Ince [Ref. 23].

Weber (1871–1951) was professor of naval mechanics at the Polytechnic Institute of Berlin. He clarified the principles of similitude (dimensional analysis) in the form used today. It was he who named the Froude number and the Reynolds number in honor of those workers. In a 1919 paper, he developed a dimensionless surface-tension (capillarity) parameter [see Sect. 5.4] which was later named the *Weber number* in his honor.

**1.85-h** Report to the class on the achievements of *Theodor von Kármán*.

**Solution:** The following notes are abstracted from the *Dictionary of Scientific Biography* (see Prob. 1.85-a). Another good reference is his ghost-written (by Lee Edson) autobiography, *The Wind and Beyond*, Little-Brown, Boston, 1967.

Kármán (1881–1963) was born in Budapest, Hungary, to distinguished and well-educated parents. He attended the Technical University of Budapest and in 1906 received a fellowship to Göttingen, where he worked for six years with Ludwig Prandtl, who had just developed boundary layer theory. He received a doctorate in 1912 from Göttingen and was then appointed director of aeronautics at the Polytechnic Institute of Aachen. He remained at Aachen until 1929, when he was named director of the newly formed Guggenheim Aeronautical Laboratory at the California Institute of Technology. Kármán

developed CalTech into a premier research center for aeronautics. His leadership spurred the growth of the aerospace industry in southern California. He helped found the Jet Propulsion Laboratory and the Aerojet General Corporation. After World War II, Kármán founded a research arm for NATO, the Advisory Group for Aeronautical Research and Development, whose renowned educational institute in Brussels is now called the Von Kármán Center.

Kármán was uniquely skilled in integrating physics, mathematics, and fluid mechanics into a variety of phenomena. His most famous paper was written in 1912 to explain the puzzling alternating vortices shed behind cylinders in a steady-flow experiment conducted by K. Hiemenz, one of Kármán's students—these are now called *Kármán vortex streets* [see Fig. 5.2a]. Shed vortices are thought to have caused the destruction by winds of the Tacoma Narrows Bridge in 1940 in Washington State.

Kármán wrote 171 articles and 5 books and his methods had a profound influence on fluid mechanics education in the 20th century.

---

**1.85-i** Report to the class on the achievements of *Paul Richard Heinrich Blasius*.

**Solution:** The following notes are from Rouse and Ince [Ref. 23].

Blasius (1883–1970) was Ludwig Prandtl's first graduate student at Göttingen. His 1908 dissertation gave the analytic solution for the laminar boundary layer on a flat plate [see Sect. 7.4]. Then, in two papers in 1911 and 1913, he gave the first demonstration that pipe-flow resistance could be nondimensionalized as a plot of friction factor versus Reynolds number—the first “Moody-type” chart. His correlation,  $f \approx 0.316 \text{Re}_d^{-1/4}$ , is still in use today. He later worked on analytical solutions of boundary layers with variable pressure gradients.

---

**1.85-j** Report to the class on the achievements of *Ludwig Prandtl*.

**Solution:** The following notes are from Rouse and Ince [Ref. 23].

Ludwig Prandtl (1875–1953) is described by Rouse and Ince [23] as the father of modern fluid mechanics. Born in Munich, the son of a professor, Prandtl studied engineering and received a doctorate in elasticity. But his first job as an engineer made him aware of the lack of correlation between theory and experiment in fluid mechanics. He conducted research from 1901–1904 at the Polytechnic Institute of Hanover and presented a seminal paper in 1904, outlining the new concept of “boundary layer theory.” He was promptly hired as professor and director of applied mechanics at the University of Göttingen, where he remained throughout his career. He, and his dozens of famous students, started a new “engineering science” of fluid mechanics, emphasizing (1) mathematical analysis based upon physical reasoning; (2) new experimental techniques; and (3) new and inspired flow-visualization schemes which greatly increased our understanding of flow phenomena.

In addition to boundary-layer theory, Prandtl made important contributions to (1) wing theory; (2) turbulence modeling; (3) supersonic flow; (4) dimensional analysis; and (5) instability and transition of laminar flow. He was a legendary engineering professor.

---

**1.85-k** Report to the class on the achievements of *Osborne Reynolds*.

**Solution:** The following notes are from Rouse and Ince [Ref. 23].

Osborne Reynolds (1842–1912) was born in Belfast, Ireland, to a clerical family and studied mathematics at Cambridge University. In 1868 he was appointed chair of engineering at a college which is now known as the University of Manchester Institute of Science and Technology (UMIST). He wrote on wide-ranging topics—mechanics, electricity, navigation—and developed a new hydraulics laboratory at UMIST. He was the first person to demonstrate cavitation, that is, formation of vapor bubbles due to high velocity and low pressure. His most famous experiment, still performed in the undergraduate laboratory at UMIST (see Fig. 6.5 in the text) demonstrated transition of laminar pipe flow into turbulence. He also showed in this experiment that the viscosity was very important and led him to the dimensionless stability parameter  $\rho VD/\mu$  now called the *Reynolds number* in his honor. Perhaps his most important paper, in 1894, extended the Navier-Stokes equations (see Eqs. 4.38 of the text) to time-averaged randomly fluctuating turbulent flow, with a result now called the *Reynolds equations* of turbulence. Reynolds also contributed to the concept of the *control volume* which forms the basis of integral analysis of flow (Chap. 3).

---

**1.85-l** Report to the class on the achievements of *John William Strutt, Lord Rayleigh*.

**Solution:** The following notes are from Rouse and Ince [Ref. 23].

John William Strutt (1842–1919) was born in Essex, England, and inherited the title Lord Rayleigh. He studied at Cambridge University and was a traditional hydrodynamicist in the spirit of Euler and Stokes. He taught at Cambridge most of his life and also served as president of the Royal Society. He is most famous for his work (and his textbook) on the theory of sound. In 1904 he won the Nobel Prize for the discovery of argon gas. He made at least five important contributions to hydrodynamics: (1) the equations of bubble dynamics in liquids, now known as *Rayleigh-Plesset theory*; (2) the theory of nonlinear surface waves; (3) the capillary (surface tension) instability of jets; (4) the “heat-transfer analogy” to laminar flow; and (5) dimensional similarity, especially related to viscosity data for argon gas and later generalized into group theory which previewed Buckingham’s Pi Theorem. He ended his career as president, in 1909, of the first British committee on aeronautics.

---

**1.85-m** Report to the class on the achievements of *Daniel Bernoulli*.

**Solution:** The following notes are from Rouse and Ince [Ref. 23].

Daniel Bernoulli (1700–1782) was born in Groningen, Holland, his father, Johann, being a Dutch professor. He studied at the University of Basel, Switzerland, and taught mathematics for a few years at St. Petersburg, Russia. There he wrote, and published in 1738, his famous treatise *Hydrodynamica*, for which he is best known. This text contained numerous ingenious drawings illustrating various flow phenomena. Bernoulli used energy concepts to establish proportional relations between kinetic and potential energy, with pressure work added only in the abstract. Thus he never actually derived the famous equation now bearing his name (Eq. 3.77 of the text), later derived in 1755 by his friend Leonhard Euler. Daniel Bernoulli never married and thus never contributed additional members to his famous family of mathematicians.

---

**1.85-n** Report to the class on the achievements of *Leonhard Euler*.

**Solution:** The following notes are from Rouse and Ince [Ref. 23].

Leonhard Euler (1707–1783) was born in Basel, Switzerland, and studied mathematics under Johann Bernoulli, Daniel's father. He succeeded Daniel Bernoulli as professor of mathematics at the St. Petersburg Academy, leaving there in 1741 to join the faculty of Berlin University. He lost his sight in 1766 but continued to work, aided by a prodigious memory, and produced a vast output of scientific papers, dealing with mathematics, optics, mechanics, hydrodynamics, and celestial mechanics (for which he is most famous today). His famous paper of 1755 on fluid flow derived the full inviscid equations of fluid motion (Eqs. 4.36 of the text) now called *Euler's equations*. He used a fixed coordinate system, now called the *Eulerian frame of reference*. The paper also presented, for the first time, the correct form of Bernoulli's equation (Eq. 3.77 of the text). Separately, in 1754 he produced a seminal paper on the theory of reaction turbines, leading to *Euler's turbine equation* (Eq. 11.11 of the text).

---

**FUNDAMENTALS OF ENGINEERING EXAM PROBLEMS: Answers**

- FE-1.1 The absolute viscosity  $\mu$  of a fluid is primarily a function of  
 (a) density (b) **temperature** (c) pressure (d) velocity (e) surface tension
- FE-1.2 If a uniform solid body weighs 50 N in air and 30 N in water, its specific gravity is  
 (a) 1.5 (b) 1.67 (c) **2.5** (d) 3.0 (e) 5.0
- FE-1.3 Helium has a molecular weight of 4.003. What is the weight of 2 cubic meters of helium at 1 atmosphere and 20°C?  
 (a) **3.3 N** (b) 6.5 N (c) 11.8 N (d) 23.5 N (e) 94.2 N
- FE-1.4 An oil has a kinematic viscosity of  $1.25\text{E}-4$  m<sup>2</sup>/s and a specific gravity of 0.80. What is its dynamic (absolute) viscosity in kg/(m·s)?  
 (a) 0.08 (b) **0.10** (c) 0.125 (d) 1.0 (e) 1.25
- FE-1.5 Consider a soap bubble of diameter 3 mm. If the surface tension coefficient is 0.072 N/m and external pressure is 0 Pa gage, what is the bubble's internal gage pressure?  
 (a) -24 Pa (b) +48 Pa (c) +96 Pa (d) **+192 Pa** (e) -192 Pa
- FE-1.6 The only possible dimensionless group which combines velocity  $V$ , body size  $L$ , fluid density  $\rho$ , and surface tension coefficient  $\sigma$  is:  
 (a)  $L\rho\sigma/V$  (b)  $\rho VL^2/\sigma$  (c)  $\rho\sigma V^2/L$  (d)  $\sigma LV^2/\rho$  (e)  **$\rho LV^2/\sigma$**
- FE-1.7 Two parallel plates, one moving at 4 m/s and the other fixed, are separated by a 5-mm-thick layer of oil of specific gravity 0.80 and kinematic viscosity  $1.25\text{E}-4$  m<sup>2</sup>/s. What is the average shear stress in the oil?  
 (a) **80 Pa** (b) 100 Pa (c) 125 Pa (d) 160 Pa (e) 200 Pa
- FE-1.8 Carbon dioxide has a specific heat ratio of 1.30 and a gas constant of 189 J/(kg·°C). If its temperature rises from 20°C to 45°C, what is its internal energy rise?  
 (a) 12.6 kJ/kg (b) **15.8 kJ/kg** (c) 17.6 kJ/kg (d) 20.5 kJ/kg (e) 25.1 kJ/kg
- FE-1.9 A certain water flow at 20°C has a critical cavitation number, where bubbles form,  $Ca \approx 0.25$ , where  $Ca = 2(p_a - p_{\text{vap}})/(\rho V^2)$ . If  $p_a = 1$  atm and the vapor pressure is 0.34 psia, for what water velocity will bubbles form?  
 (a) 12 mi/hr (b) 28 mi/hr (c) 36 mi/hr (d) 55 mi/hr (e) **63 mi/hr**
- FE-1.10 A steady incompressible flow, moving through a contraction section of length  $L$ , has a one-dimensional average velocity distribution given by  $u \approx U_o(1+2x/L)$ . What is its convective acceleration at the end of the contraction,  $x = L$ ?  
 (a)  $U_o^2/L$  (b)  $2U_o^2/L$  (c)  $3U_o^2/L$  (d)  $4U_o^2/L$  (e)  **$6U_o^2/L$**

## COMPREHENSIVE PROBLEMS

**C1.1** Sometimes equations can be developed and practical problems solved by knowing nothing more than the dimensions of the key parameters. For example, consider the heat loss through a window in a building. Window efficiency is rated in terms of “R value,” which has units of  $\text{ft}^2 \cdot \text{hr} \cdot ^\circ\text{F}/\text{Btu}$ . A certain manufacturer offers a double-pane window with  $R = 2.5$  and also a triple-pane window with  $R = 3.4$ . Both windows are 3 ft by 5 ft. On a given winter day, the temperature difference between inside and outside is  $45^\circ\text{F}$ . (a) Develop an equation for window heat loss  $Q$ , in time period  $\Delta t$ , as a function of window area  $A$ , R value, and temperature difference  $\Delta T$ . How much heat is lost through the above (a) double-pane window, or (b) triple-pane window, in 24 hours? (c) Suppose the building is heated with propane gas, at \$1.25 per gallon, burning at 80% efficiency. Propane has 90,000 Btu of available energy per gallon. In a 24-hour period, how much money would a homeowner save, per window, by installing a triple-pane rather than a double-pane window? (d) Finally, suppose the homeowner buys 20 such triple-pane windows for the house. A typical winter equals about 120 heating days at  $\Delta T = 45^\circ\text{F}$ . Each triple-pane window costs \$85 more than the double-pane window. Ignoring interest and inflation, how many years will it take the homeowner to make up the additional cost of the triple-pane windows from heating bill savings?

**Solution:** (a) The function  $Q = \text{fcn}(\Delta t, R, A, \Delta T)$  must have units of Btu. The only combination of units which accomplishes this is:

$$Q = \frac{\Delta t \Delta T A}{R} \quad \text{Ans.} \quad \text{Thus } Q_{\text{lost}} = \frac{(24 \text{ hr})(45^\circ\text{F})(3 \text{ ft} \cdot 5 \text{ ft})}{2.5 \text{ ft}^2 \cdot \text{hr} \cdot ^\circ\text{F}/\text{Btu}} = \mathbf{6480 \text{ Btu}} \quad \text{Ans. (a)}$$

(b) Triple-pane window: use  $R = 3.4$  instead of 2.5 to obtain  $Q_{3\text{-pane}} = \mathbf{4760 \text{ Btu}}$     *Ans. (b)*

(c) The savings, using propane, for one triple-pane window for one 24-hour period is:

$$\Delta \text{Cost} = \frac{\$1.25/\text{gal}}{90000 \text{ Btu}/\text{gal}} (6480 - 4760 \text{ Btu}) \frac{1}{0.80_{\text{efficiency}}} = \$0.030 = \mathbf{3 \text{ cents}} \quad \text{Ans. (c)}$$

(d) Extrapolate to 20 windows, 120 cold days per year, and \$85 extra cost per window:

$$\text{Pay-back time} = \frac{\$85/\text{window}}{(\$0.030/\text{window}/\text{day})(120 \text{ days}/\text{year})} = \mathbf{24 \text{ years}} \quad \text{Ans. (d)}$$

Not a good investment. We are using ‘\$’ and ‘windows’ as “units” in our equations!

---

**C1.2** When a person ice-skates, the ice surface actually melts beneath the blades, so that he or she skates on a thin film of water between the blade and the ice. (a) Find an expression for total friction force  $F$  on the bottom of the blade as a function of skater velocity  $V$ , blade length  $L$ , water film thickness  $h$ , water viscosity  $\mu$ , and blade width  $W$ . (b) Suppose a skater of mass  $m$ , moving at constant speed  $V_o$ , suddenly stands stiffly with skates pointed directly forward and allows herself to coast to a stop. Neglecting air resistance, how far will she travel (on *two* blades) before she stops? Give the answer  $X$  as a function of  $(V_o, m, L, h, \mu, W)$ . (c) Compute  $X$  for the case  $V_o = 4$  m/s,  $m = 100$  kg,  $L = 30$  cm,  $W = 5$  mm, and  $h = 0.1$  mm. Do you think our assumption of negligible air resistance was a good one?

**Solution:** (a) The skate bottom and the melted ice are like two parallel plates:

$$\tau = \mu \frac{V}{h}, \quad F = \tau A = \frac{\mu VLW}{h} \quad \text{Ans. (a)}$$

(b) Use  $\mathbf{F} = m\mathbf{a}$  to find the stopping distance:

$$\Sigma F_x = -F = -\frac{2\mu VLW}{h} = ma_x = m \frac{dV}{dt}$$

(the '2' is for two blades)

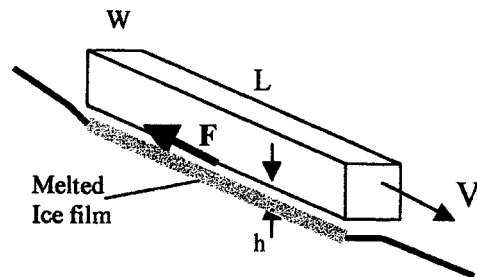
Separate and integrate once to find the velocity, once again to find the distance traveled:

$$\int \frac{dV}{V} = -\int \frac{2\mu LW}{mh} dt, \quad \text{or: } V = V_o e^{-\frac{2\mu LW}{mh}t}, \quad X = \int_0^{\infty} V dt = \frac{V_o mh}{2\mu LW} \quad \text{Ans. (b)}$$

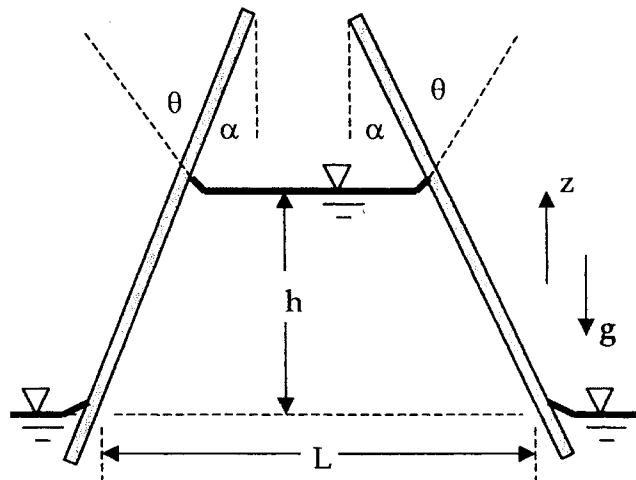
(c) Apply our specific numerical values to a 100-kg (!) person:

$$X = \frac{(4.0 \text{ m/s})(100 \text{ kg})(0.0001 \text{ m})}{2(1.788E-3 \text{ kg/m}\cdot\text{s})(0.3 \text{ m})(0.005 \text{ m})} = \mathbf{7460 \text{ m (!)}} \quad \text{Ans. (c)}$$

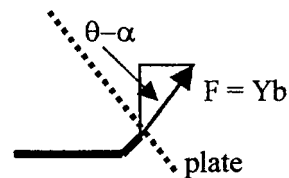
We could coast to the next town on ice skates! It appears that our assumption of negligible air drag was grossly incorrect.



**C1.3** Two thin flat plates are tilted at an angle  $\alpha$  and placed in a tank of known surface tension  $Y$  and contact angle  $\theta$ , as shown. At the free surface of the liquid in the tank, the two plates are a distance  $L$  apart, and of width  $b$  into the paper. (a) What is the total  $z$ -directed force, due to surface tension, acting on the liquid column between plates? (b) If the liquid density is  $\rho$ , find an expression for  $Y$  in terms of the other variables.



**Solution:** (a) Considering the right side of the liquid column, the surface tension acts tangent to the local surface, that is, along the dashed line at right. This force has magnitude  $F = Yb$ , as shown. Its vertical component is  $F \cos(\theta - \alpha)$ , as shown. There are two plates. Therefore, the total  $z$ -directed force on the liquid column is



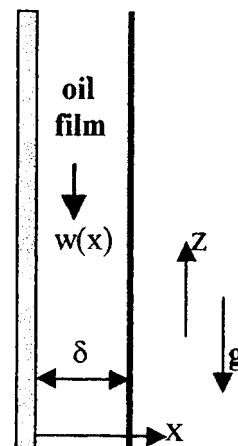
$$F_{\text{vertical}} = 2Yb \cos(\theta - \alpha) \quad \text{Ans. (a)}$$

(b) The vertical force in (a) above holds up the entire weight of the liquid column between plates, which is  $W = \rho g \{bh(L - h \tan \alpha)\}$ . Set  $W$  equal to  $F$  and solve for

$$U = [\rho g b h (L - h \tan \alpha)] / [2 \cos(\theta - \alpha)] \quad \text{Ans. (b)}$$

**C1.4** Oil of viscosity  $\mu$  and density  $\rho$  drains steadily down the side of a tall, wide vertical plate, as shown. The film is fully developed, that is, its thickness  $\delta$  and velocity profile  $w(x)$  are independent of distance  $z$  down the plate. Assume that the atmosphere offers no shear resistance to the film surface.

(a) Sketch the approximate shape of the velocity profile  $w(x)$ , keeping in mind the boundary conditions.





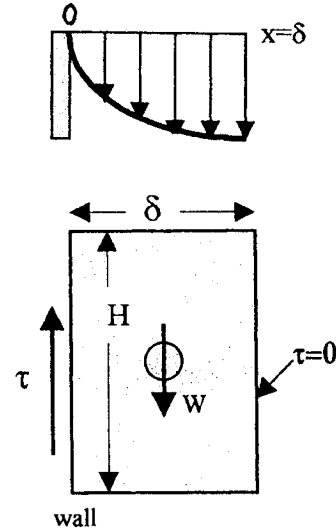
(b) Suppose film thickness  $\delta$  is measured, along with the slope of the velocity profile at the wall,  $(dw/dx)_{wall}$ , with a laser-Doppler anemometer (Chap. 6). Find an expression for  $\mu$  as a function of  $\rho$ ,  $\delta$ ,  $(dw/dx)_{wall}$ , and  $g$ . Note that both  $w$  and  $(dw/dx)_{wall}$  will be negative as shown.

**Solution:** (a) The velocity profile must be such that there is no slip ( $w = 0$ ) at the wall and no shear ( $dw/dx = 0$ ) at the film surface. This is shown at right. *Ans.* (a)  
 (b) Consider a freebody of any vertical length  $H$  of film, as at right. Since there is no acceleration (fully developed film), the weight of the film must exactly balance the shear force on the wall:

$$W = \rho g(H\delta b) = \tau_{wall}(Hb), \quad \tau_{wall} = -\mu \left. \frac{dw}{dx} \right|_{wall}$$

Solve this equality for the fluid viscosity:

$$\mu = \frac{-\rho g \delta}{(dw/dx)_{wall}} \quad \text{Ans. (b)}$$



**C1.5** Viscosity can be measured by flow through a thin-bore or *capillary* tube if the flow rate is low. For length  $L$ , (small) diameter  $D \ll L$ , pressure drop  $\Delta p$ , and (low) volume flow rate  $Q$ , the formula for viscosity is  $\mu = D^4 \Delta p / (CLQ)$ , where  $C$  is a constant. (a) Verify that  $C$  is dimensionless. The following data are for water flowing through a 2-mm-diameter tube which is 1 meter long. The pressure drop is held constant at  $\Delta p = 5$  kPa.

$T, ^\circ\text{C}:$	10.0	40.0	70.0
$Q, \text{L/min}:$	0.091	0.179	0.292

(b) Using proper SI units, determine an average value of  $C$  by accounting for the variation with temperature of the viscosity of water.

**Solution:** (a) Check the dimensions of the formula and solve for  $\{C\}$ :

$$\{\mu\} = \left\{ \frac{M}{LT} \right\} = \left\{ \frac{D^4 \Delta p}{CLQ} \right\} = \left\{ \frac{L^4 (ML^{-1}T^{-2})}{\{C\}(L)(L^3/T)} \right\} = \left\{ \frac{M}{LT\{C\}} \right\},$$

*therefore*  $\{C\} = \{1\}$  **Dimensionless** *Ans.* (a)

(b) Use the given data, with values of  $\mu_{\text{water}}$  from Table A.1, to evaluate  $C$ , with  $L = 1$  m,  $D = 0.002$  m, and  $\Delta p = 5000$  Pa. Convert the flow rate from L/min to  $\text{m}^3/\text{s}$ .

$T, ^\circ\text{C}$ :	10.0	40.0	70.0
$Q, \text{m}^3/\text{s}$ :	1.52E-6	2.98E-6	4.87E-6
$\mu_{\text{water}}, \text{kg/m}\cdot\text{s}$ :	1.307E-3	0.657E-3	0.405E-3
$C = D^4 \Delta p / (\mu L Q)$ :	40.3	40.9	40.6

The estimated value of  $C = 40.6 \pm 0.3$ . The theoretical value (Chap. 4) is  $C = 128/\pi = 40.74$ .

**C1.6** The *rotating-cylinder viscometer* in Fig. C1.6 shears the fluid in a narrow clearance,  $\Delta r$ , as shown. Assume a linear velocity distribution in the gaps. If the driving torque  $M$  is measured, find an expression for  $\mu$  by (a) neglecting, and (b) including the bottom friction.

**Solution:** (a) The fluid in the annular region has the same shear stress analysis as Prob. 1.49:

$$M = \int R dF = \int (R)(\tau) dA \int_0^{2\pi} R \left( \mu \frac{\Omega R}{\Delta R} \right) RL d\theta = 2\pi\mu \frac{\Omega R^3 L}{\Delta R},$$

$$\text{or: } \mu = \frac{M\Delta R}{2\pi\Omega R^3 L} \quad \text{Ans. (a)}$$

(b) Now add in the moment of the (variable) shear stresses on the bottom of the cylinder:

$$\begin{aligned} M_{\text{bottom}} &= \int r\tau dA = \int_0^R r \left( \mu \frac{\Omega r}{\Delta R} \right) 2\pi r dr \\ &= \frac{2\pi\Omega\mu}{\Delta R} \int_0^R r^3 dr = \frac{2\pi\Omega\mu R^4}{4\Delta R} \end{aligned}$$

$$\text{Thus } M_{\text{total}} = \frac{2\pi\Omega\mu R^3 L}{\Delta R} + \frac{2\pi\Omega\mu R^4}{4\Delta R}$$

$$\text{Solve for } \mu = \frac{M\Delta R}{2\pi\Omega R^3 (L + R/4)} \quad \text{Ans. (b)}$$

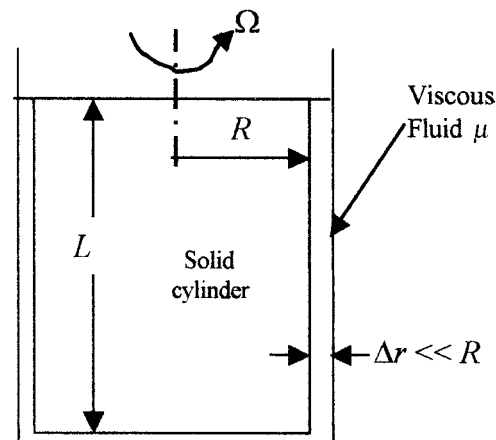


Fig. C1.6

**C1.7** SAE 10W oil at 20°C flows past a flat surface, as in Fig. 1.4(b). The velocity profile  $u(y)$  is measured, with the following results:

$y, \text{ m:}$	0.0	0.003	0.006	0.009	0.012	0.015
$u, \text{ m/s:}$	0.0	1.99	3.94	5.75	7.29	8.46

Using your best interpolating skills, estimate the shear stress in the oil (a) at the wall ( $y = 0$ ); and (b) at  $y = 15 \text{ mm}$ .

**Solution:** For SAE10W oil, from Table A.3, read  $\mu = 0.104 \text{ kg/m}\cdot\text{s}$ . We need to estimate the derivative ( $du/dy$ ) at the two values of  $y$ , then compute  $\tau = \mu(du/dy)$ .

*Method 1:* Use a Newton-Raphson three-point derivative estimate.

At three equally-spaced points,  $du/dy|_{y_0} \approx (-3u_0 + 4u_1 - u_2)/(2\Delta y)$ . Thus

$$(a) \text{ at } y = 0: du/dy|_{y=0} \approx [-3(0.00) + 4(1.99) - (3.94)]/(2\{0.003\}) = 670 \text{ s}^{-1}$$

$$\text{Then } \tau = \mu(du/dy) = (670 \text{ s}^{-1})(0.104 \text{ kg/m}\cdot\text{s}) \approx \mathbf{70 \text{ Pa}} \quad \text{Ans. (a)}$$

$$(b) \text{ at } y = 0.015 \text{ m: } du/dy|_{y=0} \approx [3(8.46) - 4(7.29) + (5.75)]/(2\{0.003\}) = 328 \text{ s}^{-1}$$

$$\text{Then } \tau = \mu(du/dy) = (328 \text{ s}^{-1})(0.104 \text{ kg/m}\cdot\text{s}) \approx \mathbf{34 \text{ Pa}} \quad \text{Ans. (b)}$$

*Method 2:* Type the six data points into Excel and run a cubic “trendline” fit. The result is

$$u \approx 656.2y + 4339.8y^2 - 699163y^3$$

Differentiating this polynomial at  $y = 0$  gives  $du/dy \approx 656.2 \text{ s}^{-1}$ ,  $\tau \approx \mathbf{68 \text{ Pa}}$  Ans. (a)

Differentiating this polynomial at  $y = 0.015$  gives  $du/dy \approx 314 \text{ s}^{-1}$ ,  $\tau \approx \mathbf{33 \text{ Pa}}$  Ans. (b)

**C1.8** A mechanical device, which uses the rotating cylinder of Fig. C1.6, is the *Stormer viscometer* [Ref. 27 of Chap. 1]. Instead of being driven at constant  $\Omega$ , a cord is wrapped around the shaft and attached to a falling weight  $W$ . The time  $t$  to turn the shaft a given number of revolutions (usually 5) is measured and correlated with viscosity. The Stormer formula is

$$t = A\mu/(W - B)$$

where  $A$  and  $B$  are constants which are determined by calibrating the device with a known fluid. Here are calibration data for a Stormer viscometer tested in glycerol, using a weight of 50 N:

$\mu, \text{ kg/m}\cdot\text{s:}$	0.23	0.34	0.57	0.84	1.15
$t, \text{ sec:}$	15	23	38	56	77

(a) Find reasonable values of  $A$  and  $B$  to fit this calibration data. [*Hint*: The data are not very sensitive to the value of  $B$ .] (b) A more viscous fluid is tested with a 100-N weight and the measured time is 44 s. Estimate the viscosity of this fluid.

**Solution:** (a) The data fit well, with a standard deviation of about 0.17 s in the value of  $t$ , to the values

$$A \approx 3000 \quad \text{and} \quad B \approx 3.5 \quad \text{Ans. (a)}$$

(b) With a new fluid and a new weight, the values of  $A$  and  $B$  should nevertheless be the same:

$$t = 44 \text{ s} \approx \frac{A\mu}{W - B} = \frac{3000\mu}{100 \text{ N} - 3.5}, \quad \text{solve for } \mu_{\text{new fluid}} \approx 1.42 \frac{\text{kg}}{\text{m} \cdot \text{s}} \quad \text{Ans. (b)}$$

---

## Chapter 2 • Pressure Distribution in a Fluid

2.1 For the two-dimensional stress field in Fig. P2.1, let

$$\begin{aligned}\sigma_{xx} &= 3000 \text{ psf} & \sigma_{yy} &= 2000 \text{ psf} \\ \sigma_{xy} &= 500 \text{ psf}\end{aligned}$$

Find the shear and normal stresses on plane AA cutting through at  $30^\circ$ .

**Solution:** Make cut “AA” so that it just hits the bottom right corner of the element. This gives the freebody shown at right. Now sum forces normal and tangential to side AA. Denote side length AA as “L.”

$$\begin{aligned}\sum F_{n,AA} = 0 &= \sigma_{AA} L \\ &- (3000 \sin 30 + 500 \cos 30)L \sin 30 \\ &- (2000 \cos 30 + 500 \sin 30)L \cos 30\end{aligned}$$

Solve for  $\sigma_{AA} \approx 2683 \text{ lbf/ft}^2$  Ans. (a)

$$\begin{aligned}\sum F_{t,AA} = 0 &= \tau_{AA} L - (3000 \cos 30 - 500 \sin 30)L \sin 30 - (500 \cos 30 - 2000 \sin 30)L \cos 30 \\ \text{Solve for } \tau_{AA} &\approx 683 \text{ lbf/ft}^2 \text{ Ans. (b)}\end{aligned}$$

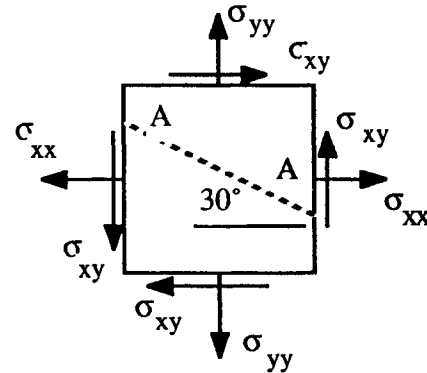
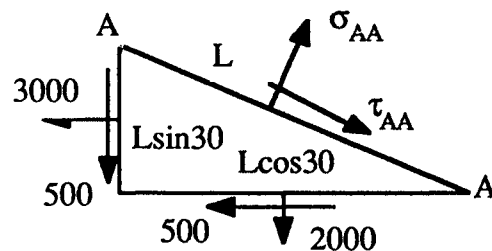


Fig. P2.1



2.2 For the stress field of Fig. P2.1, change the known data to  $\sigma_{xx} = 2000 \text{ psf}$ ,  $\sigma_{yy} = 3000 \text{ psf}$ , and  $\sigma_n(AA) = 2500 \text{ psf}$ . Compute  $\sigma_{xy}$  and the shear stress on plane AA.

**Solution:** Sum forces normal to and tangential to AA in the element freebody above, with  $\sigma_n(AA)$  known and  $\sigma_{xy}$  unknown:

$$\begin{aligned}\sum F_{n,AA} &= 2500L - (\sigma_{xy} \cos 30^\circ + 2000 \sin 30^\circ)L \sin 30^\circ \\ &\quad - (\sigma_{xy} \sin 30^\circ + 3000 \cos 30^\circ)L \cos 30^\circ = 0 \\ \text{Solve for } \sigma_{xy} &= (2500 - 500 - 2250)/0.866 \approx -289 \text{ lbf/ft}^2 \text{ Ans. (a)}\end{aligned}$$

In like manner, solve for the shear stress on plane AA, using our result for  $\sigma_{xy}$ :

$$\begin{aligned}\Sigma F_{t,AA} &= \tau_{AA}L - (2000 \cos 30^\circ + 289 \sin 30^\circ)L \sin 30^\circ \\ &\quad + (289 \cos 30^\circ + 3000 \sin 30^\circ)L \cos 30^\circ = 0\end{aligned}$$

$$\text{Solve for } \tau_{AA} = 938 - 1515 \approx -\mathbf{577 \text{ lbf/ft}^2} \quad \text{Ans. (b)}$$

This problem and Prob. 2.1 can also be solved using Mohr's circle.

**2.3** A vertical clean glass piezometer tube has an inside diameter of 1 mm. When a pressure is applied, water at 20°C rises into the tube to a height of 25 cm. After correcting for surface tension, estimate the applied pressure in Pa.

**Solution:** For water, let  $Y = 0.073 \text{ N/m}$ , contact angle  $\theta = 0^\circ$ , and  $\gamma = 9790 \text{ N/m}^3$ . The capillary rise in the tube, from Example 1.9 of the text, is

$$h_{cap} = \frac{2Y \cos \theta}{\gamma R} = \frac{2(0.073 \text{ N/m}) \cos(0^\circ)}{(9790 \text{ N/m}^3)(0.0005 \text{ m})} = 0.030 \text{ m}$$

Then the rise due to applied pressure is less by that amount:  $h_{press} = 0.25 \text{ m} - 0.03 \text{ m} = 0.22 \text{ m}$ . The applied pressure is estimated to be  $p = \gamma h_{press} = (9790 \text{ N/m}^3)(0.22 \text{ m}) \approx \mathbf{2160 \text{ Pa}}$  Ans.

**2.4** Given a flow pattern with isobars  $p_o - Bz + Cx^2 = \text{constant}$ . Find an expression  $x = \text{fcn}(z)$  for the family of lines everywhere parallel to the local pressure gradient  $\nabla p$ .

**Solution:** Find the slope ( $dx/dz$ ) of the isobars and take the negative inverse and integrate:

$$\frac{d}{dz}(p_o - Bz + Cx^2) = -B + 2Cx \frac{dx}{dz} = 0, \quad \text{or: } \frac{dx}{dz} \Big|_{p=\text{const}} = \frac{B}{2Cx} = \frac{-1}{(dx/dz)_{\text{gradient}}}$$

$$\text{Thus } \frac{dx}{dz} \Big|_{\text{gradient}} = -\frac{2Cx}{B}, \quad \text{integrate } \int \frac{dx}{x} = \int \frac{-2C dz}{B}, \quad \mathbf{x = \text{const } e^{-2Cz/B}} \quad \text{Ans.}$$

**2.5** Atlanta, Georgia, has an average altitude of 1100 ft. On a U.S. standard day, pressure gage A reads 93 kPa and gage B reads 105 kPa. Express these readings in gage or vacuum pressure, whichever is appropriate.

**Solution:** We can find atmospheric pressure by either interpolating in Appendix Table A.6 or, more accurately, evaluate Eq. (2.27) at 1100 ft  $\approx$  335 m:

$$p_a = p_o \left( 1 - \frac{Bz}{T_o} \right)^{g/RB} = (101.35 \text{ kPa}) \left[ 1 - \frac{(0.0065 \text{ K/m})(335 \text{ m})}{288.16 \text{ K}} \right]^{5.26} \approx 97.4 \text{ kPa}$$

Therefore:

$$\text{Gage A} = 93 \text{ kPa} - 97.4 \text{ kPa} = -4.4 \text{ kPa (gage)} = \mathbf{+4.4 \text{ kPa (vacuum)}}$$

$$\text{Gage B} = 105 \text{ kPa} - 97.4 \text{ kPa} = \mathbf{+7.6 \text{ kPa (gage)}}$$
 *Ans.*


---

**2.6** Express standard atmospheric pressure as a head,  $h = p/\rho g$ , in (a) feet of ethylene glycol; (b) inches of mercury; (c) meters of water; and (d) mm of methanol.

**Solution:** Take the specific weights,  $\gamma = \rho g$ , from Table A.3, divide  $p_{\text{atm}}$  by  $\gamma$ :

(a) Ethylene glycol:  $h = (2116 \text{ lbf/ft}^2)/(69.7 \text{ lbf/ft}^3) \approx \mathbf{30.3 \text{ ft}}$  *Ans. (a)*

(b) Mercury:  $h = (2116 \text{ lbf/ft}^2)/(846 \text{ lbf/ft}^3) = 2.50 \text{ ft} \approx \mathbf{30.0 \text{ inches}}$  *Ans. (b)*

(c) Water:  $h = (101350 \text{ N/m}^2)/(9790 \text{ N/m}^3) \approx \mathbf{10.35 \text{ m}}$  *Ans. (c)*

(d) Methanol:  $h = (101350 \text{ N/m}^2)/(7760 \text{ N/m}^3) = 13.1 \text{ m} \approx \mathbf{13100 \text{ mm}}$  *Ans. (d)*

---

**2.7** The deepest point in the ocean is 11034 m in the Mariana Trench in the Pacific. At this depth  $\gamma_{\text{seawater}} \approx 10520 \text{ N/m}^3$ . Estimate the absolute pressure at this depth.

**Solution:** Seawater specific weight at the surface (Table 2.1) is  $10050 \text{ N/m}^3$ . It seems quite reasonable to average the surface and bottom weights to predict the bottom pressure:

$$p_{\text{bottom}} \approx p_o + \gamma_{\text{avg}} h = 101350 + \left( \frac{10050 + 10520}{2} \right) (11034) = 1.136\text{E}8 \text{ Pa} \approx \mathbf{1121 \text{ atm}}$$
 *Ans.*


---

**2.8** A diamond mine is 2 miles below sea level. (a) Estimate the air pressure at this depth. (b) If a barometer, accurate to 1 mm of mercury, is carried into this mine, how accurately can it estimate the depth of the mine?

**Solution:** (a) Convert 2 miles = 3219 m and use a linear-pressure-variation estimate:

$$\text{Then } p \approx p_a + \gamma h = 101,350 \text{ Pa} + (12 \text{ N/m}^3)(3219 \text{ m}) = 140,000 \text{ Pa} \approx \mathbf{140 \text{ kPa}} \quad \text{Ans. (a)}$$

Alternately, the troposphere formula, Eq. (2.27), predicts a slightly higher pressure:

$$\begin{aligned} p &\approx p_a(1 - Bz/T_o)^{5.26} = (101.3 \text{ kPa})[1 - (0.0065 \text{ K/m})(-3219 \text{ m})/288.16 \text{ K}]^{5.26} \\ &= \mathbf{147 \text{ kPa}} \quad \text{Ans. (a)} \end{aligned}$$

(b) The gage pressure at this depth is approximately 40,000/133,100  $\approx$  0.3 m Hg or 300 mm Hg  $\pm$  1 mm Hg or  $\pm$ 0.3% error. Thus the error in the actual depth is 0.3% of 3220 m or about  $\pm$ 10 m if all other parameters are accurate. *Ans. (b)*

**2.9** Integrate the hydrostatic relation by assuming that the isentropic bulk modulus,  $B = \rho(\partial p / \partial \rho)_s$ , is constant. Apply your result to the Mariana Trench, Prob. 2.7.

**Solution:** Begin with Eq. (2.18) written in terms of B:

$$\begin{aligned} dp = -\rho g dz = \frac{B}{\rho} d\rho, \quad \text{or: } \int_{\rho_o}^{\rho} \frac{d\rho}{\rho^2} = -\frac{g}{B} \int_0^z dz = -\frac{1}{\rho} + \frac{1}{\rho_o} = -\frac{gz}{B}, \quad \text{also integrate:} \\ \int_{p_o}^p dp = B \int_{\rho_o}^{\rho} \frac{d\rho}{\rho} \quad \text{to obtain } p - p_o = B \ln(\rho/\rho_o) \end{aligned}$$

Eliminate  $\rho$  between these two formulas to obtain the desired pressure-depth relation:

$$p = p_o - B \ln \left( 1 + \frac{g\rho_o z}{B} \right) \quad \text{Ans. (a)} \quad \text{With } B_{\text{seawater}} \approx 2.33\text{E}9 \text{ Pa from Table A.3,}$$

$$\begin{aligned} p_{\text{Trench}} &= 101350 - (2.33\text{E}9) \ln \left[ 1 + \frac{(9.81)(1025)(-11034)}{2.33\text{E}9} \right] \\ &= 1.138\text{E}8 \text{ Pa} \approx \mathbf{1123 \text{ atm}} \quad \text{Ans. (b)} \end{aligned}$$

**2.10** A closed tank contains 1.5 m of SAE 30 oil, 1 m of water, 20 cm of mercury, and an air space on top, all at 20°C. If  $p_{\text{bottom}} = 60 \text{ kPa}$ , what is the pressure in the air space?

**Solution:** Apply the hydrostatic formula down through the three layers of fluid:

$$p_{\text{bottom}} = p_{\text{air}} + \gamma_{\text{oil}} h_{\text{oil}} + \gamma_{\text{water}} h_{\text{water}} + \gamma_{\text{mercury}} h_{\text{mercury}}$$

$$\text{or: } 60000 \text{ Pa} = p_{\text{air}} + (8720 \text{ N/m}^3)(1.5 \text{ m}) + (9790)(1.0 \text{ m}) + (133100)(0.2 \text{ m})$$

Solve for the pressure in the air space:  $p_{\text{air}} \approx \mathbf{10500 \text{ Pa}}$  *Ans.*



**2.11** In Fig. P2.11, sensor A reads 1.5 kPa (gage). All fluids are at 20°C. Determine the elevations  $Z$  in meters of the liquid levels in the open piezometer tubes B and C.

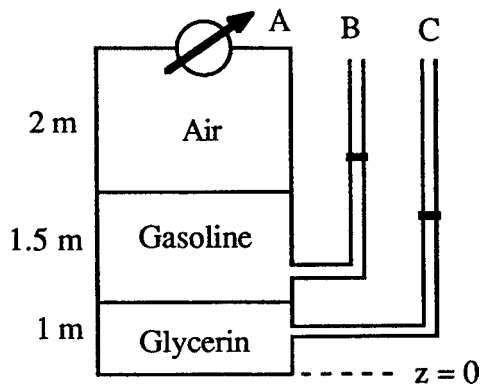


Fig. P2.11

**Solution:** (B) Let piezometer tube B be an arbitrary distance  $H$  above the gasoline-glycerin interface. The specific weights are  $\gamma_{\text{air}} \approx 12.0 \text{ N/m}^3$ ,  $\gamma_{\text{gasoline}} = 6670 \text{ N/m}^3$ , and  $\gamma_{\text{glycerin}} = 12360 \text{ N/m}^3$ . Then apply the hydrostatic formula from point A to point B:

$$1500 \text{ N/m}^2 + (12.0 \text{ N/m}^3)(2.0 \text{ m}) + 6670(1.5 - H) - 6670(Z_B - H - 1.0) = p_B = 0 \text{ (gage)}$$

$$\text{Solve for } Z_B = \mathbf{2.73 \text{ m}} \quad (23 \text{ cm above the gasoline-air interface}) \quad \text{Ans. (b)}$$

Solution (C): Let piezometer tube C be an arbitrary distance  $Y$  above the bottom. Then

$$1500 + 12.0(2.0) + 6670(1.5) + 12360(1.0 - Y) - 12360(Z_C - Y) = p_C = 0 \text{ (gage)}$$

$$\text{Solve for } Z_C = \mathbf{1.93 \text{ m}} \quad (93 \text{ cm above the gasoline-glycerin interface}) \quad \text{Ans. (c)}$$

**2.12** In Fig. P2.12 the tank contains water and immiscible oil at 20°C. What is  $h$  in centimeters if the density of the oil is  $898 \text{ kg/m}^3$ ?

**Solution:** For water take the density =  $998 \text{ kg/m}^3$ . Apply the hydrostatic relation from the oil surface to the water surface, skipping the 8-cm part:

$$p_{\text{atm}} + (898)(g)(h + 0.12) - (998)(g)(0.06 + 0.12) = p_{\text{atm}}$$

$$\text{Solve for } h \approx 0.08 \text{ m} \approx \mathbf{8.0 \text{ cm}} \quad \text{Ans.}$$

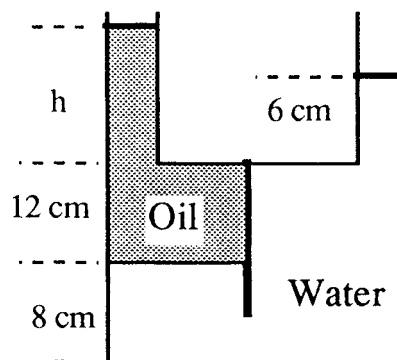


Fig. P2.12

**2.13** In Fig. P2.13 the 20°C water and gasoline are open to the atmosphere and are at the same elevation. What is the height  $h$  in the third liquid?

**Solution:** Take water = 9790 N/m<sup>3</sup> and gasoline = 6670 N/m<sup>3</sup>. The bottom pressure must be the same whether we move down through the water or through the gasoline into the third fluid:

$$p_{\text{bottom}} = (9790 \text{ N/m}^3)(1.5 \text{ m}) + 1.60(9790)(1.0) = 1.60(9790)h + 6670(2.5 - h)$$

Solve for  $h = 1.52 \text{ m}$  Ans.

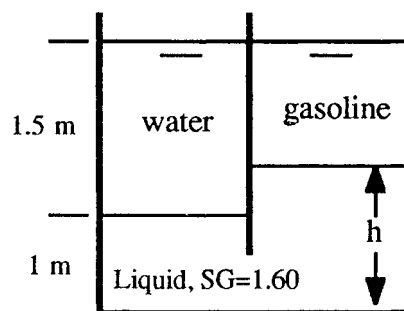


Fig. P2.13

**2.14** The closed tank in Fig. P2.14 is at 20°C. If the pressure at A is 95 kPa absolute, determine  $p$  at B (absolute). What percent error do you make by neglecting the specific weight of the air?

**Solution:** First compute  $\rho_A = p_A/RT = (95000)/[287(293)] \approx 1.13 \text{ kg/m}^3$ , hence  $\gamma_A \approx (1.13)(9.81) \approx 11.1 \text{ N/m}^3$ . Then proceed around hydrostatically from point A to point B:

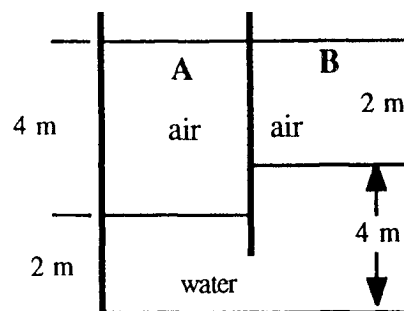


Fig. P2.14

$$95000 \text{ Pa} + (11.1 \text{ N/m}^3)(4.0 \text{ m}) + 9790(2.0) - 9790(4.0) - \left(\frac{p_B}{RT}\right)(9.81)(2.0) = p_B$$

Solve for  $p_B \approx 75450 \text{ Pa}$  Accurate answer.

If we neglect the air effects, we get a much simpler relation with comparable accuracy:

$$95000 + 9790(2.0) - 9790(4.0) \approx p_B \approx 75420 \text{ Pa} \text{ Approximate answer.}$$

**2.15** In Fig. P2.15 all fluids are at 20°C. Gage A reads 15 lbf/in<sup>2</sup> absolute and gage B reads 1.25 lbf/in<sup>2</sup> less than gage C. Compute (a) the specific weight of the oil; and (b) the actual reading of gage C in lbf/in<sup>2</sup> absolute.

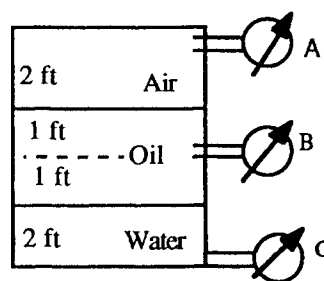


Fig. P2.15

**Solution:** First evaluate  $\gamma_{\text{air}} = (p_A/RT)g = [15 \times 144/(1717 \times 528)](32.2) \approx 0.0767 \text{ lbf/ft}^3$ . Take  $\gamma_{\text{water}} = 62.4 \text{ lbf/ft}^3$ . Then apply the hydrostatic formula from point B to point C:

$$p_B + \gamma_{\text{oil}}(1.0 \text{ ft}) + (62.4)(2.0 \text{ ft}) = p_C = p_B + (1.25)(144) \text{ psf}$$

$$\text{Solve for } \gamma_{\text{oil}} \approx \mathbf{55.2 \text{ lbf/ft}^3} \quad \text{Ans. (a)}$$

With the oil weight known, we can now apply hydrostatics from point A to point C:

$$p_C = p_A + \sum \rho gh = (15)(144) + (0.0767)(2.0) + (55.2)(2.0) + (62.4)(2.0)$$

$$\text{or: } p_C = 2395 \text{ lbf/ft}^2 = \mathbf{16.6 \text{ psi}} \quad \text{Ans. (b)}$$

**2.16** Suppose one wishes to construct a barometer using ethanol at 20°C (Table A-3) as the working fluid. Account for the equilibrium vapor pressure in your calculations and determine how high such a barometer should be. Compare this with the traditional mercury barometer.

**Solution:** From Table A.3 for ethanol at 20°C,  $\rho = 789 \text{ kg/m}^3$  and  $p_{\text{vap}} = 5700 \text{ Pa}$ . For a column of ethanol at 1 atm, the hydrostatic equation would be

$$p_{\text{atm}} - p_{\text{vap}} = \rho_{\text{eth}} g h_{\text{eth}}, \quad \text{or: } 101350 \text{ Pa} - 5700 \text{ Pa} = (789 \text{ kg/m}^3)(9.81 \text{ m/s}^2) h_{\text{eth}}$$

$$\text{Solve for } h_{\text{eth}} \approx \mathbf{12.4 \text{ m}} \quad \text{Ans.}$$

A mercury barometer would have  $h_{\text{merc}} \approx 0.76 \text{ m}$  and would not have the high vapor pressure.

**2.17** All fluids in Fig. P2.17 are at 20°C. If  $p = 1900 \text{ psf}$  at point A, determine the pressures at B, C, and D in psf.

**Solution:** Using a specific weight of  $62.4 \text{ lbf/ft}^3$  for water, we first compute  $p_B$  and  $p_D$ :

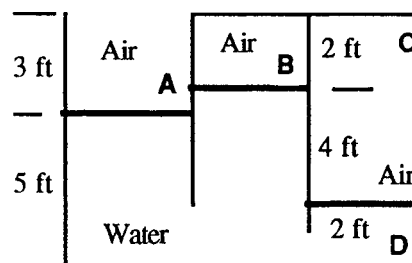


Fig. P2.17

$$p_B = p_A - \gamma_{\text{water}}(z_B - z_A) = 1900 - 62.4(1.0 \text{ ft}) = \mathbf{1838 \text{ lbf/ft}^2} \quad \text{Ans. (pt. B)}$$

$$p_D = p_A + \gamma_{\text{water}}(z_A - z_D) = 1900 + 62.4(5.0 \text{ ft}) = \mathbf{2212 \text{ lbf/ft}^2} \quad \text{Ans. (pt. D)}$$

Finally, moving up from D to C, we can neglect the air specific weight to good accuracy:

$$p_C = p_D - \gamma_{\text{water}}(z_C - z_D) = 2212 - 62.4(2.0 \text{ ft}) = \mathbf{2087 \text{ lbf/ft}^2} \quad \text{Ans. (pt. C)}$$

The air near C has  $\gamma \approx 0.074 \text{ lbf/ft}^3$  times 6 ft yields less than 0.5 psf correction at C.

**2.18** All fluids in Fig. P2.18 are at 20°C. If atmospheric pressure = 101.33 kPa and the bottom pressure is 242 kPa absolute, what is the specific gravity of fluid X?

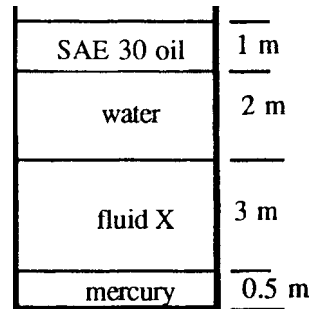


Fig. P2.18

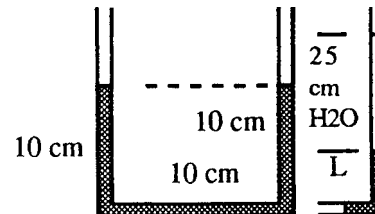
**Solution:** Simply apply the hydrostatic formula from top to bottom:

$$p_{\text{bottom}} = p_{\text{top}} + \sum \gamma h,$$

$$\text{or: } 242000 = 101330 + (8720)(1.0) + (9790)(2.0) + \gamma_X(3.0) + (133100)(0.5)$$

$$\text{Solve for } \gamma_X = 15273 \text{ N/m}^3, \text{ or: } SG_X = \frac{15273}{9790} = \mathbf{1.56} \text{ Ans.}$$

**2.19** The U-tube at right has a 1-cm ID and contains mercury as shown. If 20 cm<sup>3</sup> of water is poured into the right-hand leg, what will be the free surface height in each leg after the sloshing has died down?



**Solution:** First figure the height of water added:

$$20 \text{ cm}^3 = \frac{\pi}{4}(1 \text{ cm})^2 h, \text{ or } h = 25.46 \text{ cm}$$

Then, at equilibrium, the new system must have 25.46 cm of water on the right, and a 30-cm length of mercury is somewhat displaced so that “L” is on the right, 0.1 m on the bottom, and “0.2 – L” on the left side, as shown at right. The bottom pressure is constant:

$$p_{\text{atm}} + 133100(0.2 - L) = p_{\text{atm}} + 9790(0.2546) + 133100(L), \text{ or: } L \approx 0.0906 \text{ m}$$

$$\text{Thus right-leg-height} = 9.06 + 25.46 = \mathbf{34.52 \text{ cm}} \text{ Ans.}$$

$$\text{left-leg-height} = 20.0 - 9.06 = \mathbf{10.94 \text{ cm}} \text{ Ans.}$$

**2.20** The hydraulic jack in Fig. P2.20 is filled with oil at 56 lbf/ft<sup>3</sup>. Neglecting piston weights, what force F on the handle is required to support the 2000-lbf weight shown?

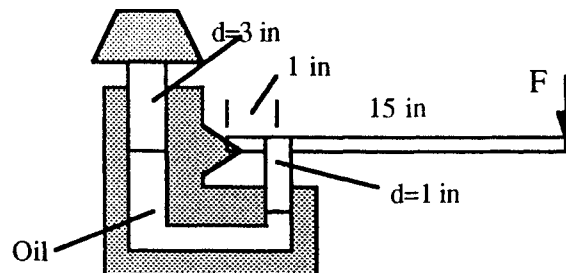


Fig. P2.20

**Solution:** First sum moments clockwise about the hinge A of the handle:

$$\sum M_A = 0 = F(15 + 1) - P(1),$$

or:  $F = P/16$ , where P is the force in the small (1 in) piston.

Meanwhile figure the pressure in the oil from the weight on the large piston:

$$p_{\text{oil}} = \frac{W}{A_{3\text{-in}}} = \frac{2000 \text{ lbf}}{(\pi/4)(3/12 \text{ ft})^2} = 40744 \text{ psf},$$

$$\text{Hence } P = p_{\text{oil}} A_{\text{small}} = (40744) \frac{\pi}{4} \left( \frac{1}{12} \right)^2 = 222 \text{ lbf}$$

Therefore the handle force required is  $F = P/16 = 222/16 \approx \mathbf{14 \text{ lbf}}$  Ans.

**2.21** In Fig. P2.21 all fluids are at 20°C. Gage A reads 350 kPa absolute. Determine (a) the height  $h$  in cm; and (b) the reading of gage B in kPa absolute.

**Solution:** Apply the hydrostatic formula from the air to gage A:

$$\begin{aligned} p_A &= p_{\text{air}} + \sum \gamma h \\ &= 180000 + (9790)h + 133100(0.8) = 350000 \text{ Pa}, \end{aligned}$$

Solve for  $h \approx \mathbf{6.49 \text{ m}}$  Ans. (a)

Then, with  $h$  known, we can evaluate the pressure at gage B:

$$p_B = 180000 + 9790(6.49 + 0.80) = 251000 \text{ Pa} \approx \mathbf{251 \text{ kPa}}$$
 Ans. (b)

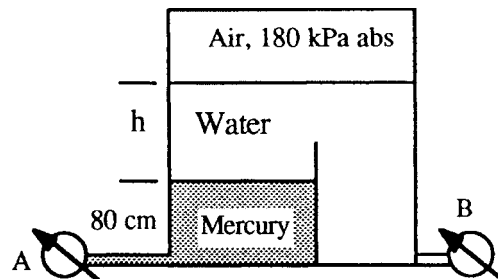


Fig. P2.21

**2.22** The fuel gage for an auto gas tank reads proportional to the bottom gage pressure as in Fig. P2.22. If the tank accidentally contains 2 cm of water plus gasoline, how many centimeters “ $h$ ” of air remain when the gage reads “full” in error?

Fig. P2.22

**Solution:** Given  $\gamma_{\text{gasoline}} = 0.68(9790) = 6657 \text{ N/m}^3$ , compute the pressure when “full”:

$$p_{\text{full}} = \gamma_{\text{gasoline}}(\text{full height}) = (6657 \text{ N/m}^3)(0.30 \text{ m}) = 1997 \text{ Pa}$$

Set this pressure equal to 2 cm of water plus “Y” centimeters of gasoline:

$$p_{\text{full}} = 1997 = 9790(0.02 \text{ m}) + 6657Y, \quad \text{or} \quad Y \approx 0.2706 \text{ m} = 27.06 \text{ cm}$$

Therefore the air gap  $h = 30 \text{ cm} - 2 \text{ cm}(\text{water}) - 27.06 \text{ cm}(\text{gasoline}) \approx \mathbf{0.94 \text{ cm}}$  *Ans.*

**2.23** In Fig. P2.23 both fluids are at 20°C. If surface tension effects are negligible, what is the density of the oil, in  $\text{kg/m}^3$ ?

**Solution:** Move around the U-tube from left atmosphere to right atmosphere:

$$\begin{aligned} p_a + (9790 \text{ N/m}^3)(0.06 \text{ m}) \\ - \gamma_{\text{oil}}(0.08 \text{ m}) &= p_a, \\ \text{solve for } \gamma_{\text{oil}} &\approx 7343 \text{ N/m}^3, \end{aligned}$$

$$\text{or: } \rho_{\text{oil}} = 7343/9.81 \approx \mathbf{748 \text{ kg/m}^3} \quad \text{Ans.}$$

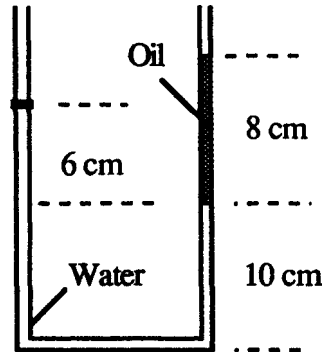


Fig. P2.23

**2.24** In Prob. 1.2 we made a crude integration of atmospheric density from Table A.6 and found that the atmospheric mass is approximately  $m \approx 6.08\text{E}18 \text{ kg}$ . Can this result be used to estimate sea-level pressure? Can sea-level pressure be used to estimate  $m$ ?

**Solution:** Yes, atmospheric pressure is essentially a result of the weight of the air above. Therefore the air weight divided by the surface area of the earth equals sea-level pressure:

$$p_{\text{sea-level}} = \frac{W_{\text{air}}}{A_{\text{earth}}} = \frac{m_{\text{air}}g}{4\pi R_{\text{earth}}^2} \approx \frac{(6.08\text{E}18 \text{ kg})(9.81 \text{ m/s}^2)}{4\pi(6.377\text{E}6 \text{ m})^2} \approx \mathbf{117000 \text{ Pa}} \quad \text{Ans.}$$

This is a little off, thus our mass estimate must have been a little off. If global average sea-level pressure is actually 101350 Pa, then the mass of atmospheric air must be more nearly

$$m_{\text{air}} = \frac{A_{\text{earth}}p_{\text{sea-level}}}{g} \approx \frac{4\pi(6.377\text{E}6 \text{ m})^2(101350 \text{ Pa})}{9.81 \text{ m/s}^2} \approx \mathbf{5.28\text{E}18 \text{ kg}} \quad \text{Ans.}$$

**2.25** Venus has a mass of  $4.90 \times 10^{24}$  kg and a radius of 6050 km. Assume that its atmosphere is 100%  $\text{CO}_2$  (actually it is about 96%). Its surface temperature is 730 K, decreasing to 250 K at about  $z = 70$  km. Average surface pressure is 9.1 MPa. Estimate the pressure on Venus at an altitude of 5 km.

**Solution:** The value of “g” on Venus is estimated from Newton’s law of gravitation:

$$g_{\text{Venus}} = \frac{Gm_{\text{Venus}}}{R_{\text{Venus}}^2} = \frac{(6.67 \times 10^{-11})(4.90 \times 10^{24} \text{ kg})}{(6.05 \times 10^6 \text{ m})^2} \approx 8.93 \text{ m/s}^2$$

Now, from Table A.4, the gas constant for carbon dioxide is  $R_{\text{CO}_2} \approx 189 \text{ m}^2/(\text{s}^2 \cdot \text{K})$ . And we may estimate the Venus temperature lapse rate from the given information:

$$B_{\text{Venus}} \approx \frac{\Delta T}{\Delta z} \approx \frac{730 - 250 \text{ K}}{70000 \text{ m}} \approx 0.00686 \text{ K/m}$$

Finally the exponent in the  $p(z)$  relation, Eq. (2.27), is “n” =  $g/RB = (8.93)/(189 \times 0.00686) \approx 6.89$ . Equation (2.27) may then be used to estimate  $p(z)$  at  $z = 10$  km on Venus:

$$p_{5 \text{ km}} \approx p_o(1 - Bz/T_o)^n \approx (9.1 \text{ MPa}) \left[ 1 - \frac{0.00686 \text{ K/m}(5000 \text{ m})}{730 \text{ K}} \right]^{6.89} \approx \mathbf{6.5 \text{ MPa}} \quad \text{Ans.}$$

**2.26\*** A *polytropic atmosphere* is defined by the Power-law  $p/p_o = (\rho/\rho_o)^m$ , where  $m$  is an exponent of order 1.3 and  $p_o$  and  $\rho_o$  are sea-level values of pressure and density. (a) Integrate this expression in the static atmosphere and find a distribution  $p(z)$ . (b) Assuming an ideal gas,  $p = \rho RT$ , show that your result in (a) implies a linear temperature distribution as in Eq. (2.25). (c) Show that the standard  $B = 0.0065 \text{ K/m}$  is equivalent to  $m = 1.235$ .

**Solution:** (a) In the hydrostatic Eq. (2.18) substitute for density in terms of pressure:

$$dp = -\rho g dz = -[\rho_o(p/p_o)^{1/m}]g dz, \quad \text{or:} \quad \int_{p_o}^p \frac{dp}{p^{1/m}} = -\frac{\rho_o g}{p_o^{1/m}} \int_0^z dz$$

$$\text{Integrate and rearrange to get the result} \quad \frac{p}{p_o} = \left[ 1 - \frac{(m-1)gz}{m(p_o/\rho_o)} \right]^{m/(m-1)} \quad \text{Ans. (a)}$$

(b) Use the ideal-gas relation to relate pressure ratio to temperature ratio for this process:

$$\frac{p}{p_o} = \left( \frac{\rho}{\rho_o} \right)^m = \left( \frac{p}{RT} \frac{RT_o}{p_o} \right)^m \quad \text{Solve for} \quad \frac{T}{T_o} = \left( \frac{p}{p_o} \right)^{(m-1)/m}$$

Using  $p/p_o$  from *Ans.* (a), we obtain  $\frac{T}{T_o} = \left[ 1 - \frac{(m-1)gz}{mRT_o} \right]$  *Ans.* (b)

Note that, in using *Ans.* (a) to obtain *Ans.* (b), we have substituted  $p_o/\rho_o = RT_o$ .

(c) Comparing *Ans.* (b) with the text, Eq. (2.27), we find that lapse rate “ $B$ ” in the text is equal to  $(m-1)g/(mR)$ . Solve for  $m$  if  $B = 0.0065$  K/m:

$$m = \frac{g}{g - BR} = \frac{9.81 \text{ m/s}^2}{9.81 \text{ m/s}^2 - (0.0065 \text{ K/m})(287 \text{ m}^2/\text{s}^2 - R)} = \mathbf{1.235} \quad \textit{Ans. (c)}$$

**2.27** This is an *experimental* problem: Put a card or thick sheet over a glass of water, hold it tight, and turn it over without leaking (a glossy postcard works best). Let go of the card. Will the card stay attached when the glass is upside down? **Yes:** This is essentially a *water barometer* and, in principle, could hold a column of water up to 10 ft high!

**2.28** What is the uncertainty in using pressure measurement as an altimeter? A gage on an airplane measures a local pressure of 54 kPa with an uncertainty of 3 kPa. The lapse rate is 0.006 K/m with an uncertainty of 0.001 K/m. Effective sea-level temperature is 10°C with an uncertainty of 5°C. Effective sea-level pressure is 100 kPa with an uncertainty of 2 kPa. Estimate the plane’s altitude and its uncertainty.

**Solution:** Based on average values in Eq. (2.27), ( $p = 54$  kPa,  $p_o = 100$  kPa,  $B = 0.006$  K/m,  $T_o = 10^\circ\text{C}$ ),  $z_{\text{avg}} \approx \mathbf{4835}$  m. Considering each variable separately ( $p$ ,  $p_o$ ,  $B$ ,  $T_o$ ), their predicted variations in altitude, from Eq. (2.27), are 8.5%, 3.1%, 0.9%, and 1.8%, respectively. Thus measured local pressure is the largest cause of altitude uncertainty. According to uncertainty theory, Eq. (1.43), the overall uncertainty is  $\delta z = [(8.5)^2 + (3.1)^2 + (0.9)^2 + (1.8)^2]^{1/2} = 9.3\%$ , or about 450 meters. Thus we can state the altitude as  $z \approx \mathbf{4840 \pm 450}$  m. *Ans.*

**2.29** Show that, for an *adiabatic* atmosphere,  $p = C(\rho)^k$ , where  $C$  is constant, that

$$p/p_o = \left[ 1 - \frac{(k-1)gz}{kRT_o} \right]^{k/(k-1)}, \quad \text{where } k = c_p/c_v$$

Compare this formula for air at 5 km altitude with the U.S. standard atmosphere.

**Solution:** Introduce the adiabatic assumption into the basic hydrostatic relation (2.18):

$$\frac{dp}{dz} = -\rho g = \frac{d(C\rho^k)}{dz} = kC\rho^{k-1} \frac{d\rho}{dz}$$



Separate the variables and integrate:

$$\int C\rho^{k-2} d\rho = -\int \frac{g}{k} dz, \quad \text{or:} \quad \frac{C\rho^{k-1}}{k-1} = -\frac{gz}{k} + \text{constant}$$

The constant of integration is related to  $z = 0$ , that is, “constant” =  $C\rho_0^{k-1}/(k-1)$ . Divide this constant out and rewrite the relation above:

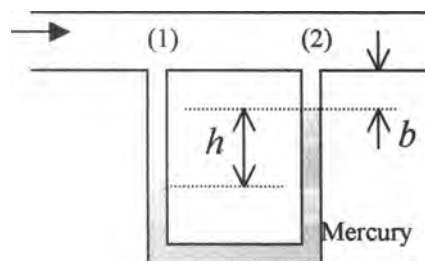
$$\left(\frac{\rho}{\rho_0}\right)^{k-1} = 1 - \frac{(k-1)gz}{kC\rho_0^{k-1}} = (p/p_0)^{(k-1)/k} \quad \text{since } p = C\rho^k$$

Finally, note that  $C\rho_0^{k-1} = C\rho_0^k/\rho_0 = p_0/\rho_0 = RT_0$ , where  $T_0$  is the surface temperature. Thus the final desired pressure relation for an adiabatic atmosphere is

$$\frac{p}{p_0} = \left[1 - \frac{(k-1)gz}{kRT_0}\right]^{k/(k-1)} \quad \text{Ans.}$$

At  $z = 5,000$  m, Table A.6 gives  $p = 54008$  Pa, while the adiabatic formula, with  $k = 1.40$ , gives  $p = \mathbf{52896}$  Pa, or 2.1% lower.

**2.30** A mercury manometer is connected at two points to a horizontal  $20^\circ\text{C}$  water-pipe flow. If the manometer reading is  $h = 35$  cm, what is the pressure drop between the two points?



**Solution:** This is a classic manometer relation. The two legs of water of height  $b$  cancel out:

$$p_1 + 9790b + 9790h - 133100h - 9790b = p_2$$

$$p_1 - p_2 = (133,100 - 9790 \text{ N/m}^3)(0.35 \text{ m}) \approx \mathbf{43100 \text{ Pa}} \quad \text{Ans.}$$

**2.31** In Fig. P2.31 determine  $\Delta p$  between points A and B. All fluids are at  $20^\circ\text{C}$ .

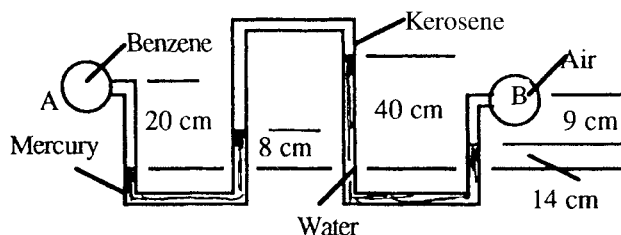


Fig. P2.31

**Solution:** Take the specific weights to be

$$\begin{array}{ll} \text{Benzene:} & 8640 \text{ N/m}^3 \\ \text{Mercury:} & 133100 \text{ N/m}^3 \\ \text{Kerosene:} & 7885 \text{ N/m}^3 \\ \text{Water:} & 9790 \text{ N/m}^3 \end{array}$$

and  $\gamma_{\text{air}}$  will be small, probably around  $12 \text{ N/m}^3$ . Work your way around from A to B:

$$\begin{aligned} p_A + (8640)(0.20 \text{ m}) - (133100)(0.08) - (7885)(0.32) + (9790)(0.26) - (12)(0.09) \\ = p_B, \text{ or, after cleaning up, } p_A - p_B \approx \mathbf{8900 \text{ Pa}} \quad \text{Ans.} \end{aligned}$$

**2.32** For the manometer of Fig. P2.32, all fluids are at  $20^\circ\text{C}$ . If  $p_B - p_A = 97 \text{ kPa}$ , determine the height  $H$  in centimeters.

**Solution:**  $\gamma = 9790 \text{ N/m}^3$  for water and  $133100 \text{ N/m}^3$  for mercury and  $(0.827)(9790) = 8096 \text{ N/m}^3$  for Meriam red oil. Work your way around from point A to point B:

$$\begin{aligned} p_A - (9790 \text{ N/m}^3)(H \text{ meters}) - 8096(0.18) \\ + 133100(0.18 + H + 0.35) = p_B = p_A + 97000. \end{aligned}$$

Solve for  $H \approx 0.226 \text{ m} = \mathbf{22.6 \text{ cm}}$  Ans.

Meriam red oil, SG = 0.827

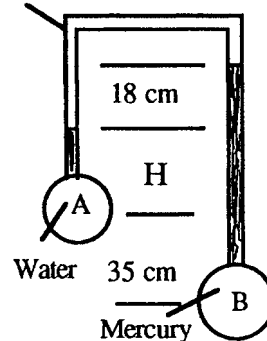


Fig. P2.32

**2.33** In Fig. P2.33 the pressure at point A is 25 psi. All fluids are at  $20^\circ\text{C}$ . What is the air pressure in the closed chamber B?

**Solution:** Take  $\gamma = 9790 \text{ N/m}^3$  for water,  $8720 \text{ N/m}^3$  for SAE 30 oil, and  $(1.45)(9790) = 14196 \text{ N/m}^3$  for the third fluid. Convert the pressure at A from  $25 \text{ lbf/in}^2$  to  $172400 \text{ Pa}$ . Compute hydrostatically from point A to point B:

$$\begin{aligned} p_A + \sum \gamma h = 172400 - (9790 \text{ N/m}^3)(0.04 \text{ m}) + (8720)(0.06) - (14196)(0.10) \\ = p_B = 171100 \text{ Pa} \div 47.88 \div 144 = \mathbf{24.8 \text{ psi}} \quad \text{Ans.} \end{aligned}$$

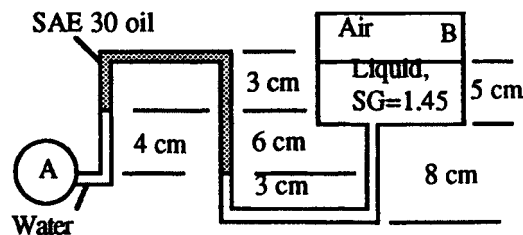


Fig. P2.33

**2.34** To show the effect of manometer dimensions, consider Fig. P2.34. The containers (a) and (b) are cylindrical and are such that  $p_a = p_b$  as shown. Suppose the oil-water interface on the right moves up a distance  $\Delta h < h$ . Derive a formula for the difference  $p_a - p_b$  when (a)  $d \ll D$ ; and (b)  $d = 0.15D$ . What is the % difference?

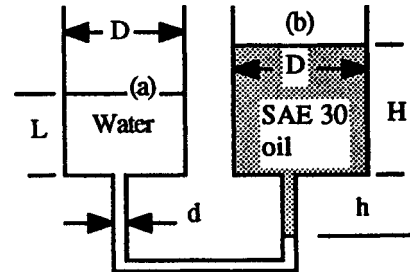


Fig. P2.34

**Solution:** Take  $\gamma = 9790 \text{ N/m}^3$  for water and  $8720 \text{ N/m}^3$  for SAE 30 oil. Let “H” be the height of the oil in reservoir (b). For the condition shown,  $p_a = p_b$ , therefore

$$\gamma_{\text{water}}(L + h) = \gamma_{\text{oil}}(H + h), \quad \text{or: } H = (\gamma_{\text{water}}/\gamma_{\text{oil}})(L + h) - h \quad (1)$$

Case (a),  $d \ll D$ : When the meniscus rises  $\Delta h$ , there will be no significant change in reservoir levels. Therefore we can write a simple hydrostatic relation from (a) to (b):

$$p_a + \gamma_{\text{water}}(L + h - \Delta h) - \gamma_{\text{oil}}(H + h - \Delta h) = p_b,$$

or:  $p_a - p_b = \Delta h(\gamma_{\text{water}} - \gamma_{\text{oil}}) \quad \text{Ans. (a)}$

where we have used Eq. (1) above to eliminate H and L. Putting in numbers to compare later with part (b), we have  $\Delta p = \Delta h(9790 - 8720) = 1070 \Delta h$ , with  $\Delta h$  in meters.

Case (b),  $d = 0.15D$ . Here we must account for reservoir volume changes. For a rise  $\Delta h < h$ , a volume  $(\pi/4)d^2\Delta h$  of water leaves reservoir (a), decreasing “L” by  $\Delta h(d/D)^2$ , and an identical volume of oil enters reservoir (b), increasing “H” by the same amount  $\Delta h(d/D)^2$ . The hydrostatic relation between (a) and (b) becomes, for this case,

$$p_a + \gamma_{\text{water}}[L - \Delta h(d/D)^2 + h - \Delta h] - \gamma_{\text{oil}}[H + \Delta h(d/D)^2 + h - \Delta h] = p_b,$$

or:  $p_a - p_b = \Delta h[\gamma_{\text{water}}(1 + d^2/D^2) - \gamma_{\text{oil}}(1 - d^2/D^2)] \quad \text{Ans. (b)}$

where again we have used Eq. (1) to eliminate H and L. If d is not small, this is a *considerable* difference, with surprisingly large error. For the case  $d = 0.15D$ , with water and oil, we obtain  $\Delta p = \Delta h[1.0225(9790) - 0.9775(8720)] \approx 1486 \Delta h$  or **39% more** than (a).

**2.35** Water flows upward in a pipe slanted at  $30^\circ$ , as in Fig. P2.35. The mercury manometer reads  $h = 12$  cm. What is the pressure difference between points (1) and (2) in the pipe?

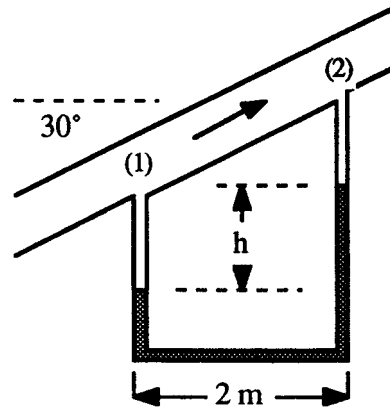


Fig. P2.35

**Solution:** The vertical distance between points 1 and 2 equals  $(2.0 \text{ m})\tan 30^\circ$  or 1.155 m. Go around the U-tube hydrostatically from point 1 to point 2:

$$p_1 + 9790h - 133100h - 9790(1.155 \text{ m}) = p_2,$$

$$\text{or: } p_1 - p_2 = (133100 - 9790)(0.12) + 11300 = \mathbf{26100 \text{ Pa}} \quad \text{Ans.}$$

**2.36** In Fig. P2.36 both the tank and the slanted tube are open to the atmosphere. If  $L = 2.13$  m, what is the angle of tilt  $\phi$  of the tube?

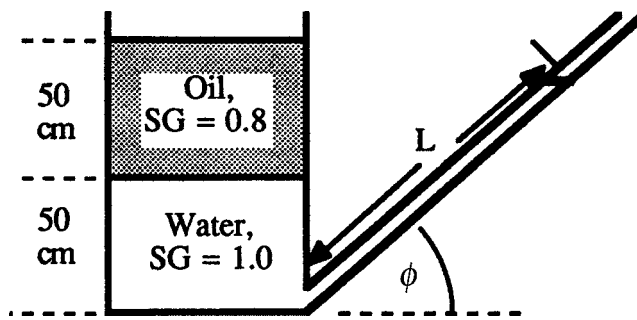


Fig. P2.36

**Solution:** Proceed hydrostatically from the oil surface to the slanted tube surface:

$$p_a + 0.8(9790)(0.5) + 9790(0.5) - 9790(2.13 \sin \phi) = p_a,$$

$$\text{or: } \sin \phi = \frac{8811}{20853} = 0.4225, \quad \text{solve } \phi \approx \mathbf{25^\circ} \quad \text{Ans.}$$

**2.37** The inclined manometer in Fig. P2.37 contains Meriam red oil,  $SG = 0.827$ . Assume the reservoir is very large. If the inclined arm has graduations 1 inch apart, what should  $\theta$  be if each graduation represents 1 psf of the pressure  $p_A$ ?

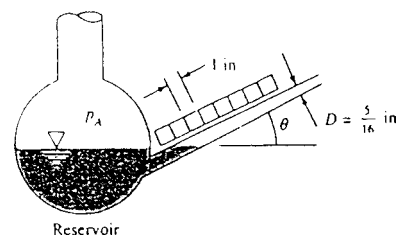


Fig. P2.37

**Solution:** The specific weight of the oil is  $(0.827)(62.4) = 51.6 \text{ lbf/ft}^3$ . If the reservoir level does not change and  $\Delta L = 1$  inch is the scale marking, then

$$p_A(\text{gage}) = 1 \frac{\text{lbf}}{\text{ft}^2} = \gamma_{\text{oil}} \Delta z = \gamma_{\text{oil}} \Delta L \sin \theta = \left( 51.6 \frac{\text{lbf}}{\text{ft}^3} \right) \left( \frac{1}{12} \text{ ft} \right) \sin \theta,$$

or:  $\sin \theta = 0.2325$  or:  $\theta = 13.45^\circ$  Ans.

**2.38** In the figure at right, new tubing contains gas whose density is greater than the outside air. For the dimensions shown, (a) find  $p_1(\text{gage})$ . (b) Find the error caused by assuming  $\rho_{\text{tube}} = \rho_{\text{air}}$ . (c) Evaluate the error if  $\rho_m = 860$ ,  $\rho_a = 1.2$ , and  $\rho_t = 1.5 \text{ kg/m}^3$ ,  $H = 1.32 \text{ m}$ , and  $h = 0.58 \text{ cm}$ .

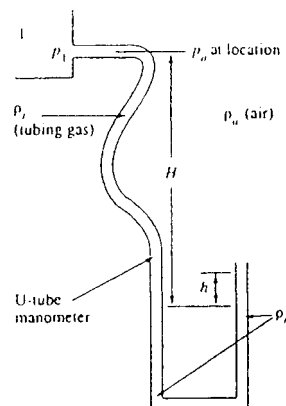


Fig. P2.38

**Solution:** (a) Work hydrostatically around the manometer:

$$p_1 + \rho_t g H = p_a + \rho_m g h + \rho_a g (H - h),$$

or:  $p_{1 \text{ gage}} = (\rho_m - \rho_a) g h - (\rho_t - \rho_a) g H$  Ans. (a)

(b) From (a), the error is the last term: **Error** =  $-(\rho_t - \rho_a) g H$  Ans. (b)

(c) For the given data, the normal reading is  $(860 - 1.2)(9.81)(0.0058) = 48.9 \text{ Pa}$ , and

$$\text{Error} = -(1.50 - 1.20)(9.81)(1.32) = -3.88 \text{ Pa (about 8\%)} \text{ Ans. (c)}$$

**2.39** In Fig. P2.39 the right leg of the manometer is open to the atmosphere. Find the gage pressure, in Pa, in the air gap in the tank. Neglect surface tension.

**Solution:** The two 8-cm legs of air are negligible (only 2 Pa). Begin at the right mercury interface and go to the air gap:

$$\begin{aligned} 0 \text{ Pa-gage} + (133100 \text{ N/m}^3)(0.12 + 0.09 \text{ m}) \\ - (0.8 \times 9790 \text{ N/m}^3)(0.09 - 0.12 - 0.08 \text{ m}) \\ = P_{\text{airgap}} \end{aligned}$$

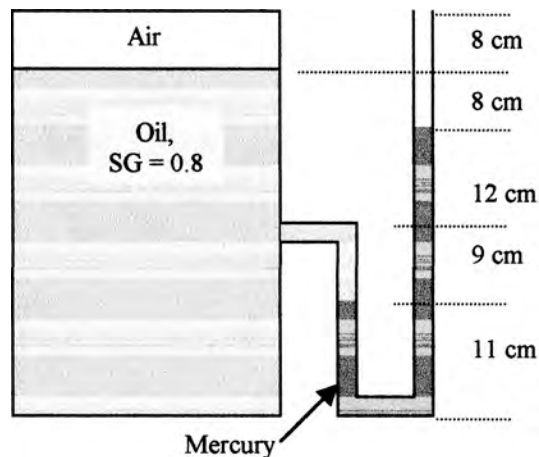


Fig. P2.39

or:  $P_{\text{airgap}} = 27951 \text{ Pa} - 2271 \text{ Pa} \approx \mathbf{25700 \text{ Pa-gage}}$  Ans.

**2.40** In Fig. P2.40 the pressures at A and B are the same, 100 kPa. If water is introduced at A to increase  $p_A$  to 130 kPa, find and sketch the new positions of the mercury menisci. The connecting tube is a uniform 1-cm in diameter. Assume no change in the liquid densities.

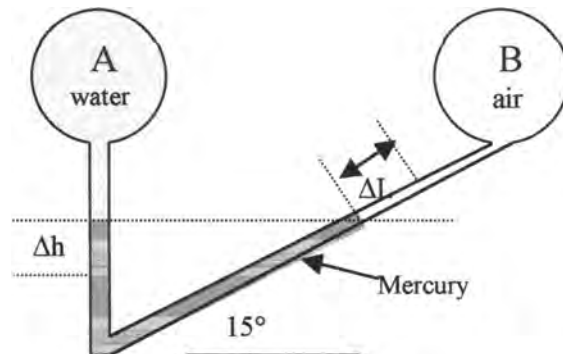


Fig. P2.40

**Solution:** Since the tube diameter is constant, the volume of mercury will displace a distance  $\Delta h$  down the left side, equal to the volume increase on the right side;  $\Delta h = \Delta L$ . Apply the hydrostatic relation to the pressure change, beginning at the right (air/mercury) interface:

$$p_B + \gamma_{\text{Hg}}(\Delta L \sin \theta + \Delta h) - \gamma_{\text{W}}(\Delta h + \Delta L \sin \theta) = p_A \quad \text{with } \Delta h = \Delta L$$

$$\text{or: } 100,000 + 133100(\Delta h)(1 + \sin 15^\circ) - 9790(\Delta h)(1 + \sin 15^\circ) = p_A = 130,000 \text{ Pa}$$

$$\text{Solve for } \Delta h = (30,000 \text{ Pa}) / [(133100 - 9790 \text{ N/m}^2)(1 + \sin 15^\circ)] = \mathbf{0.193 \text{ m}} \quad \text{Ans.}$$

The mercury in the left (vertical) leg will drop 19.3 cm, the mercury in the right (slanted) leg will rise 19.3 cm along the slant and 0.05 cm in vertical elevation.

**2.41** The system in Fig. P2.41 is at 20°C. Determine the pressure at point A in pounds per square foot.

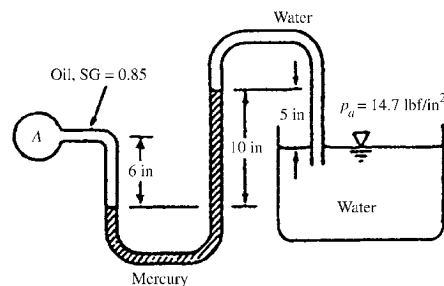


Fig. P2.41

$$p_A + (0.85)(62.4 \text{ lbf/ft}^3) \left( \frac{6}{12} \text{ ft} \right) - (846) \left( \frac{10}{12} \right) + (62.4) \left( \frac{5}{12} \right) = p_{\text{atm}} = (14.7)(144) \frac{\text{lbf}}{\text{ft}^2}$$

$$\text{Solve for } p_A = \mathbf{2770 \text{ lbf/ft}^2} \quad \text{Ans.}$$

**2.42** Small pressure differences can be measured by the two-fluid manometer in Fig. P2.42, where  $\rho_2$  is only slightly larger than  $\rho_1$ . Derive a formula for  $p_A - p_B$  if the reservoirs are very large.

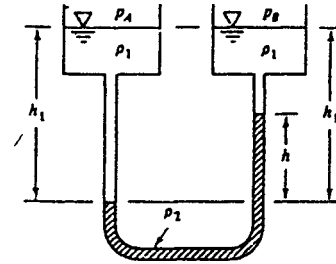


Fig. P2.42

**Solution:** Apply the hydrostatic formula from A to B:

$$p_A + \rho_1 g h_1 - \rho_2 g h - \rho_1 g (h_1 - h) = p_B$$

$$\text{Solve for } p_A - p_B = (\rho_2 - \rho_1) g h \quad \text{Ans.}$$

If  $(\rho_2 - \rho_1)$  is very small,  $h$  will be very large for a given  $\Delta p$  (a sensitive manometer).

**2.43** The traditional method of measuring blood pressure uses a *sphygmomanometer*, first recording the highest (*systolic*) and then the lowest (*diastolic*) pressure from which flowing “Korotkoff” sounds can be heard. Patients with dangerous hypertension can exhibit systolic pressures as high as 5 lbf/in<sup>2</sup>. Normal levels, however, are 2.7 and 1.7 lbf/in<sup>2</sup>, respectively, for systolic and diastolic pressures. The manometer uses mercury and air as fluids. (a) How high should the manometer tube be? (b) Express normal systolic and diastolic blood pressure in millimeters of mercury.

**Solution:** (a) The manometer height must be at least large enough to accommodate the largest systolic pressure expected. Thus apply the hydrostatic relation using 5 lbf/in<sup>2</sup> as the pressure,

$$h = p_B / \rho g = (5 \text{ lbf/in}^2)(6895 \text{ Pa/lbf/in}^2) / (133100 \text{ N/m}^3) = 0.26 \text{ m}$$

$$\text{So make the height about } \mathbf{30 \text{ cm.}} \quad \text{Ans. (a)}$$

(b) Convert the systolic and diastolic pressures by dividing them by mercury’s specific weight.

$$h_{\text{systolic}} = (2.7 \text{ lbf/in}^2)(144 \text{ in}^2/\text{ft}^2) / (846 \text{ lbf/ft}^3) = 0.46 \text{ ft Hg} = 140 \text{ mm Hg}$$

$$h_{\text{diastolic}} = (1.7 \text{ lbf/in}^2)(144 \text{ in}^2/\text{ft}^2) / (846 \text{ lbf/ft}^3) = 0.289 \text{ ft Hg} = 88 \text{ mm Hg}$$

The systolic/diastolic pressures are thus **140/88 mm Hg.** Ans. (b)

**2.44** Water flows downward in a pipe at  $45^\circ$ , as shown in Fig. P2.44. The mercury manometer reads a 6-in height. The pressure drop  $p_2 - p_1$  is partly due to friction and partly due to gravity. Determine the total pressure drop and also the part due to friction only. Which part does the manometer read? Why?

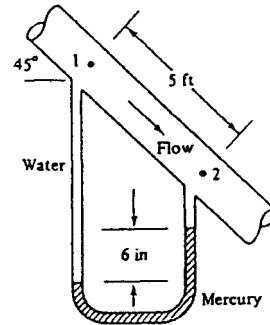


Fig. P2.44

**Solution:** Let “h” be the distance down from point 2 to the mercury-water interface in the right leg. Write the hydrostatic formula from 1 to 2:

$$p_1 + 62.4 \left( 5 \sin 45^\circ + h + \frac{6}{12} \right) - 846 \left( \frac{6}{12} \right) - 62.4h = p_2,$$

$$p_1 - p_2 = \underbrace{(846 - 62.4)(6/12)}_{\dots \text{friction loss} \dots} - \underbrace{62.4(5 \sin 45^\circ)}_{\dots \text{gravity head} \dots} = 392 - 221$$

$$= 171 \frac{\text{lbf}}{\text{ft}^2} \quad \text{Ans.}$$

The manometer reads only the *friction loss* of  $392 \text{ lbf/ft}^2$ , not the gravity head of 221 psf.

**2.45** Determine the gage pressure at point A in Fig. P2.45, in pascals. Is it higher or lower than  $P_{\text{atmosphere}}$ ?

**Solution:** Take  $\gamma = 9790 \text{ N/m}^3$  for water and  $133100 \text{ N/m}^3$  for mercury. Write the hydrostatic formula between the atmosphere and point A:

$$p_{\text{atm}} + (0.85)(9790)(0.4 \text{ m})$$

$$- (133100)(0.15 \text{ m}) - (12)(0.30 \text{ m})$$

$$+ (9790)(0.45 \text{ m}) = p_A,$$

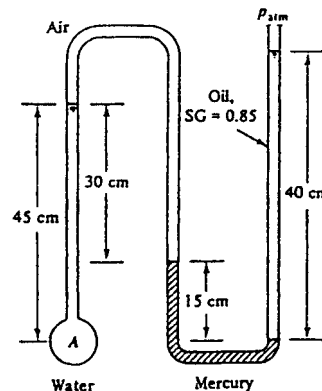


Fig. P2.45

$$\text{or: } p_A = p_{\text{atm}} - 12200 \text{ Pa} = \mathbf{12200 \text{ Pa (vacuum)}} \quad \text{Ans.}$$



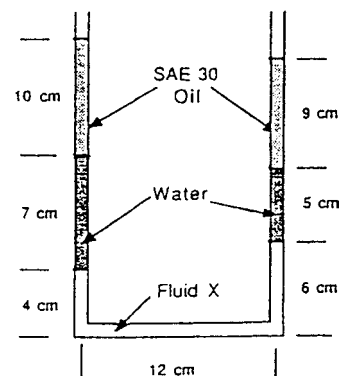
**2.46** In Fig. P2.46 both ends of the manometer are open to the atmosphere. Estimate the specific gravity of fluid X.

**Solution:** The pressure at the bottom of the manometer must be the same regardless of which leg we approach through, left or right:

$$p_{\text{atm}} + (8720)(0.1) + (9790)(0.07) + \gamma_X(0.04) \quad (\text{left leg})$$

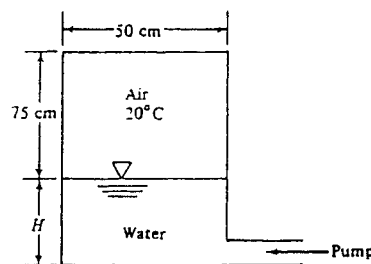
$$= p_{\text{atm}} + (8720)(0.09) + (9790)(0.05) + \gamma_X(0.06) \quad (\text{right leg})$$

$$\text{or: } \gamma_X = 14150 \text{ N/m}^3, \quad SG_X = \frac{14150}{9790} \approx \mathbf{1.45} \quad \text{Ans.}$$



**Fig. P2.46**

**2.47** The cylindrical tank in Fig. P2.47 is being filled with 20°C water by a pump developing an exit pressure of 175 kPa. At the instant shown, the air pressure is 110 kPa and  $H = 35$  cm. The pump stops when it can no longer raise the water pressure. Estimate “H” at that time.



**Fig. P2.47**

**Solution:** At the end of pumping, the bottom water pressure must be 175 kPa:

$$p_{\text{air}} + 9790H = 175000$$

Meanwhile, assuming isothermal air compression, the final air pressure is such that

$$\frac{p_{\text{air}}}{110000} = \frac{\text{Vol}_{\text{old}}}{\text{Vol}_{\text{new}}} = \frac{\pi R^2(0.75 \text{ m})}{\pi R^2(1.1 \text{ m} - H)} = \frac{0.75}{1.1 - H}$$

where  $R$  is the tank radius. Combining these two gives a quadratic equation for  $H$ :

$$\frac{0.75(110000)}{1.1 - H} + 9790H = 175000, \quad \text{or} \quad H^2 - 18.98H + 11.24 = 0$$

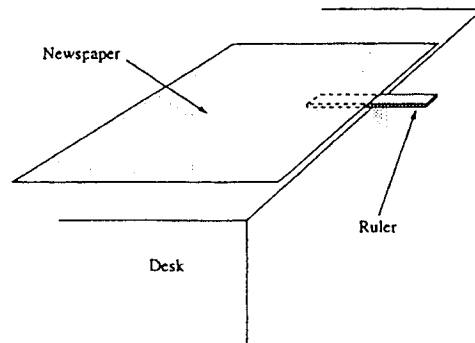
The two roots are  $H = 18.37$  m (ridiculous) or, properly,  $H = \mathbf{0.614 \text{ m}}$  Ans.

**2.48** Conduct an experiment: Place a thin wooden ruler on a table with a 40% overhang, as shown. Cover it with 2 full-size sheets of newspaper. (a) Estimate the total force on top

of the newspaper due to air pressure.  
 (b) With everyone out of the way, perform a karate chop on the outer end of the ruler.  
 (c) Explain the results in b.

*Results:* (a) Newsprint is about 27 in (0.686 m) by 22.5 in (0.572 m). Thus the force is:

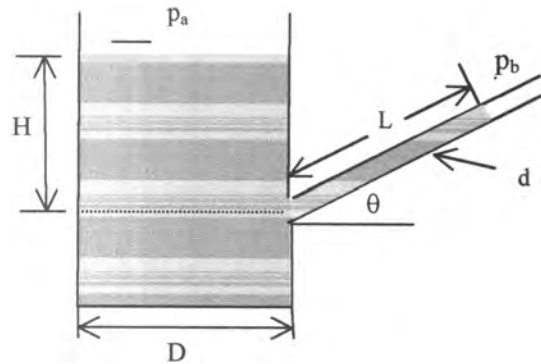
$$F = pA = (101325 \text{ Pa})(0.686 \text{ m})(0.572 \text{ m}) \\ = \mathbf{39700 \text{ N!}} \quad \text{Ans.}$$



**Fig. P2.48**

(b) The newspaper will hold the ruler, which will probably *break* due to the chop. *Ans.*  
 (c) Chop is fast, air does not have time to rush in, partial vacuum under newspaper. *Ans.*

**2.49** An inclined manometer, similar in concept to Fig. P2.37, has a vertical cylinder reservoir whose cross-sectional area is 35 times that of the tube. The fluid is ethylene glycol at 20°C. If  $\theta = 20^\circ$  and the fluid rises 25 cm above its zero-difference level, measured along the slanted tube, what is the actual pressure difference being measured?



**Solution:** The volume of the fluid rising into the tube,  $\pi d^2 \Delta h / 4$ , must equal the volume decrease in the reservoir. Thus H decreases by  $(d/D)^2 \Delta h$  where,

$$\Delta h = L \sin \theta = (0.25 \text{ m}) \sin 20^\circ = 0.0855 \text{ m}$$

$$\Delta H = (d/D)^2 \Delta h = \Delta h / 35 = 0.0024 \text{ m}$$

Applying the hydrostatic relation,

$$p_a + \gamma(-\Delta H) - \gamma \Delta h = p_b$$

$$p_a - p_b = \gamma(\Delta H + \Delta h) = (1117 \text{ kg/m}^3)(9.81 \text{ m/s}^2)(0.0855 \text{ m} + 0.0024 \text{ m}) = 963 \text{ Pa} \\ \Delta p \approx \mathbf{963 \text{ Pa}} \quad \text{Ans.}$$

**2.50** A vat filled with oil (SG = 0.85) is 7 m long and 3 m deep and has a trapezoidal cross-section 2 m wide at the bottom and 4 m wide at the top, as shown in Fig. P2.50. Compute (a) the weight of oil in the vat; (b) the force on the vat bottom; and (c) the force on the trapezoidal end panel.



**Solution:** (a) The total volume of oil in the vat is  $(3\text{ m})(7\text{ m})(4\text{ m} + 2\text{ m})/2 = 63\text{ m}^3$ . Therefore the weight of oil in the vat is

$$W = \gamma_{\text{oil}}(\text{Vol}) = (0.85)(9790\text{ N/m}^3)(63\text{ m}^3) = \mathbf{524,000\text{ N}} \quad \text{Ans. (a)}$$

(b) The force on the horizontal bottom surface of the vat is

$$F_{\text{bottom}} = \gamma_{\text{oil}}h_{\text{CG}}A_{\text{bottom}} = (0.85)(9790)(3\text{ m})(2\text{ m})(7\text{ m}) = \mathbf{350,000\text{ N}} \quad \text{Ans. (b)}$$

Note that  $F$  is less than the total weight of oil—the student might explain why they differ?

(c) I found in my statics book that the centroid of this trapezoid is 1.33 m below the surface, or 1.67 m above the bottom, as shown. Therefore the side-panel force is

$$F_{\text{side}} = \gamma_{\text{oil}}h_{\text{CG}}A_{\text{side}} = (0.85)(9790)(1.33\text{ m})(9\text{ m}^2) = \mathbf{100,000\text{ N}} \quad \text{Ans. (c)}$$

These are large forces. Big vats have to be strong!

**2.51** Gate AB in Fig. P2.51 is 1.2 m long and 0.8 m into the paper. Neglecting atmospheric-pressure effects, compute the force  $F$  on the gate and its center of pressure position  $X$ .

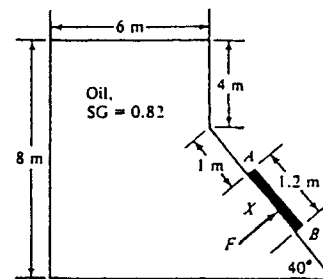


Fig. P2.51

**Solution:** The centroidal depth of the gate is

$$h_{\text{CG}} = 4.0 + (1.0 + 0.6)\sin 40^\circ = 5.028\text{ m},$$

$$\text{hence } F_{\text{AB}} = \gamma_{\text{oil}}h_{\text{CG}}A_{\text{gate}} = (0.82 \times 9790)(5.028)(1.2 \times 0.8) = \mathbf{38750\text{ N}} \quad \text{Ans.}$$

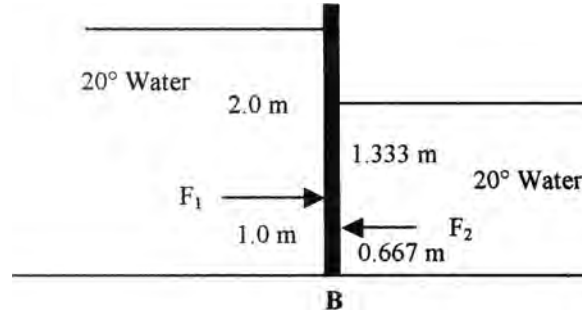
The line of action of  $F$  is slightly below the centroid by the amount

$$y_{\text{CP}} = -\frac{I_{\text{xx}} \sin \theta}{h_{\text{CG}}A} = -\frac{(1/12)(0.8)(1.2)^3 \sin 40^\circ}{(5.028)(1.2 \times 0.8)} = -0.0153\text{ m}$$

Thus the position of the center of pressure is at  $X = 0.6 + 0.0153 \approx \mathbf{0.615\text{ m}}$  Ans.

**2.52** A vertical lock gate is 4 m wide and separates 20°C water levels of 2 m and 3 m, respectively. Find the moment about the bottom required to keep the gate stationary.

**Solution:** On the side of the gate where the water measures 3 m,  $F_1$  acts and has an  $h_{CG}$  of 1.5 m; on the opposite side,  $F_2$  acts with an  $h_{CG}$  of 1 m.



$$F_1 = \gamma h_{CG1} A_1 = (9790)(1.5)(3)(4) = 176,220 \text{ N}$$

$$F_2 = \gamma h_{CG2} A_2 = (9790)(1.0)(2)(4) = 78,320 \text{ N}$$

$$y_{CP1} = [-(1/12)(4)(3)^3 \sin 90^\circ] / [(1.5)(4)(3)] = -0.5 \text{ m}; \text{ so } F_1 \text{ acts at } 1.5 - 0.5 = 1.0 \text{ m above B}$$

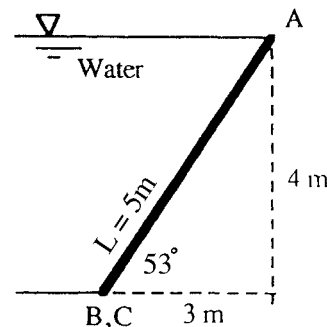
$$y_{CP2} = [-(1/12)(4)(2)^3 \sin 90^\circ] / [(1)(4)(2)] = -0.333 \text{ m}; F_2 \text{ acts at } 1.0 - 0.33 = 0.67 \text{ m above B}$$

Taking moments about points B (see the figure),

$$\begin{aligned} \sum M_B &= (176,220 \text{ N})(1.0 \text{ m}) - (78,320 \text{ N})(0.667 \text{ m}) \\ &= 124,000 \text{ N} \cdot \text{m}; \quad M_{\text{bottom}} = 124 \text{ kN} \cdot \text{m}. \end{aligned}$$

**2.53** Panel ABC in the slanted side of a water tank (shown at right) is an isosceles triangle with vertex at A and base BC = 2 m. Find the water force on the panel and its line of action.

**Solution:** (a) The centroid of ABC is  $2/3$  of the depth down, or  $8/3$  m from the surface. The panel area is  $(1/2)(2 \text{ m})(5 \text{ m}) = 5 \text{ m}^2$ . The water force is



$$F_{ABC} = \gamma h_{CG} A_{\text{panel}} = (9790)(2.67 \text{ m})(5 \text{ m}^2) = 131,000 \text{ N} \quad \text{Ans. (a)}$$

(b) The moment of inertia of ABC is  $(1/36)(2 \text{ m})(5 \text{ m})^3 = 6.94 \text{ m}^4$ . From Eq. (2.44),

$$y_{CP} = -I_{xx} \sin \theta / (h_{CG} A_{\text{panel}}) = -6.94 \sin (53^\circ) / [2.67(5)] = -0.417 \text{ m} \quad \text{Ans. (b)}$$

The center of pressure is 3.75 m down from A, or 1.25 m up from BC.

**2.54** In Fig. P2.54, the hydrostatic force  $F$  is the same on the bottom of all three containers, even though the weights of liquid above are quite different. The three bottom shapes and the fluids are the same. This is called the *hydrostatic paradox*. Explain why it is true and sketch a freebody of each of the liquid columns.

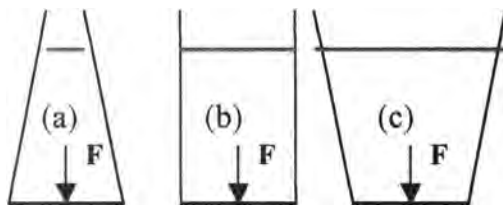
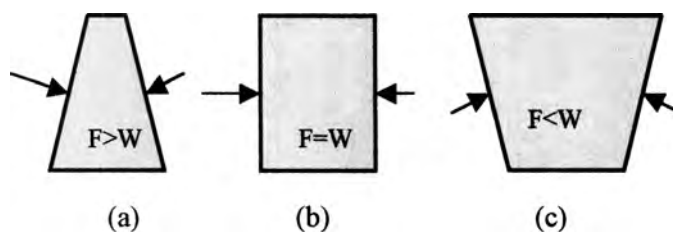


Fig. P2.54

**Solution:** The three freebodies are shown below. Pressure on the side-walls balances the forces. In (a), downward side-pressure components help add to a light  $W$ . In (b) side pressures are horizontal. In (c) upward side pressure helps reduce a heavy  $W$ .



**2.55** Gate AB in Fig. P2.55 is 5 ft wide into the paper, hinged at A, and restrained by a stop at B. Compute (a) the force on stop B; and (b) the reactions at A if  $h = 9.5$  ft.

**Solution:** The centroid of AB is 2.0 ft below A, hence the centroidal depth is  $h + 2 - 4 = 7.5$  ft. Then the total hydrostatic force on the gate is

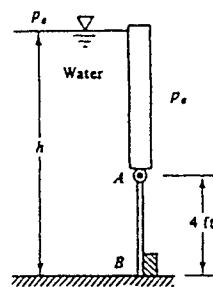


Fig. P2.55

$$F = \gamma h_{CG} A_{\text{gate}} = (62.4 \text{ lbf/ft}^3)(7.5 \text{ ft})(20 \text{ ft}^2) = 9360 \text{ lbf}$$

The C.P. is below the centroid by the amount

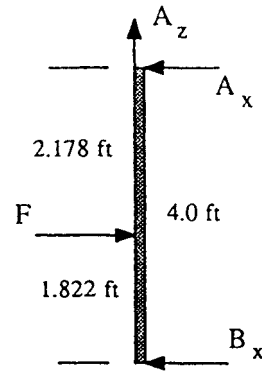
$$y_{CP} = -\frac{I_{xx} \sin \theta}{h_{CG} A} = \frac{(1/12)(5)(4)^3 \sin 90^\circ}{(7.5)(20)}$$

$$= -0.178 \text{ ft}$$

This is shown on the freebody of the gate at right. We find force  $B_x$  with moments about A:

$$\sum M_A = B_x(4.0) - (9360)(2.178) = 0,$$

$$\text{or: } B_x = \mathbf{5100 \text{ lbf}} \quad (\text{to left}) \quad \text{Ans. (a)}$$



The reaction forces at A then follow from equilibrium of forces (with *zero* gate weight):

$$\sum F_x = 0 = 9360 - 5100 - A_x, \quad \text{or: } A_x = \mathbf{4260 \text{ lbf}} \quad (\text{to left})$$

$$\sum F_z = 0 = A_z + W_{\text{gate}} \approx A_z, \quad \text{or: } A_z = \mathbf{0 \text{ lbf}} \quad \text{Ans. (b)}$$

**2.56** For the gate of Prob. 2.55 above, stop “B” breaks if the force on it equals 9200 lbf. For what water depth  $h$  is this condition reached?

**Solution:** The formulas must be written in terms of the unknown centroidal depth:

$$h_{CG} = h - 2 \quad F = \gamma h_{CG} A = (62.4)h_{CG}(20) = 1248h_{CG}$$

$$y_{CP} = -\frac{I_{xx} \sin \theta}{h_{CG} A} = -\frac{(1/12)(5)(4)^3 \sin 90^\circ}{h_{CG}(20)} = -\frac{1.333}{h_{CG}}$$

Then moments about A for the freebody in Prob. 2.155 above will yield the answer:

$$\sum M_A = 0 = 9200(4) - (1248h_{CG}) \left( 2 + \frac{1.333}{h_{CG}} \right), \quad \text{or } h_{CG} = 14.08 \text{ ft}, \quad h = \mathbf{16.08 \text{ ft}} \quad \text{Ans.}$$

**2.57** The tank in Fig. P2.57 is 2 m wide into the paper. Neglecting atmospheric pressure, find the resultant hydrostatic force on panel BC, (a) from a single formula; (b) by computing horizontal and vertical forces separately, in the spirit of curved surfaces.

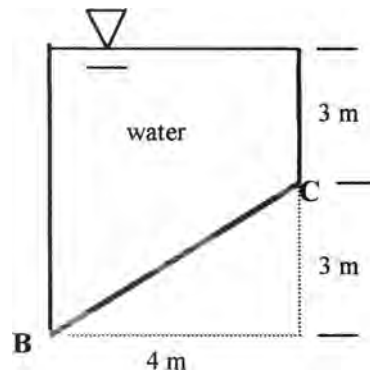


Fig. P2.57

**Solution:** (a) The resultant force  $F$ , may be found by simply applying the hydrostatic relation

$$F = \gamma h_{CG} A = (9790 \text{ N/m}^3)(3 + 1.5 \text{ m})(5 \text{ m} \times 2 \text{ m}) = 440,550 \text{ N} = \mathbf{441 \text{ kN}} \quad \text{Ans. (a)}$$

(b) The horizontal force acts as though BC were vertical, thus  $h_{CG}$  is halfway down from C and acts on the projected area of BC.

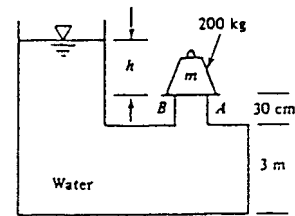
$$F_H = (9790)(4.5)(3 \times 2) = 264,330 \text{ N} = \mathbf{264 \text{ kN}} \quad \text{Ans. (b)}$$

The vertical force is equal to the weight of fluid above BC,

$$F_V = (9790)[(3)(4) + (1/2)(4)(3)](2) = 352,440 = \mathbf{352 \text{ kN}} \quad \text{Ans. (b)}$$

The resultant is the same as part (a):  $F = [(264)^2 + (352)^2]^{1/2} = \mathbf{441 \text{ kN}}$ .

**2.58** In Fig. P2.58, weightless cover gate AB closes a circular opening 80 cm in diameter when weighed down by the 200-kg mass shown. What water level  $h$  will dislodge the gate?



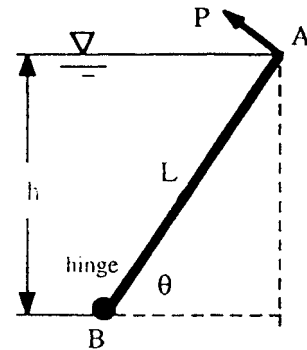
**Fig. P2.58**

**Solution:** The centroidal depth is exactly equal to  $h$  and force  $F$  will be upward on the gate. Dislodging occurs when  $F$  equals the weight:

$$F = \gamma h_{CG} A_{\text{gate}} = (9790 \text{ N/m}^3) h \frac{\pi}{4} (0.8 \text{ m})^2 = W = (200)(9.81) \text{ N}$$

$$\text{Solve for } h = \mathbf{0.40 \text{ m}} \quad \text{Ans.}$$

**2.59** Gate AB has length  $L$ , width  $b$  into the paper, is hinged at B, and has negligible weight. The liquid level  $h$  remains at the top of the gate for any angle  $\theta$ . Find an analytic expression for the force  $P$ , perpendicular to AB, required to keep the gate in equilibrium.



**Solution:** The centroid of the gate remains at distance  $L/2$  from A and depth  $h/2$  below

the surface. For any  $\theta$ , then, the hydrostatic force is  $F = \gamma(h/2)Lb$ . The moment of inertia of the gate is  $(1/12)bL^3$ , hence  $y_{CP} = -(1/12)bL^3 \sin\theta / [(h/2)Lb]$ , and the center of pressure is  $(L/2 - y_{CP})$  from point B. Summing moments about hinge B yields

$$PL = F(L/2 - y_{CP}), \quad \text{or: } \mathbf{P = (\gamma hb/4)(L - L^2 \sin \theta/3h)} \quad \text{Ans.}$$

**2.60** The pressure in the air gap is 8000 Pa gage. The tank is cylindrical. Calculate the net hydrostatic force (a) on the bottom of the tank; (b) on the cylindrical sidewall CC; and (c) on the annular plane panel BB.

**Solution:** (a) The bottom force is simply equal to bottom pressure times bottom area:

$$\begin{aligned} p_{\text{bottom}} &= p_{\text{air}} + \rho_{\text{water}} g |\Delta z| = 8000 \text{ Pa} \\ &\quad + (9790 \text{ N/m}^3)(0.25 + 0.12 \text{ m}) \\ &= 11622 \text{ Pa-gage} \end{aligned}$$

$$F_{\text{bottom}} = p_{\text{bottom}} A_{\text{bottom}} = (11622 \text{ Pa})(\pi/4)(0.36 \text{ m})^2 = \mathbf{1180 \text{ N}} \quad \text{Ans. (a)}$$

(b) The net force on the cylindrical sidewall CC is **zero** due to symmetry. *Ans. (b)*

(c) The force on annular region CC is, like part (a), the pressure at CC times the area of CC:

$$p_{CC} = p_{\text{air}} + \rho_{\text{water}} g |\Delta z|_{CC} = 8000 \text{ Pa} + (9790 \text{ N/m}^3)(0.25 \text{ m}) = 10448 \text{ Pa-gage}$$

$$F_{CC} = p_{CC} A_{CC} = (10448 \text{ Pa})(\pi/4)[(0.36 \text{ m})^2 - (0.16 \text{ m})^2] = \mathbf{853 \text{ N}} \quad \text{Ans. (c)}$$

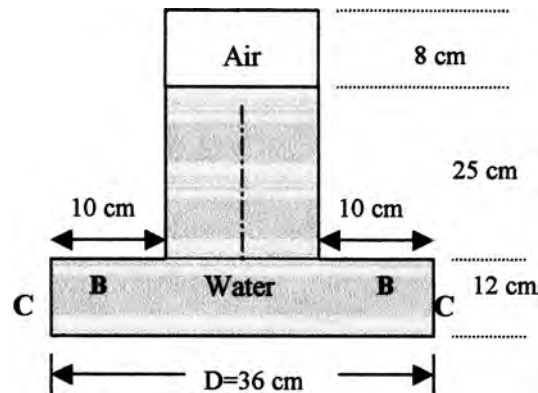


Fig. P2.60

**2.61** Gate AB in Fig. P2.61 is a homogeneous mass of 180 kg, 1.2 m wide into the paper, resting on smooth bottom B. All fluids are at 20°C. For what water depth  $h$  will the force at point B be zero?

**Solution:** Let  $\gamma = 12360 \text{ N/m}^3$  for glycerin and  $9790 \text{ N/m}^3$  for water. The centroid of

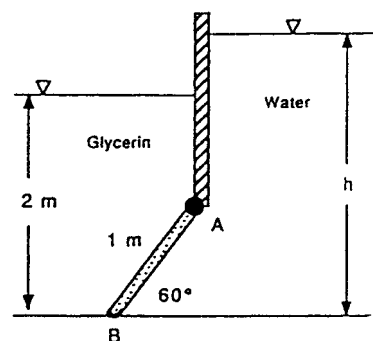


Fig. P2.61

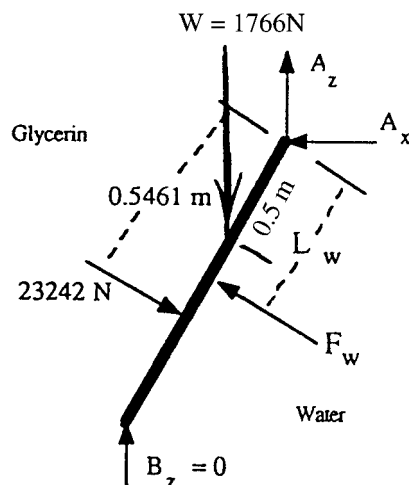


AB is 0.433 m vertically below A, so  $h_{CG} = 2.0 - 0.433 = 1.567$  m, and we may compute the glycerin force and its line of action:

$$F_g = \gamma \bar{h} A = (12360)(1.567)(1.2) = 23242 \text{ N}$$

$$y_{CP,g} = -\frac{(1/12)(1.2)(1)^3 \sin 60^\circ}{(1.567)(1.2)} = -0.0461 \text{ m}$$

These are shown on the freebody at right. The water force and its line of action are shown without numbers, because they depend upon the centroidal depth on the water side:



$$F_w = (9790)h_{CG}(1.2)$$

$$y_{CP} = -\frac{(1/12)(1.2)(1)^3 \sin 60^\circ}{h_{CG}(1.2)} = -\frac{0.0722}{h_{CG}}$$

The weight of the gate,  $W = 180(9.81) = 1766$  N, acts at the centroid, as shown above. Since the force at B equals zero, we may sum moments counterclockwise about A to find the water depth:

$$\begin{aligned} \sum M_A = 0 &= (23242)(0.5461) + (1766)(0.5 \cos 60^\circ) \\ &\quad - (9790)h_{CG}(1.2)(0.5 + 0.0722/h_{CG}) \end{aligned}$$

$$\text{Solve for } h_{CG, \text{water}} = 2.09 \text{ m, or: } h = h_{CG} + 0.433 = \mathbf{2.52 \text{ m}} \text{ Ans.}$$

**2.62** Gate AB in Fig. P2.62 is 15 ft long and 8 ft wide into the paper, hinged at B with a stop at A. The gate is 1-in-thick steel,  $SG = 7.85$ . Compute the  $20^\circ\text{C}$  water level  $h$  for which the gate will start to fall.

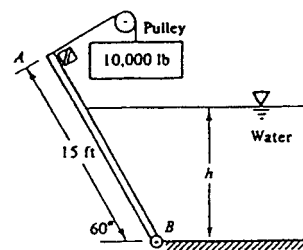
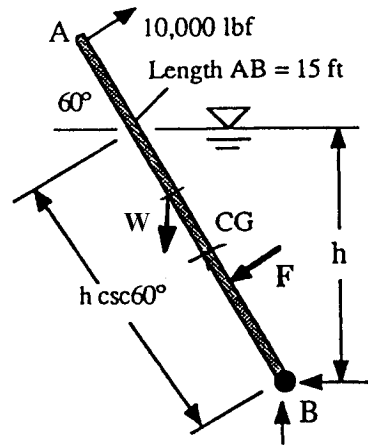


Fig. P2.62

**Solution:** Only the length ( $h \csc 60^\circ$ ) of the gate lies below the water. Only this part

contributes to the hydrostatic force shown in the freebody at right:

$$\begin{aligned}
 F &= \gamma h_{CG} A = (62.4) \left( \frac{h}{2} \right) (8h \csc 60^\circ) \\
 &= 288.2h^2 \text{ (lbf)} \\
 y_{CP} &= -\frac{(1/12)(8)(h \csc 60^\circ)^3 \sin 60^\circ}{(h/2)(8h \csc 60^\circ)} \\
 &= -\frac{h}{6} \csc 60^\circ
 \end{aligned}$$



The weight of the gate is  $(7.85)(62.4 \text{ lbf/ft}^3)(15 \text{ ft})(1/12 \text{ ft})(8 \text{ ft}) = 4898 \text{ lbf}$ . This weight acts downward at the CG of the *full gate* as shown (not the CG of the submerged portion). Thus,  $W$  is 7.5 ft above point  $B$  and has moment arm  $(7.5 \cos 60^\circ \text{ ft})$  about  $B$ .

We are now in a position to find  $h$  by summing moments about the hinge line  $B$ :

$$\begin{aligned}
 \sum M_B &= (10000)(15) - (288.2h^2)[(h/2) \csc 60^\circ - (h/6) \csc 60^\circ] - 4898(7.5 \cos 60^\circ) = 0, \\
 \text{or: } 110.9h^3 &= 150000 - 18369, \quad h = (131631/110.9)^{1/3} = \mathbf{10.6 \text{ ft}} \quad \text{Ans.}
 \end{aligned}$$

**2.63** The tank in Fig. P2.63 has a 4-cm-diameter plug which will pop out if the hydrostatic force on it reaches 25 N. For  $20^\circ\text{C}$  fluids, what will be the reading  $h$  on the manometer when this happens?

**Solution:** The water depth when the plug pops out is

$$F = 25 \text{ N} = \gamma h_{CG} A = (9790) h_{CG} \frac{\pi(0.04)^2}{4}$$

$$\text{or } h_{CG} = 2.032 \text{ m}$$

It makes little numerical difference, but the mercury-water interface is a little deeper than this, by the amount  $(0.02 \sin 50^\circ)$  of plug-depth, plus 2 cm of tube length. Thus

$$p_{\text{atm}} + (9790)(2.032 + 0.02 \sin 50^\circ + 0.02) - (133100)h = p_{\text{atm}}$$

$$\text{or: } h \approx \mathbf{0.152 \text{ m}} \quad \text{Ans.}$$

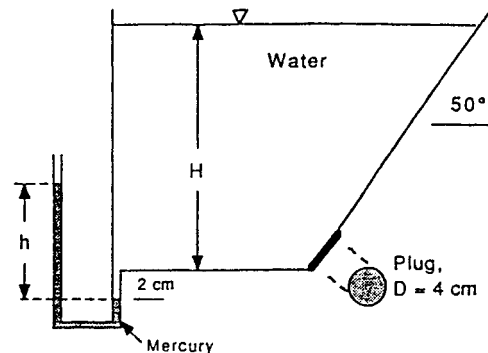


Fig. P2.63

**2.64** Gate ABC in Fig. P2.64 has a fixed hinge at B and is 2 m wide into the paper. If the water level is high enough, the gate will open. Compute the depth  $h$  for which this happens.

**Solution:** Let  $H = (h - 1 \text{ meter})$  be the depth down to the level AB. The forces on AB and BC are shown in the freebody at right. The moments of these forces about B are equal when the gate opens:

$$\begin{aligned}\sum M_B = 0 &= \gamma H(0.2)b(0.1) \\ &= \gamma \left(\frac{H}{2}\right)(Hb) \left(\frac{H}{3}\right)\end{aligned}$$

$$\begin{aligned}\text{or: } H &= 0.346 \text{ m,} \\ h &= H + 1 = \mathbf{1.346 \text{ m}} \quad \text{Ans.}\end{aligned}$$

This solution is independent of both the water density and the gate width  $b$  into the paper.

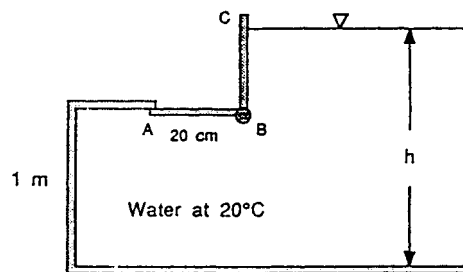
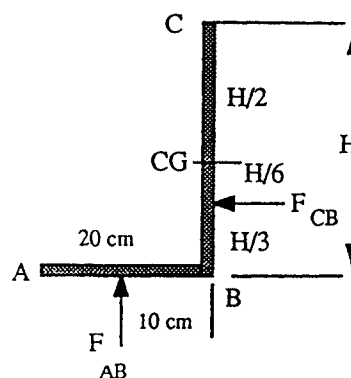


Fig. P2.64



**2.65** Gate AB in Fig. P2.65 is semi-circular, hinged at B, and held by a horizontal force  $P$  at point A. Determine the required force  $P$  for equilibrium.

**Solution:** The centroid of a semi-circle is at  $4R/3\pi \approx 1.273 \text{ m}$  off the bottom, as shown in the sketch at right. Thus it is  $3.0 - 1.273 = 1.727 \text{ m}$  down from the force  $P$ . The water force  $F$  is

$$\begin{aligned}F &= \gamma h_{CG} A = (9790)(5.0 + 1.727) \frac{\pi}{2} (3)^2 \\ &= 931000 \text{ N}\end{aligned}$$

The line of action of  $F$  lies below the CG:

$$y_{CP} = -\frac{I_{xx} \sin \theta}{h_{CG} A} = -\frac{(0.10976)(3)^4 \sin 90^\circ}{(5 + 1.727)(\pi/2)(3)^2} = -0.0935 \text{ m}$$

Then summing moments about B yields the proper support force  $P$ :

$$\sum M_B = 0 = (931000)(1.273 - 0.0935) - 3P, \quad \text{or: } P = \mathbf{366000 \text{ N}} \quad \text{Ans.}$$

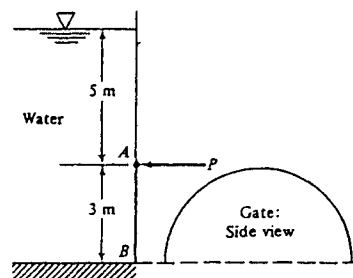
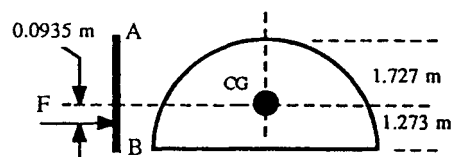


Fig. P2.65



**2.66** Dam ABC in Fig. P2.66 is 30 m wide into the paper and is concrete (SG  $\approx 2.40$ ). Find the hydrostatic force on surface AB and its moment about C. Could this force tip the dam over? Would fluid seepage under the dam change your argument?

**Solution:** The centroid of surface AB is 40 m deep, and the total force on AB is

$$F = \gamma h_{CG} A = (9790)(40)(100 \times 30) = 1.175E9 \text{ N}$$

The line of action of this force is two-thirds of the way down along AB, or 66.67 m from A. This is seen either by inspection (A is at the surface) or by the usual formula:

$$y_{CP} = -\frac{I_{xx} \sin \theta}{h_{CG} A} = -\frac{(1/12)(30)(100)^3 \sin(53.13^\circ)}{(40)(30 \times 100)} = -16.67 \text{ m}$$

to be added to the 50-m distance from A to the centroid, or  $50 + 16.67 = 66.67$  m. As shown in the figure, the line of action of F is 2.67 m to the left of a line up from C normal to AB. The moment of F about C is thus

$$M_C = FL = (1.175E9)(66.67 - 64.0) \approx 3.13E9 \text{ N}\cdot\text{m} \quad \text{Ans.}$$

*This moment is counterclockwise, hence it cannot tip over the dam.* If there were seepage under the dam, the main support force at the bottom of the dam would shift to the left of point C and might indeed cause the dam to tip over.

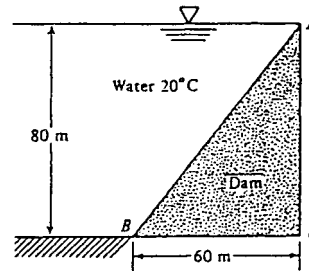
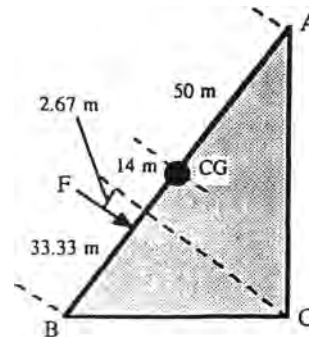


Fig. P2.66



**2.67** Generalize Prob. 2.66 with length AB as “H”, length BC as “L”, and angle ABC as “ $q$ ”, with width “b” into the paper. If the dam material has specific gravity “SG”, with no seepage, find the critical angle  $\theta_c$  for which the dam will just tip over to the right. Evaluate this expression for SG = 2.40.

**Solution:** By geometry,  $L = H \cos \theta$  and the vertical height of the dam is  $H \sin \theta$ . The

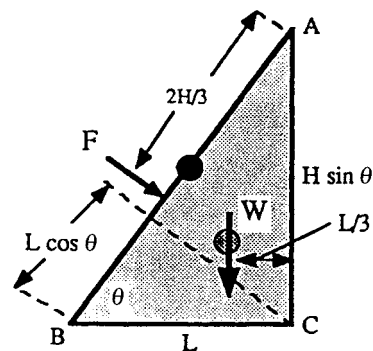


Fig. P2.67

force  $F$  on surface  $AB$  is  $\gamma(H/2)(\sin\theta)Hb$ , and its position is at  $2H/3$  down from point  $A$ , as shown in the figure. Its moment arm about  $C$  is thus  $(H/3 - L\cos\theta)$ . Meanwhile the weight of the dam is  $W = (SG)\gamma(L/2)H(\sin\theta)b$ , with a moment arm  $L/3$  as shown. Then summation of clockwise moments about  $C$  gives, for critical “tip-over” conditions,

$$\Sigma M_C = 0 = \left( \gamma \frac{H}{2} \sin \theta H b \right) \left[ \frac{H}{3} - L \cos \theta \right] - \left[ SG(\gamma) \frac{L}{2} H \sin \theta b \right] \left( \frac{L}{3} \right) \quad \text{with } L = H \cos \theta.$$

$$\text{Solve for } \cos^2 \theta_c = \frac{1}{3 + SG} \quad \text{Ans.}$$

Any angle greater than  $\theta_c$  will cause tip-over to the right. For the particular case of concrete,  $SG \approx 2.40$ ,  $\cos \theta_c \approx 0.430$ , or  $\theta_c \approx 64.5^\circ$ , which is greater than the given angle  $\theta = 53.13^\circ$  in Prob. 2.66, hence there was no tipping in that problem.

**2.68** Isosceles triangle gate  $AB$  in Fig. P2.68 is hinged at  $A$  and weighs  $1500 \text{ N}$ . What horizontal force  $P$  is required at point  $B$  for equilibrium?

**Solution:** The gate is  $2.0/\sin 50^\circ = 2.611 \text{ m}$  long from  $A$  to  $B$  and its area is  $1.3054 \text{ m}^2$ . Its centroid is  $1/3$  of the way down from  $A$ , so the centroidal depth is  $3.0 + 0.667 \text{ m}$ . The force on the gate is

$$F = \gamma h_{CG} A = (0.83)(9790)(3.667)(1.3054) = 38894 \text{ N}$$

The position of this force is below the centroid:

$$y_{CP} = -\frac{I_{xx} \sin \theta}{h_{CG} A}$$

$$= -\frac{(1/36)(1.0)(2.611)^3 \sin 50^\circ}{(3.667)(1.3054)} = -0.0791 \text{ m}$$

The force and its position are shown in the freebody at upper right. The gate weight of  $1500 \text{ N}$  is assumed at the centroid of the plate, with moment arm  $0.559$  meters about point  $A$ . Summing moments about point  $A$  gives the required force  $P$ :

$$\Sigma M_A = 0 = P(2.0) + 1500(0.559) - 38894(0.870 + 0.0791),$$

$$\text{Solve for } P = 18040 \text{ N} \quad \text{Ans.}$$

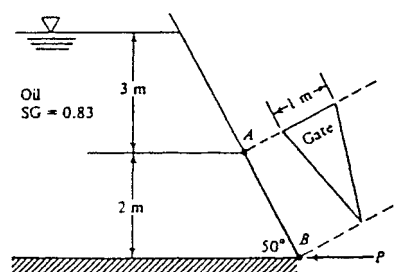
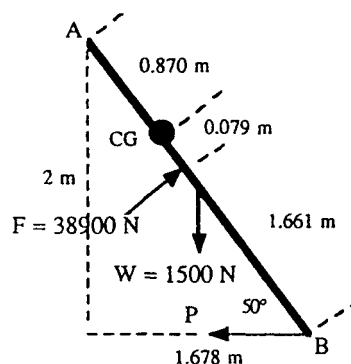


Fig. P2.68



**2.69** Panel BCD is semicircular and line BC is 8 cm below the surface. Determine (a) the hydrostatic force on the panel; and (b) the moment of this force about D.

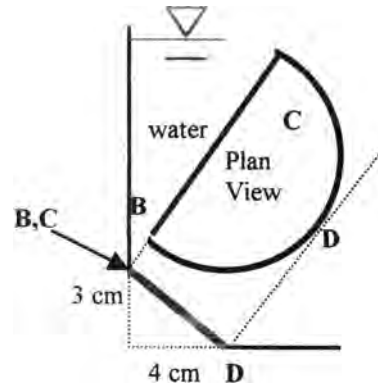
**Solution:** (a) The radius of BCD is 5 cm. Its centroid is at  $4R/3\pi$  or  $4(5 \text{ cm})/3\pi = 2.12 \text{ cm}$  down along the slant from BC to D. Then the vertical distance down to the centroid is  $h_{CG} = 8 \text{ cm} + (2.12 \text{ cm}) \cos(53.13^\circ) = 9.27 \text{ cm}$ .

The force is the centroidal pressure times the panel area:

$$F = \gamma h_{CG} A = (9790 \text{ N/m}^3)(0.0927 \text{ m})(\pi/2)(0.05 \text{ m})^2 = \mathbf{3.57 \text{ N}} \quad \text{Ans. (a)}$$

(b) Point D is  $(0.05 - 0.0212) = 0.288 \text{ cm}$  from the centroid. The moment of F about D is thus

$$M_D = (3.57 \text{ N})(0.05 \text{ m} - 0.0212 \text{ m}) = \mathbf{0.103 \text{ N} \cdot \text{m}} \quad \text{Ans. (b)}$$

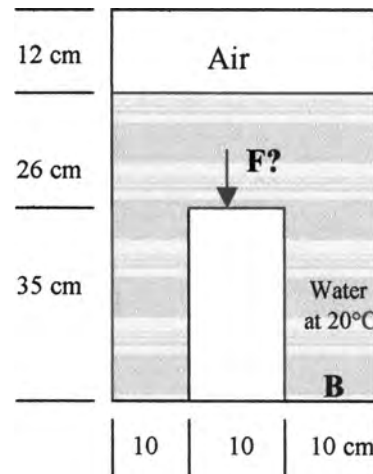


**Fig. P2.69**

**2.70** The cylindrical tank in Fig. P2.70 has a 35-cm-high cylindrical insert in the bottom. The pressure at point B is 156 kPa. Find (a) the pressure in the air space; and (b) the force on the top of the insert. Neglect air pressure outside the tank.

**Solution:** (a) The pressure in the air space can be found by working upwards hydrostatically from point B:

$$156,000 \text{ Pa} - (9790 \text{ N/m}^3)(0.35 + 0.26 \text{ m}) \\ = p_{\text{air}} \approx 150,000 \text{ Pa} = \mathbf{150 \text{ kPa}} \quad \text{Ans. (a)}$$



**Fig. P2.70**

(b) The force on top of the insert is simply the pressure on the insert times the insert area:

$$p_{\text{insert top}} = 156,000 \text{ Pa} - (9790 \text{ N/m}^3)(0.35 \text{ m}) = 152,600 \text{ Pa} \\ F_{\text{insert}} = p_{\text{insert}} A_{\text{insert}} = (152600 \text{ Pa})(\pi/4)(0.1 \text{ m})^2 = \mathbf{1200 \text{ N}} \quad \text{Ans. (b)}$$

**2.71** In Fig. P2.71 gate AB is 3 m wide into the paper and is connected by a rod and pulley to a concrete sphere (SG = 2.40). What sphere diameter is just right to close the gate?

**Solution:** The centroid of AB is 10 m down from the surface, hence the hydrostatic force is

$$F = \gamma h_{CG} A = (9790)(10)(4 \times 3) = 1.175E6 \text{ N}$$

The line of action is slightly below the centroid:

$$y_{CP} = -\frac{(1/12)(3)(4)^3 \sin 90^\circ}{(10)(12)} = -0.133 \text{ m}$$

Sum moments about B in the freebody at right to find the pulley force or weight W:

$$\sum M_B = 0 = W(6 + 8 + 4 \text{ m}) - (1.175E6)(2.0 - 0.133 \text{ m}), \text{ or } W = 121800 \text{ N}$$

Set this value equal to the weight of a solid concrete sphere:

$$W = 121800 \text{ N} = \gamma_{\text{concrete}} \frac{\pi}{6} D^3 = (2.4)(9790) \frac{\pi}{6} D^3, \text{ or: } D_{\text{sphere}} = 2.15 \text{ m } \textit{Ans.}$$

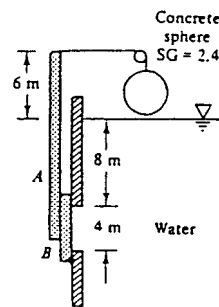
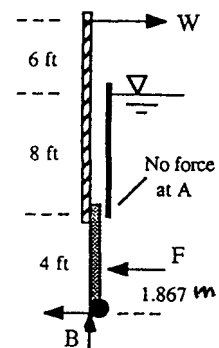


Fig. P2.71



**2.72** Gate B is 30 cm high and 60 cm wide into the paper and hinged at the top. What is the water depth  $h$  which will first cause the gate to open?

**Solution:** The minimum height needed to open the gate can be assessed by calculating the hydrostatic force on each side of the gate and equating moments about the hinge. The air pressure causes a force,  $F_{\text{air}}$ , which acts on the gate at 0.15 m above point D.

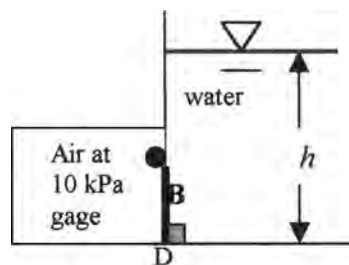


Fig. P2.72

$$F_{\text{air}} = (10,000 \text{ Pa})(0.3 \text{ m})(0.6 \text{ m}) = 1800 \text{ N}$$

Since the air pressure is uniform,  $F_{\text{air}}$  acts at the centroid of the gate, or 15 cm below the hinge. The force imparted by the water is simply the hydrostatic force,

$$F_w = (\gamma h_{\text{CG}} A)_w = (9790 \text{ N/m}^3)(h - 0.15 \text{ m})(0.3 \text{ m})(0.6 \text{ m}) = 1762.2h - 264.3$$

This force has a center of pressure at,

$$y_{\text{CP}} = \frac{\frac{1}{12}(0.6)(0.3)^3(\sin 90)}{(h - 0.15)(0.3)(0.6)} = \frac{0.0075}{h - 0.15} \quad \text{with } h \text{ in meters}$$

Sum moments about the hinge and set equal to zero to find the minimum height:

$$\sum M_{\text{hinge}} = 0 = (1762.2h - 264.3)[0.15 + (0.0075/(h - 0.15))] - (1800)(0.15)$$

This is quadratic in  $h$ , but let's simply solve by iteration:  $h = 1.12 \text{ m}$  Ans.

**2.73** Weightless gate AB is 5 ft wide into the paper and opens to let fresh water out when the ocean tide is falling. The hinge at A is 2 ft above the freshwater level. Find  $h$  when the gate opens.

**Solution:** There are two different hydrostatic forces and two different lines of action. On the water side,

$$F_w = \gamma h_{\text{CG}} A = (62.4)(5)(10 \times 5) = 15600 \text{ lbf}$$

positioned at 3.33 ft above point B. In the seawater,

$$\begin{aligned} F_s &= (1.025 \times 62.4) \left( \frac{h}{2} \right) (5h) \\ &= 159.9h^2 \text{ (lbf)} \end{aligned}$$

positioned at  $h/3$  above point B. Summing moments about hinge point A gives the desired seawater depth  $h$ :

$$\begin{aligned} \sum M_A = 0 &= (159.9h^2)(12 - h/3) - (15600)(12 - 3.33), \\ \text{or } 53.3h^3 - 1918.8h^2 + 135200 &= 0, \quad \text{solve for } h = \mathbf{9.85 \text{ ft}} \quad \text{Ans.} \end{aligned}$$

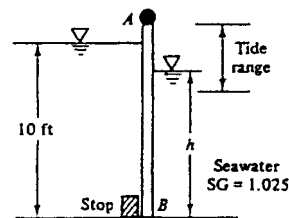
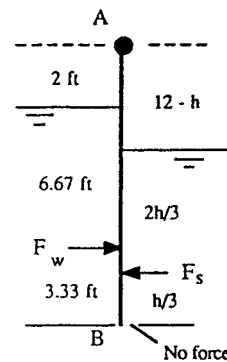


Fig. P2.73





**2.74** Find the height  $H$  in Fig. P2.74 for which the hydrostatic force on the rectangular panel is the same as the force on the semicircular panel below. Find the force on each panel and set them equal:

$$F_{\text{rect}} = \gamma h_{\text{CG}} A_{\text{rect}} = \gamma(H/2)[(2R)(H)] = \gamma R H^2$$

$$F_{\text{semi}} = \gamma h_{\text{CG}} A_{\text{semi}} = \gamma(H + 4R/3\pi)[(\pi/2)R^2]$$

Set them equal, cancel  $\gamma$ :  $RH^2 = (\pi/2)R^2H + 2R^3/3$ , or:  $H^2 - (\pi/2)RH - 2R^2/3 = 0$

**Solution:**  $H = R[\pi/4 + \{(\pi/4)^2 + 2/3\}^{1/2}] \approx 1.92R$  Ans.

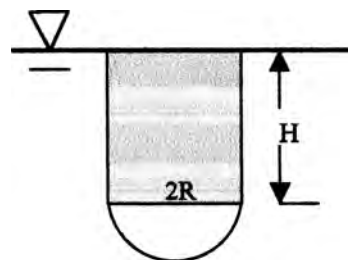


Fig. P2.74

**2.75** Gate AB in the figure is hinged at A, has width  $b$  into the paper, and makes smooth contact at B. The gate has density  $\rho_s$  and uniform thickness  $t$ . For what gate density, expressed as a function of  $(h, t, \rho, \theta)$ , will the gate just begin to lift off the bottom? Why is your answer independent of  $L$  and  $b$ ?

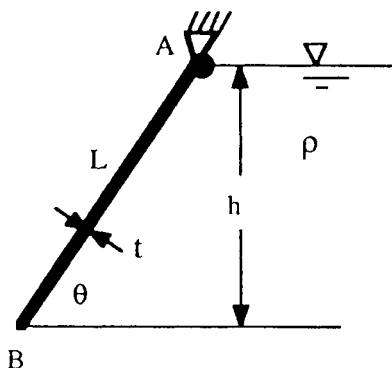


Fig. P2.75

**Solution:** Gate weight acts down at the center between A and B. The hydrostatic force acts at two-thirds of the way down the gate from A. When “beginning to lift off,” there is no force at B. Summing moments about A yields

$$W \frac{L}{2} \cos\theta = F \frac{2L}{3}, \quad F = \rho g \frac{h}{2} bL, \quad W = \rho_s g bL t$$

Combine and solve for the density of the gate.  $L$  and  $b$  and  $g$  drop out!

$$\rho_s = \frac{2h}{3t \cos\theta} \rho \quad \text{Ans.}$$

**2.76** Panel BC in Fig. P2.76 is circular. Compute (a) the hydrostatic force of the water on the panel; (b) its center of pressure; and (c) the moment of this force about point B.

**Solution:** (a) The hydrostatic force on the gate is:

$$\begin{aligned} F &= \gamma h_{CG} A \\ &= (9790 \text{ N/m}^3)(4.5 \text{ m}) \sin 50^\circ (\pi)(1.5 \text{ m})^2 \\ &= \mathbf{239 \text{ kN}} \quad \text{Ans. (a)} \end{aligned}$$

(b) The center of pressure of the force is:

$$\begin{aligned} y_{CP} &= \frac{I_{xx} \sin \theta}{h_{CG} A} = \frac{\frac{\pi}{4} r^4 \sin \theta}{h_{CG} A} \\ &= \frac{\frac{\pi}{4} (1.5)^4 \sin 50^\circ}{(4.5 \sin 50^\circ) (\pi)(1.5^2)} = \mathbf{0.125 \text{ m}} \quad \text{Ans. (b)} \end{aligned}$$

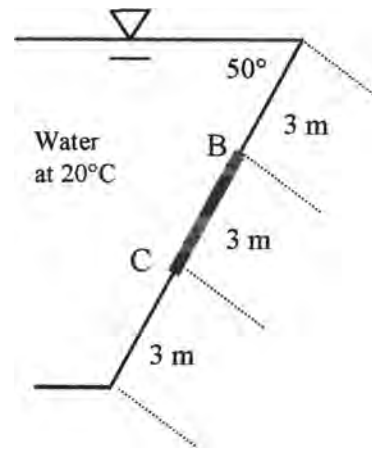


Fig. P2.76

Thus  $y$  is **1.625 m** down along the panel from B (or 0.125 m down from the center of the circle).

(c) The moment about B due to the hydrostatic force is,

$$M_B = (238550 \text{ N})(1.625 \text{ m}) = 387,600 \text{ N} \cdot \text{m} = \mathbf{388 \text{ kN} \cdot \text{m}} \quad \text{Ans. (c)}$$

**2.77** Circular gate ABC is hinged at B. Compute the force just sufficient to keep the gate from opening when  $h = 8 \text{ m}$ . Neglect atmospheric pressure.

**Solution:** The hydrostatic force on the gate is

$$\begin{aligned} F &= \gamma h_{CG} A = (9790)(8 \text{ m})(\pi \text{ m}^2) \\ &= 246050 \text{ N} \end{aligned}$$

This force acts below point B by the distance

$$y_{CP} = -\frac{I_{xx} \sin \theta}{h_{CG} A} = -\frac{(\pi/4)(1)^4 \sin 90^\circ}{(8)(\pi)} = -0.03125 \text{ m}$$

Summing moments about B gives  $P(1 \text{ m}) = (246050)(0.03125 \text{ m})$ , or  $P \approx \mathbf{7690 \text{ N}}$  Ans.

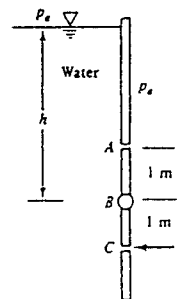


Fig. P2.77

**2.78** Analyze Prob. 2.77 for arbitrary depth  $h$  and gate radius  $R$  and derive a formula for the opening force  $P$ . Is there anything unusual about your solution?

**Solution:** Referring to Fig. P2.77, the force  $F$  and its line of action are given by

$$F = \gamma h_{CG} A = \gamma h (\pi R^2)$$

$$y_{CP} = -\frac{I_{xx} \sin \theta}{h_{CG} A} = -\frac{(\pi/4)R^4 \sin 90^\circ}{h(\pi R^2)} = -\frac{R^2}{4h}$$

Summing moments about the hinge line B then gives

$$\sum M_B = 0 = (\gamma h \pi R^2) \left( \frac{R^2}{4h} \right) - P(R), \quad \text{or: } P = \frac{\pi}{4} \gamma R^3 \quad \text{Ans.}$$

What is unusual, at least to non-geniuses, is that the result is independent of depth  $h$ .

**2.79** Gate ABC in Fig. P2.79 is 1-m-square and hinged at B. It opens automatically when the water level is high enough. Neglecting atmospheric pressure, determine the lowest level  $h$  for which the gate will open. Is your result independent of the liquid density?

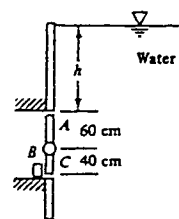


Fig. P2.79

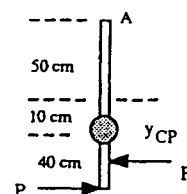
**Solution:** The gate will open when the hydrostatic force  $F$  on the gate is *above* B, that is, when

$$|y_{CP}| = \frac{I_{xx} \sin \theta}{h_{CG} A}$$

$$= \frac{(1/12)(1 \text{ m})(1 \text{ m})^3 \sin 90^\circ}{(h + 0.5 \text{ m})(1 \text{ m}^2)} < 0.1 \text{ m},$$

$$\text{or: } h + 0.5 > 0.833 \text{ m}, \quad \text{or: } \mathbf{h > 0.333 \text{ m}} \quad \text{Ans.}$$

Indeed, this result is independent of the liquid density.



**2.80** For the closed tank of Fig. P2.80, all fluids are at 20°C and the air space is pressurized. If the outward net hydrostatic force on the 40-cm by 30-cm panel at the bottom is 8450 N, estimate (a) the pressure in the air space; and (b) the reading  $h$  on the manometer.

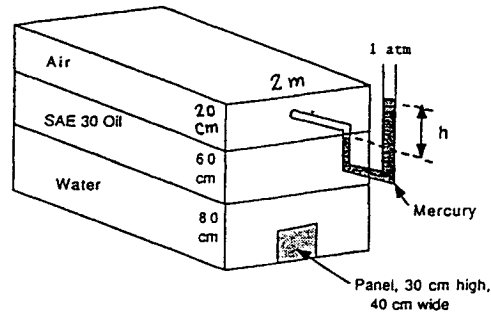


Fig. P2.80

**Solution:** The force on the panel yields water (gage) pressure at the centroid of the panel:

$$F = 8450 \text{ N} = p_{CG} A = p_{CG} (0.3 \times 0.4 \text{ m}^2), \quad \text{or} \quad p_{CG} = 70417 \text{ Pa (gage)}$$

This is the water pressure 15 cm above the bottom. Now work your way back through the two liquids to the air space:

$$p_{\text{air space}} = 70417 \text{ Pa} - (9790)(0.80 - 0.15) - 8720(0.60) = \mathbf{58800 \text{ Pa}} \quad \text{Ans. (a)}$$

Neglecting the specific weight of air, we move out through the mercury to the atmosphere:

$$58800 \text{ Pa} - (133100 \text{ N/m}^3)h = p_{\text{atm}} = 0 \text{ (gage)}, \quad \text{or:} \quad h = \mathbf{0.44 \text{ m}} \quad \text{Ans. (b)}$$

**2.81** Gate AB is 7 ft into the paper and weighs 3000 lbf when submerged. It is hinged at B and rests against a smooth wall at A. Find the water level  $h$  which will just cause the gate to open.

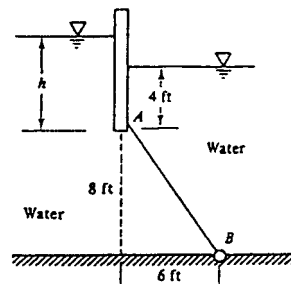
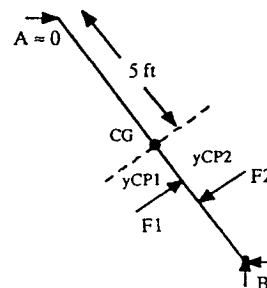


Fig. P2.81

**Solution:** On the right side,  $h_{CG} = 8$  ft, and

$$\begin{aligned} F_2 &= \gamma h_{CG2} A_2 \\ &= (62.4)(8)(70) = 34944 \text{ lbf} \\ y_{CP2} &= -\frac{(1/12)(7)(10)^3 \sin(53.13^\circ)}{(8)(70)} \\ &= -0.833 \text{ ft} \end{aligned}$$



On the right side, we have to write everything in terms of the centroidal depth  $h_{CG1} = h + 4$  ft:

$$F_1 = (62.4)(h_{CG1})(70) = 4368h_{CG1}$$

$$y_{CP1} = -\frac{(1/2)(7)(10)^3 \sin(53.13^\circ)}{h_{CG1}(70)} = -\frac{6.67}{h_{CG1}}$$

Then we sum moments about B in the freebody above, taking  $F_A = 0$  (gate opening):

$$\sum M_B = 0 = 4368h_{CG1} \left( 5 - \frac{6.67}{h_{CG1}} \right) - 34944(5 - 0.833) - 3000(5 \cos 53.13^\circ),$$

$$\text{or: } h_{CG1} = \frac{183720}{21840} = 8.412 \text{ ft, or: } h = h_{CG1} - 4 = \mathbf{4.41 \text{ ft}} \quad \text{Ans.}$$

**2.82** The dam in Fig. P2.82 is a quarter-circle 50 m wide into the paper. Determine the horizontal and vertical components of hydrostatic force against the dam and the point CP where the resultant strikes the dam.

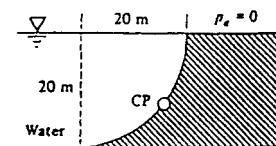


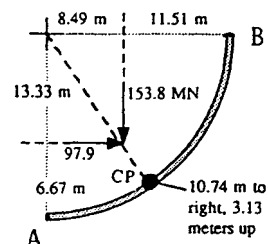
Fig. P2.82

**Solution:** The horizontal force acts as if the dam were vertical and 20 m high:

$$F_H = \gamma h_{CG} A_{\text{vert}}$$

$$= (9790 \text{ N/m}^3)(10 \text{ m})(20 \times 50 \text{ m}^2)$$

$$= \mathbf{97.9 \text{ MN}} \quad \text{Ans.}$$



This force acts 2/3 of the way down or 13.33 m from the surface, as in the figure at right. The vertical force is the weight of the fluid above the dam:

$$F_V = \gamma(\text{Vol})_{\text{dam}} = (9790 \text{ N/m}^3) \frac{\pi}{4} (20 \text{ m})^2 (50 \text{ m}) = \mathbf{153.8 \text{ MN}} \quad \text{Ans.}$$

This vertical component acts through the centroid of the water above the dam, or  $4R/3\pi = 4(20 \text{ m})/3\pi = 8.49 \text{ m}$  to the right of point A, as shown in the figure. The resultant hydrostatic force is  $F = [(97.9 \text{ MN})^2 + (153.8 \text{ MN})^2]^{1/2} = \mathbf{182.3 \text{ MN}}$  acting down at an angle of  $\mathbf{32.5^\circ}$  from the vertical. The line of action of F strikes the circular-arc dam AB at the center of pressure CP, which is  $\mathbf{10.74 \text{ m to the right and } 3.13 \text{ m up from point A}}$ , as shown in the figure. *Ans.*

**2.83** Gate AB is a quarter-circle 10 ft wide and hinged at B. Find the force  $F$  just sufficient to keep the gate from opening. The gate is uniform and weighs 3000 lbf.

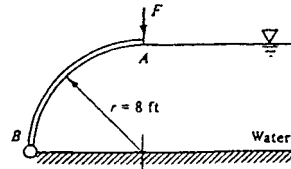


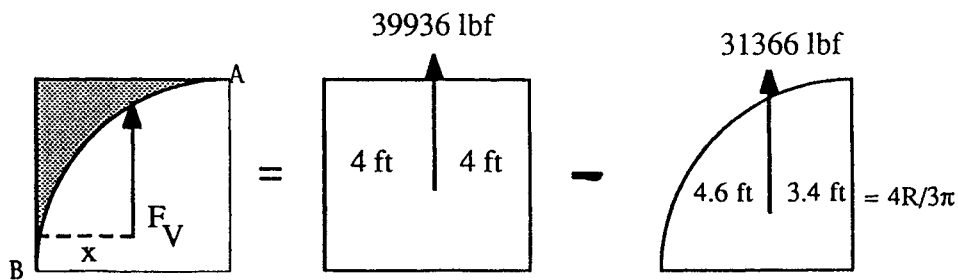
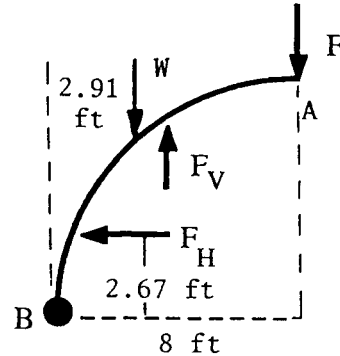
Fig. P2.83

**Solution:** The horizontal force is computed as if AB were vertical:

$$F_H = \gamma h_{CG} A_{\text{vert}} = (62.4)(4 \text{ ft})(8 \times 10 \text{ ft}^2) \\ = 19968 \text{ lbf} \quad \text{acting } 5.33 \text{ ft below } A$$

The vertical force equals the weight of the missing piece of water above the gate, as shown below.

$$F_V = (62.4)(8)(8 \times 10) - (62.4)(\pi/4)(8)^2(10) \\ = 39936 - 31366 = 8570 \text{ lbf}$$



The line of action  $x$  for this 8570-lbf force is found by summing moments from above:

$$\sum M_B(\text{of } F_V) = 8570x = 39936(4.0) - 31366(4.605), \quad \text{or } x = 1.787 \text{ ft}$$

Finally, there is the 3000-lbf gate weight  $W$ , whose centroid is  $2R/\pi = 5.093$  ft from force  $F$ , or  $8.0 - 5.093 = 2.907$  ft from point B. Then we may sum moments about hinge B to find the force  $F$ , using the freebody of the gate as sketched at the top-right of this page:

$$\sum M_B(\text{clockwise}) = 0 = F(8.0) + (3000)(2.907) - (8570)(1.787) - (19968)(2.667), \\ \text{or } F = \frac{59840}{8.0} = \mathbf{7480 \text{ lbf}} \quad \text{Ans.}$$

**2.84** Determine (a) the total hydrostatic force on curved surface AB in Fig. P2.84 and (b) its line of action. Neglect atmospheric pressure and assume unit width into the paper.

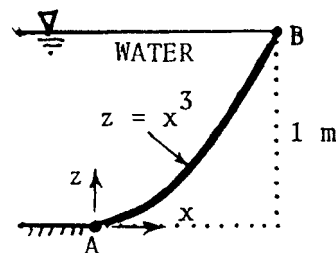


Fig. P2.84

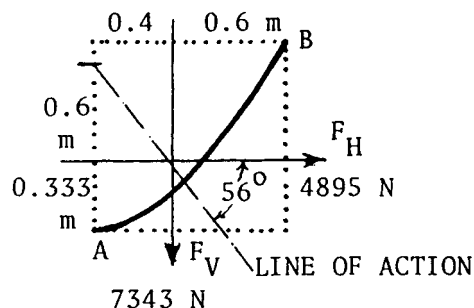
**Solution:** The horizontal force is

$$F_H = \gamma h_{CG} A_{vert} = (9790 \text{ N/m}^3)(0.5 \text{ m})(1 \times 1 \text{ m}^2) = 4895 \text{ N at } 0.667 \text{ m below B.}$$

For the cubic-shaped surface AB, the weight of water above is computed by integration:

$$F_V = \gamma b \int_0^1 (1 - x^3) dx = \frac{3}{4} \gamma b$$

$$= (3/4)(9790)(1.0) = 7343 \text{ N}$$



The line of action (water centroid) of the vertical force also has to be found by integration:

$$\bar{x} = \frac{\int x dA}{\int dA} = \frac{\int_0^1 x(1 - x^3) dx}{\int_0^1 (1 - x^3) dx} = \frac{3/10}{3/4} = 0.4 \text{ m}$$

The vertical force of 7343 N thus acts at 0.4 m to the right of point A, or 0.6 m to the left of B, as shown in the sketch above. The resultant hydrostatic force then is

$$F_{total} = [(4895)^2 + (7343)^2]^{1/2} = 8825 \text{ N acting at } 56.31^\circ \text{ down and to the right. Ans.}$$

This result is shown in the sketch at above right. The line of action of F strikes the vertical above point A at 0.933 m above A, or 0.067 m below the water surface.

**2.85** Compute the horizontal and vertical components of the hydrostatic force on the quarter-circle panel at the bottom of the water tank in Fig. P2.85.

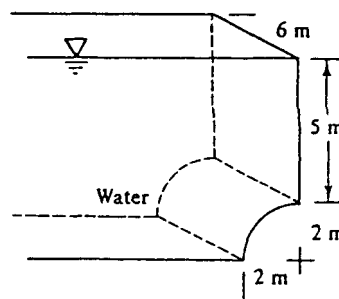


Fig. P2.85

**Solution:** The horizontal component is

$$F_H = \gamma h_{CG} A_{vert} = (9790)(6)(2 \times 6)$$

$$= 705000 \text{ N Ans. (a)}$$

The vertical component is the weight of the fluid above the quarter-circle panel:

$$\begin{aligned} F_V &= W(2 \text{ by } 7 \text{ rectangle}) - W(\text{quarter-circle}) \\ &= (9790)(2 \times 7 \times 6) - (9790)(\pi/4)(2)^2(6) \\ &= 822360 - 184537 = \mathbf{638000 \text{ N}} \quad \text{Ans. (b)} \end{aligned}$$

**2.86** The quarter circle gate BC in Fig. P2.86 is hinged at C. Find the horizontal force  $P$  required to hold the gate stationary. The width  $b$  into the paper is 3 m.

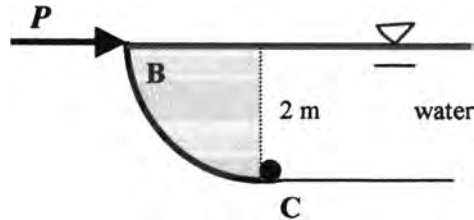


Fig. P2.86

**Solution:** The horizontal component of water force is

$$F_H = \gamma h_{CG} A = (9790 \text{ N/m}^3)(1 \text{ m})[(2 \text{ m})(3 \text{ m})] = 58,740 \text{ N}$$

This force acts  $2/3$  of the way down or 1.333 m down from the surface (0.667 m up from C). The vertical force is the weight of the quarter-circle of water above gate BC:

$$F_V = \gamma(\text{Vol})_{\text{water}} = (9790 \text{ N/m}^3)[(\pi/4)(2 \text{ m})^2(3 \text{ m})] = 92,270 \text{ N}$$

$F_V$  acts down at  $(4R/3\pi) = 0.849 \text{ m}$  to the left of C. Sum moments clockwise about point C:

$$\sum M_C = 0 = (2 \text{ m})P - (58740 \text{ N})(0.667 \text{ m}) - (92270 \text{ N})(0.849 \text{ m}) = 2P - 117480$$

$$\text{Solve for } P = 58,700 \text{ N} = \mathbf{58.7 \text{ kN}} \quad \text{Ans.}$$

**2.87** The bottle of champagne (SG = 0.96) in Fig. P2.87 is under pressure as shown by the mercury manometer reading. Compute the net force on the 2-in-radius hemispherical end cap at the bottom of the bottle.

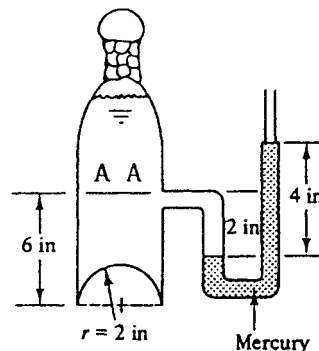


Fig. P2.87

**Solution:** First, from the manometer, compute the gage pressure at section AA in the



champagne 6 inches above the bottom:

$$p_{AA} + (0.96 \times 62.4) \left( \frac{2}{12} \text{ ft} \right) - (13.56 \times 62.4) \left( \frac{4}{12} \text{ ft} \right) = p_{\text{atmosphere}} = 0 \text{ (gage)},$$

$$\text{or: } P_{AA} = 272 \text{ lbf/ft}^2 \text{ (gage)}$$

Then the force on the bottom end cap is vertical only (due to symmetry) and equals the force at section AA plus the weight of the champagne below AA:

$$\begin{aligned} F &= F_V = p_{AA}(\text{Area})_{AA} + W_{6\text{-in cylinder}} - W_{2\text{-in hemisphere}} \\ &= (272) \frac{\pi}{4} (4/12)^2 + (0.96 \times 62.4) \pi (2/12)^2 (6/12) - (0.96 \times 62.4) (2\pi/3) (2/12)^3 \\ &= 23.74 + 2.61 - 0.58 \approx \mathbf{25.8 \text{ lbf}} \quad \text{Ans.} \end{aligned}$$

**2.88** Circular-arc *Tainter* gate ABC pivots about point O. For the position shown, determine (a) the hydrostatic force on the gate (per meter of width into the paper); and (b) its line of action. Does the force pass through point O?

**Solution:** The horizontal hydrostatic force is based on vertical projection:

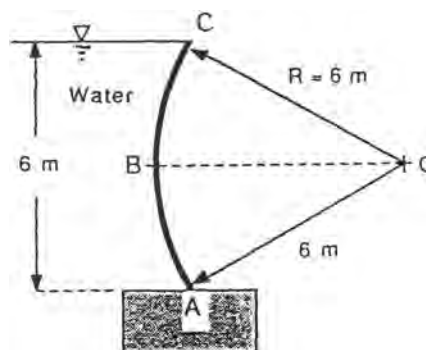
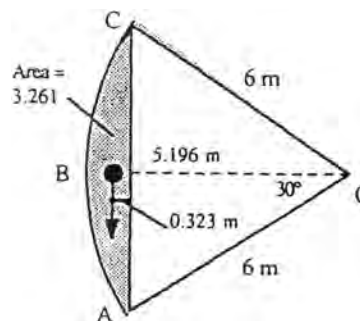


Fig. P2.88

$$F_H = \gamma h_{CG} A_{\text{vert}} = (9790)(3)(6 \times 1) = 176220 \text{ N} \quad \text{at 4 m below C}$$

The vertical force is *upward* and equal to the weight of the missing water in the segment ABC shown shaded below. Reference to a good handbook will give you the geometric properties of a circular segment, and you may compute that the segment area is  $3.261 \text{ m}^2$  and its centroid is  $5.5196 \text{ m}$  from point O, or  $0.3235 \text{ m}$  from vertical line AC, as shown in the figure. The vertical (upward) hydrostatic force on gate ABC is thus



$$\begin{aligned} F_V &= \gamma A_{ABC}(\text{unit width}) = (9790)(3.2611) \\ &= 31926 \text{ N} \quad \text{at 0.4804 m from B} \end{aligned}$$

The net force is thus  $F = [F_H^2 + F_V^2]^{1/2} = \mathbf{179100\text{ N}}$  per meter of width, acting upward to the right at an angle of  $\mathbf{10.27^\circ}$  and passing through a point 1.0 m below and 0.4804 m to the right of point B. This force passes, as expected, *right through point O*.

**2.89** The tank in the figure contains benzene and is pressurized to 200 kPa (gage) in the air gap. Determine the vertical hydrostatic force on circular-arc section AB and its line of action.

**Solution:** Assume unit depth into the paper. The vertical force is the weight of benzene plus the force due to the air pressure:

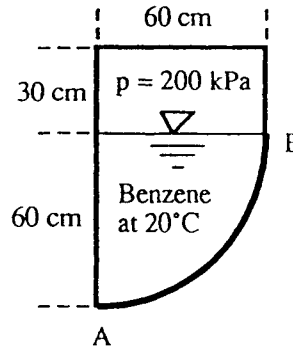


Fig. P2.89

$$F_V = \frac{\pi}{4}(0.6)^2(1.0)(881)(9.81) + (200,000)(0.6)(1.0) = \mathbf{122400 \frac{N}{m}} \quad \text{Ans.}$$

Most of this (120,000 N/m) is due to the air pressure, whose line of action is in the middle of the horizontal line through B. The vertical benzene force is 2400 N/m and has a line of action (see Fig. 2.13 of the text) at  $4R/(3\pi) = 25.5\text{ cm}$  to the right of A.

The moment of these two forces about A must equal to moment of the combined (122,400 N/m) force times a distance X to the right of A:

$$(120000)(30\text{ cm}) + (2400)(25.5\text{ cm}) = 122400(X), \quad \text{solve for } \mathbf{X = 29.9\text{ cm}} \quad \text{Ans.}$$

The vertical force is  $\mathbf{122400\text{ N/m}}$  (down), acting at  $\mathbf{29.9\text{ cm}}$  to the right of A.

**2.90** A 1-ft-diameter hole in the bottom of the tank in Fig. P2.90 is closed by a  $45^\circ$  conical plug. Neglecting plug weight, compute the force F required to keep the plug in the hole.

**Solution:** The part of the cone that is inside the water is 0.5 ft in radius and  $h = 0.5/\tan(22.5^\circ) = 1.207\text{ ft}$  high. The force F equals the air gage pressure times the hole

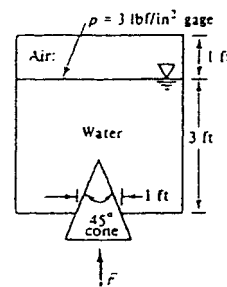


Fig. P2.90

area plus the weight of the water above the plug:

$$\begin{aligned}
 F &= p_{\text{gage}} A_{\text{hole}} + W_{3\text{-ft-cylinder}} - W_{1.207\text{-ft-cone}} \\
 &= (3 \times 144) \frac{\pi}{4} (1 \text{ ft})^2 + (62.4) \frac{\pi}{4} (1)^2 (3) - (62.4) \left[ \left( \frac{1}{3} \right) \frac{\pi}{4} (1)^2 (1.207) \right] \\
 &= 339.3 + 147.0 - 19.7 = \mathbf{467 \text{ lbf}} \quad \text{Ans.}
 \end{aligned}$$

**2.91** The hemispherical dome in Fig. P2.91 weighs 30 kN and is filled with water and attached to the floor by six equally-spaced bolts. What is the force in each bolt required to hold the dome down?

**Solution:** Assuming no leakage, the hydrostatic force required equals the *weight of missing water*, that is, the water in a 4-m-diameter cylinder, 6 m high, minus the hemisphere and the small pipe:

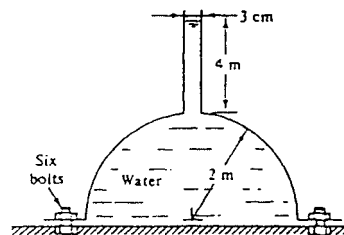


Fig. P2.91

$$\begin{aligned}
 F_{\text{total}} &= W_{2\text{-m-cylinder}} - W_{2\text{-m-hemisphere}} - W_{3\text{-cm-pipe}} \\
 &= (9790)\pi(2)^2(6) - (9790)(2\pi/3)(2)^3 - (9790)(\pi/4)(0.03)^2(4) \\
 &= 738149 - 164033 - 28 = 574088 \text{ N}
 \end{aligned}$$

The dome material helps with 30 kN of weight, thus the bolts must supply 574088–30000 or 544088 N. The force in each of 6 bolts is 544088/6 or  $F_{\text{bolt}} \approx \mathbf{90700 \text{ N}}$  Ans.

**2.92** A 4-m-diameter water tank consists of two half-cylinders, each weighing 4.5 kN/m, bolted together as in Fig. P2.92. If the end caps are neglected, compute the force in each bolt.

**Solution:** Consider a 25-cm width of upper cylinder, as at right. The water pressure in the bolt plane is

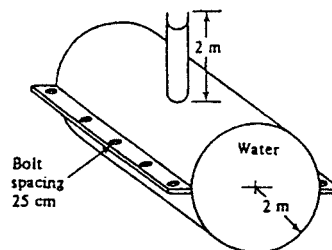
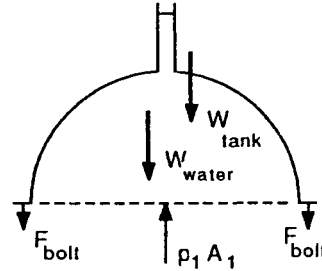


Fig. P2.92

$$p_1 = \gamma h = (9790)(4) = 39160 \text{ Pa}$$

Then summation of vertical forces on this 25-cm-wide freebody gives

$$\begin{aligned}\Sigma F_z = 0 &= p_1 A_1 - W_{\text{water}} - W_{\text{tank}} - 2F_{\text{bolt}} \\ &= (39160)(4 \times 0.25) - (9790)(\pi/2)(2)^2(0.25) \\ &\quad - (4500)/4 - 2F_{\text{bolt}},\end{aligned}$$



Solve for  $F_{\text{one bolt}} = 11300 \text{ N}$  Ans.

**2.93** In Fig. P2.93 a one-quadrant spherical shell of radius  $R$  is submerged in liquid of specific weight  $\gamma$  and depth  $h > R$ . Derive an analytic expression for the hydrodynamic force  $F$  on the shell and its line of action.

**Solution:** The two horizontal components are identical in magnitude and equal to the force on the quarter-circle side panels, whose centroids are  $(4R/3\pi)$  above the bottom:

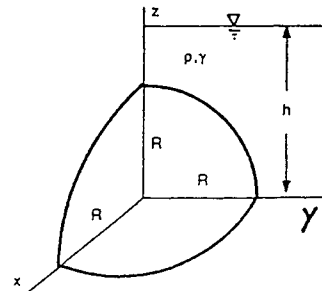


Fig. P2.93

$$\text{Horizontal components: } F_x = F_y = \gamma h_{\text{CG}} A_{\text{vert}} = \gamma \left( h - \frac{4R}{3\pi} \right) \frac{\pi}{4} R^2$$

Similarly, the vertical component is the weight of the fluid above the spherical surface:

$$F_z = W_{\text{cylinder}} - W_{\text{sphere}} = \gamma \left( \frac{\pi}{4} R^2 h \right) - \gamma \left( \frac{1}{8} \frac{4}{3} \pi R^3 \right) = \gamma \frac{\pi}{4} R^2 \left( h - \frac{2R}{3} \right)$$

There is no need to find the (complicated) centers of pressure for these three components, for we know that the resultant on a spherical surface *must pass through the center*. Thus

$$F = \left[ F_x^2 + F_y^2 + F_z^2 \right]^{1/2} = \gamma \frac{\pi}{4} R^2 \left[ (h - 2R/3)^2 + 2(h - 4R/3\pi)^2 \right]^{1/2} \text{ Ans.}$$

**2.94** The 4-ft-diameter log (SG = 0.80) in Fig. P2.94 is 8 ft long into the paper and dams water as shown. Compute the net vertical and horizontal reactions at point C.

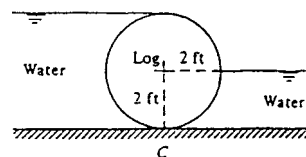


Fig. P2.94

**Solution:** With respect to the sketch at right, the horizontal components of hydrostatic force are given by

$$F_{h1} = (62.4)(2)(4 \times 8) = 3994 \text{ lbf}$$

$$F_{h2} = (62.4)(1)(2 \times 8) = 998 \text{ lbf}$$

The vertical components of hydrostatic force equal the weight of water in the shaded areas:

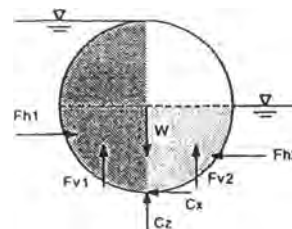
$$F_{v1} = (62.4) \frac{\pi}{2} (2)^2 (8) = 3137 \text{ lbf}$$

$$F_{v2} = (62.4) \frac{\pi}{4} (2)^2 (8) = 1568 \text{ lbf}$$

The weight of the log is  $W_{\text{log}} = (0.8 \times 62.4)\pi(2)^2(8) = 5018 \text{ lbf}$ . Then the reactions at C are found by summation of forces on the log freebody:

$$\sum F_x = 0 = 3994 - 998 - C_x, \text{ or } C_x = \mathbf{2996 \text{ lbf}} \text{ Ans.}$$

$$\sum F_z = 0 = C_z - 5018 + 3137 + 1568, \text{ or } C_z = \mathbf{313 \text{ lbf}} \text{ Ans.}$$

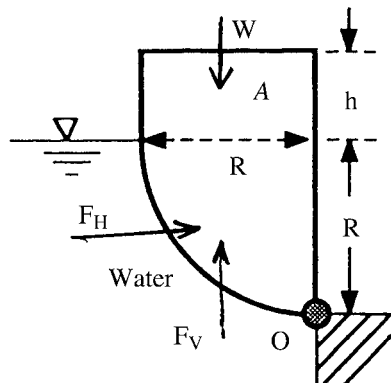


**2.95** The uniform body A in the figure has width  $b$  into the paper and is in static equilibrium when pivoted about hinge O. What is the specific gravity of this body when (a)  $h = 0$ ; and (b)  $h = R$ ?

**Solution:** The water causes a horizontal and a vertical force on the body, as shown:

$$F_H = \gamma \frac{R}{2} Rb \text{ at } \frac{R}{3} \text{ above O,}$$

$$F_V = \gamma \frac{\pi}{4} R^2 b \text{ at } \frac{4R}{3\pi} \text{ to the left of O}$$



These must balance the moment of the body weight  $W$  about O:

$$\sum M_O = \frac{\gamma R^2 b}{2} \left( \frac{R}{3} \right) + \frac{\gamma \pi R^2 b}{4} \left( \frac{4R}{3\pi} \right) - \gamma_s \pi R^2 b \left( \frac{4R}{3\pi} \right) - \gamma_s R h b \left( \frac{R}{2} \right) = 0$$

$$\text{Solve for: } SG_{body} = \frac{\gamma_s}{\gamma} = \left[ \frac{2}{3} + \frac{h}{R} \right]^{-1} \quad \text{Ans.}$$

For  $h = 0$ ,  $SG = 3/2$  Ans. (a). For  $h = R$ ,  $SG = 3/5$  Ans. (b).

**2.96** Curved panel BC is a  $60^\circ$  arc, perpendicular to the bottom at C. If the panel is 4 m wide into the paper, estimate the resultant hydrostatic force of the water on the panel.

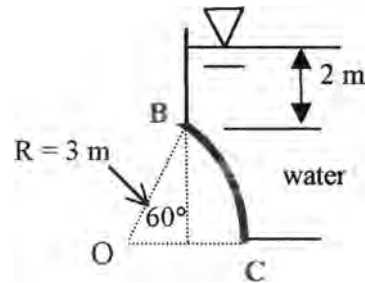
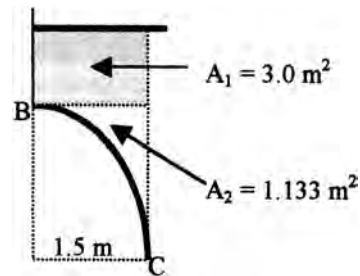


Fig. P2.96

**Solution:** The horizontal force is,

$$\begin{aligned} F_H &= \gamma h_{CG} A_h \\ &= (9790 \text{ N/m}^3) [2 + 0.5(3 \sin 60^\circ) \text{ m}] \\ &\quad \times [(3 \sin 60^\circ) \text{ m} (4 \text{ m})] \\ &= 335,650 \text{ N} \end{aligned}$$

The vertical component equals the weight of water above the gate, which is the sum of the rectangular piece above BC, and the curvy triangular piece of water just above arc BC—see figure at right. (The curvy-triangle calculation is messy and is not shown here.)



$$F_V = \gamma (\text{Vol})_{\text{above BC}} = (9790 \text{ N/m}^3) [(3.0 + 1.133 \text{ m}^2) (4 \text{ m})] = 161,860 \text{ N}$$

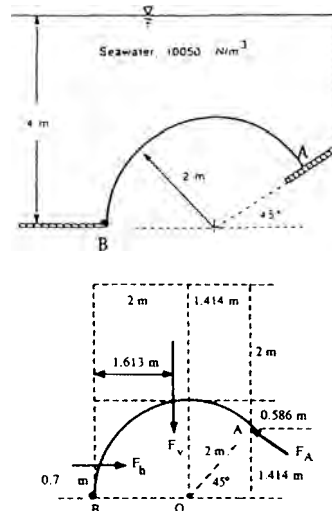
The resultant force is thus,

$$F_R = [(335,650)^2 + (161,860)^2]^{1/2} = 372,635 \text{ N} = \mathbf{373 \text{ kN}} \quad \text{Ans.}$$

This resultant force acts along a line which passes through point O at

$$\theta = \tan^{-1}(161,860/335,650) = \mathbf{25.7^\circ}$$

**2.97** Gate AB is a 3/8th circle, 3 m wide into the paper, hinged at B and resting on a smooth wall at A. Compute the reaction forces at A and B.



**Solution:** The two hydrostatic forces are

$$\begin{aligned} F_h &= \gamma h_{CG} A_h \\ &= (10050)(4 - 0.707)(1.414 \times 3) \\ &= 140 \text{ kN} \end{aligned}$$

$$F_v = \text{weight above AB} = 240 \text{ kN}$$

To find the reactions, we need the lines of action of these two forces—a laborious task which is summarized in the figure at right. Then summation of moments on the gate, about B, gives

$$\sum M_{B, \text{clockwise}} = 0 = (140)(0.70) + (240)(1.613) - F_A(3.414), \text{ or } F_A = \mathbf{142 \text{ kN}} \text{ Ans.}$$

Finally, summation of vertical and horizontal forces gives

$$\sum F_z = B_z + 142 \sin 45^\circ - 240 = 0, \text{ or } B_z = \mathbf{139 \text{ kN}}$$

$$\sum F_x = B_x - 142 \cos 45^\circ = 0, \text{ or } B_x = \mathbf{99 \text{ kN}} \text{ Ans.}$$

**2.98** Gate ABC in Fig. P2.98 is a quarter circle 8 ft wide into the paper. Compute the horizontal and vertical hydrostatic forces on the gate and the line of action of the resultant force.

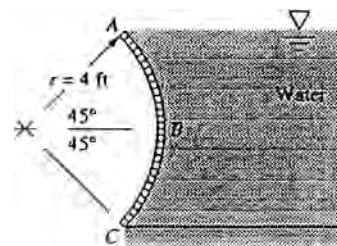


Fig. P2.98

**Solution:** The horizontal force is

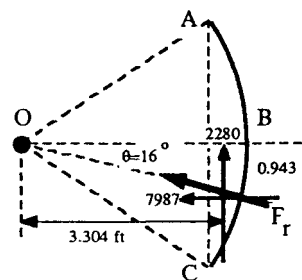
$$\begin{aligned} F_h &= \gamma h_{CG} A_h = (62.4)(2.828)(5.657 \times 8) \\ &= \mathbf{7987 \text{ lbf}} \leftarrow \end{aligned}$$

located at

$$y_{cp} = -\frac{(1/2)(8)(5.657)^3}{(2.828)(5.657 \times 8)} = -0.943 \text{ ft}$$

$$\begin{aligned} \text{Area ABC} &= (\pi/4)(4)^2 - (4 \sin 45^\circ)^2 \\ &= 4.566 \text{ ft}^2 \end{aligned}$$

$$\text{Thus } F_v = \gamma \text{Vol}_{ABC} = (62.4)(8)(4.566) = \mathbf{2280 \text{ lbf}} \uparrow$$



The resultant is found to be

$$F_R = [(7987)^2 + (2280)^2]^{1/2} = \mathbf{8300 \text{ lbf}}$$
 acting at  $\theta = 15.9^\circ$  through the center O. *Ans.*

**2.99** A 2-ft-diam sphere weighing 400 kbf closes the 1-ft-diam hole in the tank bottom. Find the force  $F$  to dislodge the sphere from the hole.

**Solution:** NOTE: This problem is laborious! Break up the system into regions I, II, III, IV, & V. The respective volumes are:

$$v_{\text{III}} = 0.0539 \text{ ft}^3; \quad v_{\text{II}} = 0.9419 \text{ ft}^3$$

$$v_{\text{IV}} = v_{\text{I}} = v_{\text{V}} = 1.3603 \text{ ft}^3$$

Then the hydrostatic forces are:

$$F_{\text{down}} = \gamma v_{\text{II}} = (62.4)(0.9419) = 58.8 \text{ lbf}$$

$$F_{\text{up}} = \gamma(v_{\text{I}} + v_{\text{V}}) = (62.4)(2.7206) \\ = 169.8 \text{ lbf}$$

Then the required force is  $F = W + F_{\text{down}} - F_{\text{up}} = 400 + 59 - 170 = \mathbf{289 \text{ lbf}} \uparrow$  *Ans.*

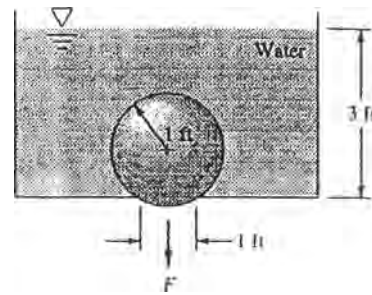
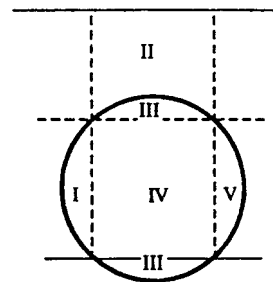


Fig. P2.99



**2.100** Pressurized water fills the tank in Fig. P2.100. Compute the hydrostatic force on the conical surface ABC.

**Solution:** The gage pressure is equivalent to a fictitious water level  $h = p/\gamma = 150000/9790 = 15.32 \text{ m}$  above the gage or 8.32 m above AC. Then the vertical force on the cone equals the weight of fictitious water above ABC:

$$F_V = \gamma \text{Vol}_{\text{above}} \\ = (9790) \left[ \frac{\pi}{4} (2)^2 (8.32) + \frac{1}{3} \frac{\pi}{4} (2)^2 (4) \right] \\ = \mathbf{297,000 \text{ N}} \quad \text{Ans.}$$

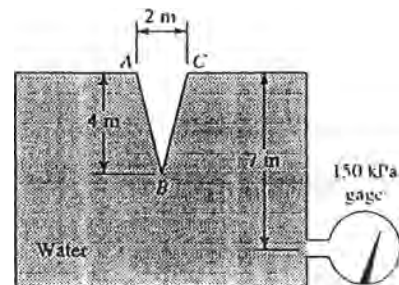
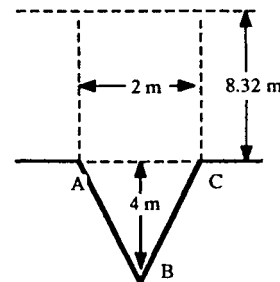
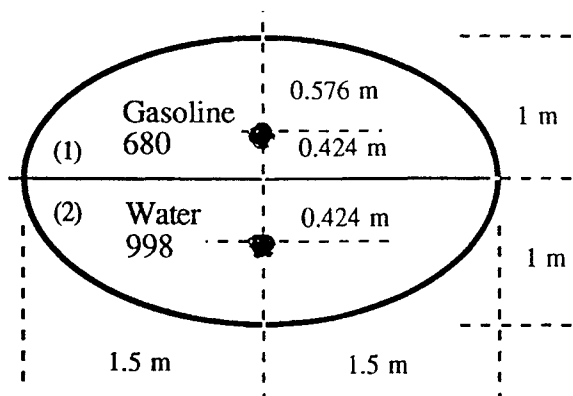


Fig. P2.100





**2.101** A fuel tank has an elliptical cross-section as shown, with gasoline in the (vented) top and water in the bottom half. Estimate the total hydrostatic force on the flat end panel of the tank. The major axis is 3 m wide. The minor axis is 2 m high.



**Solution:** The centroids of the top and bottom halves are  $4(1 \text{ m})/(3\pi) = 0.424 \text{ m}$  from the center, as shown. The area of each half ellipse is  $(\pi/2)(1 \text{ m})(1.5 \text{ m}) = 2.356 \text{ m}^2$ . The forces on panel #1 in the gasoline and on panel #2 in the water are:

$$F_1 = \rho_1 g h_{CG1} A_1 = (680)(9.81)(0.576)(2.356) = 9050 \text{ N}$$

$$F_2 = \rho_{CG2} A_2 = [680(1.0) + 998(0.424)](9.81)(2.356) = 25500 \text{ N}$$

Then the total hydrostatic force on the end plate is  $9050 + 25500 \approx \mathbf{34600 \text{ N}}$  *Ans.*

**2.102** A cubical tank is  $3 \times 3 \times 3 \text{ m}$  and is layered with 1 meter of fluid of specific gravity 1.0, 1 meter of fluid with  $SG = 0.9$ , and 1 meter of fluid with  $SG = 0.8$ . Neglect atmospheric pressure. Find (a) the hydrostatic force on the bottom; and (b) the force on a side panel.

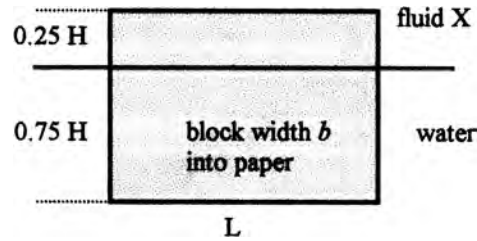
**Solution:** (a) The force on the bottom is the bottom pressure times the bottom area:

$$\begin{aligned} F_{\text{bot}} &= p_{\text{bot}} A_{\text{bot}} = (9790 \text{ N/m}^3)[(0.8 \times 1 \text{ m}) + (0.9 \times 1 \text{ m}) + (1.0 \times 1 \text{ m})](3 \text{ m})^2 \\ &= \mathbf{238,000 \text{ N}} \quad \text{Ans. (a)} \end{aligned}$$

(b) The hydrostatic force on the side panel is the sum of the forces due to each layer:

$$\begin{aligned} F_{\text{side}} &= \sum \gamma h_{CG} A_{\text{side}} = (0.8 \times 9790 \text{ N/m}^3)(0.5 \text{ m})(3 \text{ m}^2) + (0.9 \times 9790 \text{ N/m}^3)(1.5 \text{ m})(3 \text{ m}^2) \\ &\quad + (9790 \text{ N/m}^3)(2.5 \text{ m})(3 \text{ m}^2) = \mathbf{125,000 \text{ kN}} \quad \text{Ans. (b)} \end{aligned}$$

**2.103** A solid block, of specific gravity 0.9, floats such that 75% of its volume is in water and 25% of its volume is in fluid X, which is layered above the water. What is the specific gravity of fluid X?



**Solution:** The block is sketched at right. A force balance is

$$0.9\gamma(HbL) = \gamma(0.75HbL) + SG_X\gamma(0.25HbL)$$

$$0.9 - 0.75 = 0.25SG_X, \quad SG_X = \mathbf{0.6} \quad \text{Ans.}$$

**2.104** The can in Fig. P2.104 floats in the position shown. What is its weight in newtons?

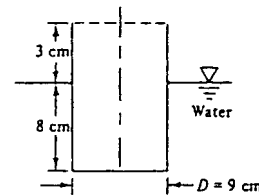


Fig. P2.104

**Solution:** The can weight simply equals the weight of the displaced water:

$$W = \gamma v_{\text{displaced}} = (9790) \frac{\pi}{4} (0.09 \text{ m})^2 (0.08 \text{ m}) = \mathbf{5.0 \text{ N}} \quad \text{Ans.}$$

**2.105** Archimedes, when asked by King Hiero if the new crown was pure gold ( $SG = 19.3$ ), found the crown weight in air to be 11.8 N and in water to be 10.9 N. Was it gold?

**Solution:** The buoyancy is the difference between air weight and underwater weight:

$$B = W_{\text{air}} - W_{\text{water}} = 11.8 - 10.9 = 0.9 \text{ N} = \gamma_{\text{water}} v_{\text{crown}}$$

$$\text{But also } W_{\text{air}} = (SG)\gamma_{\text{water}} v_{\text{crown}}, \quad \text{so } W_{\text{in water}} = B(SG - 1)$$

$$\text{Solve for } SG_{\text{crown}} = 1 + W_{\text{in water}}/B = 1 + 10.9/0.9 = \mathbf{13.1 \text{ (not pure gold)}} \quad \text{Ans.}$$

**2.106** A spherical helium balloon is 2.5 m in diameter and has a total mass of 6.7 kg. When released into the U. S. Standard Atmosphere, at what altitude will it settle?

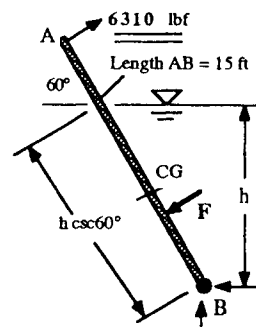
**Solution:** The altitude can be determined by calculating the air density to provide the proper buoyancy and then using Table A.3 to find the altitude associated with this density:

$$\rho_{\text{air}} = m_{\text{balloon}} / \text{Vol}_{\text{sphere}} = (6.7 \text{ kg}) / [\pi(2.5 \text{ m}^3) / 6] = 0.819 \text{ kg/m}^3$$

From Table A.3, atmospheric air has  $\rho = 0.819 \text{ kg/m}^3$  at an altitude of about **4000 m**. *Ans.*

**2.107** Repeat Prob. 2.62 assuming that the 10,000 lbf weight is aluminum (SG = 2.71) and is hanging submerged in the water.

**Solution:** Refer back to Prob. 2.62 for details. The only difference is that the force applied to gate AB by the weight is less due to buoyancy:



$$F_{\text{net}} = \frac{(SG-1)}{SG} \gamma_{\text{body}} = \frac{2.71-1}{2.71} (10000) = 6310 \text{ lbf}$$

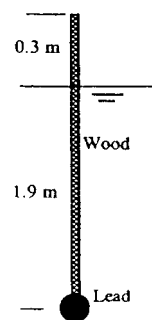
This force replaces “10000” in the gate moment relation (see Prob. 2.62):

$$\sum M_B = 0 = 6310(15) - (288.2h^2) \left( \frac{h}{2} \csc 60^\circ - \frac{h}{6} \csc 60^\circ \right) - 4898(7.5 \cos 60^\circ)$$

$$\text{or: } h^3 = 76280 / 110.9 = 688, \quad \text{or: } h = \mathbf{8.83 \text{ ft}} \quad \text{Ans.}$$

**2.108** A yellow pine rod (SG = 0.65) is 5 cm by 5 cm by 2.2 m long. How much lead (SG = 11.4) is needed at one end so that the rod will float vertically with 30 cm out of the water?

**Solution:** The weight of wood and lead must equal the buoyancy of immersed wood and lead:



$$W_{\text{wood}} + W_{\text{lead}} = B_{\text{wood}} + B_{\text{lead}},$$

$$\text{or: } (0.65)(9790)(0.05)^2(2.2) + 11.4(9790)v_{\text{lead}} = (9790)(0.05)^2(1.9) + 9790v_{\text{lead}}$$

$$\text{Solve for } v_{\text{lead}} = 0.000113 \text{ m}^3 \quad \text{whence } W_{\text{lead}} = 11.4(9790)v_{\text{lead}} = \mathbf{12.6 \text{ N}} \quad \text{Ans.}$$

**2.109** The float level  $h$  of a hydrometer is a measure of the specific gravity of the liquid. For stem diameter  $D$  and total weight  $W$ , if  $h = 0$  represents  $SG = 1.0$ , derive a formula for  $h$  as a function of  $W$ ,  $D$ ,  $SG$ , and  $\gamma_o$  for water.

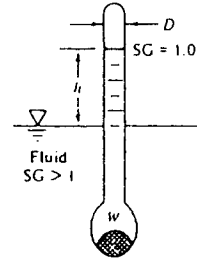
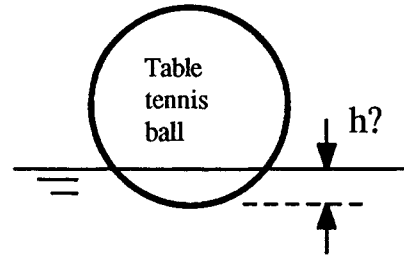


Fig. P2.109

**Solution:** Let submerged volume be  $v_o$  when  $SG = 1$ . Let  $A = \pi D^2/4$  be the area of the stem. Then

$$W = \gamma_o v_o = (SG)\gamma_o(v_o - Ah), \quad \text{or:} \quad \mathbf{h = \frac{W(SG - 1)}{SG\gamma_o(\pi D^2/4)} \quad \text{Ans.}}$$

**2.110** An average table tennis ball has a diameter of 3.81 cm and a mass of 2.6 gm. Estimate the (small) depth  $h$  at which the ball will float in water at 20°C and sea-level standard air if air buoyancy is (a) neglected; or (b) included.



**Solution:** For both parts we need the volume of the submerged spherical segment:

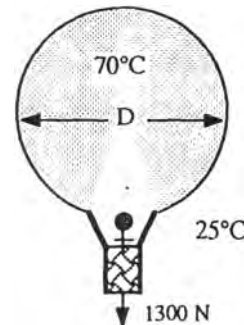
$$W = 0.0026(9.81) = 0.0255 \text{ N} = \rho_{\text{water}} g \frac{\pi h^2}{3} (3R - h), \quad R = 0.01905 \text{ m}, \quad \rho = 998 \frac{\text{kg}}{\text{m}^3}$$

- (a) Air buoyancy is neglected. Solve for  $h \approx 0.00705 \text{ m} = \mathbf{7.05 \text{ mm}}$  Ans. (a)  
 (b) Also include air buoyancy on the exposed sphere volume in the air:

$$0.0255 \text{ N} = \rho_w g v_{\text{seg}} + \rho_{\text{air}} g \left[ \frac{4}{3} \pi R^3 - v_{\text{seg}} \right], \quad \rho_{\text{air}} = 1.225 \frac{\text{kg}}{\text{m}^3}$$

The air buoyancy is only one-80<sup>th</sup> of the water. Solve  $\mathbf{h = 7.00 \text{ mm}}$  Ans. (b)

**2.111** A hot-air balloon must support its own weight plus a person for a total weight of 1300 N. The balloon material has a mass of 60 g/m<sup>2</sup>. Ambient air is at 25°C and 1 atm. The hot air inside the balloon is at 70°C and 1 atm. What diameter spherical balloon will just support the weight? Neglect the size of the hot-air inlet vent.



**Solution:** The buoyancy is due to the difference between hot and cold air density:

$$\rho_{\text{cold}} = \frac{p}{RT_{\text{cold}}} = \frac{101350}{(287)(273+25)} = 1.185 \frac{\text{kg}}{\text{m}^3}; \quad \rho_{\text{hot}} = \frac{101350}{287(273+70)} = 1.030 \frac{\text{kg}}{\text{m}^3}$$

The buoyant force must balance the known payload of 1300 N:

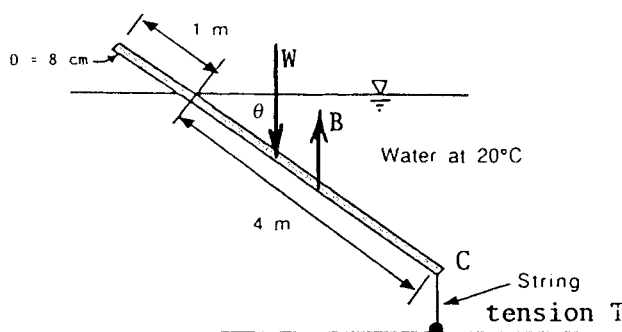
$$W = 1300 \text{ N} = \Delta\rho g \text{ Vol} = (1.185 - 1.030)(9.81) \frac{\pi}{6} D^3,$$

$$\text{Solve for } D^3 = 1628 \text{ or } D_{\text{balloon}} \approx \mathbf{11.8 \text{ m}} \text{ Ans.}$$

Check to make sure the balloon material is not excessively heavy:

$$W(\text{balloon}) = (0.06 \text{ kg/m}^2)(9.81 \text{ m/s}^2)(\pi)(11.8 \text{ m})^2 \approx 256 \text{ N} \text{ OK, only 20\% of } W_{\text{total}}.$$

**2.112** The uniform 5-m-long wooden rod in the figure is tied to the bottom by a string. Determine (a) the string tension; and (b) the specific gravity of the wood. Is it also possible to determine the inclination angle  $\theta$ ?



**Fig. P2.112**

**Solution:** The rod weight acts at the middle, 2.5 m from point  $C$ , while the buoyancy is 2 m from  $C$ . Summing moments about  $C$  gives

$$\sum M_C = 0 = W(2.5 \sin \theta) - B(2.0 \sin \theta), \text{ or } W = 0.8B$$

$$\text{But } B = (9790)(\pi/4)(0.08 \text{ m})^2(4 \text{ m}) = 196.8 \text{ N.}$$

$$\text{Thus } W = 0.8B = 157.5 \text{ N} = \text{SG}(9790)(\pi/4)(0.08)^2(5 \text{ m}), \text{ or: } \text{SG} \approx \mathbf{0.64} \text{ Ans. (b)}$$

Summation of vertical forces yields

$$\text{String tension } T = B - W = 196.8 - 157.5 \approx \mathbf{39 \text{ N}} \text{ Ans. (a)}$$

These results are independent of the angle  $\theta$ , which cancels out of the moment balance.

**2.113** A *spar buoy* is a rod weighted to float vertically, as in Fig. P2.113. Let the buoy be maple wood (SG = 0.6), 2 in by 2 in by 10 ft, floating in seawater (SG = 1.025). How many pounds of steel (SG = 7.85) should be added at the bottom so that  $h = 18$  in?

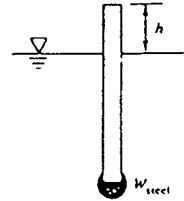


Fig. P2.113

**Solution:** The relevant volumes needed are

$$\text{Spar volume} = \frac{2}{12} \left( \frac{2}{12} \right) (10) = 0.278 \text{ ft}^3; \quad \text{Steel volume} = \frac{W_{\text{steel}}}{7.85(62.4)}$$

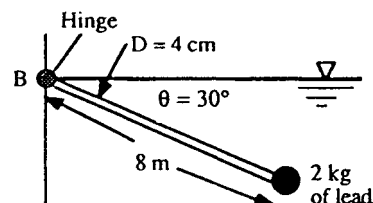
$$\text{Immersed spar volume} = \frac{2}{12} \left( \frac{2}{12} \right) (8.5) = 0.236 \text{ ft}^3$$

The vertical force balance is: buoyancy  $B = W_{\text{wood}} + W_{\text{steel}}$ ,

$$\text{or: } 1.025(62.4) \left[ 0.236 + \frac{W_{\text{steel}}}{7.85(62.4)} \right] = 0.6(62.4)(0.278) + W_{\text{steel}}$$

$$\text{or: } 15.09 + 0.1306W_{\text{steel}} = 10.40 + W_{\text{steel}}, \quad \text{solve for } W_{\text{steel}} \approx \mathbf{5.4 \text{ lbf}} \quad \text{Ans.}$$

**2.114** The uniform rod in the figure is hinged at B and in static equilibrium when 2 kg of lead (SG = 11.4) are attached at its end. What is the specific gravity of the rod material? What is peculiar about the rest angle  $\theta = 30^\circ$ ?



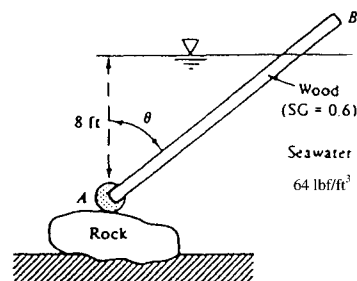
**Solution:** First compute buoyancies:  $B_{\text{rod}} = 9790(\pi/4)(0.04)^2(8) = 98.42 \text{ N}$ , and  $W_{\text{lead}} = 2(9.81) = 19.62 \text{ N}$ ,  $B_{\text{lead}} = 19.62/11.4 = 1.72 \text{ N}$ . Sum moments about B:

$$\sum M_B = 0 = (SG - 1)(98.42)(4 \cos 30^\circ) + (19.62 - 1.72)(8 \cos 30^\circ) = 0$$

$$\text{Solve for } \mathbf{SG_{\text{rod}} = 0.636} \quad \text{Ans. (a)}$$

The angle  $\theta$  drops out! The rod is neutrally stable for **any tilt angle!** Ans. (b)

**2.115** The 2 inch by 2 inch by 12 ft spar buoy from Fig. P2.113 has 5 lbm of steel attached and has gone aground on a rock. If the rock exerts no moments on the spar, compute the angle of inclination  $\theta$ .



**Solution:** Let  $\zeta$  be the submerged length of spar. The relevant forces are:

$$W_{\text{wood}} = (0.6)(64.0) \left( \frac{2}{12} \right) \left( \frac{2}{12} \right) (12) = 12.8 \text{ lbf} \quad \text{at distance } 6 \sin \theta \text{ to the right of } A \downarrow$$

$$\text{Buoyancy} = (64.0) \left( \frac{2}{12} \right) \left( \frac{2}{12} \right) \zeta = 1.778 \zeta \quad \text{at distance } \frac{\zeta}{2} \sin \theta \text{ to the right of } A \uparrow$$

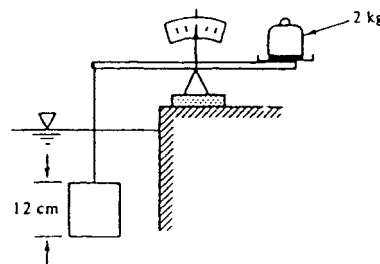
The steel force acts right through A. Take moments about A:

$$\sum M_A = 0 = 12.8(6 \sin \theta) - 1.778 \zeta \left( \frac{\zeta}{2} \sin \theta \right)$$

$$\text{Solve for } \zeta^2 = 86.4, \text{ or } \zeta = 9.295 \text{ ft (submerged length)}$$

Thus the angle of inclination  $\theta = \cos^{-1}(8.0/9.295) = \mathbf{30.6^\circ}$  Ans.

**2.116** When the 12-cm cube in the figure is immersed in 20°C ethanol, it is balanced on the beam scale by a 2-kg mass. What is the specific gravity of the cube?



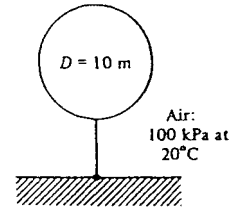
**Fig. P2.116**

**Solution:** The scale force is  $2(9.81) = 19.62$  N. The specific weight of ethanol is  $7733 \text{ N/m}^3$ . Then

$$F = 19.62 = (W - B)_{\text{cube}} = (\gamma_{\text{cube}} - 7733)(0.12 \text{ m})^3$$

$$\text{Solve for } \gamma_{\text{cube}} = 7733 + 19.62/(0.12)^3 \approx \mathbf{19100 \text{ N/m}^3} \text{ Ans.}$$

**2.117** The balloon in the figure is filled with helium and pressurized to 135 kPa and 20°C. The balloon material has a mass of 85 g/m<sup>2</sup>. Estimate (a) the tension in the mooring line, and (b) the height in the standard atmosphere to which the balloon will rise if the mooring line is cut.



**Fig. P2.117**

**Solution:** (a) For helium, from Table A-4,  $R = 2077 \text{ m}^2/\text{s}^2/\text{K}$ , hence its weight is

$$W_{\text{helium}} = \rho_{\text{He}} g v_{\text{balloon}} = \left[ \frac{135000}{2077(293)} \right] (9.81) \left[ \frac{\pi}{6} (10)^3 \right] = 1139 \text{ N}$$

Meanwhile, the total weight of the balloon material is

$$W_{\text{balloon}} = \left( 0.085 \frac{\text{kg}}{\text{m}^2} \right) \left( 9.81 \frac{\text{m}}{\text{s}^2} \right) [\pi (10 \text{ m})^2] = 262 \text{ N}$$

Finally, the balloon buoyancy is the weight of displaced air:

$$B_{\text{air}} = \rho_{\text{air}} g v_{\text{balloon}} = \left[ \frac{100000}{287(293)} \right] (9.81) \left[ \frac{\pi}{6} (10)^3 \right] = 6108 \text{ N}$$

The difference between these is the tension in the mooring line:

$$T_{\text{line}} = B_{\text{air}} - W_{\text{helium}} - W_{\text{balloon}} = 6108 - 1139 - 262 \approx \mathbf{4700 \text{ N}} \quad \text{Ans. (a)}$$

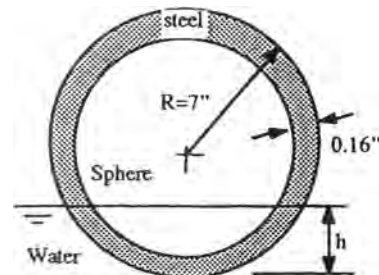
(b) If released, and the balloon remains at 135 kPa and 20°C, equilibrium occurs when the balloon air buoyancy exactly equals the total weight of  $1139 + 262 = 1401 \text{ N}$ :

$$B_{\text{air}} = 1401 \text{ N} = \rho_{\text{air}} (9.81) \frac{\pi}{6} (10)^3, \quad \text{or} \quad \rho_{\text{air}} \approx 0.273 \frac{\text{kg}}{\text{m}^3}$$

From Table A-6, this standard density occurs at approximately

$$\mathbf{Z \approx 12,800 \text{ m}} \quad \text{Ans. (b)}$$

**2.118** A 14-in-diameter hollow sphere of steel (SG = 7.85) has 0.16 in wall thickness. How high will this sphere float in 20°C water? How much weight must be added inside to make the sphere neutrally buoyant?





**Solution:** The weight of the steel is

$$W_{\text{steel}} = \gamma V_{\text{ol}} = (7.85)(62.4) \frac{\pi}{6} \left[ \left( \frac{14}{12} \right)^3 - \left( \frac{13.68}{12} \right)^3 \right]$$

$$= 27.3 \text{ lbf}$$

This is equivalent to  $27.3/62.4 = 0.437 \text{ ft}^3$  of displaced water, whereas  $v_{\text{sphere}} = 0.831 \text{ ft}^3$ .

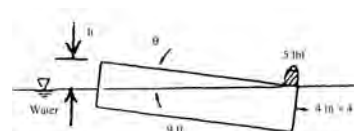
Therefore the sphere floats *slightly above* its midline, such that the sphere segment volume, of height  $h$  in the figure, equals the displaced volume:

$$v_{\text{segment}} = 0.437 \text{ ft}^3 = \frac{\pi}{3} h^2 (3R - h) = \frac{\pi}{3} h^2 [3(7/12) - h]$$

Solve for  $h = 0.604 \text{ ft} \approx \mathbf{7.24 \text{ in}}$  Ans.

In order for the sphere to be *neutrally* buoyant, we need another  $(0.831 - 0.437) = 0.394 \text{ ft}^3$  of displaced water, so we need additional weight  $\Delta W = 62.4(0.394) \approx \mathbf{25 \text{ lbf}}$ . Ans.

**2.119** With a 5-lbf-weight placed at one end, the uniform wooden beam in the figure floats at an angle  $\theta$  with its upper right corner at the surface. Determine (a)  $\theta$ , (b)  $\gamma_{\text{wood}}$ .



**Fig. P2.119**

**Solution:** The total wood volume is  $(4/12)^2(9) = 1 \text{ ft}^3$ . The exposed distance  $h = 9 \tan \theta$ . The vertical forces are

$$\sum F_z = 0 = (62.4)(1.0) - (62.4)(h/2)(9)(4/12) - (SG)(62.4)(1.0) - 5 \text{ lbf}$$

The moments of these forces about point C at the right corner are:

$$\sum M_C = 0 = \gamma(1)(4.5) - \gamma(1.5h)(6 \text{ ft}) - (SG)(\gamma)(1)(4.5 \text{ ft}) + (5 \text{ lbf})(0 \text{ ft})$$

where  $\gamma = 62.4 \text{ lbf/ft}^3$  is the specific weight of water. Clean these two equations up:

$$1.5h = 1 - SG - 5/\gamma \quad (\text{forces}) \quad 2.0h = 1 - SG \quad (\text{moments})$$

Solve simultaneously for  $SG \approx \mathbf{0.68}$  Ans. (b);  $h = 0.16 \text{ ft}$ ;  $\theta \approx \mathbf{1.02^\circ}$  Ans. (a)

**2.120** A uniform wooden beam ( $SG = 0.65$ ) is 10 cm by 10 cm by 3 m and hinged at A. At what angle will the beam float in 20°C water?

**Solution:** The total beam volume is  $3(0.1)^2 = 0.03 \text{ m}^3$ , and therefore its weight is  $W = (0.65)(9790)(0.03) = 190.9 \text{ N}$ , acting at the centroid, 1.5 m down from point A. Meanwhile, if the submerged length is  $H$ , the buoyancy is  $B = (9790)(0.1)^2 H = 97.9H$  newtons, acting at  $H/2$  from the lower end. Sum moments about point A:

$$\sum M_A = 0 = (97.9H)(3.0 - H/2) \cos \theta - 190.9(1.5 \cos \theta),$$

$$\text{or: } H(3 - H/2) = 2.925, \quad \text{solve for } H \approx 1.225 \text{ m}$$

Geometry:  $3 - H = 1.775 \text{ m}$  is out of the water, or:  $\sin \theta = 1.0/1.775$ , or  $\theta \approx 34.3^\circ$  Ans.

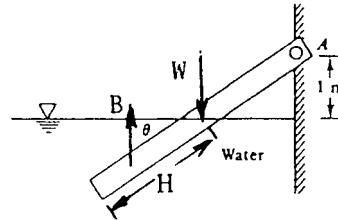


Fig. P2.120

**2.121** The uniform beam in the figure is of size  $L$  by  $h$  by  $b$ , with  $b, h \ll L$ . A uniform heavy sphere tied to the left corner causes the beam to float exactly on its diagonal. Show that this condition requires (a)  $\gamma_b = \gamma/3$ ; and (b)  $D = [Lhb / \{\pi(SG - 1)\}]^{1/3}$ .

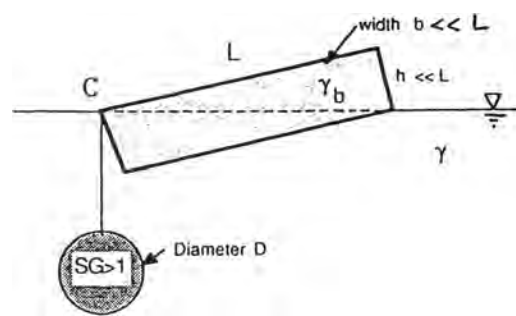


Fig. P2.121

**Solution:** The beam weight  $W = \gamma_b Lhb$  and acts in the center, at  $L/2$  from the left corner, while the buoyancy, being a perfect triangle of displaced water, equals  $B = \gamma Lhb/2$  and acts at  $L/3$  from the left corner. Sum moments about the left corner, point C:

$$\sum M_C = 0 = (\gamma_b Lhb)(L/2) - (\gamma Lhb/2)(L/3), \quad \text{or: } \gamma_b = \gamma/3 \quad \text{Ans. (a)}$$

Then summing vertical forces gives the required string tension  $T$  on the left corner:

$$\sum F_z = 0 = \gamma Lhb/2 - \gamma_b Lhb - T, \quad \text{or } T = \gamma Lhb/6 \quad \text{since } \gamma_b = \gamma/3$$

$$\text{But also } T = (W - B)_{\text{sphere}} = (SG - 1)\gamma \frac{\pi}{6} D^3, \quad \text{so that } D = \left[ \frac{Lhb}{\pi(SG - 1)} \right]^{1/3} \quad \text{Ans. (b)}$$

**2.122** A uniform block of steel (SG = 7.85) will “float” at a mercury-water interface as in the figure. What is the ratio of the distances  $a$  and  $b$  for this condition?

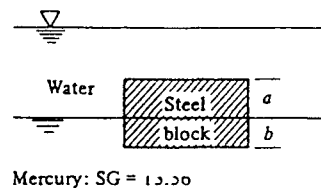


Fig. P2.122

**Solution:** Let  $w$  be the block width into the paper and let  $\gamma$  be the water specific weight. Then the vertical force balance on the block is

$$7.85\gamma(a+b)Lw = 1.0\gamma aLw + 13.56\gamma bLw,$$

$$\text{or } 7.85a + 7.85b = a + 13.56b, \quad \text{solve for } \frac{a}{b} = \frac{13.56 - 7.85}{7.85 - 1} = \mathbf{0.834} \quad \text{Ans.}$$

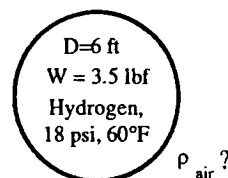
**2.123** A spherical balloon is filled with helium at sea level. Helium and balloon material together weigh 500 N. If the net upward lift force on the balloon is also 500 N, what is the diameter of the balloon?

**Solution:** Since the net upward force is 500 N, the buoyancy force is 500 N plus the weight of the balloon and helium, or  $B = 1000$  N. From Table A.3, the density of air at sea level is  $1.2255 \text{ kg/m}^3$ .

$$B = 1000 \text{ N} = \rho_{\text{air}} g V_{\text{balloon}} = (1.2255)(9.81)(\pi/6)D^3$$

$$\mathbf{D = 5.42 \text{ m} \quad \text{Ans.}}$$

**2.124** A balloon weighing 3.5 lbf is 6 ft in diameter. If filled with hydrogen at 18 psia and  $60^\circ\text{F}$  and released, at what U.S. standard altitude will it be neutral?



**Solution:** Assume that it remains at 18 psia and  $60^\circ\text{F}$ . For hydrogen, from Table A-4,  $R \approx 24650 \text{ ft}^2/(\text{s}^2 \cdot ^\circ\text{R})$ . The density of the hydrogen in the balloon is thus

$$\rho_{\text{H}_2} = \frac{p}{RT} = \frac{18(144)}{(24650)(460 + 60)} \approx 0.000202 \text{ slug/ft}^3$$

In the vertical force balance for neutral buoyancy, only the outside air density is unknown:

$$\sum F_z = B_{\text{air}} - W_{\text{H}_2} - W_{\text{balloon}} = \rho_{\text{air}} (32.2) \frac{\pi}{6} (6)^3 - (0.000202)(32.2) \frac{\pi}{6} (6)^3 - 3.5 \text{ lbf}$$

$$\text{Solve for } \rho_{\text{air}} \approx 0.00116 \text{ slug/ft}^3 \approx 0.599 \text{ kg/m}^3$$

From Table A-6, this density occurs at a standard altitude of **6850 m**  $\approx$  **22500 ft**. *Ans.*

**2.125** Suppose the balloon in Prob. 2.111 is constructed with a diameter of 14 m, is filled at sea level with hot air at 70°C and 1 atm, and released. If the hot air remains at 70°C, at what U.S. standard altitude will the balloon become neutrally buoyant?

**Solution:** Recall from Prob. 2.111 that the hot air density is  $p/RT_{\text{hot}} \approx 1.030 \text{ kg/m}^3$ . Assume that the entire weight of the balloon consists of its material, which from Prob. 2.111 had a density of 60 grams per square meter of surface area. Neglect the vent hole. Then the vertical force balance for neutral buoyancy yields the air density:

$$\begin{aligned} \sum F_z &= B_{\text{air}} - W_{\text{hot}} - W_{\text{balloon}} \\ &= \rho_{\text{air}}(9.81)\frac{\pi}{6}(14)^3 - (1.030)(9.81)\frac{\pi}{6}(14)^3 - (0.06)(9.81)\pi(14)^2 \end{aligned}$$

$$\text{Solve for } \rho_{\text{air}} \approx 1.0557 \text{ kg/m}^3.$$

From Table A-6, this air density occurs at a standard altitude of **1500 m**. *Ans.*

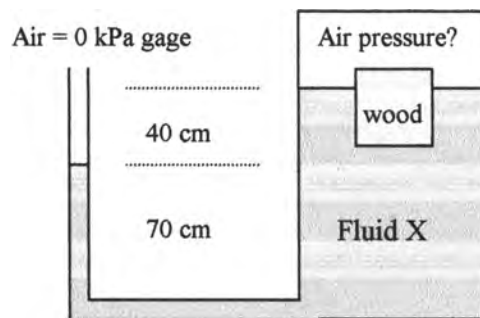
**2.126** A block of wood (SG = 0.6) floats in fluid X in Fig. P2.126 such that 75% of its volume is submerged in fluid X. Estimate the gage pressure of the air in the tank.

**Solution:** In order to apply the hydrostatic relation for the air pressure calculation, the density of Fluid X must be found. The buoyancy principle is thus first applied. Let the block have volume  $V$ . Neglect the buoyancy of the air on the upper part of the block. Then

$$0.6\gamma_{\text{water}}V = \gamma_X(0.75V) + \gamma_{\text{air}}(0.25V); \quad \gamma_X \approx 0.8\gamma_{\text{water}} = 7832 \text{ N/m}^3$$

The air gage pressure may then be calculated by jumping from the left interface into fluid X:

$$0 \text{ Pa-gage} - (7832 \text{ N/m}^3)(0.4 \text{ m}) = p_{\text{air}} = -3130 \text{ Pa-gage} = \mathbf{3130 \text{ Pa-vacuum}} \quad \textit{Ans.}$$



**Fig. P2.126**

**2.127\*** Consider a cylinder of specific gravity  $S < 1$  floating vertically in water ( $S = 1$ ), as in Fig. P2.127. Derive a formula for the stable values of  $D/L$  as a function of  $S$  and apply it to the case  $D/L = 1.2$ .

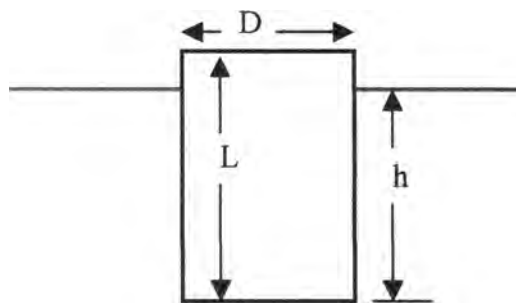


Fig. P2.127

**Solution:** A vertical force balance provides a relation for  $h$  as a function of  $S$  and  $L$ ,

$$\gamma \pi D^2 h / 4 = S \gamma \pi D^2 L / 4, \quad \text{thus } h = SL$$

To compute stability, we turn Eq. (2.52), centroid  $G$ , metacenter  $M$ , center of buoyancy  $B$ :

$$MB = I_o / v_{\text{sub}} = \frac{\frac{\pi}{4} (D/2)^4}{\frac{\pi}{4} Dh} = MG + GB \quad \text{and substituting } h = SL, \quad \frac{D^2}{16SL} = MG + GB$$

where  $GB = L/2 - h/2 = L/2 - SL/2 = L(1 - S)/2$ . For neutral stability,  $MG = 0$ . Substituting,

$$\frac{D^2}{16SL} = 0 + \frac{L}{2} (1 - S) \quad \text{solving for } D/L, \quad \frac{D}{L} = \sqrt{8S(1 - S)} \quad \text{Ans.}$$

For  $D/L = 1.2$ ,  $S^2 - S - 0.18 = 0$  giving  $0 \leq S \leq 0.235$  and  $0.765 \leq S \leq 1$  Ans.

**2.128** The iceberg of Fig. 2.20 can be idealized as a cube of side length  $L$  as shown. If seawater is denoted as  $S = 1$ , the iceberg has  $S = 0.88$ . Is it stable?

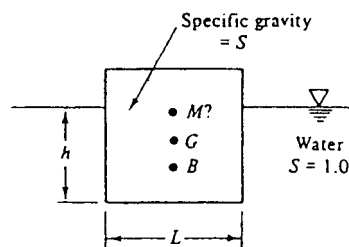


Fig. P2.128

**Solution:** The distance  $h$  is determined by

$$\gamma_w h L^2 = S \gamma_w L^3, \quad \text{or: } h = SL$$

The center of gravity is at  $L/2$  above the bottom, and  $B$  is at  $h/2$  above the bottom. The metacenter position is determined by Eq. (2.52):

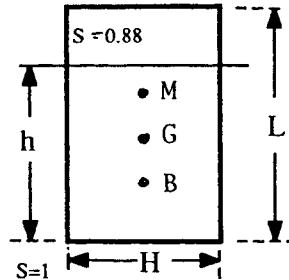
$$MB = I_o / v_{\text{sub}} = \frac{L^4 / 12}{L^2 h} = \frac{L^2}{12h} = \frac{L}{12S} = MG + GB$$

Noting that  $GB = L/2 - h/2 = L(1 - S)/2$ , we may solve for the metacentric height:

$$MG = \frac{L}{12S} - \frac{L}{2}(1-S) = 0 \quad \text{if } S^2 - S + \frac{1}{6} = 0, \text{ or: } S = 0.211 \quad \text{or} \quad 0.789$$

Instability:  $0.211 < S < 0.789$ . Since the iceberg has  $S = 0.88 > 0.789$ , **it is stable.** *Ans.*

**2.129** The iceberg of Prob. 2.128 may become unstable if its width decreases. Suppose that the height is  $L$  and the depth into the paper is  $L$  but the width decreases to  $H < L$ . Again with  $S = 0.88$  for the iceberg, determine the ratio  $H/L$  for which the iceberg becomes unstable.



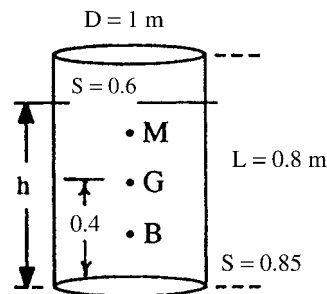
**Solution:** As in Prob. 2.128, the submerged distance  $h = SL = 0.88L$ , with  $G$  at  $L/2$  above the bottom and  $B$  at  $h/2$  above the bottom. From Eq. (2.52), the distance  $MB$  is

$$MB = \frac{I_o}{v_{\text{sub}}} = \frac{LH^3/12}{HL(SL)} = \frac{H^2}{12SL} = MG + GB = MG + \left( \frac{L}{2} - \frac{SL}{2} \right)$$

Then neutral stability occurs when  $MG = 0$ , or

$$\frac{H^2}{12SL} = \frac{L}{2}(1-S), \quad \text{or} \quad \frac{H}{L} = [6S(1-S)]^{1/2} = [6(0.88)(1-0.88)]^{1/2} = \mathbf{0.796} \quad \text{Ans.}$$

**2.130** Consider a wooden cylinder ( $SG = 0.6$ ) 1 m in diameter and 0.8 m long. Would this cylinder be stable if placed to float with its axis vertical in oil ( $SG = 0.85$ )?



**Solution:** A vertical force balance gives

$$0.85\pi R^2 h = 0.6\pi R^2 (0.8 \text{ m}),$$

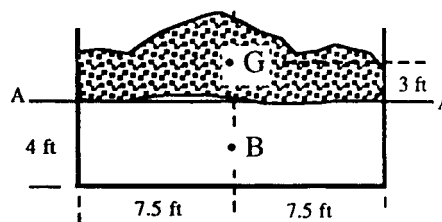
or:  $h = 0.565 \text{ m}$

The point  $B$  is at  $h/2 = 0.282 \text{ m}$  above the bottom. Use Eq. (2.52) to predict the meta-center location:

$$MB = I_o/v_{\text{sub}} = [\pi(0.5)^4/4]/[\pi(0.5)^2(0.565)] = 0.111 \text{ m} = MG + GB$$

Now  $GB = 0.4 \text{ m} - 0.282 \text{ m} = 0.118 \text{ m}$ , hence  $MG = 0.111 - 0.118 = -0.007 \text{ m}$ . This float position is thus **slightly unstable**. The cylinder would turn over. *Ans.*

**2.131** A barge is 15 ft wide and floats with a draft of 4 ft. It is piled so high with gravel that its center of gravity is 3 ft above the waterline, as shown. Is it stable?

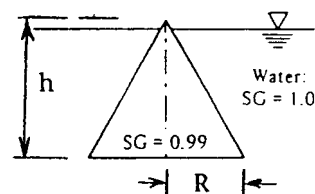


**Solution:** Example 2.10 applies to this case, with  $L = 7.5 \text{ ft}$  and  $H = 4 \text{ ft}$ :

$$MA = \frac{L^2}{3H} - \frac{H}{2} = \frac{(7.5 \text{ ft})^2}{3(4 \text{ ft})} - \frac{4 \text{ ft}}{2} = 2.69 \text{ ft}, \quad \text{where "A" is the waterline}$$

Since  $G$  is 3 ft above the waterline,  $MG = 2.69 - 3.0 = -0.31 \text{ ft}$ , **unstable**. *Ans.*

**2.132** A solid right circular cone has  $SG = 0.99$  and floats vertically as shown. Is this a stable position?



**Fig. P2.132**

**Solution:** Let  $r$  be the radius at the surface and let  $z$  be the exposed height. Then

$$\sum F_z = 0 = \gamma_w \frac{\pi}{3} (R^2 h - r^2 z) - 0.99 \gamma_w \frac{\pi}{3} R^2 h, \quad \text{with } \frac{z}{h} = \frac{r}{R}.$$

$$\text{Thus } \frac{z}{h} = (0.01)^{1/3} = 0.2154$$

The cone floats at a draft  $\zeta = h - z = 0.7846h$ . The centroid  $G$  is at  $0.25h$  above the bottom. The center of buoyancy  $B$  is at the centroid of a frustum of a (submerged) cone:

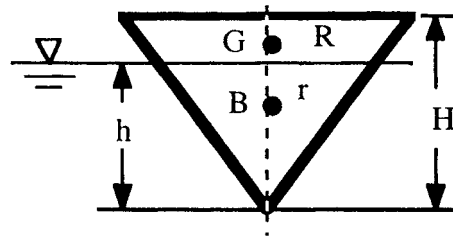
$$\zeta = \frac{0.7846h}{4} \left( \frac{R^2 + 2Rr + 3r^2}{R^2 + Rr + r^2} \right) = 0.2441h \quad \text{above the bottom}$$

Then Eq. (2.52) predicts the position of the metacenter:

$$\begin{aligned} MB &= \frac{I_o}{v_{\text{sub}}} = \frac{\pi(0.2154R)^4/4}{0.99\pi R^2 h} = 0.000544 \frac{R^2}{h} = MG + GB \\ &= MG + (0.25h - 0.2441h) = MG + 0.0594h \end{aligned}$$

Thus  $MG > 0$  (**stability**) if  $(R/h)^2 \geq 10.93$  or  $R/h \geq 3.31$  *Ans.*

**2.133** Consider a uniform right circular cone of specific gravity  $S < 1$ , floating with its vertex down in water,  $S = 1.0$ . The base radius is  $R$  and the cone height is  $H$ , as shown. Calculate and plot the stability parameter  $MG$  of this cone, in dimensionless form, versus  $H/R$  for a range of cone specific gravities  $S < 1$ .



**Solution:** The cone floats at height  $h$  and radius  $r$  such that  $B = W$ , or:

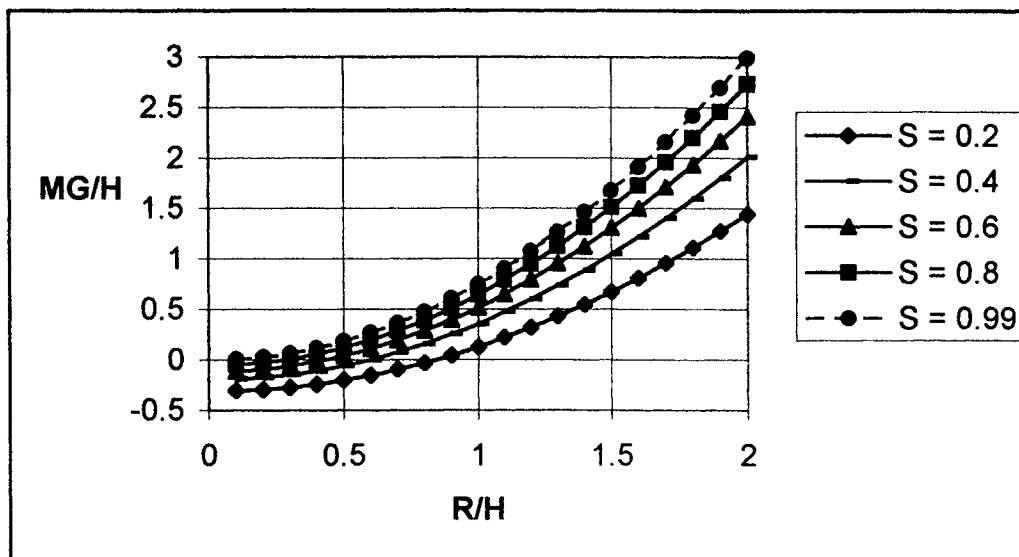
$$\frac{\pi}{3} r^2 h (1.0) = \frac{\pi}{3} R^2 H (S), \quad \text{or:} \quad \frac{h^3}{H^3} = \frac{r^3}{R^3} = S < 1$$

Thus  $r/R = h/H = S^{1/3} = \zeta$  for short. Now use the stability relation:

$$MG + GB = MG + \left( \frac{3H}{4} - \frac{3h}{4} \right) = \frac{I_o}{v_{sub}} = \frac{\pi r^4 / 4}{\pi r^2 h / 3} = \frac{3\zeta R^2}{4H}$$

$$\text{Non-dimensionalize in the final form:} \quad \frac{MG}{H} = \frac{3}{4} \left( \zeta \frac{R^2}{H^2} - 1 + \zeta \right), \quad \zeta = S^{1/3} \quad \text{Ans.}$$

This is plotted below. Floating cones pointing *down* are stable unless slender,  $R \ll H$ .





**2.134** When floating in water ( $SG = 1$ ), an equilateral triangular body ( $SG = 0.9$ ) might take *two* positions, as shown at right. Which position is more stable? Assume large body width into the paper.

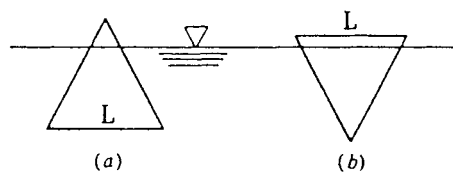


Fig. P2.134

**Solution:** The calculations are similar to the floating cone of Prob. 2.132. Let the triangle be  $L$  by  $L$  by  $L$ . List the basic results.

(a) Floating with point *up*: Centroid  $G$  is  $0.289L$  above the bottom line, center of buoyancy  $B$  is  $0.245L$  above the bottom, hence  $GB = (0.289 - 0.245)L \approx 0.044L$ . Equation (2.52) gives

$$MB = I_o/v_{\text{sub}} = 0.0068L = MG + GB = MG + 0.044L$$

$$\text{Hence } MG = -0.037L \quad \text{Unstable} \quad \text{Ans. (a)}$$

(b) Floating with point *down*: Centroid  $G$  is  $0.577L$  above the bottom point, center of buoyancy  $B$  is  $0.548L$  above the bottom point, hence  $GB = (0.577 - 0.548)L \approx 0.029L$ . Equation (2.52) gives

$$MB = I_o/v_{\text{sub}} = 0.1826L = MG + GB = MG + 0.029L$$

$$\text{Hence } MG = +0.153L \quad \text{Stable} \quad \text{Ans. (b)}$$

**2.135** Consider a homogeneous right circular cylinder of length  $L$ , radius  $R$ , and specific gravity  $SG$ , floating in water ( $SG = 1$ ) with its axis *vertical*. Show that the body is stable if

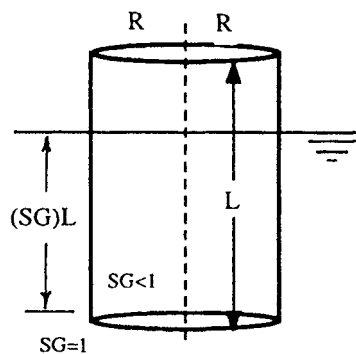
$$R/L > [2SG(1 - SG)]^{1/2}$$

**Solution:** For a given  $SG$ , the body floats with a draft equal to  $(SG)L$ , as shown. Its center of gravity  $G$  is at  $L/2$  above the bottom. Its center of buoyancy  $B$  is at  $(SG)L/2$  above the bottom. Then Eq. (2.52) predicts the metacenter location:

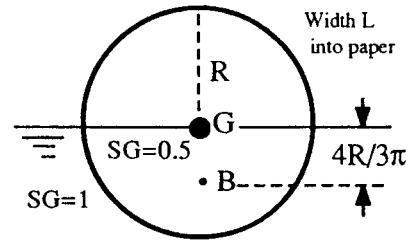
$$MB = I_o/v_{\text{sub}} = \frac{\pi R^4/4}{\pi R^2(SG)L} = \frac{R^2}{4(SG)L} = MG + GB = MG + \frac{L}{2} - SG \frac{L}{2}$$

$$\text{Thus } MG > 0 \text{ (stability) if } R^2/L^2 > 2SG(1 - SG) \quad \text{Ans.}$$

For example, if  $SG = 0.8$ , stability requires that  $R/L > 0.566$ .



**2.136** Consider a homogeneous right circular cylinder of length  $L$ , radius  $R$ , and specific gravity  $SG = 0.5$ , floating in water ( $SG = 1$ ) with its axis *horizontal*. Show that the body is stable if  $L/R > 2.0$ .

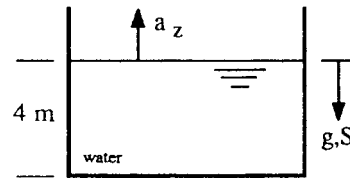


**Solution:** For the given  $SG = 0.5$ , the body floats centrally with a draft equal to  $R$ , as shown. Its center of gravity  $G$  is exactly at the surface. Its center of buoyancy  $B$  is at the centroid of the immersed semicircle:  $4R/(3\pi)$  below the surface. Equation (2.52) predicts the metacenter location:

$$MB = I_o/v_{\text{sub}} = \frac{(1/12)(2R)L^3}{\pi(R^2/2)L} = \frac{L^2}{3\pi R} = MG + GB = MG + \frac{4R}{3\pi}$$

or:  $MG = \frac{L^2}{3\pi R} - \frac{4R}{3\pi} > 0$  (stability) if  $L/R > 2$  Ans.

**2.137** A tank of water 4 m deep receives a constant upward acceleration  $a_z$ . Determine (a) the gage pressure at the tank bottom if  $a_z = 5 \text{ m}^2/\text{s}$ ; and (b) the value of  $a_z$  which causes the gage pressure at the tank bottom to be 1 atm.



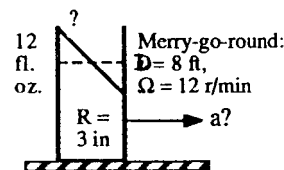
**Solution:** Equation (2.53) states that  $\nabla p = \rho(\mathbf{g} - \mathbf{a}) = \rho(-k\mathbf{g} - k\mathbf{a}_z)$  for this case. Then, for part (a),

$$\Delta p = \rho(g + a_z)\Delta S = (998 \text{ kg/m}^3)(9.81 + 5 \text{ m}^2/\text{s})(4 \text{ m}) = \mathbf{59100 \text{ Pa (gage)}}$$
 Ans. (a)

For part (b), we know  $\Delta p = 1 \text{ atm}$  but we don't know the acceleration:

$$\Delta p = \rho(g + a_z)\Delta S = (998)(9.81 + a_z)(4.0) = 101350 \text{ Pa if } \mathbf{a_z = 15.6 \frac{m}{s^2}}$$
 Ans. (b)

**2.138** A 12 fluid ounce glass, 3 inches in diameter, sits on the edge of a merry-go-round 8 ft in diameter, rotating at 12 r/min. How full can the glass be before it spills?



**Solution:** First, how high is the container? Well, 1 fluid oz. = 1.805 in<sup>3</sup>, hence 12 fl. oz. = 21.66 in<sup>3</sup> =  $\pi(1.5 \text{ in})^2 h$ , or  $h \approx 3.06 \text{ in}$ —It is a fat, nearly square little glass. Second, determine the acceleration toward the center of the merry-go-round, noting that the angular velocity is  $\Omega = (12 \text{ rev/min})(1 \text{ min}/60 \text{ s})(2\pi \text{ rad/rev}) = 1.26 \text{ rad/s}$ . Then, for  $r = 4 \text{ ft}$ ,

$$a_x = \Omega^2 r = (1.26 \text{ rad/s})^2 (4 \text{ ft}) = 6.32 \text{ ft/s}^2$$

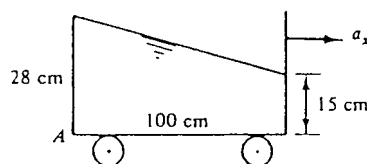
Then, for steady rotation, the water surface in the glass will slope at the angle

$$\tan \theta = \frac{a_x}{g + a_z} = \frac{6.32}{32.2 + 0} = 0.196, \quad \text{or: } \Delta h_{\text{left to center}} = (0.196)(1.5 \text{ in}) = 0.294 \text{ in}$$

Thus the glass should be filled to no more than  $3.06 - 0.294 \approx 2.77$  inches

This amount of liquid is  $v = \pi(1.5 \text{ in})^2(2.77 \text{ in}) = 19.6 \text{ in}^3 \approx \mathbf{10.8 \text{ fluid oz.}}$  *Ans.*

**2.139** The tank of liquid in the figure P2.139 accelerates to the right with the fluid in rigid-body motion. (a) Compute  $a_x$  in  $\text{m/s}^2$ . (b) Why doesn't the solution to part (a) depend upon fluid density? (c) Compute gage pressure at point A if the fluid is glycerin at 20°C.



**Fig. P2.139**

**Solution:** (a) The slope of the liquid gives us the acceleration:

$$\tan \theta = \frac{a_x}{g} = \frac{28 - 15 \text{ cm}}{100 \text{ cm}} = 0.13, \quad \text{or: } \theta = 7.4^\circ$$

$$\text{thus } a_x = 0.13g = 0.13(9.81) = \mathbf{1.28 \text{ m/s}^2} \quad \text{Ans. (a)}$$

(b) Clearly, the solution to (a) is purely geometric and does not involve fluid density. *Ans. (b)*

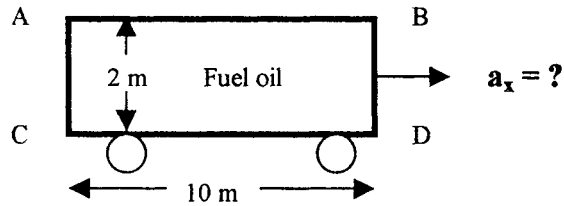
(c) From Table A-3 for glycerin,  $\rho = 1260 \text{ kg/m}^3$ . There are many ways to compute  $p_A$ . For example, we can go straight down on the left side, using only gravity:

$$p_A = \rho g \Delta z = (1260 \text{ kg/m}^3)(9.81 \text{ m/s}^2)(0.28 \text{ m}) = \mathbf{3460 \text{ Pa (gage)}} \quad \text{Ans. (c)}$$

Or we can start on the right side, go down 15 cm with  $g$  and across 100 cm with  $a_x$ :

$$\begin{aligned} p_A &= \rho g \Delta z + \rho a_x \Delta x = (1260)(9.81)(0.15) + (1260)(1.28)(1.00) \\ &= 1854 + 1607 = \mathbf{3460 \text{ Pa}} \quad \text{Ans. (c)} \end{aligned}$$

**2.140** Suppose that the elliptical-end fuel tank in Prob. 2.101 is 10 m long and filled completely with fuel oil ( $\rho = 890 \text{ kg/m}^3$ ). Let the tank be pulled along a horizontal road in rigid-body motion. Find the acceleration and direction for which (a) a constant-pressure surface extends from the top of the front end to the bottom of the back end; and (b) the top of the back end is at a pressure 0.5 atm lower than the top of the front end.



**Solution:** (a) We are given that the isobar or constant-pressure line reaches from point C to point B in the figure above,  $\theta$  is *negative*, hence the tank is *decelerating*. The elliptical shape is immaterial, only the 2-m height. The isobar slope gives the acceleration:

$$\tan \theta_{C-B} = -\frac{2 \text{ m}}{10 \text{ m}} = -0.2 = \frac{a_x}{g}, \quad \text{hence } a_x = -0.2(9.81) = -1.96 \text{ m/s}^2 \quad \text{Ans. (a)}$$

(b) We are now given that  $p_A$  (back end top) is lower than  $p_B$  (front end top)—see the figure above. Thus, again, the isobar must slope upward through B but not necessarily pass through point C. The pressure difference along line AB gives the correct *deceleration*:

$$\Delta p_{A-B} = -0.5(101325 \text{ Pa}) = \rho_{oil} a_x \Delta x_{A-B} = \left( 890 \frac{\text{kg}}{\text{m}^3} \right) a_x (10 \text{ m})$$

$$\text{solve for } a_x = -5.69 \text{ m/s}^2 \quad \text{Ans. (b)}$$

This is more than part (a), so the isobar angle must be steeper:

$$\tan \theta = \frac{-5.69}{9.81} = -0.580, \quad \text{hence } \theta_{isobar} = -30.1^\circ$$

The isobar in part (a), line CB, has the angle  $\theta_{(a)} = \tan^{-1}(-0.2) = -11.3^\circ$ .

**2.141** The same tank from Prob. 2.139 is now accelerating while rolling *up* a  $30^\circ$  inclined plane, as shown. Assuming rigid-body motion, compute (a) the acceleration  $\mathbf{a}$ , (b) whether the acceleration is up or down, and (c) the pressure at point A if the fluid is mercury at  $20^\circ\text{C}$ .

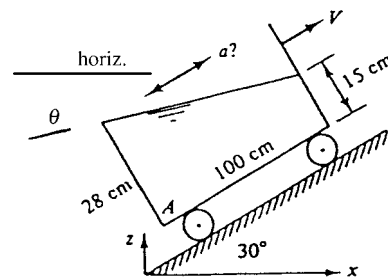


Fig. P2.141

**Solution:** The free surface is tilted at the angle  $\theta = -30^\circ + 7.41^\circ = -22.59^\circ$ . This angle must satisfy Eq. (2.55):

$$\tan \theta = \tan(-22.59^\circ) = -0.416 = a_x / (g + a_z)$$

But the  $30^\circ$  incline constrains the acceleration such that  $a_x = 0.866a$ ,  $a_z = 0.5a$ . Thus

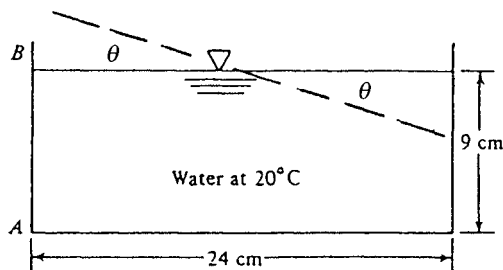
$$\tan \theta = -0.416 = \frac{0.866a}{9.81 + 0.5a}, \quad \text{solve for } \mathbf{a \approx -3.80 \frac{m}{s^2} \text{ (down) } \textit{Ans. (a, b)}}$$

The cartesian components are  $a_x = -3.29 \text{ m/s}^2$  and  $a_z = -1.90 \text{ m/s}^2$ .

(c) The distance  $\Delta S$  normal from the surface down to point A is  $(28 \cos \theta) \text{ cm}$ . Thus

$$p_A = \rho [a_x^2 + (g + a_z)^2]^{1/2} = (13550) [(-3.29)^2 + (9.81 - 1.90)^2]^{1/2} (0.28 \cos 7.41^\circ) \\ \approx \mathbf{32200 \text{ Pa (gage) } \textit{Ans. (c)}}$$

**2.142** The tank of water in Fig. P2.142 is 12 cm wide into the paper. If the tank is accelerated to the right in rigid-body motion at  $6 \text{ m/s}^2$ , compute (a) the water depth at AB, and (b) the water force on panel AB.



**Fig. P2.142**

**Solution:** From Eq. (2.55),

$$\tan \theta = a_x / g = \frac{6.0}{9.81} = 0.612, \quad \text{or } \theta \approx 31.45^\circ$$

Then surface point B on the left rises an additional  $\Delta z = 12 \tan \theta \approx 7.34 \text{ cm}$ ,

$$\text{or: water depth AB} = 9 + 7.34 \approx \mathbf{16.3 \text{ cm} \textit{ Ans. (a)}}$$

The water pressure on AB varies linearly due to gravity only, thus the water force is

$$F_{AB} = p_{CG} A_{AB} = (9790) \left( \frac{0.163}{2} \text{ m} \right) (0.163 \text{ m})(0.12 \text{ m}) \approx \mathbf{15.7 \text{ N} \textit{ Ans. (b)}}$$

**2.143** The tank of water in Fig. P2.143 is full and open to the atmosphere ( $p_{\text{atm}} = 15 \text{ psi} = 2160 \text{ psf}$ ) at point A, as shown. For what acceleration  $a_x$ , in  $\text{ft/s}^2$ , will the pressure at point B in the figure be (a) atmospheric; and (b) zero absolute (neglecting cavitation)?

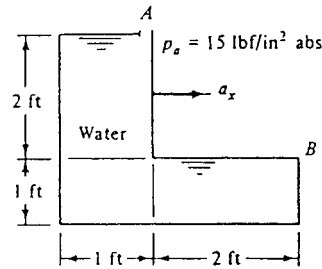


Fig. P2.143

**Solution:** (a) For  $p_A = p_B$ , the imaginary ‘free surface isobar’ should join points A and B:

$$\tan \theta_{AB} = \tan 45^\circ = 1.0 = a_x/g, \quad \text{hence } a_x = g = \mathbf{32.2 \text{ ft/s}^2} \quad \text{Ans. (a)}$$

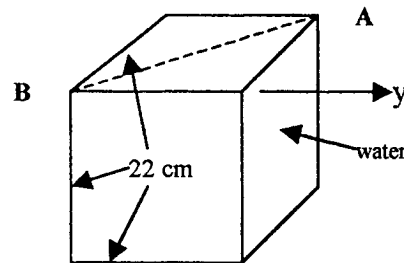
(b) For  $p_B = 0$ , the free-surface isobar must tilt even more than  $45^\circ$ , so that

$$p_B = 0 = p_A + \rho g \Delta z - \rho a_x \Delta x = 2160 + 1.94(32.2)(2) - 1.94 a_x (2),$$

$$\text{solve } a_x = \mathbf{589 \text{ ft/s}^2} \quad \text{Ans. (b)}$$

This is a very high acceleration (18 g’s) and a very steep angle,  $\theta = \tan^{-1}(589/32.2) = 87^\circ$ .

**2.144** Consider a hollow cube of side length 22 cm, full of water at  $20^\circ\text{C}$ , and open to  $p_{\text{atm}} = 1 \text{ atm}$  at top corner A. The top surface is horizontal. Determine the rigid-body accelerations for which the water at opposite top corner B will *cavitate*, for (a) horizontal, and (b) vertical motion.



**Solution:** From Table A-5 the vapor pressure of the water is 2337 Pa. (a) Thus cavitation occurs first when accelerating horizontally along the diagonal AB:

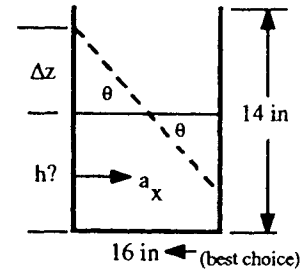
$$p_A - p_B = 101325 - 2337 = \rho a_{x,AB} \Delta L_{AB} = (998) a_{x,AB} (0.22\sqrt{2}),$$

$$\text{solve } a_{x,AB} = \mathbf{319 \text{ m/s}^2} \quad \text{Ans. (a)}$$

If we moved along the  $y$  axis shown in the figure, we would need  $a_y = 319\sqrt{2} = 451 \text{ m/s}^2$ .

(b) For *vertical* acceleration, **nothing would happen**, both points A and B would continue to be atmospheric, although the pressure at deeper points would change. *Ans.*

**2.145** A fish tank 16-in by 27-in by 14-inch deep is carried in a car which may experience accelerations as high as  $6 \text{ m/s}^2$ . Assuming rigid-body motion, estimate the maximum water depth to avoid spilling. Which is the best way to align the tank?



**Solution:** The best way is to *align the 16-inch width with the car's direction of motion*, to minimize the vertical surface change  $\Delta z$ . From Eq. (2.55) the free surface angle will be

$$\tan \theta_{\max} = a_x/g = \frac{6.0}{9.81} = 0.612, \quad \text{thus } \Delta z = \frac{16''}{2} \tan \theta = 4.9 \text{ inches } (\theta = 31.5^\circ)$$

Thus the tank should contain no more than  $14 - 4.9 \approx \mathbf{9.1 \text{ inches of water}}$ . *Ans.*

**2.146** The tank in Fig. P2.146 is filled with water and has a vent hole at point A. It is 1 m wide into the paper. Inside is a 10-cm balloon filled with helium at 130 kPa. If the tank accelerates to the right at  $5 \text{ m/s}^2$ , at what angle will the balloon lean? Will it lean to the left or to the right?

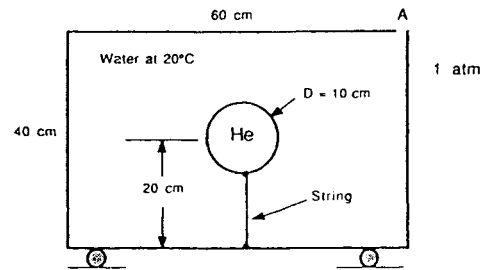
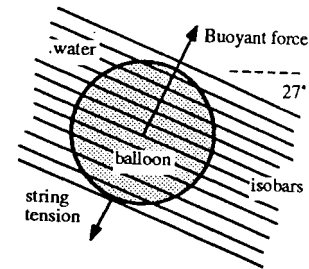


Fig. P2.146

**Solution:** The acceleration sets up pressure isobars which slant down and to the right, in both the water *and* in the helium. This means there will be a buoyancy force on the balloon up and to the right, as shown at right. It must be balanced by a string tension down and to the left. If we neglect balloon material weight, the balloon leans *up and to the right* at angle



$$\theta = \tan^{-1} \left( \frac{a_x}{g} \right) = \tan^{-1} \left( \frac{5.0}{9.81} \right) \approx 27^\circ \quad \text{Ans.}$$

measured from the vertical. This acceleration-buoyancy effect may seem counter-intuitive.

**2.147** The tank of water in Fig. P2.147 accelerates uniformly by rolling without friction down the  $30^\circ$  inclined plane. What is the angle  $\theta$  of the free surface? Can you explain this interesting result?

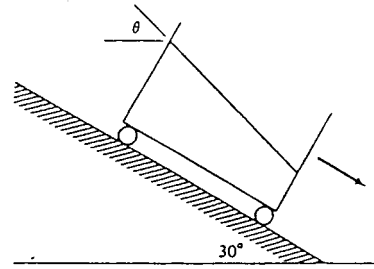


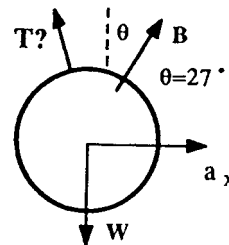
Fig. P2.147

**Solution:** If frictionless,  $\Sigma F = W \sin \theta = ma$  along the incline and thus  $a = g \sin 30^\circ = 0.5g$ .

$$\text{Thus } \tan \theta = \frac{a_x}{g + a_z} = \frac{0.5g \cos 30^\circ}{g - 0.5g \sin 30^\circ}; \text{ solve for } \theta = 30^\circ! \text{ Ans.}$$

The free surface aligns itself exactly parallel with the  $30^\circ$  incline.

**2.148** Modify Prob. 2.146 as follows: Let the 10-cm-diameter sphere be concrete (SG = 2.4) hanging by a string from the *top*. If the tank accelerates to the right at 5 m/s/s, at what angle will the balloon lean? Will it lean to the left or to the right?



**Solution:** This problem differs from 2.146 only in the heavy weight of the solid sphere, which still reacts to the acceleration but not due to an internal “pressure gradient.” The x-directed forces are not in balance. The equations of motion are

$$\Sigma F_x = m_{\text{sphere}} a_x = B_x + T_x,$$

$$\text{or: } T_x = a_x(2.4 - 1.0)(998) \frac{\pi}{6} (0.1)^3 = 3.66 \text{ N}$$

$$\Sigma F_z = 0 = B_z + T_z - W,$$

$$\text{or: } T_z = g(2.4 - 1.0)(998) \frac{\pi}{6} (0.1)^3 = 7.18 \text{ N}$$

$$\text{Thus } T = (T_x^2 + T_z^2)^{1/2} = 8.06 \text{ N acting at } \theta = \text{atan} \left( \frac{3.66}{7.18} \right) = 27^\circ$$

The concrete sphere hangs down and to the left at an angle of  $27^\circ$ . *Ans.*



**2.149** The waterwheel in Fig. P2.149 lifts water with 1-ft-diameter half-cylinder blades. The wheel rotates at 10 r/min. What is the water surface angle  $\theta$  at pt. A?

**Solution:** Convert  $\Omega = 10 \text{ r/min} = 1.05 \text{ rad/s}$ . Use an average radius  $R = 6.5 \text{ ft}$ . Then

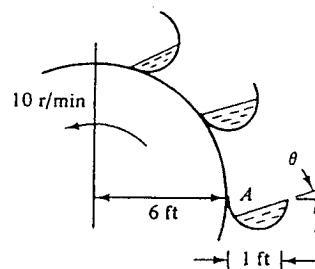


Fig. P2.149

$$a_x = \Omega^2 R = (1.05)^2 (6.5) \approx 7.13 \text{ ft/s}^2 \quad \text{toward the center}$$

$$\text{Thus } \tan \theta = a_x/g = 7.13/32.2, \quad \text{or: } \theta = 12.5^\circ \quad \text{Ans.}$$

**2.150** A cheap accelerometer can be made from the U-tube at right. If  $L = 18 \text{ cm}$  and  $D = 5 \text{ mm}$ , what will  $h$  be if  $a_x = 6 \text{ m/s}^2$ ?

**Solution:** We assume that the diameter is so small,  $D \ll L$ , that the free surface is a “point.” Then Eq. (2.55) applies, and

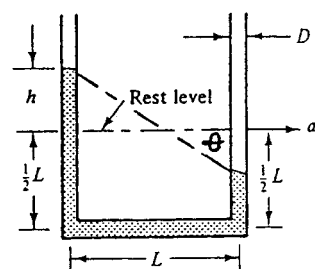


Fig. P2.150

$$\tan \theta = a_x/g = \frac{6.0}{9.81} = 0.612, \quad \text{or } \theta = 31.5^\circ$$

$$\text{Then } h = (L/2) \tan \theta = (9 \text{ cm})(0.612) = 5.5 \text{ cm} \quad \text{Ans.}$$

Since  $h = (9 \text{ cm})a_x/g$ , the scale readings are indeed linear in  $a_x$ , but I don't recommend it as an actual accelerometer, there are too many inaccuracies and disadvantages.

**2.151** The U-tube in Fig. P2.151 is open at A and closed at D. What uniform acceleration  $a_x$  will cause the pressure at point C to be atmospheric? The fluid is water.

**Solution:** If pressures at A and C are the same, the “free surface” must join these points:

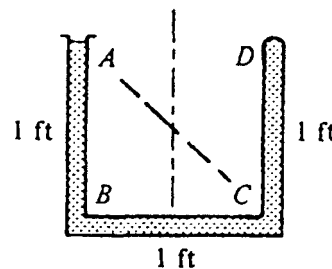
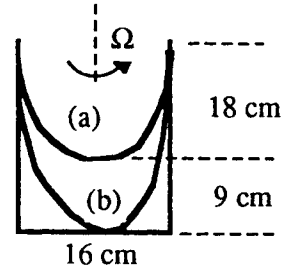


Fig. P2.151

$$\theta = 45^\circ, \quad a_x = g \tan \theta = g = 32.2 \text{ ft/s}^2 \quad \text{Ans.}$$

**2.152** A 16-cm-diameter open cylinder 27 cm high is full of water. Find the central rigid-body rotation rate for which (a) one-third of the water will spill out; and (b) the bottom center of the can will be exposed.



**Solution:** (a) One-third will spill out if the resulting paraboloid surface is 18 cm deep:

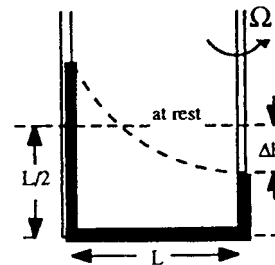
$$h = 0.18 \text{ m} = \frac{\Omega^2 R^2}{2g} = \frac{\Omega^2 (0.08 \text{ m})^2}{2(9.81)}, \text{ solve for } \Omega^2 = 552,$$

$$\Omega = 23.5 \text{ rad/s} = \mathbf{224 \text{ r/min}} \quad \text{Ans. (a)}$$

(b) The bottom is barely exposed if the paraboloid surface is 27 cm deep:

$$h = 0.27 \text{ m} = \frac{\Omega^2 (0.08 \text{ m})^2}{2(9.81)}, \text{ solve for } \Omega = 28.8 \text{ rad/s} = \mathbf{275 \text{ r/min}} \quad \text{Ans. (b)}$$

**2.153** Suppose the U-tube in Prob. 2.150 is not translated but instead is rotated about the right leg at 95 r/min. Find the level  $h$  in the left leg if  $L = 18 \text{ cm}$  and  $D = 5 \text{ mm}$ .

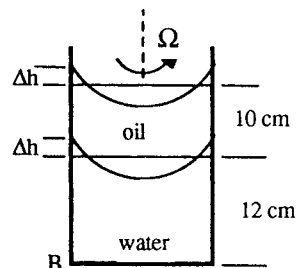


**Solution:** Convert  $\Omega = 95 \text{ r/min} = 9.95 \text{ rad/s}$ . Then “R” =  $L = 18 \text{ cm}$ , and, since  $D \ll L$ ,

$$\Delta h = \frac{\Omega^2 R^2}{4g} = \frac{(9.95)^2 (0.18)^2}{4(9.81)} = 0.082 \text{ m},$$

$$\text{thus } h_{\text{left leg}} = 9 + 8.2 = \mathbf{17.2 \text{ cm}} \quad \text{Ans.}$$

**2.154** A very deep 18-cm-diameter can has 12 cm of water, overlaid with 10 cm of SAE 30 oil. It is rotated about the center in rigid-body motion at 150 r/min. (a) What will be the shapes of the interfaces? (b) What and where will be the maximum fluid pressure?



**Solution:** Convert  $\Omega = 150 \text{ r/min} = 15.7 \text{ rad/s}$ . (a) The parabolic surfaces which result are entirely independent of the fluid density, hence both interfaces will curl up into the same-shape paraboloid, with a deflection  $\Delta h$  up at the wall and down in the center:

$$\Delta h = \frac{\Omega^2 R^2}{4g} = \frac{(15.7)^2 (0.09)^2}{4(9.81)} = 0.051 \text{ m} = \mathbf{5.1 \text{ cm}} \quad \text{Ans. (a)}$$

(b) The fluid pressure will be highest at point B in the bottom corner. We can compute this by moving straight down through the oil and water at the wall, with gravity only:

$$\begin{aligned} p_B &= \rho_{\text{oil}} g \Delta z_{\text{oil}} + \rho_{\text{water}} g \Delta z_{\text{water}} \\ &= (891)(9.81)(0.1 \text{ m}) + (998)(9.81)(0.051 + 0.12 \text{ m}) = \mathbf{2550 \text{ Pa (gage)}} \quad \text{Ans. (b)} \end{aligned}$$

**2.155** For what uniform rotation rate in r/min about axis C will the U-tube fluid in Fig. P2.155 take the position shown? The fluid is mercury at 20°C.

**Solution:** Let  $h_o$  be the height of the free surface at the centerline. Then, from Eq. (2.64),

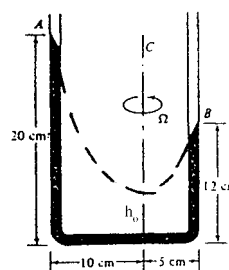


Fig. P2.155

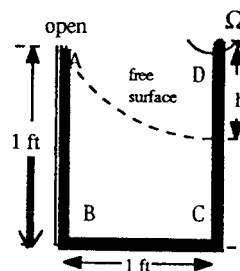
$$z_B = h_o + \frac{\Omega^2 R_B^2}{2g}; \quad z_A = h_o + \frac{\Omega^2 R_A^2}{2g}; \quad R_B = 0.05 \text{ m} \quad \text{and} \quad R_A = 0.1 \text{ m}$$

$$\text{Subtract: } z_A - z_B = 0.08 \text{ m} = \frac{\Omega^2}{2(9.81)} [(0.1)^2 - (0.05)^2],$$

$$\text{solve } \Omega = 14.5 \frac{\text{rad}}{\text{s}} = \mathbf{138 \frac{\text{r}}{\text{min}}} \quad \text{Ans.}$$

The fact that the fluid is mercury does not enter into this “kinematic” calculation.

**2.156** Suppose the U-tube of Prob. 2.151 is rotated about axis DC. If the fluid is water at 122°F and atmospheric pressure is 2116 psfa, at what rotation rate will the fluid begin to vaporize? At what point in the tube will this happen?



**Solution:** At  $122^\circ\text{F} = 50^\circ\text{C}$ , from Tables A-1 and A-5, for water,  $\rho = 988 \text{ kg/m}^3$  (or  $1.917 \text{ slug/ft}^3$ ) and  $p_v = 12.34 \text{ kPa}$  (or  $258 \text{ psf}$ ). When spinning around DC, the free surface comes down from point A to a position *below* point D, as shown. Therefore the fluid pressure is lowest at point D (*Ans.*). With  $h$  as shown in the figure,

$$p_D = p_{\text{vap}} = 258 = p_{\text{atm}} - \rho gh = 2116 - 1.917(32.2)h, \quad h = \Omega^2 R^2 / (2g)$$

Solve for  $h \approx 30.1 \text{ ft}$  (!) Thus the drawing is wildly distorted and the dashed line falls **far below** point C! (The solution is correct, however.)

$$\text{Solve for } \Omega^2 = 2(32.2)(30.1)/(1 \text{ ft})^2 \quad \text{or: } \Omega = 44 \text{ rad/s} = \mathbf{420 \text{ rev/min.}} \quad \text{Ans.}$$

**2.157** The  $45^\circ$  V-tube in Fig. P2.157 contains water and is open at A and closed at C. (a) For what rigid-body rotation rate will the pressure be equal at points B and C? (b) For the condition of part (a), at what point in leg BC will the pressure be a minimum?

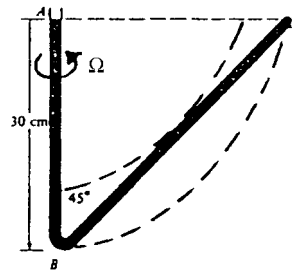


Fig. P2.157

**Solution:** (a) If pressures are equal at B and C, they must lie on a constant-pressure paraboloid surface as sketched in the figure. Taking  $z_B = 0$ , we may use Eq. (2.64):

$$z_C = 0.3 \text{ m} = \frac{\Omega^2 R^2}{2g} = \frac{\Omega^2 (0.3)^2}{2(9.81)}, \quad \text{solve for } \Omega = 8.09 \frac{\text{rad}}{\text{s}} = \mathbf{77 \frac{\text{rev}}{\text{min}}} \quad \text{Ans. (a)}$$

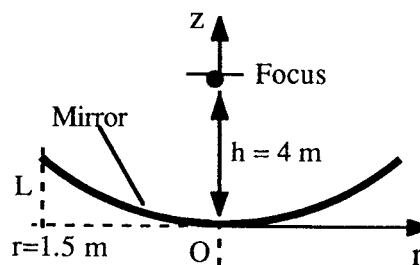
(b) The minimum pressure in leg BC occurs where the highest paraboloid pressure contour is tangent to leg BC, as sketched in the figure. This family of paraboloids has the formula

$$z = z_o + \frac{\Omega^2 r^2}{2g} = r \tan 45^\circ, \quad \text{or: } z_o + 3.333r^2 - r = 0 \quad \text{for a pressure contour}$$

$$\text{The minimum occurs when } dz/dr = 0, \quad \text{or } r \approx \mathbf{0.15 \text{ m}} \quad \text{Ans. (b)}$$

The minimum pressure occurs *halfway between points B and C*.

**2.158\*** It is desired to make a 3-m-diameter parabolic telescope mirror by rotating molten glass in rigid-body motion until the desired shape is achieved and then cooling the glass to a solid. The focus of the mirror is to be 4 m from the mirror, measured along the centerline. What is the proper mirror rotation rate, in rev/min?



**Solution:** We have to review our math book, or Mark's Manual, to recall that the *focus*  $F$  of a parabola is the point for which all points on the parabola are equidistant from both the focus and a so-called "directrix" line (which is one focal length below the mirror). For the focal length  $h$  and the  $z$ - $r$  axes shown in the figure, the equation of the parabola is given by  $r^2 = 4hz$ , with  $h = 4$  m for our example. Meanwhile the equation of the free-surface of the liquid is given by  $z = r^2\Omega^2/(2g)$ . Set these two equal to find the proper rotation rate:

$$z = \frac{r^2\Omega^2}{2g} = \frac{r^2}{4h}, \quad \text{or:} \quad \Omega^2 = \frac{g}{2h} = \frac{9.81}{2(4)} = 1.226$$

$$\text{Thus } \Omega = 1.107 \frac{\text{rad}}{\text{s}} \left( \frac{60}{2\pi} \right) = \mathbf{10.6 \text{ rev/min}} \quad \text{Ans.}$$

The focal point  $F$  is far above the mirror itself. If we put in  $r = 1.5$  m and calculate the mirror depth "L" shown in the figure, we get  $L \approx 14$  centimeters.

**2.159** The three-legged manometer in Fig. P2.159 is filled with water to a depth of 20 cm. All tubes are long and have equal small diameters. If the system spins at angular velocity  $\Omega$  about the central tube, (a) derive a formula to find the change of height in the tubes; (b) find the height in cm in each tube if  $\Omega = 120$  rev/min. [*HINT*: The central tube must supply water to *both* the outer legs.]

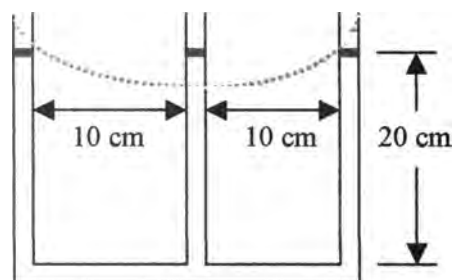


Fig. P2.159

**Solution:** (a) The free-surface during rotation is visualized as the **red** dashed line in Fig. P2.159. The outer right and left legs experience an increase which is one-half that of the central leg, or  $\Delta h_o = \Delta h_c/2$ . The total displacement between outer and center menisci is, from Eq. (2.64) and Fig. 2.23, equal to  $\Omega^2 R^2/(2g)$ . The center meniscus

falls two-thirds of this amount and feeds the outer tubes, which each rise one-third of this amount above the rest position:

$$\Delta h_{outer} = \frac{1}{3} \Delta h_{total} = \frac{\Omega^2 R^2}{6g} \quad \Delta h_{center} = -\frac{2}{3} \Delta h_{total} = -\frac{\Omega^2 R^2}{3g} \quad \text{Ans. (a)}$$

For the particular case  $R = 10 \text{ cm}$  and  $\Omega = 120 \text{ r/min} = (120)(2\pi/60) = 12.57 \text{ rad/s}$ , we obtain

$$\frac{\Omega^2 R^2}{2g} = \frac{(12.57 \text{ rad/s})^2 (0.1 \text{ m})^2}{2(9.81 \text{ m/s}^2)} = 0.0805 \text{ m};$$

$$\Delta h_o \approx \mathbf{0.027 \text{ m (up)}} \quad \Delta h_c \approx \mathbf{-0.054 \text{ m (down)}} \quad \text{Ans. (b)}$$


---

**FUNDAMENTALS OF ENGINEERING EXAM PROBLEMS: Answers**

FE-2.1 A gage attached to a pressurized nitrogen tank reads a gage pressure of 28 inches of mercury. If atmospheric pressure is 14.4 psia, what is the absolute pressure in the tank?

- (a) 95 kPa (b) 99 kPa (c) 101 kPa (d) **194 kPa** (e) 203 kPa

FE-2.2 On a sea-level standard day, a pressure gage, moored below the surface of the ocean ( $SG = 1.025$ ), reads an absolute pressure of 1.4 MPa. How deep is the instrument?

- (a) 4 m (b) **129 m** (c) 133 m (d) 140 m (e) 2080 m

FE-2.3 In Fig. FE-2.3, if the oil in region B has  $SG = 0.8$  and the absolute pressure at point A is 1 atmosphere, what is the absolute pressure at point B?

- (a) 5.6 kPa (b) 10.9 kPa (c) **106.9 kPa**  
(d) 112.2 kPa (e) 157.0 kPa

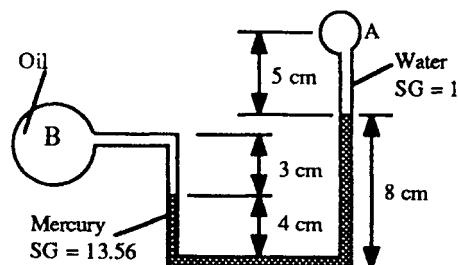


Fig. FE-2.3

FE-2.4 In Fig. FE-2.3, if the oil in region B has  $SG = 0.8$  and the absolute pressure at point B is 14 psia, what is the absolute pressure at point A?

- (a) 11 kPa (b) 41 kPa (c) 86 kPa (d) **91 kPa** (e) 101 kPa

FE-2.5 A tank of water ( $SG = 1.0$ ) has a gate in its vertical wall 5 m high and 3 m wide. The top edge of the gate is 2 m below the surface. What is the hydrostatic force on the gate?

- (a) 147 kN (b) 367 kN (c) 490 kN (d) **661 kN** (e) 1028 kN

FE-2.6 In Prob. FE-2.5 above, how far below the surface is the center of pressure of the hydrostatic force?

- (a) 4.50 m (b) 5.46 m (c) 6.35 m (d) 5.33 m (e) **4.96 m**

FE-2.7 A solid 1-m-diameter sphere floats at the interface between water ( $SG = 1.0$ ) and mercury ( $SG = 13.56$ ) such that 40% is in the water. What is the specific gravity of the sphere?

- (a) 6.02 (b) 7.28 (c) 7.78 (d) **8.54** (e) 12.56

FE-2.8 A 5-m-diameter balloon contains helium at 125 kPa absolute and  $15^\circ\text{C}$ , moored in sea-level standard air. If the gas constant of helium is  $2077 \text{ m}^2/(\text{s}^2\cdot\text{K})$  and balloon material weight is neglected, what is the net lifting force of the balloon?

- (a) 67 N (b) 134 N (c) 522 N (d) **653 N** (e) 787 N

FE-2.9 A square wooden ( $SG = 0.6$ ) rod, 5 cm by 5 cm by 10 m long, floats vertically in water at  $20^\circ\text{C}$  when 6 kg of steel ( $SG = 7.84$ ) are attached to the lower end. How high above the water surface does the wooden end of the rod protrude?

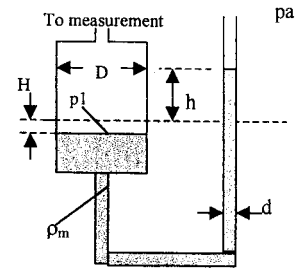
- (a) 0.6 m (b) 1.6 m (c) **1.9 m** (d) 2.4 m (e) 4.0 m

FE-2.10 A floating body will always be stable when its

- (a) CG is above the center of buoyancy (b) center of buoyancy is below the waterline  
(c) center of buoyancy is above its metacenter (d) metacenter is above the center of buoyancy  
(e) **metacenter is above the CG**

## COMPREHENSIVE PROBLEMS

**C2.1** Some manometers are constructed as in the figure at right, with one large reservoir and one small tube open to the atmosphere. We can then neglect movement of the reservoir level. If the reservoir is not large, its level will move, as in the figure. Tube height  $h$  is measured from the zero-pressure level, as shown.



(a) Let the reservoir pressure be high, as in the Figure, so its level goes down. Write an exact Expression for  $p_{1\text{gage}}$  as a function of  $h$ ,  $d$ ,  $D$ , and gravity  $g$ . (b) Write an approximate expression for  $p_{1\text{gage}}$ , neglecting the movement of the reservoir. (c) Suppose  $h = 26$  cm,  $p_a = 101$  kPa, and  $\rho_m = 820$  kg/m<sup>3</sup>. Estimate the ratio ( $D/d$ ) required to keep the error in (b) less than 1.0% and also < 0.1%. Neglect surface tension.

**Solution:** Let  $H$  be the downward movement of the reservoir. If we neglect air density, the pressure difference is  $p_1 - p_a = \rho_m g(h + H)$ . But volumes of liquid must balance:

$$\frac{\pi}{4} D^2 H = \frac{\pi}{4} d^2 h, \quad \text{or:} \quad H = (d/D)^2 h$$

Then the pressure difference (exact except for air density) becomes

$$p_1 - p_a = p_{1\text{gage}} = \rho_m g h (1 + d^2/D^2) \quad \text{Ans. (a)}$$

If we ignore the displacement  $H$ , then  $p_{1\text{gage}} \approx \rho_m g h$  Ans. (b)

(c) For the given numerical values,  $h = 26$  cm and  $\rho_m = 820$  kg/m<sup>3</sup> are irrelevant, all that matters is the ratio  $d/D$ . That is,

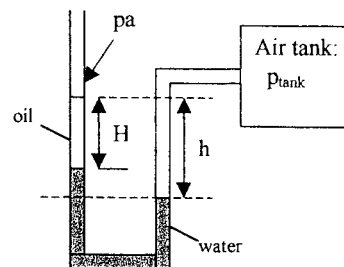
$$\text{Error } E = \frac{\Delta p_{\text{exact}} - \Delta p_{\text{approx}}}{\Delta p_{\text{exact}}} = \frac{(d/D)^2}{1 + (d/D)^2}, \quad \text{or:} \quad D/d = \sqrt{(1-E)/E}$$

For  $E = 1\%$  or 0.01,  $D/d = [(1 - 0.01)/0.01]^{1/2} \geq \mathbf{9.95}$  Ans. (c-1%)

For  $E = 0.1\%$  or 0.001,  $D/d = [(1 - 0.001)/0.001]^{1/2} \geq \mathbf{31.6}$  Ans. (c-0.1%)

**C2.2** A prankster has added oil, of specific gravity  $SG_o$ , to the left leg of the manometer at right. Nevertheless, the U-tube is still to be used to measure the pressure in the air tank. (a) Find an expression for  $h$  as a function of  $H$  and other parameters in the problem.

(b) Find the special case of your result when  $p_{\text{tank}} = p_a$ .  
 (c) Suppose  $H = 5$  cm,  $p_a = 101.2$  kPa,  $SG_o = 0.85$ , and  $p_{\text{tank}}$  is 1.82 kPa higher than  $p_a$ . Calculate  $h$  in cm, ignoring surface tension and air density effects.





**Solution:** Equate pressures at level  $i$  in the tube:

$$p_i = p_a + \rho g H + \rho_w g (h - H) = p_{\text{tank}},$$

$$\rho = SG_o \rho_w \quad (\text{ignore the column of air in the right leg})$$

$$\text{Solve for: } h = \frac{p_{\text{tk}} - p_a}{\rho_w g} + H(1 - SG_o) \quad \text{Ans. (a)}$$

If  $p_{\text{tank}} = p_a$ , then

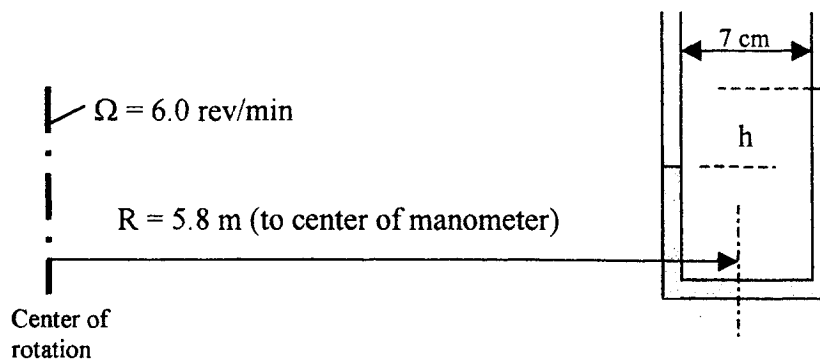
$$h = H(1 - SG_o) \quad \text{Ans. (b)}$$

(c) For the particular numerical values given above, the answer to (a) becomes

$$h = \frac{1820 \text{ Pa}}{998(9.81)} + 0.05(1 - 0.85) = 0.186 + 0.0075 = 0.193 \text{ m} = \mathbf{19.3 \text{ cm}} \quad \text{Ans. (c)}$$

Note that this result is not affected by the actual value of atmospheric pressure.

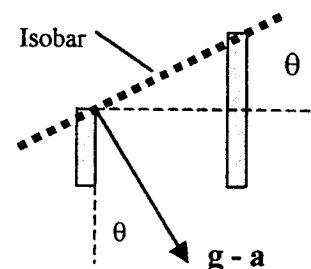
**C2.3** Professor F. Dynamics, riding the merry-go-round with his son, has brought along his U-tube manometer. (You never know when a manometer might come in handy.) As shown in Fig. C2.2, the merry-go-round spins at constant angular velocity and the manometer legs are 7 cm apart. The manometer center is 5.8 m from the axis of rotation. Determine the height difference  $h$  in two ways: (a) approximately, by assuming rigid body translation with  $\mathbf{a}$  equal to the average manometer acceleration; and (b) exactly, using rigid-body rotation theory. How good is the approximation?



**Solution:** (a) Approximate: The average acceleration of the manometer is  $R_{\text{avg}} \Omega^2 = 5.8 [6(2\pi/60)]^2 = 2.29 \text{ rad/s}$  toward the center of rotation, as shown. Then

$$\tan(\theta) = a/g = 2.29/9.81 = h/(7 \text{ cm}) = 0.233$$

$$\text{Solve for } h = \mathbf{1.63 \text{ cm}} \quad \text{Ans. (a)}$$



(b) Exact: The isobar in the figure at right would be on the parabola  $z = C + r^2\Omega^2/(2g)$ , where  $C$  is a constant. Apply this to the left leg ( $z_1$ ) and right leg ( $z_2$ ). As above, the rotation rate is  $\Omega = 6.0 \cdot (2\pi/60) = 0.6283$  rad/s. Then

$$h = z_2 - z_1 = \frac{\Omega^2}{2g}(r_2^2 - r_1^2) = \frac{(0.6283)^2}{2(9.81)} [(5.8 + 0.035)^2 - (5.8 - 0.035)^2]$$

$$= \mathbf{0.0163 \text{ m}} \quad \text{Ans. (b)}$$

This is nearly identical to the approximate answer (a), because  $R \gg \Delta r$ .

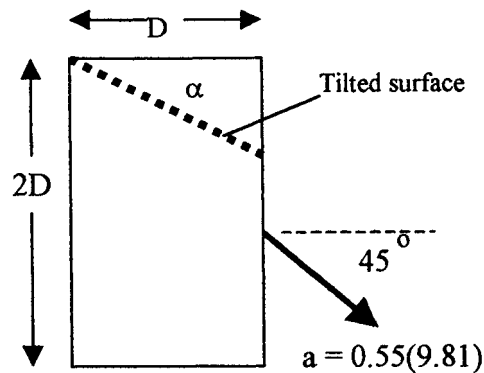
**C2.4** A student sneaks a glass of cola onto a roller coaster ride. The glass is cylindrical, twice as tall as it is wide, and filled to the brim. He wants to know what percent of the cola he should drink before the ride begins, so that none of it spills during the big drop, in which the roller coaster achieves 0.55-g acceleration at a  $45^\circ$  angle below the horizontal. Make the calculation for him, neglecting sloshing and assuming that the glass is vertical at all times.

**Solution:** We have both horizontal and vertical acceleration. Thus the angle of tilt  $\alpha$  is

$$\tan \alpha = \frac{a_x}{g + a_z} = \frac{0.55g \cos 45^\circ}{g - 0.55g \sin 45^\circ} = 0.6364$$

Thus  $\alpha = 32.47^\circ$ . The tilted surface strikes the centerline at  $R \tan \alpha = 0.6364R$  below the top. So the student should drink the cola until its rest position is  $0.6364R$  below the top. The percentage drop in liquid level (and therefore liquid volume) is

$$\% \text{ removed} = \frac{0.6364R}{4R} = 0.159 \quad \text{or} \quad \mathbf{15.9\%} \quad \text{Ans.}$$



**C2.5** Dry adiabatic lapse rate is defined as  $\text{DALR} = -dT/dz$  when  $T$  and  $p$  vary isentropically. Assuming  $T = Cp^a$ , where  $a = (\gamma - 1)/\gamma$ ,  $\gamma = c_p/c_v$ , (a) show that  $\text{DALR} = g(\gamma - 1)/(\gamma R)$ ,  $R$  = gas constant; and (b) calculate DALR for air in units of  $^\circ\text{C}/\text{km}$ .

**Solution:** Write  $T(p)$  in the form  $T/T_o = (p/p_o)^a$  and differentiate:

$$\frac{dT}{dz} = T_o a \left( \frac{p}{p_o} \right)^{a-1} \frac{1}{p_o} \frac{dp}{dz}, \quad \text{But for the hydrostatic condition: } \frac{dp}{dz} = -\rho g$$

Substitute  $\rho = p/RT$  for an ideal gas, combine above, and rewrite:

$$\frac{dT}{dz} = -\frac{T_o}{p_o} a \left(\frac{p}{p_o}\right)^{a-1} \frac{p}{RT} g = -\frac{ag}{R} \left(\frac{T_o}{T}\right) \left(\frac{p}{p_o}\right)^a. \quad \text{But: } \frac{T_o}{T} \left(\frac{p}{p_o}\right)^a = 1 \text{ (isentropic)}$$

Therefore, finally,

$$-\frac{dT}{dz} = DALR = \frac{ag}{R} = \frac{(\gamma-1)g}{\gamma R} \quad \text{Ans. (a)}$$

(b) Regardless of the actual air temperature and pressure, the DALR for **air** equals

$$DALR = -\frac{dT}{dz} \Big|_s = \frac{(1.4-1)(9.81 \text{ m/s}^2)}{1.4(287 \text{ m}^2/\text{s}^2/^\circ\text{C})} = 0.00977 \frac{^\circ\text{C}}{\text{m}} = \mathbf{9.77 \frac{^\circ\text{C}}{\text{km}}} \quad \text{Ans. (b)}$$

**C2.6** Use the approximate pressure-density relation for a “soft” liquid,

$$dp = a^2 d\rho, \quad \text{or} \quad p = p_o + a^2(\rho - \rho_o)$$

to derive a formula for the density distribution  $\rho(z)$  and pressure distribution  $p(z)$  in a column of soft liquid. Then find the force  $F$  on a vertical wall of width  $b$ , extending from  $z = 0$  down to  $z = -h$ , and compare with the incompressible result  $F = \rho_o g h^2 b/2$ .

**Solution:** Introduce this  $p(\rho)$  relation into the hydrostatic relation (2.18) and integrate:

$$dp = a^2 d\rho = -\gamma dz = -\rho g dz, \quad \text{or: } \int_{\rho_o}^{\rho} \frac{d\rho}{\rho} = -\int_0^z \frac{g dz}{a^2}, \quad \text{or: } \rho = \rho_o e^{-gz/a^2} \quad \text{Ans.}$$

assuming constant  $a^2$ . Substitute into the  $p(\rho)$  relation to obtain the pressure distribution:

$$p \approx p_o + a^2 \rho_o [e^{-gz/a^2} - 1] \quad (1)$$

Since  $p(z)$  increases with  $z$  at a greater than linear rate, the center of pressure will always be a little lower than predicted by linear theory (Eq. 2.44). Integrate Eq. (1) above, neglecting  $p_o$ , into the pressure force on a vertical plate extending from  $z = 0$  to  $z = -h$ :

$$F = -\int_0^{-h} p b dz = \int_{-h}^0 a^2 \rho_o (e^{-gz/a^2} - 1) b dz = \mathbf{ba^2 \rho_o \left[ \frac{a^2}{g} (e^{gh/a^2} - 1) - h \right]} \quad \text{Ans.}$$

In the limit of small depth change relative to the “softness” of the liquid,  $h \ll a^2/g$ , this reduces to the linear formula  $F = \rho_o g h^2 b/2$  by expanding the exponential into the first three terms of its series. For “hard” liquids, the difference in the two formulas is negligible. For example, for water ( $a \approx 1490 \text{ m/s}$ ) with  $h = 10 \text{ m}$  and  $b = 1 \text{ m}$ , the linear formula predicts  $F = 489500 \text{ N}$  while the exponential formula predicts  $F = 489507 \text{ N}$ .

## Chapter 3 • Integral Relations for a Control Volume

3.1 Discuss Newton's second law (the linear momentum relation) in these three forms:

$$\Sigma \mathbf{F} = m\mathbf{a} \quad \Sigma \mathbf{F} = \frac{d}{dt}(m\mathbf{V}) \quad \Sigma \mathbf{F} = \frac{d}{dt} \left( \int_{system} \mathbf{V} \rho \, dv \right)$$

**Solution:** These questions are just to get the students thinking about the basic laws of mechanics. They are valid and equivalent for constant-mass systems, and we can make use of all of them in certain fluids problems, e.g. the #1 form for small elements, #2 form for rocket propulsion, but the #3 form is control-volume related and thus the most popular in this chapter.

---

3.2 Consider the angular-momentum relation in the form

$$\Sigma \mathbf{M}_O = \frac{d}{dt} \left[ \int_{system} (\mathbf{r} \times \mathbf{V}) \rho \, dv \right]$$

What does  $\mathbf{r}$  mean in this relation? Is this relation valid in both solid and fluid mechanics? Is it related to the *linear*-momentum equation (Prob. 3.1)? In what manner?

**Solution:** These questions are just to get the students thinking about angular momentum versus linear momentum. One might forget that  $\mathbf{r}$  is the position vector from the moment-center  $O$  to the elements  $\rho \, dv$  where momentum is being summed. Perhaps  $\mathbf{r}_O$  is a better notation.

---

3.3 For steady laminar flow through a long tube (see Prob. 1.12), the axial velocity distribution is given by  $u = C(R^2 - r^2)$ , where  $R$  is the tube outer radius and  $C$  is a constant. Integrate  $u(r)$  to find the total volume flow  $Q$  through the tube.

**Solution:** The area element for this axisymmetric flow is  $dA = 2\pi r \, dr$ . From Eq. (3.7),

$$Q = \int u \, dA = \int_0^R C(R^2 - r^2) 2\pi r \, dr = \frac{\pi}{2} \mathbf{C} R^4 \quad \text{Ans.}$$

---

**3.4** Discuss whether the following flows are steady or unsteady: (a) flow near an automobile moving at 55 m/h; (b) flow of the wind past a water tower; (c) flow in a pipe as the downstream valve is opened at a uniform rate; (d) river flow over a spillway of a dam; and (e) flow in the ocean beneath a series of uniform propagating surface waves.

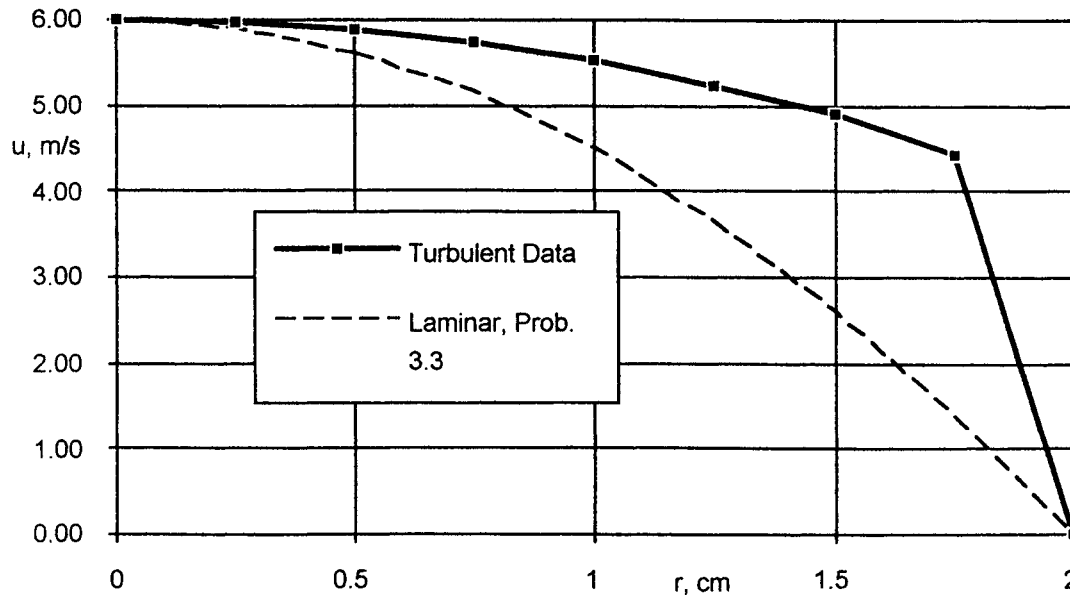
**Solution:** (a) *steady* (except for vortex shedding) in a frame fixed to the auto.  
 (b) *steady* (except for vortex shedding) in a frame fixed to the water tower.  
 (c) *unsteady* by its very nature (accelerating flow).  
 (d) *steady* except for fluctuating turbulence.  
 (e) Uniform periodic waves are *steady* when viewed in a frame fixed to the waves.

**3.5** A theory proposed by S. I. Pai in 1953 gives the following velocity values  $u(r)$  for turbulent (high-Reynolds number) airflow in a 4-cm-diameter tube:

$r$ , cm	0	0.25	0.5	0.75	1.0	1.25	1.5	1.75	2.0
$u$ , m/s	6.00	5.97	5.88	5.72	5.51	5.23	4.89	4.43	0.00

Comment on these data vis-a-vis laminar flow, Prof. 3.3. Estimate, as best you can, the total volume flow  $Q$  through the tube, in  $\text{m}^3/\text{s}$ .

**Solution:** The data can be plotted in the figure below.



As seen in the figure, the flat (turbulent) velocities do not resemble the parabolic laminar-flow profile of Prob. 3.3. (The discontinuity at  $r = 1.75$  cm is an artifact—we need more

data for  $1.75 < r < 2.0$  cm.) The volume flow,  $Q = \int u(2\pi r)dr$ , can be estimated by a numerical quadrature formula such as Simpson's rule. Here there are nine data points:

$$Q = 2\pi(r_1u_1 + 4r_2u_2 + 2r_3u_3 + 4r_4u_4 + 2r_5u_5 + 4r_6u_6 + 2r_7u_7 + 4r_8u_8 + r_9u_9) \left( \frac{\Delta r}{3} \right)$$

For the given data,  $Q \approx 0.0059 \text{ m}^3/\text{s}$  Ans.

**3.6** When a gravity-driven liquid jet issues from a slot in a tank, as in Fig. P3.6, an approximation for the exit velocity distribution is  $u \approx \sqrt{2g(h-z)}$ , where  $h$  is the depth of the jet centerline. Near the slot, the jet is horizontal, two-dimensional, and of thickness  $2L$ , as shown. Find a general expression for the total volume flow  $Q$  issuing from the slot; then take the limit of your result if  $L \ll h$ .

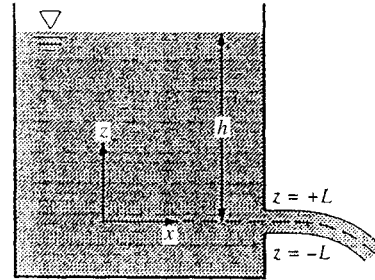


Fig. P3.6

**Solution:** Let the slot width be  $b$  into the paper. Then the volume flow from Eq. (3.7) is

$$Q = \int u dA = \int_{-L}^{+L} [2g(h-z)]^{1/2} b dz = \frac{2b}{3} \sqrt{(2g)[(h+L)^{3/2} - (h-L)^{3/2}]} \text{ Ans.}$$

In the limit of  $L \ll h$ , this formula reduces to  $Q \approx (2Lb)\sqrt{(2gh)}$  Ans.

**3.7** In Chap. 8 a theory gives the velocities for flow past a cylinder:

$$v_r = U \cos\theta(1 - R^2/r^2)$$

$$v_\theta = -U \sin\theta(1 + R^2/r^2)$$

Compute the volume flow  $Q$  passing through surface CC in the figure.

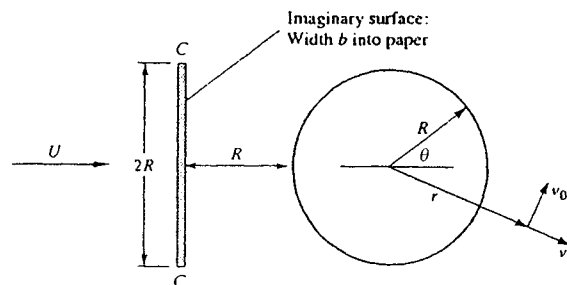


Fig. P3.7

**Solution:** This problem is quite laborious and illustrates the difficulty of working with polar velocity components passing through a cartesian (plane) surface. From Eq. (3.7),

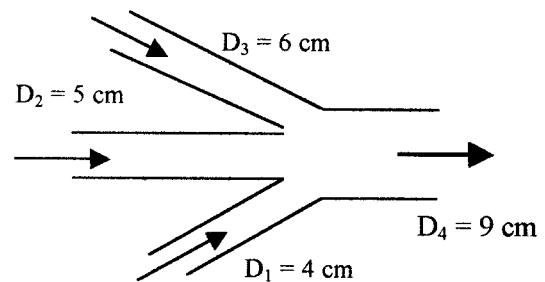
$$Q = \int (\mathbf{V} \cdot \mathbf{n}) dA = \int_{-R}^{+R} (v_r \cos \theta - v_\theta \sin \theta) b dy, \quad \text{where } y = r \sin \theta$$

We have to integrate over surface CC, where  $r$  varies from  $2R$  to  $2.24R$  and  $\theta$  varies from  $153.4^\circ$  to  $206.6^\circ$ . Inserting the velocity components as given we obtain

$$Q = \int_{-R}^{+R} [U \cos^2 \theta (1 - R^2/r^2) + U \sin^2 \theta (1 + R^2/r^2)] b dy \Big|_{x=-2R} = \mathbf{1.6URb} \quad \text{Ans.}$$

The integration is messy. In Chaps. 4&8 we find the result easily using the stream function.

**3.8** Three pipes steadily deliver water at  $20^\circ\text{C}$  to a large exit pipe in Fig. P3.8. The velocity  $V_2 = 5 \text{ m/s}$ , and the exit flow rate  $Q_4 = 120 \text{ m}^3/\text{h}$ . Find (a)  $V_1$ ; (b)  $V_3$ ; and (c)  $V_4$  if it is known that increasing  $Q_3$  by 20% would increase  $Q_4$  by 10%.



**Fig. P3.8**

**Solution:** (a) For steady flow we have  $Q_1 + Q_2 + Q_3 = Q_4$ , or

$$V_1 A_1 + V_2 A_2 + V_3 A_3 = V_4 A_4 \quad (1)$$

Since  $0.2Q_3 = 0.1Q_4$ , and  $Q_4 = (120 \text{ m}^3/\text{h})(\text{h}/3600 \text{ s}) = 0.0333 \text{ m}^3/\text{s}$ ,

$$V_3 = \frac{Q_4}{2A_3} = \frac{(0.0333 \text{ m}^3/\text{s})}{\frac{\pi}{2}(0.06^2)} = \mathbf{5.89 \text{ m/s}} \quad \text{Ans. (b)}$$

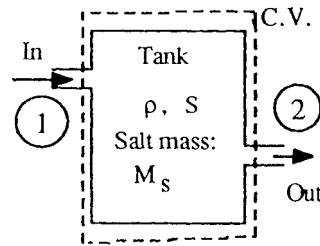
Substituting into (1),

$$V_1 \left( \frac{\pi}{4} \right) (0.04^2) + (5) \left( \frac{\pi}{4} \right) (0.05^2) + (5.89) \left( \frac{\pi}{4} \right) (0.06^2) = 0.0333 \quad \mathbf{V_1 = 5.45 \text{ m/s}} \quad \text{Ans. (a)}$$

From mass conservation,  $Q_4 = V_4 A_4$

$$(0.0333 \text{ m}^3/\text{s}) = V_4 (\pi) (0.06^2) / 4 \quad \mathbf{V_4 = 5.24 \text{ m/s}} \quad \text{Ans. (c)}$$

**3.9** A laboratory test tank contains seawater of salinity  $S$  and density  $\rho$ . Water enters the tank at conditions  $(S_1, \rho_1, A_1, V_1)$  and is assumed to mix immediately in the tank. Tank water leaves through an outlet  $A_2$  at velocity  $V_2$ . If salt is a “conservative” property (neither created nor destroyed), use the Reynolds transport theorem to find an expression for the rate of change of salt mass  $M_{\text{salt}}$  within the tank.



**Solution:** By definition, salinity  $S = \rho_{\text{salt}}/\rho$ . Since salt is a “conservative” substance (not consumed or created in this problem), the appropriate control volume relation is

$$\frac{dM_{\text{salt}}}{dt}\Big|_{\text{system}} = \frac{d}{dt} \left( \int_{\text{CV}} \rho_s \, dv \right) + S\dot{m}_2 - S_1\dot{m}_1 = 0$$

$$\text{or: } \frac{dM_s}{dt}\Big|_{\text{CV}} = S_1\rho_1A_1V_1 - S\rho A_2V_2 \quad \text{Ans.}$$

**3.10** Water flowing through an 8-cm-diameter pipe enters a porous section, as in Fig. P3.10, which allows a uniform radial velocity  $v_w$  through the wall surfaces for a distance of 1.2 m. If the entrance average velocity  $V_1$  is 12 m/s, find the exit velocity  $V_2$  if (a)  $v_w = 15$  cm/s out of the pipe walls; (b)  $v_w = 10$  cm/s into the pipe. (c) What value of  $v_w$  will make  $V_2 = 9$  m/s?

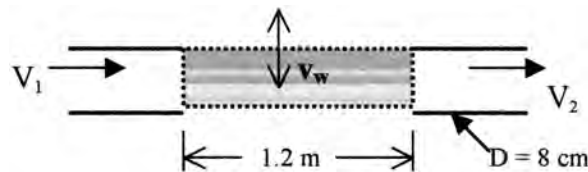


Fig. P3.10

**Solution:** (a) For a suction velocity of  $v_w = 0.15$  m/s, and a cylindrical suction surface area,

$$A_w = 2\pi(0.04)(1.2) = 0.3016 \, \text{m}^2$$

$$Q_1 = Q_w + Q_2$$

$$(12)(\pi)(0.08^2)/4 = (0.15)(0.3016) + V_2(\pi)(0.08^2)/4 \quad \mathbf{V_2 = 3 \, \text{m/s}} \quad \text{Ans. (a)}$$

(b) For a smaller wall velocity,  $v_w = 0.10$  m/s,

$$(12)(\pi)(0.08^2)/4 = (0.10)(0.3016) + V_2(\pi)(0.08^2)/4 \quad \mathbf{V_2 = 6 \, \text{m/s}} \quad \text{Ans. (b)}$$



(c) Setting the outflow  $V_2$  to 9 m/s, the wall suction velocity is,

$$(12)(\pi)(0.08^2)/4 = (v_w)(0.3016) + (9)(\pi)(0.08^2)/4 \quad \mathbf{v_w = 0.05 \text{ m/s} = 5 \text{ cm/s out}}$$

**3.11** A room contains dust at uniform concentration  $C = \rho_{\text{dust}}/\rho$ . It is to be cleaned by introducing fresh air at an inlet section  $A_i$ ,  $V_i$  and exhausting the room air through an outlet section. Find an expression for the rate of change of dust mass in the room.

**Solution:** This problem is very similar to Prob. 3.9 on the previous page, except that here  $C_i = 0$  (dustfree air). Refer to the figure in Prob. 3.9. The dust mass relation is

$$\frac{dM_{\text{dust}}}{dt} \Big|_{\text{system}} = 0 = \frac{d}{dt} \left( \int_{\text{CV}} \rho_{\text{dust}} \, dv \right) + C_{\text{out}} \dot{m}_{\text{out}} - C_{\text{in}} \dot{m}_{\text{in}},$$

or, since  $C_{\text{in}} = 0$ , we obtain  $\frac{dM_{\text{dust}}}{dt} \Big|_{\text{CV}} = -C\rho A_o V_o$  Ans.

To complete the analysis, we would need to make an *overall* fluid mass balance.

**3.12** The pipe flow in Fig. P3.12 fills a cylindrical tank as shown. At time  $t = 0$ , the water depth in the tank is 30 cm. Estimate the time required to fill the remainder of the tank.

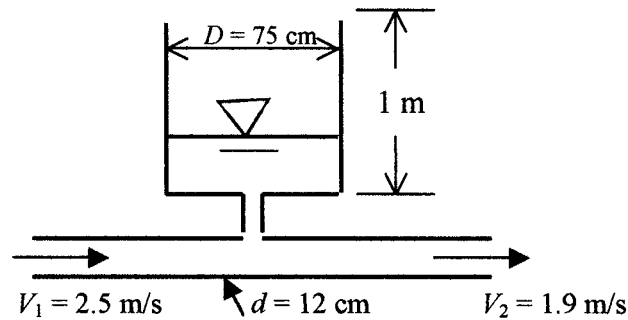


Fig. P3.12

**Solution:** For a control volume enclosing the tank and the portion of the pipe below the tank,

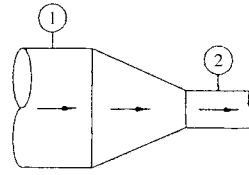
$$\frac{d}{dt} \left[ \int \rho \, dv \right] + \dot{m}_{\text{out}} - \dot{m}_{\text{in}} = 0$$

$$\rho \pi R^2 \frac{dh}{dt} + (\rho AV)_{\text{out}} - (\rho AV)_{\text{in}} = 0$$

$$\frac{dh}{dt} = \frac{4}{998(\pi)(0.75^2)} \left[ 998 \left( \frac{\pi}{4} \right) (0.12^2) (2.5 - 1.9) \right] = 0.0153 \text{ m/s},$$

$$\Delta t = 0.7/0.0153 = \mathbf{46 \text{ s}} \quad \text{Ans.}$$

**3.13** Water at 20°C flows steadily at 40 kg/s through the nozzle in Fig. P3.13. If  $D_1 = 18$  cm and  $D_2 = 5$  cm, compute the average velocity, in m/s, at (a) section 1 and (b) section 2.



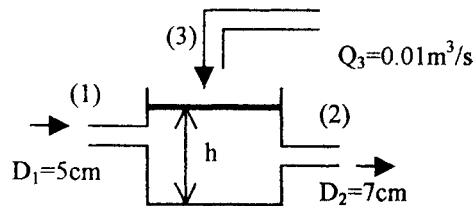
**Fig. P3.13**

**Solution:** The flow is incompressible, hence the volume flow  $Q = (40 \text{ kg/s})/(998 \text{ kg/m}^3) = 0.0401 \text{ m}^3/\text{s}$ . The average velocities are computed from  $Q$  and the two diameters:

$$V_1 = \frac{Q}{A_1} = \frac{0.0401}{(\pi/4)(0.18)^2} = \mathbf{1.58 \text{ m/s}} \quad \text{Ans. (a)}$$

$$V_2 = \frac{Q}{A_2} = \frac{0.0401}{(\pi/4)(0.05)^2} = \mathbf{20.4 \text{ m/s}} \quad \text{Ans. (b)}$$

**3.14** The open tank in the figure contains water at 20°C. For incompressible flow, (a) derive an analytic expression for  $dh/dt$  in terms of  $(Q_1, Q_2, Q_3)$ . (b) If  $h$  is constant, determine  $V_2$  for the given data if  $V_1 = 3$  m/s and  $Q_3 = 0.01 \text{ m}^3/\text{s}$ .



**Solution:** For a control volume enclosing the tank,

$$\frac{d}{dt} \left( \int_{CV} \rho \, dv \right) + \rho(Q_2 - Q_1 - Q_3) = \rho \frac{\pi d^2}{4} \frac{dh}{dt} + \rho(Q_2 - Q_1 - Q_3),$$

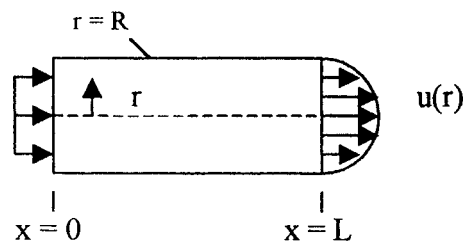
$$\text{solve } \frac{dh}{dt} = \frac{Q_1 + Q_3 - Q_2}{(\pi d^2/4)} \quad \text{Ans. (a)}$$

If  $h$  is constant, then

$$Q_2 = Q_1 + Q_3 = 0.01 + \frac{\pi}{4} (0.05)^2 (3.0) = 0.0159 = \frac{\pi}{4} (0.07)^2 V_2,$$

$$\text{solve } V_2 = \mathbf{4.13 \text{ m/s}} \quad \text{Ans. (b)}$$

**3.15** Water flows steadily through the round pipe in the figure. The entrance velocity is  $V_o$ . The exit velocity approximates turbulent flow,  $u = u_{\max}(1 - r/R)^{1/7}$ . Determine the ratio  $U_o/u_{\max}$  for this incompressible flow.



**Solution:** Inlet and outlet flow must balance:

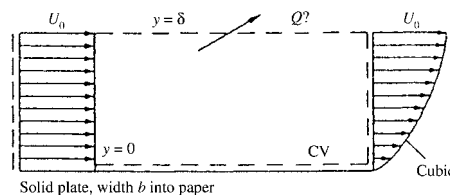
$$Q_1 = Q_2, \quad \text{or:} \quad \int_0^R U_o 2\pi r \, dr = \int_0^R u_{\max} \left(1 - \frac{r}{R}\right)^{1/7} 2\pi r \, dr, \quad \text{or:} \quad U_o \pi R^2 = u_{\max} \frac{49\pi}{60} R^2$$

Cancel and rearrange for this assumed incompressible pipe flow:

$$\frac{U_o}{u_{\max}} = \frac{49}{60} \quad \text{Ans.}$$

**3.16** An incompressible fluid flows past an impermeable flat plate, as in Fig. P3.16, with a uniform inlet profile  $u = U_o$  and a cubic polynomial exit profile

$$u \approx U_o \left( \frac{3\eta - \eta^3}{2} \right) \quad \text{where} \quad \eta = \frac{y}{\delta}$$



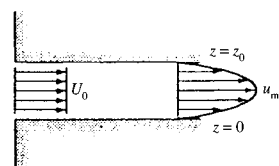
**Fig. P3.16**

Compute the volume flow  $Q$  across the top surface of the control volume.

**Solution:** For the given control volume and incompressible flow, we obtain

$$\begin{aligned} 0 &= Q_{\text{top}} + Q_{\text{right}} - Q_{\text{left}} = Q + \int_0^{\delta} U_o \left( \frac{3y}{2\delta} - \frac{y^3}{2\delta^3} \right) b \, dy - \int_0^{\delta} U_o b \, dy \\ &= Q + \frac{5}{8} U_o b \delta - U_o b \delta, \quad \text{solve for} \quad \mathbf{Q = \frac{3}{8} U_o b \delta} \quad \text{Ans.} \end{aligned}$$

**3.17** Incompressible steady flow in the inlet between parallel plates in Fig. P3.17 is uniform,  $u = U_o = 8$  cm/s, while downstream the flow develops into the parabolic laminar profile  $u = az(z_o - z)$ , where  $a$  is a constant. If  $z_o = 4$  cm and the fluid is SAE 30 oil at  $20^\circ\text{C}$ , what is the value of  $u_{\max}$  in cm/s?



**Fig. P3.17**

**Solution:** Let  $b$  be the plate width into the paper. Let the control volume enclose the inlet and outlet. The walls are solid, so no flow through the wall. For incompressible flow,

$$0 = Q_{\text{out}} - Q_{\text{in}} = \int_0^{z_0} az(z_0 - z)b \, dz - \int_0^{z_0} U_0 b \, dz = abz_0^3/6 - U_0 bz_0 = 0, \quad \text{or: } a = 6U_0/z_0^2$$

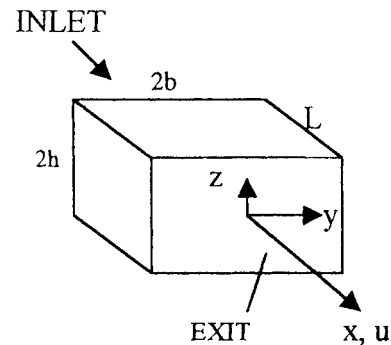
Thus continuity forces the constant  $a$  to have a particular value. Meanwhile,  $a$  is also related to the maximum velocity, which occurs at the center of the parabolic profile:

$$\text{At } z = z_0/2: \quad u = u_{\text{max}} = a \left( \frac{z_0}{2} \right) \left( z_0 - \frac{z_0}{2} \right) = az_0^2/4 = (6U_0/z_0^2)(z_0^2/4)$$

$$\text{or: } u_{\text{max}} = \frac{3}{2}U_0 = \frac{3}{2}(8 \text{ cm/s}) = \mathbf{12 \frac{\text{cm}}{\text{s}}} \quad \text{Ans.}$$

Note that the result is independent of  $z_0$  or of the particular fluid, which is SAE 30 oil.

**3.18** An incompressible fluid flows steadily through the rectangular duct in the figure. The exit velocity profile is given by  $u \approx u_{\text{max}}(1 - y^2/b^2)(1 - z^2/h^2)$ . (a) Does this profile satisfy the correct boundary conditions for viscous fluid flow? (b) Find an analytical expression for the volume flow  $Q$  at the exit. (c) If the inlet flow is 300 ft<sup>3</sup>/min, estimate  $u_{\text{max}}$  in m/s.



**Solution:** (a) The fluid should not slip at any of the duct surfaces, which are defined by  $y = \pm b$  and  $z = \pm h$ . From our formula, we see  $\mathbf{u} \equiv \mathbf{0}$  at all duct surfaces, OK. *Ans.* (a)

(b) The exit volume flow  $Q$  is defined by the integral of  $u$  over the exit plane area:

$$Q = \iint u \, dA = \int_{-h}^{+h} \int_{-b}^{+b} u_{\text{max}} \left( 1 - \frac{y^2}{b^2} \right) \left( 1 - \frac{z^2}{h^2} \right) dy \, dz = u_{\text{max}} \left( \frac{4b}{3} \right) \left( \frac{4h}{3} \right)$$

$$= \frac{\mathbf{16bh}u_{\text{max}}}{9} \quad \text{Ans. (b)}$$

(c) Given  $Q = 300 \text{ ft}^3/\text{min} = 0.1416 \text{ m}^3/\text{s}$ , we need duct dimensions, also (sorry). Let us take  $b = h = 10 \text{ cm}$ . Then the maximum exit velocity is

$$Q = 0.1416 \frac{\text{m}^3}{\text{s}} = \frac{16}{9}(0.1 \text{ m})(0.1 \text{ m})u_{\text{max}}, \quad \text{solve for } \mathbf{u_{\text{max}} = 7.96 \text{ m/s}} \quad \text{Ans. (c)}$$

**3.19** Water from a storm drain flows over an outfall onto a porous bed which absorbs the water at a uniform vertical velocity of 8 mm/s, as shown in Fig. P3.19. The system is 5 m deep into the paper. Find the length  $L$  of bed which will completely absorb the storm water.

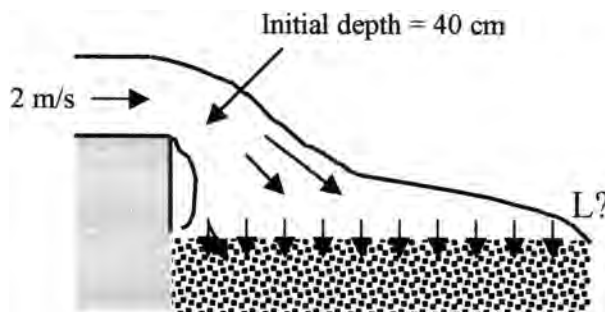


Fig. P3.19

**Solution:** For the bed to completely absorb the water, the flow rate over the outfall must equal that into the porous bed,

$$Q_1 = Q_{PB}; \quad \text{or} \quad (2 \text{ m/s})(0.2 \text{ m})(5 \text{ m}) = (0.008 \text{ m/s})(5 \text{ m})L \quad L \approx 50 \text{ m} \quad \text{Ans.}$$

**3.20** Oil (SG-0.91) enters the thrust bearing at 250 N/hr and exits radially through the narrow clearance between thrust plates. Compute (a) the outlet volume flow in mL/s, and (b) the average outlet velocity in cm/s.

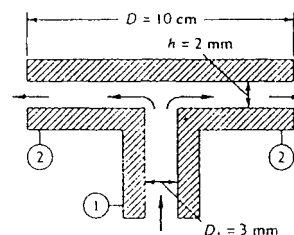


Fig. P3.20

**Solution:** The specific weight of the oil is  $(0.91)(9790) = 8909 \text{ N/m}^3$ . Then

$$Q_2 = Q_1 = \frac{250/3600 \text{ N/s}}{8909 \text{ N/m}^3} = 7.8 \times 10^{-6} \frac{\text{m}^3}{\text{s}} = 7.8 \frac{\text{mL}}{\text{s}} \quad \text{Ans. (a)}$$

$$\text{But also} \quad Q_2 = V_2 \pi (0.1 \text{ m})(0.002 \text{ m}) = 7.8 \times 10^{-6}, \quad \text{solve for} \quad V_2 = 1.24 \frac{\text{cm}}{\text{s}} \quad \text{Ans. (b)}$$

**3.21** A dehumidifier brings in saturated wet air (100 percent relative humidity) at 30°C and 1 atm, through an inlet of 8-cm diameter and average velocity 3 m/s. After some of the water vapor condenses and is drained off at the bottom, the somewhat drier air leaves at approximately 30°C, 1 atm, and 50 percent relative humidity. For steady operation, estimate the amount of water drained off in kg/h. (This problem is idealized from a real dehumidifier.)

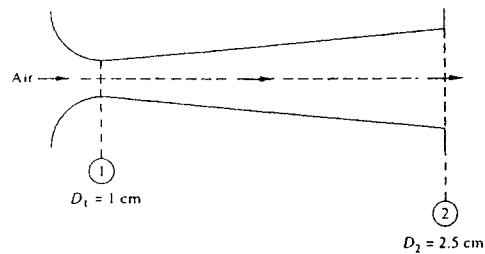
**Solution:** Recall that “relative humidity” is the ratio of water-vapor density *present* in the air to the *saturated* vapor density at the same temperature. From Tables A-4 and A-5 for water at 30°C,  $R_{\text{gas}} = 461 \text{ J}/(\text{kg} \cdot ^\circ\text{K})$  and  $p_{\text{vap}} = 4242 \text{ Pa}$ . Then, at 100% humidity,

$$\rho_{\text{vapor}} = \frac{p_{\text{vap}}}{RT} = \frac{4242}{(461)(303)} = 0.0304 \text{ kg/m}^3$$

Meanwhile, the inlet volume flow of wet air is  $Q_{\text{in}} = AV = (\pi/4)(0.08 \text{ m})^2(3 \text{ m/s}) = 0.0151 \text{ m}^3/\text{s}$ . It follows that the mass of water vapor entering is  $\rho_{\text{vap}}Q_{\text{in}} = 4.58\text{E-}4 \text{ kg/s}$ . If the air leaves at 50% relative humidity, exactly half of this is drained away:

$$\dot{m}_{\text{drained away}} = (1/2)(4.58\text{E-}4)(3600) \approx \mathbf{0.82 \frac{\text{kg}}{\text{hr}}} \quad \text{Ans.}$$

**3.22** The converging-diverging nozzle shown in Fig. P3.22 expands and accelerates dry air to supersonic speeds at the exit, where  $p_2 = 8 \text{ kPa}$  and  $T_2 = 240 \text{ K}$ . At the throat,  $p_1 = 284 \text{ kPa}$ ,  $T_1 = 665 \text{ K}$ , and  $V_1 = 517 \text{ m/s}$ . For steady compressible flow of an ideal gas, estimate (a) the mass flow in kg/h, (b) the velocity  $V_2$ , and (c) the Mach number  $\text{Ma}_2$ .



**Fig. P3.22**

**Solution:** The mass flow is given by the throat conditions:

$$\dot{m} = \rho_1 A_1 V_1 = \left[ \frac{284000}{(287)(665)} \frac{\text{kg}}{\text{m}^3} \right] \frac{\pi}{4} (0.01 \text{ m})^2 \left( 517 \frac{\text{m}}{\text{s}} \right) = \mathbf{0.0604 \frac{\text{kg}}{\text{s}}} \quad \text{Ans. (a)}$$

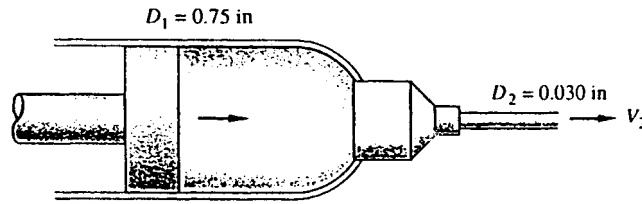
For steady flow, this must equal the mass flow at the exit:

$$0.0604 \frac{\text{kg}}{\text{s}} = \rho_2 A_2 V_2 = \left[ \frac{8000}{287(240)} \right] \frac{\pi}{4} (0.025)^2 V_2, \quad \text{or} \quad V_2 \approx \mathbf{1060 \frac{\text{m}}{\text{s}}} \quad \text{Ans. (b)}$$

Recall from Eq. (1.39) that the speed of sound of an ideal gas  $= (kRT)^{1/2}$ . Then

$$\text{Mach number at exit: } \text{Ma} = V_2/a_2 = \frac{1060}{[1.4(287)(240)]^{1/2}} \approx \mathbf{3.41} \quad \text{Ans. (c)}$$

**3.23** The hypodermic needle in the figure contains a liquid (SG = 1.05). If the serum is to be injected steadily at  $6 \text{ cm}^3/\text{s}$ , how fast should the plunger be advanced (a) if leakage in the plunger clearance is neglected; and (b) if leakage is 10 percent of the needle flow?



**Solution:** (a) For incompressible flow, the volume flow is the same at piston and exit:

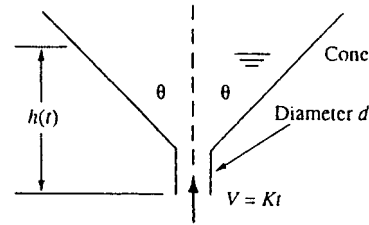
$$Q = 6 \frac{\text{cm}^3}{\text{s}} = 0.366 \frac{\text{in}^3}{\text{s}} = A_1 V_1 = \frac{\pi}{4} (0.75 \text{ in})^2 V_1, \quad \text{solve } V_{\text{piston}} = \mathbf{0.83 \frac{\text{in}}{\text{s}}} \quad \text{Ans. (a)}$$

(b) If there is 10% leakage, the piston must deliver both needle flow and leakage:

$$A_1 V_1 = Q_{\text{needle}} + Q_{\text{clearance}} = 6 + 0.1(6) = 6.6 \frac{\text{cm}^3}{\text{s}} = 0.403 \frac{\text{in}^3}{\text{s}} = \frac{\pi}{4} (0.75)^2 V_1,$$

$$V_1 = \mathbf{0.91 \frac{\text{in}}{\text{s}}} \quad \text{Ans. (b)}$$

**3.24** Water enters the bottom of the cone in the figure at a uniformly increasing average velocity  $V = Kt$ . If  $d$  is very small, derive an analytic formula for the water surface rise  $h(t)$ , assuming  $h = 0$  at  $t = 0$ .



**Solution:** For a control volume around the cone, the mass relation becomes

$$\frac{d}{dt} \left( \int \rho dv \right) - \dot{m}_{\text{in}} = 0 = \frac{d}{dt} \left[ \rho \frac{\pi}{3} (h \tan \theta)^2 h \right] - \rho \frac{\pi}{4} d^2 Kt$$

$$\text{Integrate: } \rho \frac{\pi}{3} h^3 \tan^2 \theta = \rho \frac{\pi}{8} d^2 Kt^2$$

$$\text{Solve for } \mathbf{h(t) = \left[ \frac{3}{8} Kt^2 d^2 \cot^2 \theta \right]^{1/3}} \quad \text{Ans.}$$

**3.25** As will be discussed in Chaps. 7 and 8, the flow of a stream  $U_o$  past a blunt flat plate creates a broad low-velocity wake behind the plate. A simple model is given in Fig. P3.25, with only half of the flow shown due to symmetry. The velocity profile behind the plate is idealized as “dead air” (near-zero velocity) behind the plate, plus a higher

velocity, decaying vertically above the wake according to the variation  $u \approx U_0 + \Delta U e^{-z/L}$ , where  $L$  is the plate height and  $z = 0$  is the top of the wake. Find  $\Delta U$  as a function of stream speed  $U_0$ .

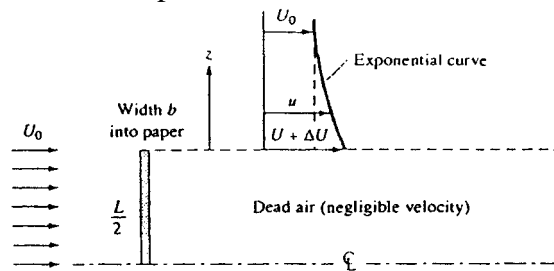


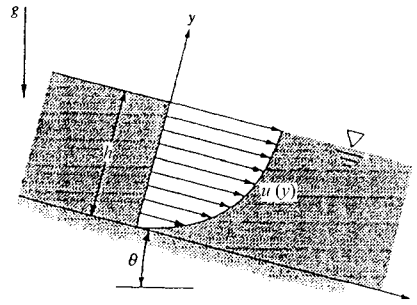
Fig. P3.25

**Solution:** For a control volume enclosing the upper half of the plate and the section where the exponential profile applies, extending upward to a large distance  $H$  such that  $\exp(-H/L) \approx 0$ , we must have inlet and outlet volume flows the same:

$$Q_{\text{in}} = \int_{-L/2}^H U_0 dz = Q_{\text{out}} = \int_0^H (U_0 + \Delta U e^{-z/L}) dz, \quad \text{or: } U_0 \left( H + \frac{L}{2} \right) = U_0 H + \Delta U L$$

$$\text{Cancel } U_0 H \text{ and solve for } \Delta U \approx \frac{1}{2} U_0 \quad \text{Ans.}$$

**3.26** A thin layer of liquid, draining from an inclined plane, as in the figure, will have a laminar velocity profile  $u = U_0(2y/h - y^2/h^2)$ , where  $U_0$  is the surface velocity. If the plane has width  $b$  into the paper, (a) determine the volume rate of flow of the film. (b) Suppose that  $h = 0.5$  in and the flow rate per foot of channel width is 1.25 gal/min. Estimate  $U_0$  in ft/s.



**Solution:** (a) The total volume flow is computed by integration over the flow area:

$$Q = \int V_n dA = \int_0^h U_0 \left( \frac{2y}{h} - \frac{y^2}{h^2} \right) b dy = \frac{2}{3} U_0 b h \quad \text{Ans. (a)}$$

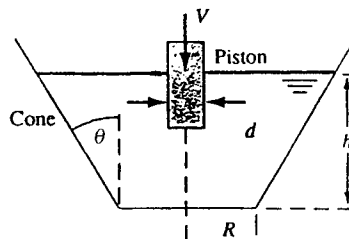
(b) Evaluate the above expression for the given data:

$$Q = 1.25 \frac{\text{gal}}{\text{min}} = 0.002785 \frac{\text{ft}^3}{\text{s}} = \frac{2}{3} U_0 b h = \frac{2}{3} U_0 (1.0 \text{ ft}) \left( \frac{0.5}{12} \text{ ft} \right),$$

$$\text{solve for } U_0 = 0.10 \frac{\text{ft}}{\text{s}} \quad \text{Ans. (b)}$$



**3.27** The cone frustum in the figure contains incompressible liquid to depth  $h$ . A solid piston of diameter  $d$  penetrates the surface at velocity  $V$ . Derive an analytic expression for the rate of rise  $dh/dt$  of the liquid surface.



**Solution:** The piston motion is equivalent to a volume flow  $Q_{in} = VA_{piston}$  into the liquid. A control volume around the frustum tank yields

$$\frac{d}{dt} \left( \int \rho dv \right) - \dot{m}_{in} = 0 = \rho \frac{d}{dt} \left\{ \frac{\pi}{3} [(R + h \tan \theta)^2 (h + R \cot \theta) - R^2 (R \cot \theta)] \right\} - \rho V \frac{\pi}{4} d^2$$

$$\text{Cancel } \rho \text{ and } \pi: \frac{d}{dt} (3R^2 h + 3Rh^2 \tan \theta + h^3 \tan^2 \theta) = \frac{3}{4} V d^2$$

$$\text{Differentiate and rearrange: } \frac{dh}{dt} = \frac{V d^2}{4R^2 + 8Rh \tan \theta + 4h^2 \tan^2 \theta} \quad \text{Ans.}$$

**3.28** According to Torricelli's theorem, the velocity of a fluid draining from a hole in a tank is  $V \approx (2gh)^{1/2}$ , where  $h$  is the depth of water above the hole, as in Fig. P3.28. Let the hole have area  $A_o$  and the cylindrical tank have bottom area  $A_b$ . Derive a formula for the time to drain the tank from an initial depth  $h_o$ .

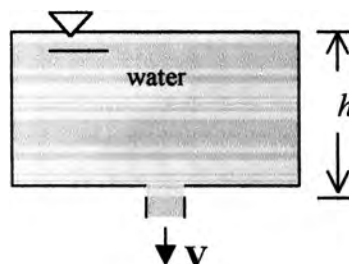


Fig. P3.28

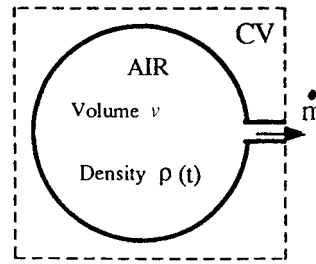
**Solution:** For a control volume around the tank,

$$\frac{d}{dt} \left[ \int \rho dv \right] + \dot{m}_{out} = 0$$

$$\rho A_b \frac{dh}{dt} = -\dot{m}_{out} = -\rho A_o \sqrt{2gh}$$

$$\int_{h_o}^0 \frac{dh}{\sqrt{h}} = \int_0^t \frac{A_o \sqrt{2g}}{A_b} dt; \quad t = \frac{A_b}{A_o} \sqrt{\frac{h_o}{2g}} \quad \text{Ans.}$$

**3.29** In elementary compressible-flow theory (Chap. 9), compressed air will exhaust from a small hole in a tank at the mass flow rate  $\dot{m} \approx C\rho$ , where  $\rho$  is the air density in the tank and  $C$  is a constant. If  $\rho_0$  is the initial density in a tank of volume  $v$ , derive a formula for the density change  $\rho(t)$  after the hole is opened. Apply your formula to the following case: a spherical tank of diameter 50 cm, with initial pressure 300 kPa and temperature 100°C, and a hole whose initial exhaust rate is 0.01 kg/s. Find the time required for the tank density to drop by 50 percent.



**Solution:** For a control volume enclosing the tank and the exit jet, we obtain

$$0 = \frac{d}{dt} \left( \int \rho dv \right) + \dot{m}_{\text{out}}, \quad \text{or:} \quad v \frac{d\rho}{dt} = -\dot{m}_{\text{out}} = -C\rho,$$

$$\text{or:} \quad \int_{\rho_0}^{\rho} \frac{d\rho}{\rho} = -\frac{C}{v} \int_0^t dt, \quad \text{or:} \quad \frac{\rho}{\rho_0} \approx \exp \left[ -\frac{C}{v} t \right] \quad \text{Ans.}$$

Now apply this formula to the given data. If  $p_0 = 300$  kPa and  $T_0 = 100^\circ\text{C} = 373^\circ\text{K}$ , then  $\rho_0 = p/RT = (300,000)/[287(373)] \approx 2.80$  kg/m<sup>3</sup>. This establishes the constant “C”:

$$\dot{m}_0 = C\rho_0 = 0.01 \frac{\text{kg}}{\text{s}} = C \left( 2.80 \frac{\text{kg}}{\text{m}^3} \right), \quad \text{or} \quad C \approx 0.00357 \frac{\text{m}^3}{\text{s}} \quad \text{for this hole.}$$

The tank volume is  $v = (\pi/6)D^3 = (\pi/6)(0.5 \text{ m})^3 \approx 0.00654 \text{ m}^3$ . Then we require

$$\rho/\rho_0 = 0.5 = \exp \left[ -\frac{0.00357}{0.00654} t \right] \quad \text{if } t \approx 1.3 \text{ s} \quad \text{Ans.}$$

**3.30** A wedge splits a sheet of 20°C water, as shown in Fig. P3.30. Both wedge and sheet are very long into the paper. If the force required to hold the wedge stationary is  $F = 124$  N per meter of depth into the paper, what is the angle  $\theta$  of the wedge?

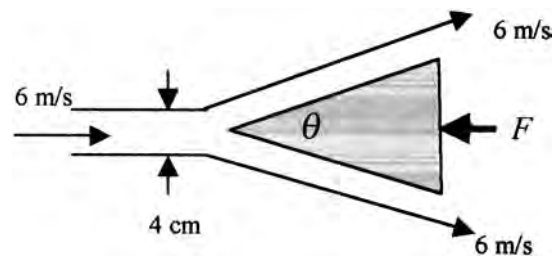


Fig. P3.30

**Solution:** Since the wedge is very deep, assume uniform flow (neglect end effects) and apply momentum,

$$\sum F_x = -F = -\dot{m}_{in} u_{in} \quad \text{Where } \dot{m}_{in} = (\rho AV) = (998)(0.04 \times 1)(6) = 239.5 \text{ kg/s}$$

$$(124 \text{ N/m})(1 \text{ m}) = (239.5)(6) \left( \cos \left[ \frac{\theta}{2} \right] - 1 \right)$$

$$\theta = 48^\circ \quad \text{Ans.}$$

**3.31** A bellows may be modeled as a deforming wedge-shaped volume as in Fig. P3.31. The check valve on the left (pleated) end is closed during the stroke. If  $b$  is the bellows width into the paper, derive an expression for outlet mass flow  $\dot{m}_o$  as a function of stroke  $\theta(t)$ .

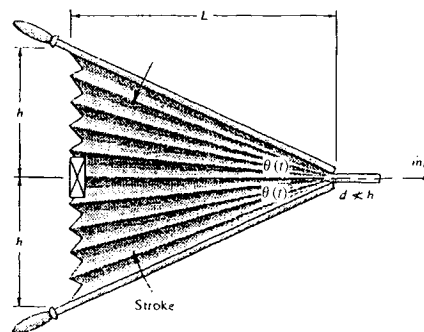


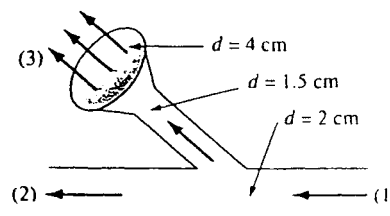
Fig. P3.31

**Solution:** For a control volume enclosing the bellows and the outlet flow, we obtain

$$\frac{d}{dt}(\rho v) + \dot{m}_{out} = 0, \quad \text{where } v = bhL = bL^2 \tan \theta$$

$$\text{since } L \text{ is constant, solve for } \dot{m}_o = -\frac{d}{dt}(\rho bL^2 \tan \theta) = -\rho bL^2 \sec^2 \theta \frac{d\theta}{dt} \quad \text{Ans.}$$

**3.32** Water at 20°C flows through the piping junction in the figure, entering section 1 at 20 gal/min. The average velocity at section 2 is 2.5 m/s. A portion of the flow is diverted through the showerhead, which contains 100 holes of 1-mm diameter. Assuming uniform shower flow, estimate the exit velocity from the showerhead jets.



**Solution:** A control volume around sections (1, 2, 3) yields

$$Q_1 = Q_2 + Q_3 = 20 \text{ gal/min} = 0.001262 \text{ m}^3/\text{s}.$$

Meanwhile, with  $V_2 = 2.5 \text{ m/s}$  known, we can calculate  $Q_2$  and then  $Q_3$ :

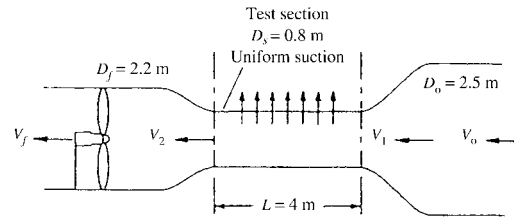
$$Q_2 = V_2 A_2 = (2.5 \text{ m}) \frac{\pi}{4} (0.02 \text{ m})^2 = 0.000785 \frac{\text{m}^3}{\text{s}},$$

$$\text{hence } Q_3 = Q_1 - Q_2 = 0.001262 - 0.000785 = 0.000476 \frac{\text{m}^3}{\text{s}}$$

$$\text{Each hole carries } Q_3/100 = 0.0000476 \frac{\text{m}^3}{\text{s}} = \frac{\pi}{4} (0.001)^2 V_{jet},$$

$$\text{solve } V_{jet} = \mathbf{6.06} \frac{\text{m}}{\text{s}} \quad \text{Ans.}$$

**3.33** In some wind tunnels the test section is perforated to suck out fluid and provide a thin viscous boundary layer. The test section wall in Fig. P3.33 contains 1200 holes of 5-mm diameter each per square meter of wall area. The suction velocity through each hole is  $V_r = 8$  m/s, and the test-section entrance velocity is  $V_1 = 35$  m/s. Assuming incompressible steady flow of air at 20°C, compute (a)  $V_o$ , (b)  $V_2$ , and (c)  $V_f$  in m/s.



**Fig. P3.33**

**Solution:** The test section wall area is  $(\pi)(0.8 \text{ m})(4 \text{ m}) = 10.053 \text{ m}^2$ , hence the total number of holes is  $(1200)(10.053) = 12064$  holes. The total suction flow leaving is

$$Q_{\text{suction}} = NQ_{\text{hole}} = (12064)(\pi/4)(0.005 \text{ m})^2(8 \text{ m/s}) \approx 1.895 \text{ m}^3/\text{s}$$

$$\text{(a) Find } V_o: Q_o = Q_1 \quad \text{or} \quad V_o \frac{\pi}{4} (2.5)^2 = (35) \frac{\pi}{4} (0.8)^2,$$

$$\text{solve for } V_o \approx \mathbf{3.58} \frac{\text{m}}{\text{s}} \quad \text{Ans. (a)}$$

$$\text{(b) } Q_2 = Q_1 - Q_{\text{suction}} = (35) \frac{\pi}{4} (0.8)^2 - 1.895 = V_2 \frac{\pi}{4} (0.8)^2,$$

$$\text{or: } V_2 \approx \mathbf{31.2} \frac{\text{m}}{\text{s}} \quad \text{Ans. (b)}$$

$$\text{(c) Find } V_f: Q_f = Q_2 \quad \text{or} \quad V_f \frac{\pi}{4} (2.2)^2 = (31.2) \frac{\pi}{4} (0.8)^2,$$

$$\text{solve for } V_f \approx \mathbf{4.13} \frac{\text{m}}{\text{s}} \quad \text{Ans. (c)}$$

**3.34** A rocket motor is operating steadily, as shown in Fig. P3.34. The products of combustion flowing out the exhaust nozzle approximate a perfect gas with a molecular weight of 28. For the given conditions calculate  $V_2$  in ft/s.

**Solution:** Exit gas: Molecular weight = 28, thus  $R_{\text{gas}} = 49700/28 = 1775 \text{ ft}^2/(\text{s}^2 \cdot ^\circ\text{R})$ . Then,

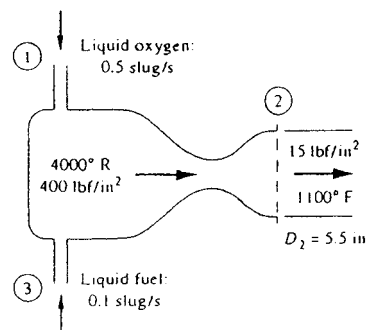


Fig. P3.34

$$\rho_{\text{exit gas}} = \frac{p}{RT} = \frac{15(144) \text{ psf}}{(1775)(1100 + 460)} \approx 0.000780 \text{ slug/ft}^2$$

For mass conservation, the exit mass flow must equal fuel + oxygen entering = 0.6 slug/s:

$$\dot{m}_{\text{exit}} = 0.6 \frac{\text{slug}}{\text{s}} = \rho_e A_e V_e = (0.00078) \frac{\pi}{4} \left( \frac{5.5}{12} \right)^2 V_e, \quad \text{solve for } V_e \approx 4660 \frac{\text{ft}}{\text{s}} \quad \text{Ans.}$$

**3.35** In contrast to the liquid rocket in Fig. P3.34, the solid-propellant rocket in Fig. P3.35 is self-contained and has no entrance ducts. Using a control-volume analysis for the conditions shown in Fig. P3.35, compute the rate of mass loss of the propellant, assuming that the exit gas has a molecular weight of 28.

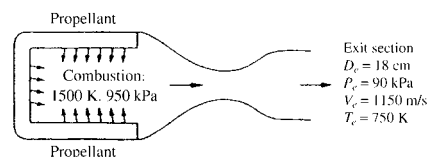


Fig. P3.35

**Solution:** With  $M = 28$ ,  $R = 8313/28 = 297 \text{ m}^2/(\text{s}^2 \cdot \text{K})$ , hence the exit gas density is

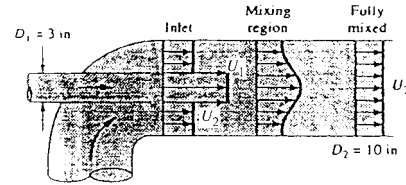
$$\rho_{\text{exit}} = \frac{p}{RT} = \frac{90,000 \text{ Pa}}{(297)(750 \text{ K})} = 0.404 \text{ kg/m}^3$$

For a control volume enclosing the rocket engine and the outlet flow, we obtain

$$\frac{d}{dt}(m_{\text{CV}}) + \dot{m}_{\text{out}} = 0,$$

$$\text{or: } \frac{d}{dt}(m_{\text{propellant}}) = -\dot{m}_{\text{exit}} = -\rho_e A_e V_e = -(0.404)(\pi/4)(0.18)^2 (1150) \approx -11.8 \frac{\text{kg}}{\text{s}} \quad \text{Ans.}$$

**3.36** The jet pump in Fig. P3.36 injects water at  $U_1 = 40$  m/s through a 3-in pipe and entrains a secondary flow of water  $U_2 = 3$  m/s in the annular region around the small pipe. The two flows become fully mixed downstream, where  $U_3$  is approximately constant. For steady incompressible flow, compute  $U_3$  in m/s.

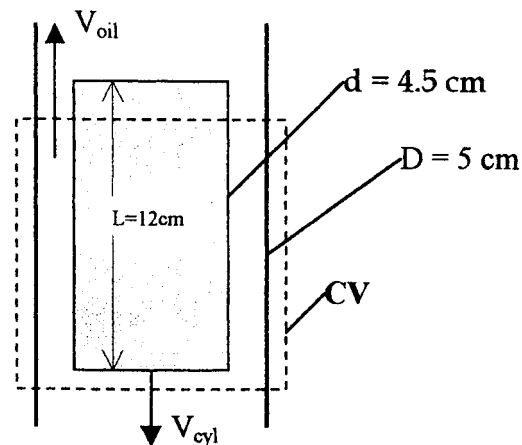


**Solution:** First modify the units:  $D_1 = 3$  in = 0.0762 m,  $D_2 = 10$  in = 0.254 m. For incompressible flow, the volume flows at inlet and exit must match:

$$Q_1 + Q_2 = Q_3, \quad \text{or:} \quad \frac{\pi}{4}(0.0762)^2(40) + \frac{\pi}{4}[(0.254)^2 - (0.0762)^2](3) = \frac{\pi}{4}(0.254)^2 U_3$$

$$\text{Solve for } U_3 \approx 6.33 \text{ m/s} \quad \text{Ans.}$$

**3.37** A solid steel cylinder, 4.5 cm in diameter and 12 cm long, with a mass of 1500 grams, falls concentrically through a 5-cm-diameter vertical container filled with oil (SG = 0.89). Assuming the oil is incompressible, estimate the oil average velocity in the annular clearance between cylinder and container (a) relative to the container; and (b) relative to the cylinder.



**Solution:** (a) The *fixed* CV shown is relative to the *container*, thus:

$$Q_{cyl} = Q_{oil}, \quad \text{or:} \quad \frac{\pi}{4}d^2V_{cyl} = \frac{\pi}{4}(D^2 - d^2)V_{oil}, \quad \text{thus} \quad V_{oil} = \frac{d^2}{D^2 - d^2}V_{cyl} \quad \text{Ans. (a)}$$

For the given dimensions ( $d = 4.5$  cm and  $D = 5.0$  cm),  $V_{oil} = 4.26 V_{cylinder}$ .

(b) If the CV moves *with* the cylinder we obtain, relative to the cylinder,

$$V_{oil \text{ relative to cylinder}} = V_{part(a)} + V_{cyl} = \frac{D^2}{D^2 - d^2}V_{cyl} \approx 5.26V_{cyl} \quad \text{Ans. (b)}$$

**3.38** An incompressible fluid is squeezed between two disks by downward motion  $V_o$  of the upper disk. Assuming 1-dimensional radial outflow, find the velocity  $V(r)$ .

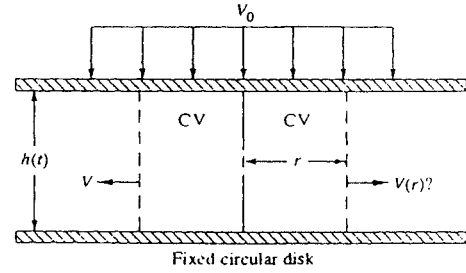


Fig. P3.38

**Solution:** Let the CV enclose the disks and have an upper surface moving down at speed  $V_o$ . There is no inflow. Thus

$$\frac{d}{dt} \left( \int_{CV} \rho \, dv \right) + \int_{CS} \rho V_{out} \, dA = 0 = \frac{d}{dt} (\rho \pi r^2 h) + \rho 2\pi r h V,$$

or:  $r^2 \frac{dh}{dt} + 2rhV = 0$ , but  $\frac{dh}{dt} = -V_o$  (the disk velocity)

As the disk spacing drops,  $h(t) \approx h_o - V_o t$ , the outlet velocity is  $V = V_o r / (2h)$ . *Ans.*

**3.39** For the elbow duct in Fig. P3.39, SAE 30 oil at 20°C enters section 1 at 350 N/s, where the flow is laminar, and exits at section 2, where the flow is turbulent:

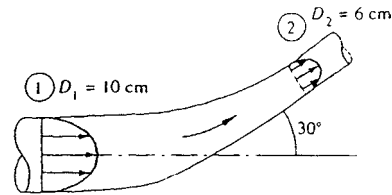


Fig. P3.39

$$u_1 \approx V_{av,1} \left( 1 - \frac{r^2}{R_1^2} \right) \quad u_2 \approx V_{av,2} \left( 1 - \frac{r}{R_2} \right)^{1/7}$$

Assuming steady incompressible flow, compute the force, and its direction, of the oil on the elbow due to momentum change only (no pressure change or friction effects) for (a) unit momentum-flux correction factors and (b) actual correction factors  $\beta_1$  and  $\beta_2$ .

**Solution:** For SAE 30 oil,  $\gamma = 8720 \text{ N/m}^3$ , thus  $Q = 350/8720 = 0.0401 \text{ m}^3/\text{s}$ . This flow  $Q$  must equal the integrated volume flow through each section:

$$Q = 0.0401 = \pi(0.05)^2 V_{av,1} = \pi(0.03)^2 V_{av,2}, \quad \text{or} \quad V_{ax,1} = 5.11 \frac{\text{m}}{\text{s}}, \quad V_{av,2} = 14.2 \frac{\text{m}}{\text{s}}$$

Now apply the linear momentum relation to a CV enclosing the inlet and outlet, noting from Eqs. (3.43), p. 136, that  $\beta_1 \approx 1.333$  (laminar) and  $\beta_2 \approx 1.020$  (turbulent):

$$F_x = \beta_2 \rho A_2 V_{av,2}^2 \cos \theta - \beta_1 \rho A_1 V_{av,1}^2; \quad F_y = \beta_2 \rho A_2 V_{av,2}^2 \sin \theta$$

(a) If we neglect the momentum-flux correction factors,  $\beta \approx 1.0$ , we obtain

$$F_x = (890)\pi(0.03)^2(14.2)^2 \cos 30^\circ - (890)\pi(0.05)^2(5.11)^2 = 439 - 183 \approx \mathbf{256 \text{ N}} \quad \text{Ans. (a)}$$

$$F_y = (890)\pi(0.03)^2(14.2)^2 \sin 30^\circ \approx \mathbf{254 \text{ N}} \quad \text{Ans. (a)}$$

Whereas, if we include correction factors  $\beta_1 \approx 1.333$  and  $\beta_2 \approx 1.020$ , we obtain

$$F_x = (1.020)(439) - (1.333)(183) \approx \mathbf{205 \text{ N}}; \quad F_y = (1.020)(254) \approx \mathbf{259 \text{ N}} \quad \text{Ans. (b)}$$

**3.40** The water jet in Fig. P3.40 strikes normal to a fixed plate. Neglect gravity and friction, and compute the force  $F$  in newtons required to hold the plate fixed.

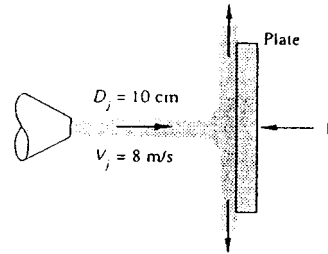


Fig. P3.40

**Solution:** For a CV enclosing the plate and the impinging jet, we obtain:

$$\begin{aligned} \sum F_x &= -F = \dot{m}_{\text{up}} u_{\text{up}} + \dot{m}_{\text{down}} u_{\text{down}} - \dot{m}_j u_j \\ &= -\dot{m}_j u_j, \quad \dot{m}_j = \rho A_j V_j \end{aligned}$$

$$\text{Thus } F = \rho A_j V_j^2 = (998)\pi(0.05)^2(8)^2 \approx \mathbf{500 \text{ N}} \leftarrow \text{Ans.}$$

**3.41** In Fig. P3.41 the vane turns the water jet completely around. Find the maximum jet velocity  $V_o$  for a force  $F_o$ .

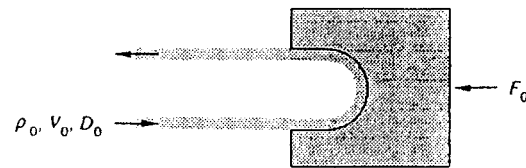


Fig. P3.41

**Solution:** For a CV enclosing the vane and the inlet and outlet jets,

$$\sum F_x = -F_o = \dot{m}_{\text{out}} u_{\text{out}} - \dot{m}_{\text{in}} u_{\text{in}} = \dot{m}_{\text{jet}}(-V_o) - \dot{m}_{\text{jet}}(+V_o)$$

$$\text{or: } F_o = 2\rho_o A_o V_o^2, \quad \text{solve for } V_o = \sqrt{\frac{F_o}{2\rho_o(\pi/4)D_o^2}} \quad \text{Ans.}$$

**3.42** A liquid of density  $\rho$  flows through the sudden contraction in Fig. P3.42 and exits to the atmosphere. Assume uniform conditions  $(p_1, V_1, D_1)$  at section 1 and  $(p_2, V_2, D_2)$  at section 2. Find an expression for the force  $F$  exerted by the fluid on the contraction.

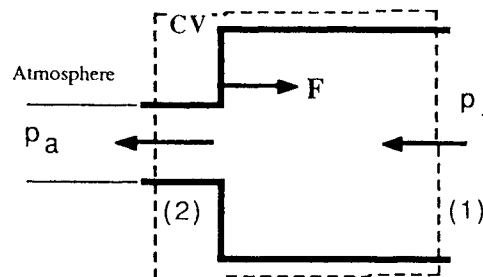


Fig. P3.42



**Solution:** Since the flow exits directly to the atmosphere, the exit pressure equals atmospheric:  $p_2 = p_a$ . Let the CV enclose sections 1 and 2, as shown. Use our trick (page 129 of the text) of subtracting  $p_a$  everywhere, so that the only non-zero pressure on the CS is at section 1,  $p = p_1 - p_a$ . Then write the linear momentum relation with  $x$  to the right:

$$\sum F_x = F - (p_1 - p_a)A_1 = \dot{m}_2 u_2 - \dot{m}_1 u_1, \quad \text{where } \dot{m}_2 = \dot{m}_1 = \rho_1 A_1 V_1$$

$$\text{But } u_2 = -V_2 \quad \text{and} \quad u_1 = -V_1. \quad \text{Solve for } F_{\text{on fluid}} = (p_1 - p_a)A_1 + \rho_1 A_1 V_1 (-V_2 + V_1)$$

Meanwhile, from continuity, we can relate the two velocities:

$$Q_1 = Q_2, \quad \text{or} \quad (\pi/4)D_1^2 V_1 = (\pi/4)D_2^2 V_2, \quad \text{or:} \quad V_2 = V_1 (D_1^2/D_2^2)$$

Finally, the force of the fluid on the wall is equal and opposite to  $F_{\text{on fluid}}$ , to the *left*:

$$F_{\text{fluid on wall}} = (p_1 - p_a)A_1 - \rho_1 A_1 V_1^2 \left[ \left( D_1^2/D_2^2 \right) - 1 \right], \quad A_1 = \frac{\pi}{4} D_1^2 \quad \text{Ans.}$$

The pressure term is larger than the momentum term, thus  $F > 0$  and acts to the left.

**3.43** Water at 20°C flows through a 5-cm-diameter pipe which has a 180° vertical bend, as in Fig. P3.43. The total length of pipe between flanges 1 and 2 is 75 cm. When the weight flow rate is 230 N/s,  $p_1 = 165$  kPa, and  $p_2 = 134$  kPa. Neglecting pipe weight, determine the total force which the flanges must withstand for this flow.

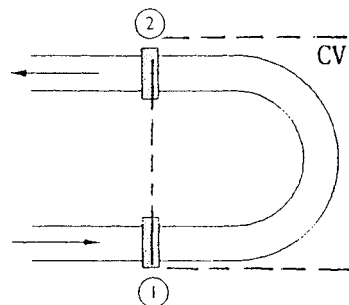


Fig. P3.43

**Solution:** Let the CV cut through the flanges and surround the pipe bend. The mass flow rate is  $(230 \text{ N/s})/(9.81 \text{ m/s}^2) = 23.45 \text{ kg/s}$ . The volume flow rate is  $Q = 230/9790 = 0.0235 \text{ m}^3/\text{s}$ . Then the pipe inlet and exit velocities are the same magnitude:

$$V_1 = V_2 = V = Q/A = \frac{0.0235 \text{ m}^3/\text{s}}{(\pi/4)(0.05 \text{ m})^2} \approx 12.0 \frac{\text{m}}{\text{s}}$$

Subtract  $p_a$  everywhere, so only  $p_1$  and  $p_2$  are non-zero. The horizontal force balance is:

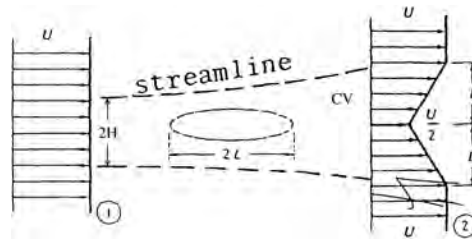
$$\begin{aligned} \sum F_x &= F_{x,\text{flange}} + (p_1 - p_a)A_1 + (p_2 - p_a)A_2 = \dot{m}_2 u_2 - \dot{m}_1 u_1 \\ &= F_{x,\text{fl}} + (64000) \frac{\pi}{4} (0.05)^2 + (33000) \frac{\pi}{4} (0.05)^2 = (23.45)(-12.0 - 12.0 \text{ m/s}) \\ \text{or: } F_{x,\text{flange}} &= -126 - 65 - 561 \approx \mathbf{-750 \text{ N}} \quad \text{Ans.} \end{aligned}$$

The total  $x$ -directed force on the flanges acts to the left. The vertical force balance is

$$\sum F_y = F_{y,\text{flange}} = W_{\text{pipe}} + W_{\text{fluid}} = 0 + (9790) \frac{\pi}{4} (0.05)^2 (0.75) \approx \mathbf{14 \text{ N}} \quad \text{Ans.}$$

Clearly the fluid weight is pretty small. The largest force is due to the  $180^\circ$  turn.

**3.44** Consider uniform flow past a cylinder with a V-shaped *wake*, as shown. Pressures at (1) and (2) are equal. Let  $b$  be the width into the paper. Find a formula for the force  $F$  on the cylinder due to the flow. Also compute  $C_D = F/(\rho U^2 L b)$ .



**Fig. P3.44**

**Solution:** The proper CV is the entrance (1) and exit (2) plus *streamlines* above and below which hit the top and bottom of the wake, as shown. Then steady-flow continuity yields,

$$0 = \int_2 \rho u \, dA - \int_1 \rho u \, dA = 2 \int_0^L \rho \frac{U}{2} \left(1 + \frac{y}{L}\right) b \, dy - 2\rho U b H,$$

where  $2H$  is the inlet height. Solve for  $H = 3L/4$ .

Now the linear momentum relation is used. Note that the drag force  $F$  is to the right (force of the fluid on the body) thus the force  $F$  of the body on fluid is to the left. We obtain,

$$\sum F_x = 0 = \int_2 u \rho u \, dA - \int_1 u \rho u \, dA = 2 \int_0^L \frac{U}{2} \left(1 + \frac{y}{L}\right) \rho \frac{U}{2} \left(1 + \frac{y}{L}\right) b \, dy - 2H \rho U^2 b = -F_{\text{drag}}$$

$$\text{Use } H = \frac{3L}{4}, \text{ then } F_{\text{drag}} = \frac{3}{2} \rho U^2 L b - \frac{7}{6} \rho U^2 L b \approx \frac{1}{3} \rho U^2 L b \quad \text{Ans.}$$

The dimensionless force, or drag coefficient  $F/(\rho U^2 L b)$ , equals  $C_D = 1/3$ . *Ans.*

**3.45** In Fig. P3.45 a perfectly balanced 700-N weight and platform are supported by a steady water jet. What is the proper jet velocity?

**Solution:** For a CV surrounding the weight, platform, and jet, vertical forces yield,

$$\sum F_y = -W = \dot{m}_{\text{left}} V_{\text{left}} + \dot{m}_{\text{right}} V_{\text{right}} - \dot{m}_o V_o = 0 + 0 - (\rho_o A_o V_o) V_o$$

$$\text{Thus } W = 700 \text{ N} = (998) \frac{\pi}{4} (0.05)^2 V_o^2, \text{ solve for } V_o = V_{\text{jet}} = \mathbf{18.9 \frac{m}{s}} \text{ Ans.}$$

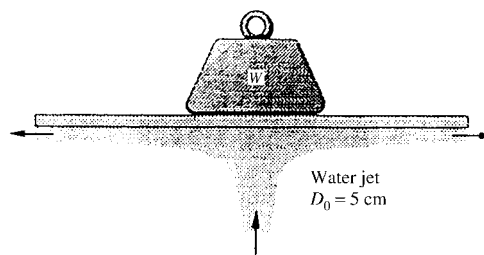


Fig. P3.45

**3.46** When a jet strikes an inclined plate, it breaks into two jets of equal velocity  $V$  but unequal fluxes  $\alpha Q$  at (2) and  $(1 - \alpha)Q$  at (3), as shown. Find  $\alpha$ , assuming that the tangential force on the plate is zero. Why doesn't the result depend upon the properties of the jet flow?

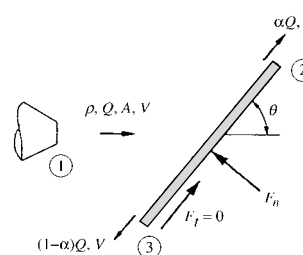


Fig. P3.46

**Solution:** Let the CV enclose all three jets and the surface of the plate. Analyze the force and momentum balance *tangential* to the plate:

$$\begin{aligned} \sum F_t = F_t = 0 &= \dot{m}_2 V + \dot{m}_3 (-V) - \dot{m}_1 V \cos \theta \\ &= \alpha \dot{m} V - (1 - \alpha) \dot{m} V - \dot{m} V \cos \theta = 0, \text{ solve for } \alpha = \frac{1}{2} (1 + \cos \theta) \text{ Ans.} \end{aligned}$$

The jet mass flow cancels out. Jet (3) has a fractional flow  $(1 - \alpha) = (1/2)(1 - \cos \theta)$ .

**3.47** A liquid jet  $V_j$  of diameter  $D_j$  strikes a fixed cone and deflects back as a conical sheet. Find the cone angle  $\theta$  for which the restraining force  $F = (3/2)\rho A_j V_j^2$ .

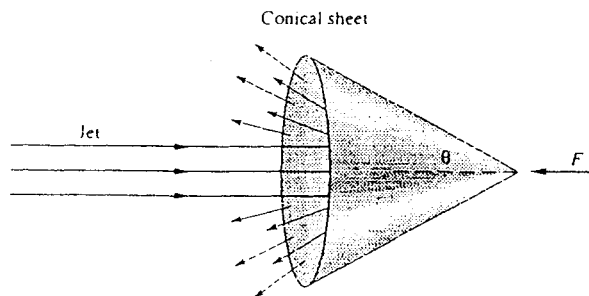


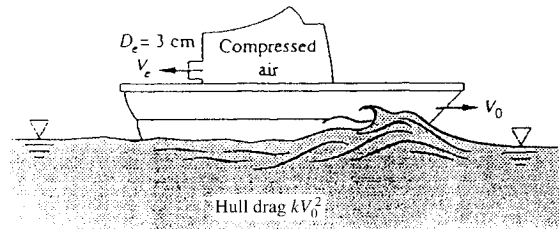
Fig. P3.47

**Solution:** Let the CV enclose the cone, the jet, and the sheet. Then,

$$\sum F_x = -F = \dot{m}_{\text{out}} u_{\text{out}} - \dot{m}_{\text{in}} u_{\text{in}} = \dot{m}(-V_j \cos \theta) - \dot{m}V_j, \quad \text{where } \dot{m} = \rho A_j V_j$$

$$\text{Solve for } F = \rho A_j V_j^2 (1 + \cos \theta) = \frac{3}{2} \rho A_j V_j^2 \quad \text{if } \cos \theta = \frac{1}{2} \quad \text{or } \theta = 60^\circ \quad \text{Ans.}$$

**3.48** The small boat is driven at steady speed  $V_o$  by compressed air issuing from a 3-cm-diameter hole at  $V_e = 343$  m/s and  $p_e = 1$  atm,  $T_e = 30^\circ\text{C}$ . Neglect air drag. The hull drag is  $kV_o^2$ , where  $k = 19 \text{ N}\cdot\text{s}^2/\text{m}^2$ . Estimate the boat speed  $V_o$ .



**Fig. P3.48**

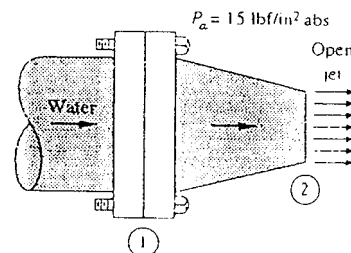
**Solution:** For a CV enclosing the boat and moving to the right at boat speed  $V_o$ , the air appears to leave the left side at speed  $(V_o + V_e)$ . The air density is  $p_e/RT_e \approx 1.165 \text{ kg/m}^3$ . The only mass flow across the CS is the air moving to the left. The force balance is

$$\sum F_x = -\text{Drag} = -kV_o^2 = \dot{m}_{\text{out}} u_{\text{out}} = [\rho_e A_e (V_o + V_e)](-V_o - V_e),$$

$$\text{or: } \rho_e A_e (V_o + V_e)^2 = kV_o^2, \quad (1.165)(\pi/4)(0.03)^2 (V_o + 343)^2 = 19V_o^2$$

$$\text{work out the numbers: } (V_o + 343) = V_o \sqrt{(23060)}, \quad \text{solve for } V_o = 2.27 \text{ m/s} \quad \text{Ans.}$$

**3.49** The horizontal nozzle in Fig. P3.49 has  $D_1 = 12$  in,  $D_2 = 6$  in, with  $p_1 = 38$  psia and  $V_2 = 56$  ft/s. For water at  $20^\circ\text{C}$ , find the force provided by the flange bolts to hold the nozzle fixed.



**Fig. P3.49**

**Solution:** For an open jet,  $p_2 = p_a = 15$  psia. Subtract  $p_a$  everywhere so the only nonzero pressure is  $p_1 = 38 - 15 = 23$  psig.

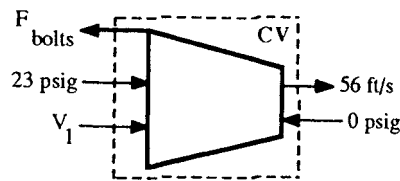
The mass balance yields the inlet velocity:

$$V_1 \frac{\pi}{4} (12)^2 = (56) \frac{\pi}{4} (6)^2, \quad V_1 = 14 \frac{\text{ft}}{\text{s}}$$

The density of water is 1.94 slugs per cubic foot. Then the horizontal force balance is

$$\sum F_x = -F_{\text{bolts}} + (23 \text{ psig}) \frac{\pi}{4} (12 \text{ in})^2 = \dot{m}_2 u_2 - \dot{m}_1 u_1 = \dot{m} (V_2 - V_1)$$

$$\text{Compute } F_{\text{bolts}} = 2601 - (1.94) \frac{\pi}{4} (1 \text{ ft})^2 \left( 14 \frac{\text{ft}}{\text{s}} \right) \left( 56 - 14 \frac{\text{ft}}{\text{s}} \right) \approx \mathbf{1700 \text{ lbf}} \quad \text{Ans.}$$



**3.50** The jet engine in Fig. P3.50 admits air at 20°C and 1 atm at (1), where  $A_1 = 0.5 \text{ m}^2$  and  $V_1 = 250 \text{ m/s}$ . The fuel-air ratio is 1:30. The air leaves section (2) at 1 atm,  $V_2 = 900 \text{ m/s}$ , and  $A_2 = 0.4 \text{ m}^2$ . Compute the test stand support reaction  $R_x$  needed.

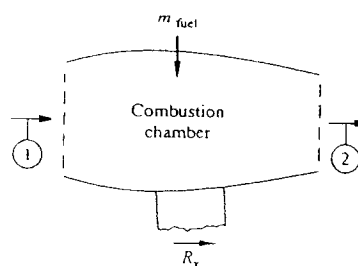


Fig. P3.50

**Solution:**  $\rho_1 = p/RT = 101350/[287(293)] = 1.205 \text{ kg/m}^3$ . For a CV enclosing the engine,

$$\dot{m}_1 = \rho_1 A_1 V_1 = (1.205)(0.5)(250) = 151 \text{ kg/s}, \quad \dot{m}_2 = 151 \left( 1 + \frac{1}{30} \right) = 156 \text{ kg/s}$$

$$\sum F_x = R_x = \dot{m}_2 u_2 - \dot{m}_1 u_1 - \dot{m}_{\text{fuel}} u_{\text{fuel}} = 156(900) - 151(250) - 0 \approx \mathbf{102,000 \text{ N}} \quad \text{Ans.}$$

**3.51** A liquid jet of velocity  $V_j$  and area  $A_j$  strikes a single 180° bucket on a turbine wheel rotating at angular velocity  $\Omega$ . Find an expression for the power  $P$  delivered. At what  $\Omega$  is the power a maximum? How does the analysis differ if there are many buckets, so the jet continually strikes at least one?

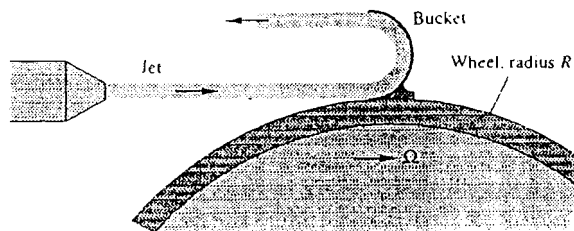


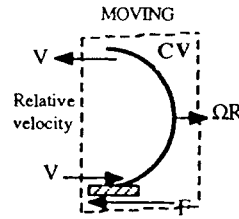
Fig. P3.51

**Solution:** Let the CV enclose the bucket and jet and let it move to the right at bucket velocity  $V = \Omega R$ , so that the jet enters the CV at relative speed  $(V_j - \Omega R)$ . Then,

$$\begin{aligned}\Sigma F_x &= -F_{\text{bucket}} = \dot{m}u_{\text{out}} - \dot{m}u_{\text{in}} \\ &= \dot{m}[-(V_j - \Omega R)] - \dot{m}[V_j - \Omega R]\end{aligned}$$

$$\text{or: } F_{\text{bucket}} = 2\dot{m}(V_j - \Omega R) = 2\rho A_j(V_j - \Omega R)^2,$$

$$\text{and the power is } P = \Omega R F_{\text{bucket}} = 2\rho A_j \Omega R (V_j - \Omega R)^2 \quad \text{Ans.}$$



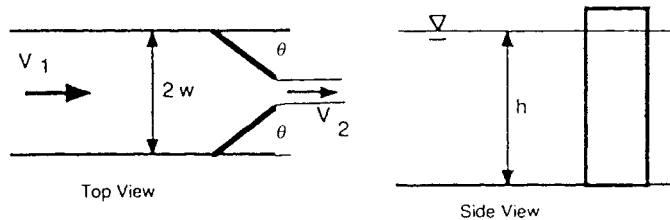
Maximum power is found by differentiating this expression:

$$\frac{dP}{d\Omega} = 0 \quad \text{if } \Omega R = \frac{V_j}{3} \quad \text{Ans.} \quad \left( \text{whence } P_{\text{max}} = \frac{8}{27} \rho A_j V_j^3 \right)$$

If there were many buckets, then the *full* jet mass flow would be available for work:

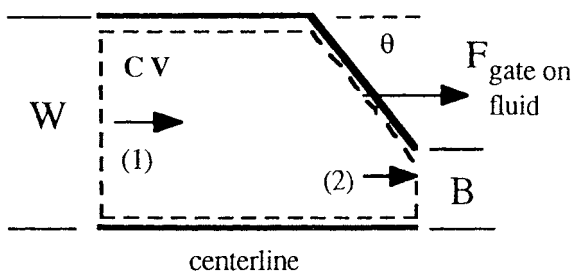
$$\dot{m}_{\text{available}} = \rho A_j V_j, \quad P = 2\rho A_j V_j \Omega R (V_j - \Omega R), \quad P_{\text{max}} = \frac{1}{2} \rho A_j V_j^3 \quad \text{at } \Omega R = \frac{V_j}{2} \quad \text{Ans.}$$

**3.52** The vertical gate in a water channel is partially open, as in Fig. P3.52. Assuming no change in water level and a hydrostatic pressure distribution, derive an expression for the streamwise force  $F_x$  on one-half of the gate as a function of  $(\rho, h, w, \theta, V_1)$ . Apply your result to the case of water at  $20^\circ\text{C}$ ,  $V_1 = 0.8 \text{ m/s}$ ,  $h = 2 \text{ m}$ ,  $w = 1.5 \text{ m}$ , and  $\theta = 50^\circ$ .



**Solution:** Let the CV enclose sections (1) and (2), the centerline, and the inside of the gate, as shown. The volume flows are

$$V_1 W h = V_2 B h, \quad \text{or: } V_2 = V_1 \frac{W}{B} = V_1 \frac{1}{1 - \sin \theta}$$



since  $B = W - W \sin \theta$ . The problem is unrealistically idealized by letting the water depth remain *constant*, whereas actually the depth would decrease at section 2. Thus we have no net hydrostatic pressure force on the CV in this model! The force balance reduces to

$$\sum F_x = F_{\text{gate on fluid}} = \dot{m}V_2 - \dot{m}V_1, \quad \text{where } \dot{m} = \rho W h V_1 \quad \text{and} \quad V_2 = V_1 / (1 - \sin \theta)$$

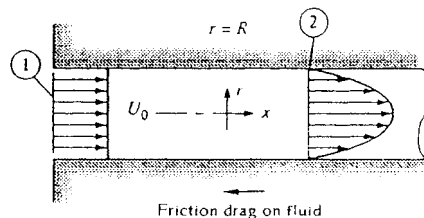
$$\text{Solve for } F_{\text{fluid on gate}} = -\rho W h V_1^2 \left[ \frac{1}{(1 - \sin \theta)} - 1 \right] \quad (\text{to the left}) \quad \text{Ans.}$$

This is unrealistic—the pressure force would turn this gate force around to the right. For the particular data given,  $W = 1.5 \text{ m}$ ,  $\theta = 50^\circ$ ,  $B = W(1 - \sin \theta) = 0.351 \text{ m}$ ,  $V_1 = 0.8 \text{ m/s}$ , thus  $V_2 = V_1 / (1 - \sin 50^\circ) = 3.42 \text{ m/s}$ ,  $\rho = 998 \text{ kg/m}^3$ ,  $h = 2 \text{ m}$ . Thus compute

$$F_{\text{fluid on gate}} = (998)(2)(1.5)(0.8)^2 \left[ \frac{1}{1 - \sin 50^\circ} - 1 \right] \approx \mathbf{6300 \text{ N} \leftarrow} \quad \text{Ans.}$$

**3.53** Consider incompressible flow in the entrance of a circular tube, as in Fig. P3.53. The inlet flow is uniform,  $u_1 = U_o$ . The flow at section 2 is developed pipe flow. Find the wall drag force  $F$  as a function of  $(p_1, p_2, \rho, U_o, R)$  if the flow at section 2 is

- (a) Laminar:  $u_2 = u_{\text{max}} \left( 1 - \frac{r^2}{R^2} \right)$
- (b) Turbulent:  $u_2 \approx u_{\text{max}} \left( 1 - \frac{r}{R} \right)^{1/7}$



**Fig. P3.53**

**Solution:** The CV encloses the inlet and outlet and is just inside the walls of the tube. We don't need to establish a relation between  $u_{\text{max}}$  and  $U_o$  by integration, because the results for these two profiles are given in the text. Note that  $U_o = u_{\text{av}}$  at section (2). Now use these results as needed for the balance of forces:

$$\sum F_x = (p_1 - p_2)\pi R^2 - F_{\text{drag}} = \int_0^R u_2 (\rho u_2 2\pi r dr) - U_o (\rho \pi R^2 U_o) = \rho \pi R^2 U_o^2 (\beta_2 - 1)$$

We simply insert the appropriate momentum-flux factors  $\beta$  from p. 136 of the text:

(a) Laminar:  $\mathbf{F}_{\text{drag}} = (\mathbf{p}_1 - \mathbf{p}_2)\pi R^2 - (1/3)\rho\pi R^2 U_0^2$  Ans. (a)

(b) Turbulent,  $\beta_2 \approx 1.020$ :  $\mathbf{F}_{\text{drag}} = (\mathbf{p}_1 - \mathbf{p}_2)\pi R^2 - 0.02\rho\pi R^2 U_0^2$  Ans. (b)

**3.54** For the pipe-flow reducing section of Fig. P3.54,  $D_1 = 8$  cm,  $D_2 = 5$  cm, and  $p_2 = 1$  atm. All fluids are at  $20^\circ\text{C}$ . If  $V_1 = 5$  m/s and the manometer reading is  $h = 58$  cm, estimate the total horizontal force resisted by the flange bolts.

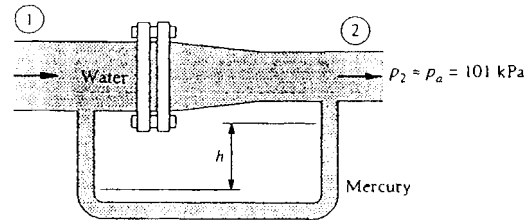


Fig. P3.54

**Solution:** Let the CV cut through the bolts and through section 2. For the given manometer reading, we may compute the upstream pressure:

$$p_1 - p_2 = (\gamma_{\text{merc}} - \gamma_{\text{water}})h = (132800 - 9790)(0.58 \text{ m}) \approx 71300 \text{ Pa (gage)}$$

Now apply conservation of mass to determine the exit velocity:

$$Q_1 = Q_2, \text{ or } (5 \text{ m/s})(\pi/4)(0.08 \text{ m})^2 = V_2(\pi/4)(0.05)^2, \text{ solve for } V_2 \approx 12.8 \text{ m/s}$$

Finally, write the balance of horizontal forces:

$$\sum F_x = -F_{\text{bolts}} + p_{1,\text{gage}}A_1 = \dot{m}(V_2 - V_1),$$

$$\text{or: } F_{\text{bolts}} = (71300)\frac{\pi}{4}(0.08)^2 - (998)\frac{\pi}{4}(0.08)^2(5.0)[12.8 - 5.0] \approx \mathbf{163 \text{ N}} \text{ Ans.}$$

**3.55** In Fig. P3.55 the jet strikes a vane which moves to the right at constant velocity  $V_c$  on a frictionless cart. Compute (a) the force  $F_x$  required to restrain the cart and (b) the power  $P$  delivered to the cart. Also find the cart velocity for which (c) the force  $F_x$  is a maximum and (d) the power  $P$  is a maximum.

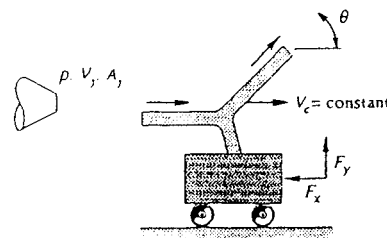


Fig. P3.55

**Solution:** Let the CV surround the vane and cart and move to the right at cart speed. The jet strikes the vane at *relative* speed  $V_j - V_c$ . The cart does not accelerate, so the horizontal force balance is

$$\sum F_x = -F_x = [\rho A_j (V_j - V_c)](V_j - V_c) \cos \theta - \rho A_j (V_j - V_c)^2$$

$$\text{or: } F_x = \rho A_j (V_j - V_c)^2 (1 - \cos \theta) \text{ Ans. (a)}$$



The power delivered is  $P = V_c F_x = \rho A_j V_c (V_j - V_c)^2 (1 - \cos \theta)$  Ans. (b)

The maximum force occurs when the cart is fixed, or:  $V_c = 0$  Ans. (c)

The maximum power occurs when  $dP/dV_c = 0$ , or:  $V_c = V_j/3$  Ans. (d)

**3.56** Water at 20°C flows steadily through the box in Fig. P3.56, entering station (1) at 2 m/s. Calculate the (a) horizontal; and (b) vertical forces required to hold the box stationary against the flow momentum.

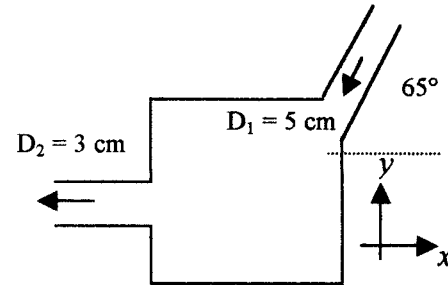


Fig. P3.56

**Solution:** (a) Summing horizontal forces,

$$\sum F_x = R_x = \dot{m}_{out} u_{out} - \dot{m}_{in} u_{in}$$

$$R_x = (998) \left[ \left( \frac{\pi}{4} \right) (0.03^2) (5.56) \right] (-5.56) - (998) \left[ \left( \frac{\pi}{4} \right) (0.05^2) (2) \right] (-2) (\cos 65^\circ)$$

$$= -18.46 \text{ N} \quad \text{Ans.}$$

$$R_x = 18.5 \text{ N} \quad \text{to the left}$$

$$\sum F_y = R_y = -\dot{m}_{in} u_{in} = -(998) \left( \frac{\pi}{4} \right) (0.05^2) (2) (-2 \sin 65^\circ) = 7.1 \text{ N} \quad \text{up}$$

**3.57** Water flows through the duct in Fig. P3.57, which is 50 cm wide and 1 m deep into the paper. Gate BC completely closes the duct when  $\beta = 90^\circ$ . Assuming one-dimensional flow, for what angle  $\beta$  will the force of the exit jet on the plate be 3 kN?

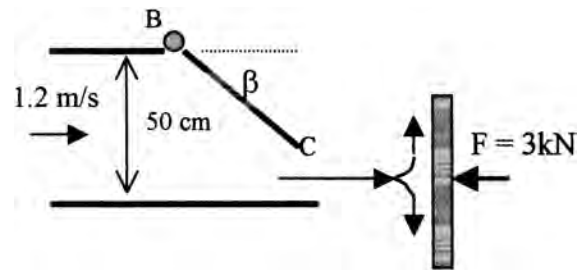


Fig. P3.57

**Solution:** The steady flow equation applied to the duct,  $Q_1 = Q_2$ , gives the jet velocity as  $V_2 = V_1(1 - \sin \beta)$ . Then for a force summation for a control volume around the jet's impingement area,

$$\sum F_x = F = \dot{m}_j V_j = \rho (h_1 - h_1 \sin \beta) (D) \left[ \frac{1}{1 - \sin \beta} \right]^2 (V_1^2)$$

$$\beta = \sin^{-1} \left[ 1 - \frac{\rho h_1 D V_1^2}{F} \right] = \sin^{-1} \left[ 1 - \frac{(998)(0.5)(1)(1.2)^2}{3000} \right] = 49.5^\circ \quad \text{Ans.}$$

**3.58** The water tank in Fig. P3.58 stands on a frictionless cart and feeds a jet of diameter 4 cm and velocity 8 m/s, which is deflected 60° by a vane. Compute the tension in the supporting cable.

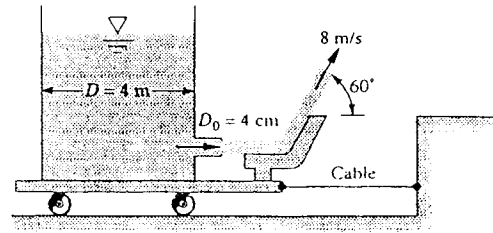


Fig. P3.58

**Solution:** The CV should surround the tank and wheels and cut through the cable and the exit water jet. Then the horizontal force balance is

$$\sum F_x = T_{\text{cable}} = \dot{m}_{\text{out}} u_{\text{out}} = (\rho A V_j) V_j \cos \theta = 998 \left( \frac{\pi}{4} \right) (0.04)^2 (8)^2 \cos 60^\circ = \mathbf{40 \text{ N}} \quad \text{Ans.}$$

**3.59** A pipe flow expands from (1) to (2), causing eddies as shown. Using the given CV and assuming  $p = p_1$  on the corner annular ring, show that the downstream pressure is given by, neglecting wall friction,

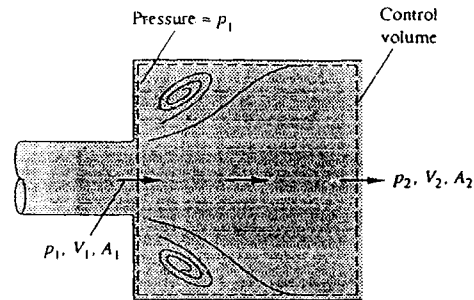


Fig. P3.59

$$p_2 = p_1 + \rho V_1^2 \left( \frac{A_1}{A_2} \right) \left( 1 - \frac{A_1}{A_2} \right)$$

**Solution:** From mass conservation,  $V_1 A_1 = V_2 A_2$ . The balance of x-forces gives

$$\sum F_x = p_1 A_1 + p_{\text{wall}} (A_2 - A_1) - p_2 A_2 = \dot{m} (V_2 - V_1), \quad \text{where } \dot{m} = \rho A_1 V_1, \quad V_2 = V_1 A_1 / A_2$$

$$\text{If } p_{\text{wall}} = p_1 \text{ as given, this reduces to } \mathbf{p_2 = p_1 + \rho \frac{A_1}{A_2} V_1^2 \left( 1 - \frac{A_1}{A_2} \right)} \quad \text{Ans.}$$

**3.60** Water at 20°C flows through the elbow in Fig. P3.60 and exits to the atmosphere. The pipe diameter is  $D_1 = 10$  cm, while  $D_2 = 3$  cm. At a weight flow rate of 150 N/s, the pressure  $p_1 = 2.3$  atm (gage). Neglecting the weight of water and elbow, estimate the force on the flange bolts at section 1.

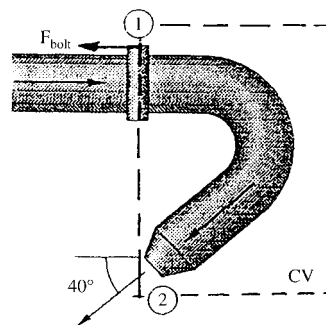


Fig. P3.60

**Solution:** First, from the weight flow, compute  $Q = (150 \text{ N/s})/(9790 \text{ N/m}^3) = 0.0153 \text{ m}^3/\text{s}$ . Then the velocities at (1) and (2) follow from the known areas:

$$V_1 = \frac{Q}{A_1} = \frac{0.0153}{(\pi/4)(0.1)^2} = 1.95 \frac{\text{m}}{\text{s}}; \quad V_2 = \frac{Q}{A_2} = \frac{0.0153}{(\pi/4)(0.03)^2} = 21.7 \frac{\text{m}}{\text{s}}$$

The mass flow is  $\rho A_1 V_1 = (998)(\pi/4)(0.1)^2(1.95) \approx 15.25 \text{ kg/s}$ . Then the balance of forces in the  $x$ -direction is:

$$\sum F_x = -F_{\text{bolts}} + p_1 A_1 = \dot{m} u_2 - \dot{m} u_1 = \dot{m}(-V_2 \cos 40^\circ - V_1)$$

$$\text{solve for } F_{\text{bolts}} = (2.3 \times 101350) \frac{\pi}{4} (0.1)^2 + 15.25(21.7 \cos 40^\circ + 1.95) \approx \mathbf{2100 \text{ N}} \quad \text{Ans.}$$

**3.61** A  $20^\circ\text{C}$  water jet strikes a vane on a tank with frictionless wheels, as shown. The jet turns and falls into the tank without spilling. If  $\theta = 30^\circ$ , estimate the horizontal force  $F$  needed to hold the tank stationary.

**Solution:** The CV surrounds the tank and wheels and cuts through the jet, as shown. We have to *assume that the splashing into the tank does not increase the  $x$ -momentum of the water in the tank*. Then we can write the CV horizontal force relation:

$$\sum F_x = -F = \frac{d}{dt} \left( \int u \rho dV \right)_{\text{tank}} - \dot{m}_{\text{in}} u_{\text{in}} = 0 - \dot{m} V_{\text{jet}} \quad \text{independent of } \theta$$

$$\text{Thus } F = \rho A_j V_j^2 = \left( 1.94 \frac{\text{slug}}{\text{ft}^3} \right) \frac{\pi}{4} \left( \frac{2}{12} \text{ ft} \right)^2 \left( 50 \frac{\text{ft}}{\text{s}} \right)^2 \approx \mathbf{106 \text{ lbf}} \quad \text{Ans.}$$

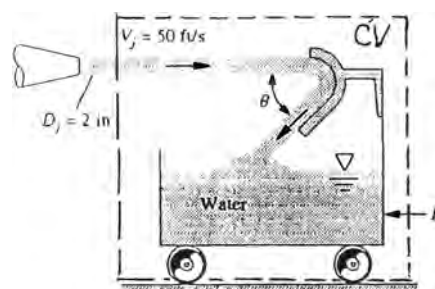


Fig. P3.61

**3.62** Water at  $20^\circ\text{C}$  exits to the standard sea-level atmosphere through the split nozzle in Fig. P3.62. Duct areas are  $A_1 = 0.02 \text{ m}^2$  and  $A_2 = A_3 = 0.008 \text{ m}^2$ . If  $p_1 = 135 \text{ kPa}$  (absolute) and the flow rate is  $Q_2 = Q_3 = 275 \text{ m}^3/\text{h}$ , compute the force on the flange bolts at section 1.

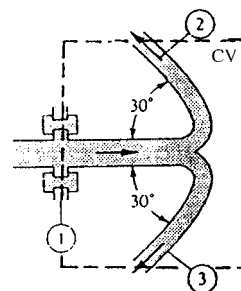


Fig. P3.62

**Solution:** With the known flow rates, we can compute the various velocities:

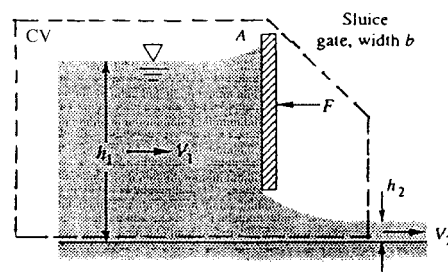
$$V_2 = V_3 = \frac{275/3600 \text{ m}^3/\text{s}}{0.008 \text{ m}^2} = 9.55 \frac{\text{m}}{\text{s}}; \quad V_1 = \frac{550/3600}{0.02} = 7.64 \frac{\text{m}}{\text{s}}$$

The CV encloses the split nozzle and cuts through the flange. The balance of forces is

$$\sum F_x = -F_{\text{bolts}} + p_{1,\text{gage}} A_1 = \rho Q_2 (-V_2 \cos 30^\circ) + \rho Q_3 (-V_3 \cos 30^\circ) - \rho Q_1 (+V_1),$$

$$\begin{aligned} \text{or: } F_{\text{bolts}} &= 2(998) \left( \frac{275}{3600} \right) (9.55 \cos 30^\circ) + 998 \left( \frac{550}{3600} \right) (7.64) + (135000 - 101350)(0.02) \\ &= 1261 + 1165 + 673 \approx \mathbf{3100 \text{ N}} \quad \text{Ans.} \end{aligned}$$

**3.63** The sluice gate in Fig. P3.63 can control and measure flow in open channels. At sections 1 and 2, the flow is uniform and the pressure is hydrostatic. The channel width is  $b$  into the paper. Neglecting bottom friction, derive an expression for the force  $F$  required to hold the gate. For what condition  $h_2/h_1$  is the force largest? For very low velocity  $V_1^2 \ll gh_1$ , for what value of  $h_2/h_1$  will the force be one-half of the maximum?



**Fig. P3.63**

**Solution:** The CV encloses the inlet and exit and the whole gate, as shown. From mass conservation, the velocities are related by

$$V_1 h_1 b = V_2 h_2 b, \quad \text{or: } V_2 = V_1 (h_1/h_2)$$

The bottom pressures at sections 1&2 equal  $\rho g h_1$  and  $\rho g h_2$ , respectively. The horizontal force balance is

$$\sum F_x = -F_{\text{gate}} + \frac{1}{2} \rho g h_1 (h_1 b) - \frac{1}{2} \rho g h_2 (h_2 b) = \dot{m} (V_2 - V_1), \quad \dot{m} = \rho h_1 b V_1$$

$$\text{Solve for } F_{\text{gate}} = \frac{1}{2} \rho g b h_1^2 [1 - (h_2/h_1)^2] - \rho h_1 b V_1^2 \left[ \frac{h_1}{h_2} - 1 \right] \quad \text{Ans.}$$

For everything held constant except  $h_2$ , the maximum force occurs when

$$\frac{dF}{dh_2} = 0 \quad \text{which yields } h_2 = (V_1^2 h_1^2 / g)^{1/3} \quad \text{or: } \frac{h_2}{h_1} \approx \left( \frac{V_1^2}{g h_1} \right)^{1/3} \quad \text{Ans.}$$

Finally, for very low velocity, only the first term holds:  $F \approx (1/2) \rho g b (h_1^2 - h_2^2)$ . In this case the maximum force occurs when  $h_2 = 0$ , or  $F_{\text{max}} = (1/2) \rho g b h_1^2$ . (Clearly this is the

special case of the earlier results for  $F_{\max}$  when  $V_1 = 0$ .) Then for this latter case of very low velocity,

$$F = (1/2)F_{\max} \quad \text{when } h_2 = h_1/\sqrt{2}. \quad \text{Ans.}$$

**3.64** The 6-cm-diameter 20°C water jet in Fig. P3.64 strikes a plate containing a hole of 4-cm diameter. Part of the jet passes through the hole, and part is deflected. Determine the horizontal force required to hold the plate.

**Solution:** First determine the incoming flow and the flow through the hole:

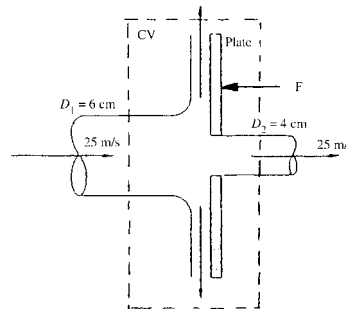


Fig. P3.64

$$Q_{\text{in}} = \frac{\pi}{4}(0.06)^2(25) = 0.0707 \frac{\text{m}^3}{\text{s}}, \quad Q_{\text{hole}} = \frac{\pi}{4}(0.04)^2(25) = 0.0314 \frac{\text{m}^3}{\text{s}}$$

Then, for a CV enclosing the plate and the two jets, the horizontal force balance is

$$\begin{aligned} \sum F_x &= -F_{\text{plate}} = \dot{m}_{\text{hole}} u_{\text{hole}} + \dot{m}_{\text{upper}} u_{\text{upper}} + \dot{m}_{\text{lower}} u_{\text{lower}} - \dot{m}_{\text{in}} u_{\text{in}} \\ &= (998)(0.0314)(25) + 0 + 0 - (998)(0.0707)(25) \\ &= 784 - 1764, \quad \text{solve for } \mathbf{F \approx 980 \text{ N (to left)}} \quad \text{Ans.} \end{aligned}$$

**3.65** The box in Fig. P3.65 has three 0.5-in holes on the right side. The volume flows of 20°C water shown are steady, but the details of the interior are not known. Compute the force, if any, which this water flow causes on the box.

**Solution:** First we need to compute the velocities through the various holes:

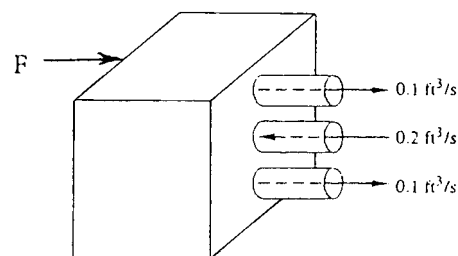


Fig. P3.65

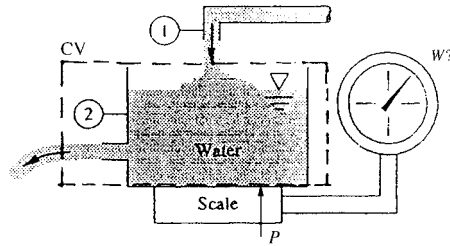
$$V_{\text{top}} = V_{\text{bottom}} = \frac{0.1 \text{ ft}^3/\text{s}}{(\pi/4)(0.5/12)^2} = 73.3 \text{ ft/s}; \quad V_{\text{middle}} = 2V_{\text{top}} = 146.6 \text{ ft/s}$$

Pretty fast, but do-able, I guess. Then make a force balance for a CV enclosing the box:

$$\sum F_x = F_{\text{box}} = -\dot{m}_{\text{in}} u_{\text{in}} + 2\dot{m}_{\text{top}} u_{\text{top}}, \quad \text{where } u_{\text{in}} = -V_{\text{middle}} \quad \text{and} \quad u_{\text{top}} = V_{\text{top}}$$

$$\text{Solve for } F_{\text{box}} = (1.94)(0.2)(146.6) + 2(1.94)(0.1)(73.3) \approx \mathbf{85 \text{ lbf}} \quad \text{Ans.}$$

**3.66** The tank in Fig. P3.66 weighs 500 N empty and contains 600 L of water at 20°C. Pipes 1 and 2 have  $D = 6$  cm and  $Q = 300$  m<sup>3</sup>/hr. What should the scale reading  $W$  be, in newtons?



**Fig. P3.66**

**Solution:** Let the CV surround the tank, cut through the two jets, and slip just under the tank bottom, as shown. The relevant jet velocities are

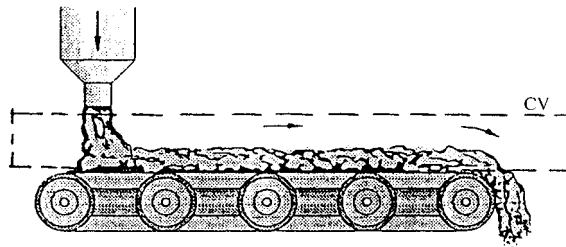
$$V_1 = V_2 = \frac{Q}{A} = \frac{(300/3600) \text{ m}^3/\text{s}}{(\pi/4)(0.06 \text{ m})^2} \approx 29.5 \text{ m/s}$$

The scale reads force “P” on the tank bottom. Then the vertical force balance is

$$\sum F_z = P - W_{\text{tank}} - W_{\text{water}} = \dot{m}_2 v_2 - \dot{m}_1 v_1 = \dot{m}[0 - (-V_1)]$$

$$\text{Solve for } P = 500 + 9790(0.6 \text{ m}^3) + 998 \left( \frac{300}{3600} \right) (29.5) \approx \mathbf{8800 \text{ N}} \quad \text{Ans.}$$

**3.67** Gravel is dumped from a hopper, at a rate of 650 N/s, onto a moving belt, as in Fig. P3.67. The gravel then passes off the end of the belt. The drive wheels are 80 cm in diameter and rotate clockwise at 150 r/min. Neglecting system friction and air drag, estimate the power required to drive this belt.



**Fig. P3.67**

**Solution:** The CV goes under the gravel on the belt and cuts through the inlet and outlet gravel streams, as shown. The no-slip belt velocity must be

$$V_{\text{belt}} = V_{\text{outlet}} = \Omega R_{\text{wheel}} = \left[ 150 \frac{\text{rev}}{\text{min}} 2\pi \frac{\text{rad}}{\text{rev}} \frac{1 \text{ min}}{60 \text{ s}} \right] (0.4 \text{ m}) \approx 6.28 \frac{\text{m}}{\text{s}}$$

Then the belt applies tangential force  $F$  to the gravel, and the force balance is

$$\sum F_x = F_{\text{on belt}} = \dot{m}_{\text{out}} u_{\text{out}} - \dot{m}_{\text{in}} u_{\text{in}}, \quad \text{but } u_{\text{in}} = 0.$$

$$\text{Then } F_{\text{belt}} = \dot{m} V_{\text{out}} = \left( \frac{650}{9.81} \frac{\text{kg}}{\text{s}} \right) \left( 6.28 \frac{\text{m}}{\text{s}} \right) = 416 \text{ N}$$

The power required to drive the belt is  $P = FV_{\text{belt}} = (416)(6.28) \approx \mathbf{2600 \text{ W}}$  *Ans.*

**3.68** The rocket in Fig. P3.68 has a supersonic exhaust, and the exit pressure  $p_e$  is not necessarily equal to  $p_a$ . Show that the force  $F$  required to hold this rocket on the test stand is  $F = \rho_e A_e V_e^2 + A_e(p_e - p_a)$ . Is this force  $F$  what we term the *thrust* of the rocket?

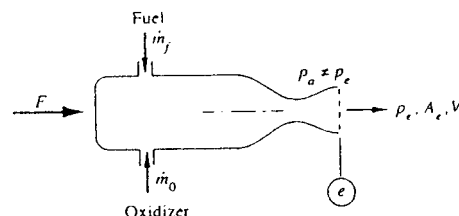


Fig. P3.68

**Solution:** The appropriate CV surrounds the entire rocket and cuts through the exit jet. Subtract  $p_a$  everywhere so only exit pressure  $\neq 0$ . The horizontal force balance is

$$\sum F_x = F - (p_e - p_a)A_e = \dot{m}_e u_e - \dot{m}_f u_f - \dot{m}_o u_o, \quad \text{but } u_f = u_o = 0, \quad \dot{m}_e = \rho_e A_e V_e$$

$$\text{Thus } \mathbf{F = \rho_e A_e V_e^2 + (p_e - p_a)A_e} \quad (\text{the } \underline{\text{thrust}}) \quad \text{Ans.}$$

**3.69** A uniform rectangular plate, 40 cm long and 30 cm deep into the paper, hangs in air from a hinge at its top, 30-cm side. It is struck in its center by a horizontal 3-cm-diameter jet of water moving at 8 m/s. If the gate has a mass of 16 kg, estimate the angle at which the plate will hang from the vertical.

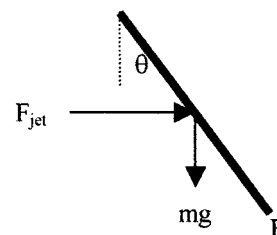


Fig. P3.69

**Solution:** The plate orientation can be found through force and moment balances,

$$\sum F_x = F_j = -\dot{m}_{in} u_{in} = -(998) \left( \frac{\pi}{4} \right) (0.03^2) (8^2) = 45.1 \text{ N}$$

$$\sum M_B = 0 = -(45)(0.02)(\sin \theta) + (16)(9.81)(0.02)(\cos \theta) \quad \theta = \mathbf{16^\circ}$$

**3.70** The dredger in Fig. P3.70 is loading sand (SG = 2.6) onto a barge. The sand leaves the dredger pipe at 4 ft/s with a weight flux of 850 lbf/s. Estimate the tension on the mooring line caused by this loading process.

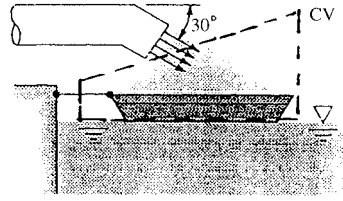


Fig. P3.70

**Solution:** The CV encloses the boat and cuts through the cable and the sand flow jet. Then,

$$\sum F_x = -T_{\text{cable}} = -\dot{m}_{\text{sand}} u_{\text{sand}} = -\dot{m} V_{\text{sand}} \cos \theta,$$

$$\text{or: } T_{\text{cable}} = \left( \frac{850}{32.2} \frac{\text{slug}}{\text{s}} \right) \left( 4 \frac{\text{ft}}{\text{s}} \right) \cos 30^\circ \approx \mathbf{91 \text{ lbf}} \quad \text{Ans.}$$

**3.71** Suppose that a deflector is deployed at the exit of the jet engine of Prob. 3.50, as shown in Fig. P3.71. What will the reaction  $R_x$  on the test stand be now? Is this reaction sufficient to serve as a braking force during airplane landing?

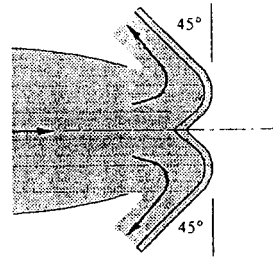


Fig. P3.71

**Solution:** From Prob. 3.50, recall that the essential data was

$$V_1 = 250 \text{ m/s}, \quad V_2 = 900 \text{ m/s}, \quad \dot{m}_1 = 151 \text{ kg/s}, \quad \dot{m}_2 = 156 \text{ kg/s}$$

The CV should enclose the entire engine and also the deflector, cutting through the support and the 45° exit jets. Assume (unrealistically) that the exit velocity is *still* 900 m/s. Then,

$$\sum F_x = R_x = \dot{m}_{\text{out}} u_{\text{out}} - \dot{m}_{\text{in}} u_{\text{in}}, \quad \text{where } u_{\text{out}} = -V_{\text{out}} \cos 45^\circ \quad \text{and} \quad u_{\text{in}} = V_1$$

$$\text{Then } R_x = -156(900 \cos 45^\circ) - 151(250) = -137,000 \text{ N}$$

**The support reaction is to the left and equals 137 kN** Ans.

**3.72** A thick elliptical cylinder immersed in a water stream creates the idealized wake shown. Upstream and downstream pressures are equal, and  $U_0 = 4 \text{ m/s}$ ,  $L = 80 \text{ cm}$ . Find the drag force on the cylinder per unit width into the paper. Also compute the dimensionless drag coefficient  $C_D = 2F/(\rho U_0^2 bL)$ .

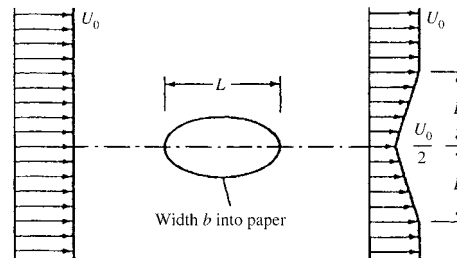


Fig. P3.72

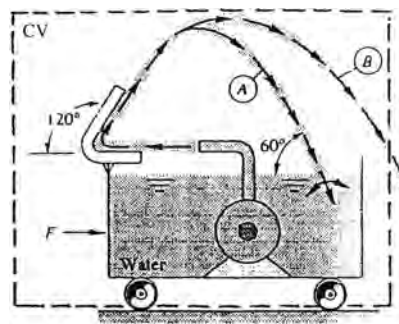


**Solution:** This is a ‘numerical’ version of the “analytical” body-drag [Prob. 3.44](#). The student still must make a CV analysis similar to [Prob. P3.44](#) of this Manual. The wake is exactly the same shape, so the result from [Prob. 3.44](#) holds here also:

$$F_{\text{drag}} = \frac{1}{3} \rho U_o^2 L b = \frac{1}{3} (998)(4)^2 (0.8)(1.0) \approx \mathbf{4260 \text{ N}} \quad \text{Ans.}$$

The drag coefficient is easily calculated from the above result:  $C_D = 2/3$ . *Ans.*

**3.73** A pump in a tank of water directs a jet at 45 ft/s and 200 gal/min against a vane, as shown in the figure. Compute the force  $F$  to hold the cart stationary if the jet follows (a) path A; or (b) path B. The tank holds 550 gallons of water at this instant.



**Fig. P3.73**

**Solution:** The CV encloses the tank and passes through jet B.

(a) For jet path A, no momentum flux crosses the CV, therefore  $\mathbf{F} = \mathbf{0}$  *Ans. (a)*

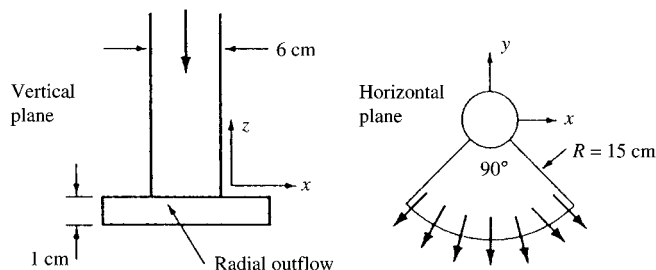
(b) For jet path B, there is momentum flux, so the  $x$ -momentum relation yields:

$$\sum F_x = F = \dot{m}_{\text{out}} u_{\text{out}} = \dot{m}_{\text{jet}} u_B$$

Now we don't really know  $u_B$  exactly, but we make the reasonable assumption that the jet trajectory is *frictionless* and maintains its horizontal velocity component, that is,  $u_B \approx V_{\text{jet}} \cos 60^\circ$ . Thus we can estimate

$$F = \dot{m} u_B = \left( 1.94 \frac{\text{slug}}{\text{ft}^3} \right) \left( \frac{200}{448.8} \frac{\text{ft}^3}{\text{s}} \right) (45 \cos 60^\circ) \approx \mathbf{19.5 \text{ lbf}} \quad \text{Ans. (b)}$$

**3.74** Water at 20°C flows down a vertical 6-cm-diameter tube at 300 gal/min, as in the figure. The flow then turns horizontally and exits through a 90° radial duct segment 1 cm thick, as shown. If the radial outflow is uniform and steady, estimate the forces ( $F_x$ ,  $F_y$ ,  $F_z$ ) required to support this system against fluid momentum changes.



**Solution:** First convert  $300 \text{ gal/min} = 0.01893 \text{ m}^3/\text{s}$ , hence the mass flow is  $\rho Q = 18.9 \text{ kg/s}$ . The vertical-tube velocity (down) is  $V_{\text{tube}} = 0.01893/[(\pi/4)(0.06)^2] = -6.69 \text{ k m/s}$ . The exit tube area is  $(\pi/2)R\Delta h = (\pi/2)(0.15)(0.01) = 0.002356 \text{ m}^2$ , hence  $V_{\text{exit}} = Q/A_{\text{exit}} = 0.01893/0.002356 = 8.03 \text{ m/s}$ . Now estimate the force components:

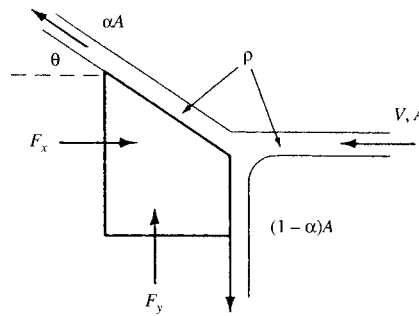
$$\sum F_x = \mathbf{F}_x = \int u_{\text{out}} d\dot{m}_{\text{out}} = \int_{-45^\circ}^{+45^\circ} -V_{\text{exit}} \sin\theta \rho \Delta h R d\theta \equiv \mathbf{0} \quad \text{Ans. (a)}$$

$$\sum F_y = \mathbf{F}_y = \int v_{\text{out}} d\dot{m}_{\text{out}} - \dot{m}v_{\text{in}} = \int_{-45^\circ}^{+45^\circ} -V_{\text{exit}} \cos\theta \rho \Delta h R d\theta - 0 = -V_{\text{exit}} \rho \Delta h R \sqrt{2}$$

or:  $\mathbf{F}_y = -(8.03)(998)(0.01)(0.15)\sqrt{2} \approx -17 \text{ N} \quad \text{Ans. (b)}$

$$\sum F_z = \mathbf{F}_z = \dot{m}(w_{\text{out}} - w_{\text{in}}) = (18.9 \text{ kg/s})[0 - (-6.69 \text{ m/s})] \approx +126 \text{ N} \quad \text{Ans. (c)}$$

**3.75** A liquid jet of density  $\rho$  and area  $A$  strikes a block and splits into two jets, as shown in the figure. All three jets have the same velocity  $V$ . The upper jet exits at angle  $\theta$  and area  $\alpha A$ , the lower jet turns down at  $90^\circ$  and area  $(1 - \alpha)A$ . (a) Derive a formula for the forces ( $F_x, F_y$ ) required to support the block against momentum changes. (b) Show that  $F_y = 0$  only if  $\alpha \geq 0.5$ . (c) Find the values of  $\alpha$  and  $\theta$  for which both  $F_x$  and  $F_y$  are zero.



**Solution:** (a) Set up the  $x$ - and  $y$ -momentum relations:

$$\sum F_x = F_x = \alpha \dot{m}(-V \cos\theta) - \dot{m}(-V) \quad \text{where } \dot{m} = \rho AV \text{ of the inlet jet}$$

$$\sum F_y = F_y = \alpha \dot{m}V \sin\theta + (1 - \alpha)\dot{m}(-V)$$

Clean this up for the final result:

$$F_x = \dot{m}V(1 - \alpha \cos\theta)$$

$$F_y = \dot{m}V(\alpha \sin\theta + \alpha - 1) \quad \text{Ans. (a)}$$

(b) Examining  $F_y$  above, we see that it can be zero only when,

$$\sin\theta = \frac{1 - \alpha}{\alpha}$$

But this makes no sense if  $\alpha < 0.5$ , hence  $\mathbf{F}_y = \mathbf{0}$  only if  $\alpha \geq 0.5$ . Ans. (b)

(c) Examining  $F_x$ , we see that it can be zero only if  $\cos\theta = 1/\alpha$ , which makes no sense unless  $\alpha = 1$ ,  $\theta = 0^\circ$ . This situation also makes  $F_x = 0$  above ( $\sin\theta = 0$ ). Therefore the only scenario for which both forces are zero is the trivial case for which all the flow goes horizontally across a flat block:

$$F_x = F_y = 0 \quad \text{only if: } \alpha = 1, \theta = 0^\circ \quad \text{Ans. (c)}$$

**3.76** A two-dimensional sheet of water, 10 cm thick and moving at 7 m/s, strikes a fixed wall inclined at  $20^\circ$  with respect to the jet direction. Assuming frictionless flow, find (a) the normal force on the wall per meter of depth, and the widths of the sheet deflected (b) upstream, and (c) downstream along the wall.

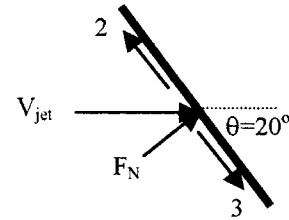


Fig. P3.76

**Solution:** (a) The force normal to the wall is due to the jet's momentum,

$$\sum F_N = -\dot{m}_{in} u_{in} = -(998)(0.1)(7^2)(\cos 70^\circ) = \mathbf{1670 \text{ N/m}} \quad \text{Ans.}$$

(b) Assuming  $V_1 = V_2 = V_3 = V_{jet}$ ,  $V_j A_1 = V_j A_2 + V_j A_3$  where,

$$A_2 = A_1 \sin\theta = (0.1)(1)(\sin 20^\circ) = 0.034 \text{ m} \approx \mathbf{3 \text{ cm}} \quad \text{Ans.}$$

(c) Similarly,  $A_3 = A_1 \cos\theta = (0.1)(1)(\cos 20^\circ) = 0.094 \text{ m} \approx \mathbf{9.4 \text{ cm}} \quad \text{Ans.}$

**3.77** Water at  $20^\circ\text{C}$  flows steadily through a reducing pipe bend, as in Fig. P3.77. Known conditions are  $p_1 = 350 \text{ kPa}$ ,  $D_1 = 25 \text{ cm}$ ,  $V_1 = 2.2 \text{ m/s}$ ,  $p_2 = 120 \text{ kPa}$ , and  $D_2 = 8 \text{ cm}$ . Neglecting bend and water weight, estimate the total force which must be resisted by the flange bolts.

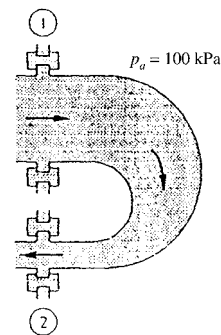


Fig. P3.77

**Solution:** First establish the mass flow and exit velocity:

$$\dot{m} = \rho_1 A_1 V_1 = 998 \left( \frac{\pi}{4} \right) (0.25)^2 (2.2) = 108 \frac{\text{kg}}{\text{s}} = 998 \left( \frac{\pi}{4} \right) (0.08)^2 V_2, \quad \text{or} \quad V_2 = 21.5 \frac{\text{m}}{\text{s}}$$

The CV surrounds the bend and cuts through the flanges. The force balance is

$$\sum F_x = -F_{\text{bolts}} + p_{1,\text{gage}}A_1 + p_{2,\text{gage}}A_2 = \dot{m}_2u_2 - \dot{m}_1u_1, \quad \text{where } u_2 = -V_2 \quad \text{and} \quad u_1 = V_1$$

$$\begin{aligned} \text{or } F_{\text{bolts}} &= (350000 - 100000) \frac{\pi}{4} (0.25)^2 + (120000 - 100000) \frac{\pi}{4} (0.08)^2 + 108(21.5 + 2.2) \\ &= 12271 + 101 + 2553 \approx \mathbf{14900 \text{ N}} \quad \text{Ans.} \end{aligned}$$

**3.78** A fluid jet of diameter  $D_1$  enters a cascade of moving blades at absolute velocity  $V_1$  and angle  $\beta_1$ , and it leaves at absolute velocity  $V_2$  and angle  $\beta_2$ , as in Fig. P3.78. The blades move at velocity  $u$ . Derive a formula for the power  $P$  delivered to the blades as a function of these parameters.

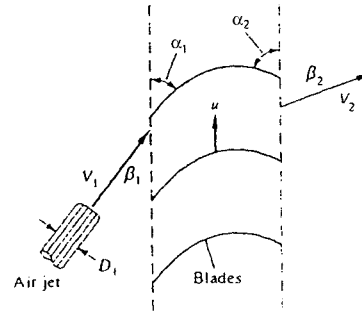
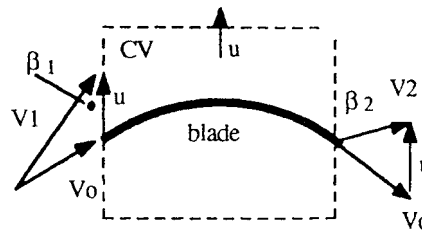


Fig. P3.78

**Solution:** Let the CV enclose the blades and move upward at speed  $u$ , so that the flow appears steady in that frame, as shown at right. The relative velocity  $V_o$  may be eliminated by the law of cosines:

$$\begin{aligned} V_o^2 &= V_1^2 + u^2 - 2V_1u \cos \beta_1 \\ &= V_2^2 + u^2 - 2V_2u \cos \beta_2 \end{aligned}$$

solve for  $u = \frac{(1/2)(V_1^2 - V_2^2)}{V_1 \cos \beta_1 - V_2 \cos \beta_2}$



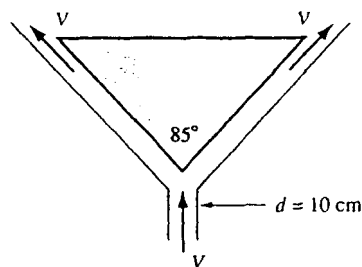
Then apply momentum in the direction of blade motion:

$$\sum F_y = F_{\text{vanes}} = \dot{m}_{\text{jet}}(V_{o1y} - V_{o2y}) = \dot{m}(V_1 \cos \beta_1 - V_2 \cos \beta_2), \quad \dot{m} = \rho A_1 V_1$$

The power delivered is  $P = Fu$ , which causes the parenthesis “ $\cos \beta$ ” terms to cancel:

$$\mathbf{P = Fu = \frac{1}{2} \dot{m}_{\text{jet}} (V_1^2 - V_2^2)} \quad \text{Ans.}$$

**3.79** Air at 20°C and 1 atm enters the bottom of an 85° conical flowmeter duct at a mass flow rate of 0.3 kg/s, as shown in the figure. It supports a centered conical body by steady annular flow around the cone and exits at the same velocity as it enters. Estimate the weight of the body in newtons.



**Solution:** First estimate the velocity from the known inlet duct size:

$$\rho_{air} = \frac{p}{RT} = \frac{101350}{287(293)} = 1.205 \frac{\text{kg}}{\text{m}^3},$$

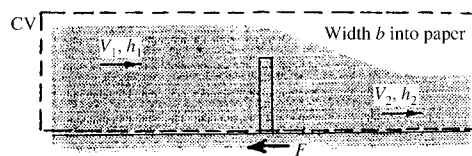
$$\text{thus } \dot{m} = 0.3 = \rho AV = (1.205) \frac{\pi}{4} (0.1)^2 V, \quad \text{solve } \mathbf{V = 31.7 \frac{m}{s}}$$

Then set up the vertical momentum equation, the unknown is the body weight:

$$\sum F_z = -W = \dot{m}V \cos 42.5^\circ - \dot{m}V = \dot{m}V(\cos 42.5^\circ - 1)$$

$$\text{Thus } \mathbf{W_{cone} = (0.3)(31.7)(1 - \cos 42.5^\circ) = 2.5 \text{ N} \quad \text{Ans.}}$$

**3.80** A river (1) passes over a “drowned” weir as shown, leaving at a new condition (2). Neglect atmospheric pressure and assume hydrostatic pressure at (1) and (2). Derive an expression for the force  $F$  exerted by the river on the obstacle. Neglect bottom friction.



**Fig. P3.80**

**Solution:** The CV encloses (1) and (2) and cuts through the gate along the bottom, as shown. The volume flow and horizontal force relations give

$$V_1 b h_1 = V_2 b h_2$$

$$\sum F_x = -F_{weir} + \frac{1}{2} \rho g h_1 (h_1 b) - \frac{1}{2} \rho g h_2 (h_2 b) = (\rho h_1 b V_1)(V_2 - V_1)$$

Note that, except for the different geometry, the analysis is exactly the same as for the sluice gate in Prob. 3.63. The force result is the same, also:

$$\mathbf{F_{weir} = \frac{1}{2} \rho g b (h_1^2 - h_2^2) - \rho h_1 b V_1^2 \left( \frac{h_1}{h_2} - 1 \right) \quad \text{Ans.}}$$

**3.81** Torricelli's idealization of efflux from a hole in the side of a tank is  $V \approx \sqrt{2gh}$ , as shown in Fig. P3.81. The tank weighs 150 N when empty and contains water at 20°C. The tank bottom is on very smooth ice (static friction coefficient  $\zeta \approx 0.01$ ). For what water depth  $h$  will the tank just begin to move to the right?

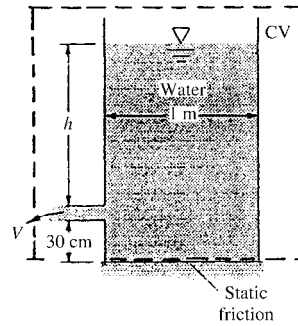


Fig. P3.81

**Solution:** The hole diameter is 9 cm. The CV encloses the tank as shown. The coefficient of static friction is  $\zeta = 0.01$ . The  $x$ -momentum equation becomes

$$\sum F_x = -\zeta W_{\text{tank}} = \dot{m}u_{\text{out}} = -\dot{m} V_{\text{hole}} = -\rho A V^2 = -\rho A (2gh)$$

$$\text{or: } 0.01 \left[ (9790) \frac{\pi}{4} (1 \text{ m})^2 (h + 0.3 + 0.09) + 150 \right] = 998 \left( \frac{\pi}{4} \right) (0.09)^2 (2)(9.81)h$$

Solve for  $h \approx 0.66 \text{ m}$  Ans.

**3.82** The model car in Fig. P3.82 weighs 17 N and is to be accelerated from rest by a 1-cm-diameter water jet moving at 75 m/s. Neglecting air drag and wheel friction, estimate the velocity of the car after it has moved forward 1 m.

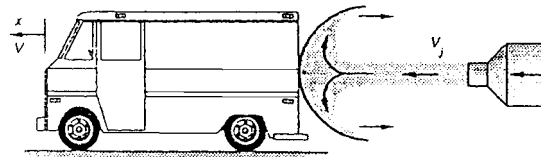


Fig. P3.82

**Solution:** The CV encloses the car, moves to the left at *accelerating* car speed  $V(t)$ , and cuts through the inlet and outlet jets, which leave the CS at *relative* velocity  $V_j - V$ . The force relation is Eq. (3.50):

$$\sum F_x - \int a_{\text{rel}} dm = 0 - m_{\text{car}} a_{\text{car}} = \dot{m}_{\text{out}} u_{\text{out}} - \dot{m}_{\text{in}} u_{\text{in}} = -2\dot{m}_{\text{jet}} (V_j - V),$$

$$\text{or: } m_{\text{car}} \frac{dV}{dt} = 2\rho A_j (V_j - V)^2$$

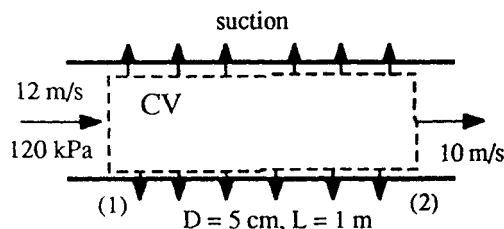
Except for the factor of “2,” this is identical to the “cart” analysis of Example 3.12 on page 140 of the text. The solution, for  $V = 0$  at  $t = 0$ , is given there:

$$V = \frac{V_j^2 K t}{1 + V_j K t}, \quad \text{where } K = \frac{2\rho A_j}{m_{\text{car}}} = \frac{2(998)(\pi/4)(0.01)^2}{(17/9.81)} = 0.0905 \text{ m}^{-1}$$

$$\text{Thus } V \text{ (in m/s)} = \frac{509t}{1+6.785t} \text{ and then compute distance } S = \int_0^t V dt$$

The initial acceleration is  $509 \text{ m/s}^2$ , quite large. Assuming the jet can follow the car without dipping, the car reaches  $S = 1 \text{ m}$  at  $t \approx 0.072 \text{ s}$ , where  $V \approx 24.6 \text{ m/s}$ . *Ans.*

**3.83** Gasoline at  $20^\circ\text{C}$  is flowing at  $V_1 = 12 \text{ m/s}$  in a 5-cm-diameter pipe when it encounters a 1-m length of uniform radial wall suction. After the suction, the velocity has dropped to  $10 \text{ m/s}$ . If  $p_1 = 120 \text{ kPa}$ , estimate  $p_2$  if wall friction is neglected.



**Solution:** The CV cuts through sections 1 and 2 and the inside of the walls. We compute the mass flow at each section, taking  $\rho \approx 680 \text{ kg/m}^3$  for gasoline:

$$\dot{m}_1 = 680 \left( \frac{\pi}{4} \right) (0.05)^2 (12) = 16.02 \frac{\text{kg}}{\text{s}}; \quad \dot{m}_2 = 680 \left( \frac{\pi}{4} \right) (0.05)^2 (10) = 13.35 \frac{\text{kg}}{\text{s}}$$

The difference,  $16.02 - 13.35 = 2.67 \text{ kg/s}$ , is sucked through the walls. If wall friction is neglected, the force balance (taking the momentum correction factors  $\beta \approx 1.0$ ) is:

$$\begin{aligned} \sum F_x &= p_1 A_1 - p_2 A_2 = \dot{m}_2 V_2 - \dot{m}_1 V_1 = (120000 - p_2) \frac{\pi}{4} (0.05)^2 \\ &= (13.35)(10) - (16.02)(12), \text{ solve for } p_2 \approx \mathbf{150 \text{ kPa}} \text{ } \textit{Ans.} \end{aligned}$$

**3.84** Air at  $20^\circ\text{C}$  and  $1 \text{ atm}$  flows in a 25-cm-diameter duct at  $15 \text{ m/s}$ , as in Fig. P3.84. The exit is choked by a  $90^\circ$  cone, as shown. Estimate the force of the airflow on the cone.

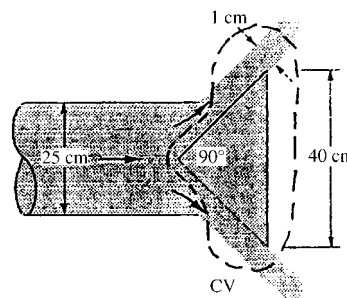


Fig. P3.84

**Solution:** The CV encloses the cone, as shown. We need to know exit velocity. The exit area is approximated as a ring of diameter  $40.7 \text{ cm}$  and thickness  $1 \text{ cm}$ :

$$Q = A_1 V_1 = \frac{\pi}{4} (0.25)^2 (15) = 0.736 \frac{\text{m}^3}{\text{s}} = A_2 V_2 \approx \pi (0.407) (0.01) V_2, \text{ or } V_2 \approx 57.6 \frac{\text{m}}{\text{s}}$$

The air density is  $\rho = p/RT = (101350)/[287(293)] \approx 1.205 \text{ kg/m}^3$ . We are not given any pressures on the cone so we consider momentum only. The force balance is

$$\sum F_x = F_{\text{cone}} = \dot{m}(u_{\text{out}} - u_{\text{in}}) = (1.205)(0.736)(57.6 \cos 45^\circ - 15) \approx \mathbf{22.8 \text{ N}} \quad \text{Ans.}$$

The force on the cone is *to the right* because we neglected pressure forces.

**3.85** The thin-plate orifice in Fig. P3.85 causes a large pressure drop. For 20°C water flow at 500 gal/min, with pipe  $D = 10 \text{ cm}$  and orifice  $d = 6 \text{ cm}$ ,  $p_1 - p_2 \approx 145 \text{ kPa}$ . If the wall friction is negligible, estimate the force of the water on the orifice plate.

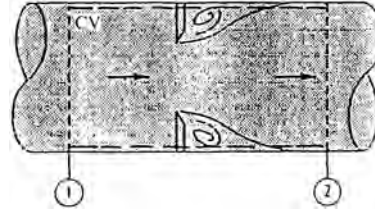


Fig. P3.85

**Solution:** The CV is inside the pipe walls, cutting through the orifice plate, as shown. At least to one-dimensional approximation,  $V_1 = V_2$ , so there is no momentum change. The force balance yields the force of the plate on the fluid:

$$\sum F_x = -F_{\text{plate on fluid}} + p_1 A_1 - p_2 A_2 - \tau_{\text{wall}} A_{\text{wall}} = \dot{m}(V_2 - V_1) \approx 0$$

$$\text{Since } \tau_{\text{wall}} \approx 0, \text{ we obtain } F_{\text{plate}} = (145000) \frac{\pi}{4} (0.1)^2 \approx \mathbf{1140 \text{ N}} \quad \text{Ans.}$$

The force of the fluid on the plate is opposite to the sketch, or to the right.

**3.86** For the water-jet pump of Prob. 3.36, add the following data:  $p_1 = p_2 = 25 \text{ lbf/in}^2$ , and the distance between sections 1 and 3 is 80 in. If the average wall shear stress between sections 1 and 3 is  $7 \text{ lbf/ft}^2$ , estimate the pressure  $p_3$ . Why is it higher than  $p_1$ ?

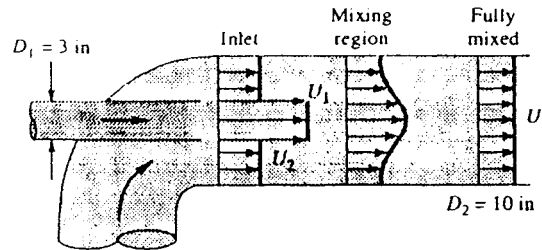


Fig. P3.36

**Solution:** The CV cuts through sections 1, 2, 3 and along the inside pipe walls. Recall from Prob. 3.36 that mass conservation led to the calculation  $\mathbf{V_3 \approx 6.33 \text{ m/s}}$ . Convert data to SI units:  $L = 80 \text{ in} = \underline{2.032 \text{ m}}$ ,  $p_1 = p_2 = 25 \text{ psi} = \underline{172.4 \text{ kPa}}$ , and  $\tau_{\text{wall}} = 7 \text{ psf} = \underline{335 \text{ Pa}}$ . We need mass flows for each of the three sections:

$$\dot{m}_1 = 998 \left( \frac{\pi}{4} \right) (0.0762)^2 (40) \approx 182 \frac{\text{kg}}{\text{s}};$$

$$\dot{m}_2 = 998 \left( \frac{\pi}{4} \right) [(0.254)^2 - (0.0762)^2] (3) \approx 138 \frac{\text{kg}}{\text{s}} \quad \text{and} \quad \dot{m}_3 \approx 182 + 138 \approx 320 \frac{\text{kg}}{\text{s}}$$



Then the horizontal force balance will yield the (high) downstream pressure:

$$\begin{aligned} \sum F_x &= p_1(A_1 + A_2) - p_3A_3 - \tau_{\text{wall}}\pi D_2L = \dot{m}_3V_3 - \dot{m}_2V_2 - \dot{m}_1V_1 \\ &= (172400 - p_3)\frac{\pi}{4}(0.254)^2 - 335\pi(0.254)(2.032) = 320(6.33) - 138(3) - 182(40) \end{aligned}$$

Solve for  $p_3 \approx 274000 \text{ Pa}$  Ans.

The pressure is high because the primary inlet kinetic energy at section (1) is converted by viscous mixing to pressure-type energy at the exit.

**3.87** Figure P3.87 simulates a *manifold* flow, with fluid removed from a porous wall or perforated section of pipe. Assume incompressible flow with negligible wall friction and small suction  $V_w \ll V_1$ . If  $(p_1, V_1, V_w, \rho, D)$  are known, derive expressions for (a)  $V_2$  and (b)  $p_2$ .

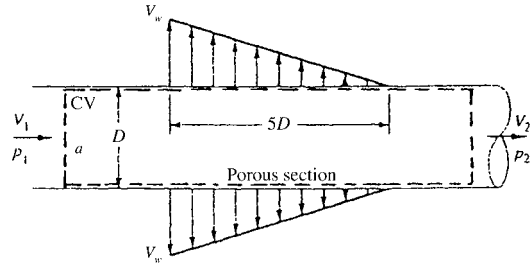


Fig. P3.87

**Solution:** The CV cuts through sections 1 and 2 and runs along the duct wall, as shown. Assuming incompressible flow, mass conservation gives

$$V_1A_1 = V_2A_2 + \int_0^{5D} V_w \left(1 - \frac{x}{5D}\right) \pi D dx = V_2\frac{\pi}{4}D^2 + 2.5\pi V_w D^2 = V_1\frac{\pi}{4}D^2$$

Assuming  $V_w \ll V_1$ , solve for  $V_2 = V_1 - 10V_w$  Ans. (a)

Then use this result while applying the momentum relation to the same CV:

$$\sum F_x = (p_1 - p_2)\frac{\pi}{4}D^2 - \int \tau_w dA_w = \dot{m}_2u_2 - \dot{m}_1u_1 + \int u_w d\dot{m}_w$$

Since  $\tau_w \approx 0$  and  $u_w \approx 0$  and the area  $A_1$  cancels out, we obtain the simple result

$$p_2 = p_1 + \rho(V_1^2 - V_2^2) = p_1 + 20\rho V_w(V_1 - 5V_w) \text{ Ans. (b)}$$

**3.88** The boat in Fig. P3.88 is jet-propelled by a pump which develops a volume flow rate  $Q$  and ejects water out the stem at velocity  $V_j$ . If the boat drag force is  $F = kV^2$ , where  $k$  is a constant, develop a formula for the steady forward speed  $V$  of the boat.

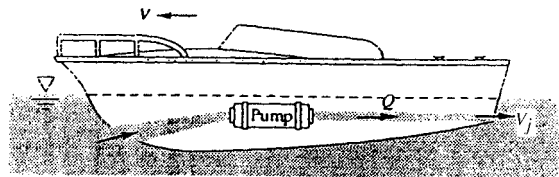


Fig. P3.88

**Solution:** Let the CV move to the left at boat speed  $V$  and enclose the boat and the pump's inlet and exit. Then the momentum relation is

$$\sum F_x = kV^2 = \dot{m}_{\text{pump}}(V_j + V - V_{\text{inlet}}) \approx \rho Q(V_j + V) \quad \text{if we assume } V_{\text{inlet}} \ll V_j$$

If, further,  $V \ll V_j$ , then the approximate solution is:  $V \approx (\rho Q V_j / k)^{1/2}$  *Ans.*

If  $V$  and  $V_j$  are comparable, then we solve a quadratic equation:

$$V \approx \zeta + [\zeta^2 + 2\zeta V_j]^{1/2}, \quad \text{where } \zeta = \frac{\rho Q}{2k} \quad \text{Ans.}$$

**3.89** Consider Fig. P3.36 as a general problem for analysis of a mixing ejector pump. If all conditions ( $p$ ,  $\rho$ ,  $V$ ) are known at sections 1 and 2 and if the wall friction is negligible, derive formulas for estimating (a)  $V_3$  and (b)  $p_3$ .

**Solution:** Use the CV in Prob. 3.86 but use symbols throughout. For volume flow,

$$V_1 \frac{\pi}{4} D_1^2 + V_2 \frac{\pi}{4} (D_2^2 - D_1^2) = V_3 \frac{\pi}{4} D_2^2, \quad \text{or: } V_3 = V_1 \alpha + V_2 (1 - \alpha), \quad \alpha = (D_1/D_2)^2 \quad (\text{A})$$

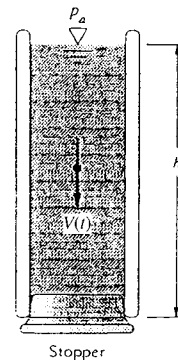
Now apply  $x$ -momentum, assuming (quite reasonably) that  $p_1 = p_2$ :

$$(p_1 - p_3) \frac{\pi}{4} D_2^2 - \tau_w \pi D_2 L = \rho \frac{\pi}{4} D_2^2 V_3^2 - \rho \frac{\pi}{4} (D_2^2 - D_1^2) V_2^2 - \rho \frac{\pi}{4} D_1^2 V_1^2$$

$$\text{Clean up: } p_3 = p_1 - \frac{4L\tau_w}{D_2} + \rho \left[ \alpha V_1^2 + (1 - \alpha) V_2^2 - V_3^2 \right] \quad \text{where } \alpha = \left( \frac{D_1}{D_2} \right)^2 \quad \text{Ans.}$$

You have to insert  $V_3$  into this answer from Eq. (A) above, but the algebra is messy.

**3.90** As shown in Fig. P3.90, a liquid column of height  $h$  is confined in a vertical tube of cross-sectional area  $A$  by a stopper. At  $t = 0$  the stopper is suddenly removed, exposing the bottom of the liquid to atmospheric pressure. Using a control-volume analysis of mass and vertical momentum, derive the differential equation for the downward motion  $V(t)$  of the liquid. Assume one-dimensional, incompressible, frictionless flow.



**Fig. P3.90**

**Solution:** Let the CV enclose the cylindrical blob of liquid. With density, area, and the blob volume constant, mass conservation requires that  $V = V(t)$  only. The CV accelerates downward at blob speed  $V(t)$ . Vertical (downward) force balance gives

$$\Sigma F_{\text{down}} - \int a_{\text{rel}} dm = \frac{d}{dt} \left( \int V_{\text{down}} \rho dv \right) + \dot{m}_{\text{out}} V_{\text{out}} - \dot{m}_{\text{in}} V_{\text{in}} = 0$$

$$\text{or: } m_{\text{blob}} g + \Delta p A - \tau_w A_w - a m_{\text{blob}} = 0$$

$$\text{Since } \Delta p = 0 \text{ and } \tau = 0, \text{ we are left with } \mathbf{a}_{\text{blob}} = \frac{d\mathbf{V}}{dt} = \mathbf{g} \quad \text{Ans.}$$

**3.91** Extend Prob. 3.90 to include a linear (laminar) average wall shear stress of the form  $\tau \approx cV$ , where  $c$  is a constant. Find  $V(t)$ , assuming that the wall area remains constant.

**Solution:** The downward momentum relation from Prob. 3.90 above now becomes

$$0 = m_{\text{blob}} g - \tau_w \pi DL - m_{\text{blob}} \frac{dV}{dt}, \text{ or } \frac{dV}{dt} + \zeta V = g, \text{ where } \zeta = \frac{c\pi DL}{m_{\text{blob}}}$$

where we have inserted the laminar shear  $\tau = cV$ . The blob mass equals  $\rho(\pi/4)D^2L$ . For  $V = 0$  at  $t = 0$ , the solution to this equation is

$$\mathbf{V} = \frac{\mathbf{g}}{\zeta} (1 - e^{-\zeta t}), \text{ where } \zeta = \frac{c\pi DL}{m_{\text{blob}}} = \frac{4c}{\rho D} \quad \text{Ans.}$$

**3.92** A more involved version of Prob. 3.90 is the elbow-shaped tube in Fig. P3.92, with constant cross-sectional area  $A$  and diameter  $D \ll h, L$ . Assume incompressible flow, neglect friction, and derive a differential equation for  $dV/dt$  when the stopper is opened. *Hint:* Combine two control volumes, one for each leg of the tube.

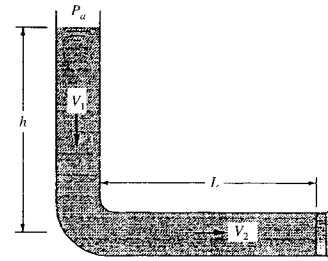
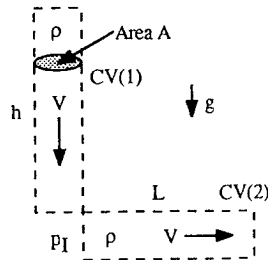


Fig. P3.92



**Solution:** Use two CV's, one for the vertical blob and one for the horizontal blob, connected as shown by pressure.

From mass conservation,  $V_1 = V_2 = V(t)$ . For CV's #1 and #2,

$$\sum F_{\text{down}} - \int a_{\text{rel}} dm = \Delta(\dot{m}v) = 0 = (p_{\text{atm}} - p_1)A + \rho gAh - m_1 \frac{dV}{dt} \quad (\text{No. 1})$$

$$\sum F_x - \int a_{\text{rel}} dm = \Delta(\dot{m}u) = 0 = (p_1 - p_{\text{atm}})A + 0 - m_2 \frac{dV}{dt} \quad (\text{No. 2})$$

Add these two together. The pressure terms cancel, and we insert the two blob masses:

$$\rho gAh - (\rho Ah + \rho AL) \frac{dV}{dt} = 0, \quad \text{or:} \quad \frac{dV}{dt} = g \frac{h}{L+h} \quad \text{Ans.}$$

**3.93** Extend Prob. 3.92 to include a linear (laminar) average wall shear stress of the form  $\tau \approx cV$ , where  $c$  is a constant. Find  $V(t)$ , assuming that the wall area remains constant.

**Solution:** For the same two CV's as in Prob. 3.92 above, we add wall shears:

$$\Delta pA + \rho gAh - (cV)\pi Dh = m_1 \frac{dV}{dt} \quad (\text{No. 1})$$

$$-\Delta pA + 0 - (cV)\pi DL = m_2 \frac{dV}{dt} \quad (\text{No. 2})$$

Add together, divide by  $(\rho A)$ ,  $A = \pi D^2/4$ , and rearrange into a 1st order linear ODE:

$$\frac{dV}{dt} + \left( \frac{4c}{\rho D} \right) V = \frac{gh}{L+h} \quad \text{subject to} \quad V=0 \quad \text{at} \quad t=0, \quad h=h_0 \quad \text{Ans.}$$

The blob length  $(L+h)$  could be assumed constant, but  $h = h(t)$ . We could substitute for  $V = -dh/dt$  and rewrite this relation as a 2nd order ODE for  $h(t)$ , but we will not proceed any further with an analytical *solution* to this differential equation.

**3.94** Attempt a numerical solution of Prob. 3.93 for SAE 30 oil at 20°C. Let  $h = 20$  cm,  $L = 15$  cm, and  $D = 4$  mm. Use the laminar shear approximation from Sec. 6.4:  $\tau \approx 8\mu V/D$ , where  $\mu$  is the fluid viscosity. Account for the decrease in wall area wetted by the fluid. Solve for the time required to empty (a) the vertical leg and (b) the horizontal leg.

**Solution:** For SAE 30 oil,  $\mu \approx 0.29$  kg/(m·s) and  $\rho \approx 917$  kg/m<sup>3</sup>. For laminar flow as given,  $c = 8\mu/D$ , so the coefficient  $(4c/\rho D) = 4[8(0.29)/0.004]/[917(0.004)] \approx 632$  s<sup>-1</sup>. [The flow is highly damped.] Then the basic differential equation becomes

$$\frac{dV}{dt} + 632V = \frac{9.81h}{0.15+h}, \quad \text{with} \quad h = 0.2 - \int_0^t V dt \quad \text{and} \quad V(0) = 0$$

We may solve this numerically, e.g., by Runge-Kutta or a spreadsheet or whatever. After  $h$  reaches zero, we keep  $h = 0$  and should decrease  $L = 0.15 - \int V dt$  until  $L = 0$ . The results are perhaps startling: the highly damped system (lubricating oil in a capillary tube) quickly reaches a ‘terminal’ (near-zero-acceleration) velocity in 16 ms and then slowly moves down until  $h \approx 0$ ,  $t \approx 70$  s. The flow stops, and the horizontal leg will not empty.

The computed values of  $V$  and  $h$  for the author’s solution are as follows:

t, s:	0	5	10	15	20	30	40	50	60	70
V, m/s:	0	0.008	0.007	0.006	0.005	0.003	0.001	0.000	0.000	0.000
h, m:	0.2	0.162	0.121	0.089	0.063	0.028	0.011	0.004	0.001	<b>0.000</b>

---

**3.95** Attempt a numerical solution of Prob. 3.93 for mercury at 20°C. Let  $h = 20$  cm,  $L = 15$  cm, and  $D = 4$  mm. For mercury the flow will be *turbulent*, with the wall shear stress estimated from Sec. 6.4:  $\tau \approx 0.005\rho V^2$ , where  $\rho$  is the fluid density. Account for the decrease in wall area wetted by the fluid. Solve for the time required to empty (a) the vertical leg and (b) the horizontal leg. Compare with a frictionless flow solution.

**Solution:** For this turbulent case the differential equation becomes

$$-\tau\pi D(h+L) + \rho gAh = \rho A(h+L)\frac{dV}{dt}, \quad A = \frac{\pi}{4}D^2 \quad \text{and} \quad \tau = 0.005\rho V^2$$

$$\text{Clean this up and rewrite: } \frac{dV}{dt} + \frac{0.02V^2}{D} = \frac{gh}{h+L}, \quad V=0 \quad \text{and} \quad h=0.2 \text{ at } t=0$$

We insert  $L = 0.15$  m and  $d = 0.004$  m and solve numerically. Note that the fluid density and viscosity have been eliminated by this ‘highly turbulent flow’ assumption. This time the heavy, low-viscosity fluid does have momentum to empty the horizontal tube in **0.65 s**. The vertical tube is emptied ( $h = 0$ ) in approximately **0.34 sec**.

The computed values of  $V$  and  $h$  and  $L$  for the author’s solution are as follows:

t, s:	0	0.1	0.2	0.3	0.34	0.4	0.5	0.6	0.65
V, m/s	0	0.507	0.768	0.763	0.690	0.570	0.442	0.362	0.330
h, m:	0.2	0.173	0.107	0.029	<b>0.0</b>	0.0	0.0	0.0	0.0
L, m:	0.15	0.15	0.15	0.15	<b>0.15</b>	0.109	0.059	0.019	<b>0.0</b>

---

**3.96** Extend Prob. 3.90 to the case of the liquid motion in a frictionless U-tube whose liquid column is displaced a distance  $Z$  upward and then released, as in Fig. P3.96. Neglect the short horizontal leg and combine control-volume analyses for the left and right legs to derive a single differential equation for  $V(t)$  of the liquid column.

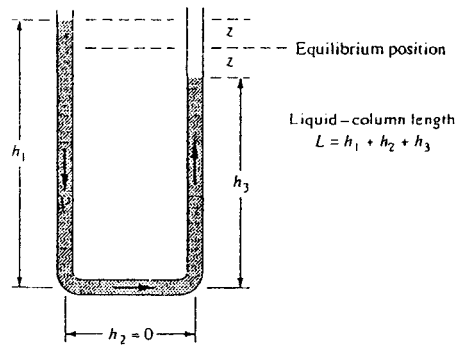
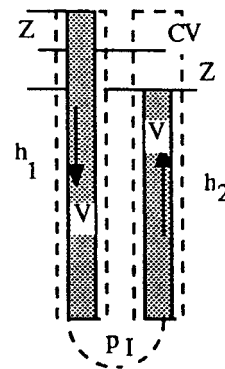


Fig. P3.96



**Solution:** As in Prob. 3.92, break it up into two moving CV's, one for each leg, as shown. By mass conservation, the velocity  $V(t)$  is the same in each leg. Let  $p_1$  be the bottom pressure in the (very short) cross-over leg. Neglect wall shear stress. Now apply vertical momentum to each leg:

$$\text{Leg\#1: } \sum F_{\text{down}} - \int a_{\text{rel}} dm = (p_a - p_1)A + \rho g A h_1 - m_1 \frac{dV}{dt} = 0$$

$$\text{Leg\#2: } \sum F_{\text{up}} - \int a_{\text{rel}} dm = (p_1 - p_a)A - \rho g A h_2 - m_2 \frac{dV}{dt} = 0$$

Add these together. The pressure terms will cancel. Substitute for the  $h$ 's as follows:

$$\rho g A (h_1 - h_2) = \rho g A (2Z) = (m_1 + m_2) \frac{dV}{dt} = \rho A (h_1 + h_2) \frac{dV}{dt} = \rho A L \frac{dV}{dt}$$

$$\text{Since } V = -\frac{dZ}{dt}, \text{ we arrive at, finally, } \frac{d^2 Z}{dt^2} + \frac{2g}{L} Z = 0 \quad \text{Ans.}$$

The solution is a simple harmonic oscillation:  $Z = C \cos \left[ t \sqrt{(2g/L)} \right] + D \sin \left[ t \sqrt{(2g/L)} \right]$ .

**3.97** Extend Prob. 3.96 to include a linear (laminar) average wall shear stress resistance of the form  $\tau \approx 8\mu V/D$ , where  $\mu$  is the fluid viscosity. Find the differential equation for  $dV/dt$  and then solve for  $V(t)$ , assuming an initial displacement  $z = z_o$ ,  $V = 0$  at  $t = 0$ . The result should be a damped oscillation tending toward  $z = 0$ .

**Solution:** The derivation now includes wall shear stress on each leg (see Prob. 3.96):

$$\text{Leg\#1: } \sum F_{\text{down}} - \int a_{\text{rel}} dm = \Delta p A + \rho g A h_1 - \tau_w \pi D h_1 - m_1 \frac{dV}{dt} = 0$$

$$\text{Leg\#2: } \sum F_{\text{up}} - \int a_{\text{rel}} dm = -\Delta p A - \rho g A h_2 - \tau_w \pi D h_2 - m_2 \frac{dV}{dt} = 0$$

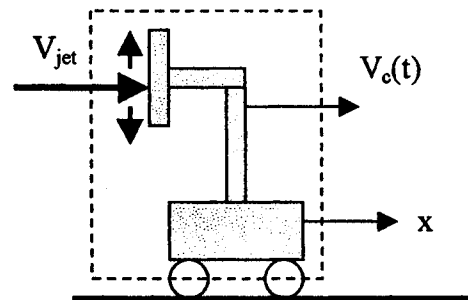
Again add these two together: the pressure terms cancel, and we obtain, if  $A = \pi D^2/4$ ,

$$\frac{d^2 Z}{dt^2} + \frac{4\tau_w}{\rho D} + \frac{2g}{L} Z = 0, \quad \text{where } \tau_w = \frac{8\mu V}{D} \quad \text{Ans.}$$

The shear term is equal to the linear damping term  $(32\mu/\rho D^2)(dZ/dt)$ . If we assume an initial static displacement  $Z = Z_0$ ,  $V = 0$ , at  $t = 0$ , we obtain the damped oscillation

$$Z = Z_0 e^{-t/t^*} \cos(\omega t), \quad \text{where } t^* = \frac{\rho D^2}{16\mu} \quad \text{and } \omega = \sqrt{2g/L} \quad \text{Ans.}$$

**3.98** As an extension of Ex. 3.10, let the plate and cart be unrestrained, with frictionless wheels. Derive (a) the equation of motion for cart velocity  $V_c(t)$ ; and (b) the time required for the cart to accelerate to 90% of jet velocity. (c) Compute numerical values for (b) using the data from Ex. 3.10 and a cart mass of 2 kg.



**Solution:** (a) Use Eq. (3.49) with  $\mathbf{a}_{\text{rel}}$  equal to the cart acceleration and  $\sum F_x = 0$ :

$$\sum F_x - \dot{m}_{x,\text{rel}} = \int u \rho \mathbf{V} \cdot \mathbf{n} dA = -m_c \frac{dV_c}{dt} = -\rho_j A_j (V_j - V_c)^2 \quad \text{Ans. (a)}$$

The above 1<sup>st</sup>-order differential equation can be solved by separating the variables:

$$\int_0^{V_c} \frac{dV_c}{(V_j - V_c)^2} = K \int_0^t dt, \quad \text{where } K = \frac{\rho A_j}{m_c}$$

$$\text{Solve for: } \frac{V_c}{V_j} = \frac{V_j K t}{1 + V_j K t} = 0.90 \quad \text{if } t_{90\%} = \frac{9}{K V_j} = \frac{9 m_c}{\rho A_j V_j} \quad \text{Ans. (b)}$$

$$\text{For the Example 3.10 data, } t_{90\%} = \frac{9(2 \text{ kg})}{(1000 \text{ kg/m}^3)(0.0003 \text{ m}^2)(20 \text{ m/s})} \approx 3.0 \text{ s} \quad \text{Ans. (c)}$$

**3.99** Let the rocket of Fig. E3.12 start at  $z = 0$ , with constant exit velocity and exit mass flow, and rise vertically with zero drag. (a) Show that, as long as fuel burning continues, the vertical height  $S(t)$  reached is given by

$$S = \frac{V_e M_o}{\dot{m}} [\zeta \ln \zeta - \zeta + 1], \quad \text{where } \zeta = 1 - \frac{\dot{m}t}{M_o}$$

(b) Apply this to the case  $V_e = 1500$  m/s and  $M_o = 1000$  kg to find the height reached after a burn of 30 seconds, when the final rocket mass is 400 kg.

**Solution:** (a) Ignoring gravity effects, integrate the equation of the projectile's velocity (from E3.12):

$$S(t) = \int V(t) dt = \int_0^t \left[ -V_e \ln \left( 1 - \frac{\dot{m}t}{M_o} \right) \right] dt$$

Let  $\zeta = 1 - \frac{\dot{m}t}{M_o}$ , then  $d\zeta = -\frac{\dot{m}}{M_o} dt$  and the integral becomes,

$$S(t) = (-V_e) \left[ \frac{-M_o}{\dot{m}} \right] \int_1^\zeta (\zeta \ln \zeta) d\zeta = \left( \frac{V_e M_o}{\dot{m}} \right) [\zeta \ln \zeta - \zeta]_1^\zeta = \left( \frac{V_e M_o}{\dot{m}} \right) [\zeta \ln \zeta - \zeta + 1]$$

(b) Substituting the numerical values given,

$$\dot{m} = \frac{\Delta M}{\Delta t} = \frac{M_f - M_o}{\Delta t} = \frac{1000 \text{ kg} - 400 \text{ kg}}{30 \text{ s}} = 20 \text{ kg/s} \quad \text{and} \quad \zeta = 1 - \frac{(20 \text{ kg/s})(30 \text{ s})}{1000 \text{ kg}} = 0.40$$

$$S(t = 30 \text{ s}) = \frac{(1500 \text{ m/s})(1000 \text{ kg})}{(20 \text{ kg/s})} [0.4 \ln(0.4) - (0.4) + 1] = \mathbf{17,500 \text{ m}} \quad \text{Ans.}$$

**3.100** Suppose that the solid-propellant rocket of Prob. 3.35 is built into a missile of diameter 70 cm and length 4 m. The system weighs 1800 N, which includes 700 N of propellant. Neglect air drag. If the missile is fired vertically from rest at sea level, estimate (a) its velocity and height at fuel burnout and (b) the maximum height it will attain.

**Solution:** The theory of Example 3.12 holds until burnout. Now  $M_o = 1800/9.81 = 183.5$  kg, and recall from Prob. 3.35 that  $V_e = 1150$  m/s and the exit mass flow is 11.8 kg/s. The fuel mass is  $700/9.81 = 71.4$  kg, so burnout will occur at  $t_{\text{burnout}} = 71.4/11.8 = 6.05$  s. Then Example 3.12 predicts the velocity at burnout:

$$V_b = -1150 \ln \left( 1 - \frac{11.8(6.05)}{183.5} \right) - 9.81(6.05) \approx \mathbf{507 \frac{m}{s}} \quad \text{Ans. (a)}$$



Meanwhile, Prob. 3.99 gives the formula for altitude reached at burnout:

$$S_b = \frac{183.5(1150)}{11.8} [1 + (0.611)\{\ln(0.611) - 1\}] - \frac{1}{2}(9.81)(0.605)^2 \approx \mathbf{1393 \text{ m}} \quad \text{Ans. (a)}$$

where “0.611” =  $1 - 11.8(6.05)/183.5$ , that is, the mass ratio at burnout. After burnout, with drag neglected, the missile moves as a falling body. Maximum height occurs at

$$\Delta t = \frac{V_o}{g} = \frac{507}{9.81} = 51.7 \text{ s, whence}$$

$$S = S_o + \frac{1}{2}g\Delta t^2 = 1393 + (1/2)(9.81)(51.7)^2 \approx \mathbf{14500 \text{ m}} \quad \text{Ans. (b)}$$

**3.101** Modify Prob. 3.100 by accounting for air drag on the missile  $F \approx C\rho D^2 V^2$ , where  $C \approx 0.02$ ,  $\rho$  is the air density,  $D$  is the missile diameter, and  $V$  is the missile velocity. Solve numerically for (a) the velocity and altitude at burnout and (b) the maximum altitude attained.

**Solution:** The CV vertical-momentum analysis of Prob. 3.100 is modified to include a drag force resisting the upward acceleration:

$$m \frac{dV}{dt} = \dot{m}V_e - mg - C_D \rho D^2 V^2, \quad \text{where } m = m_o - \dot{m}t, \quad \text{and } \rho = \rho_o \left( \frac{T_o - Bz}{T_o} \right)^{4.26}$$

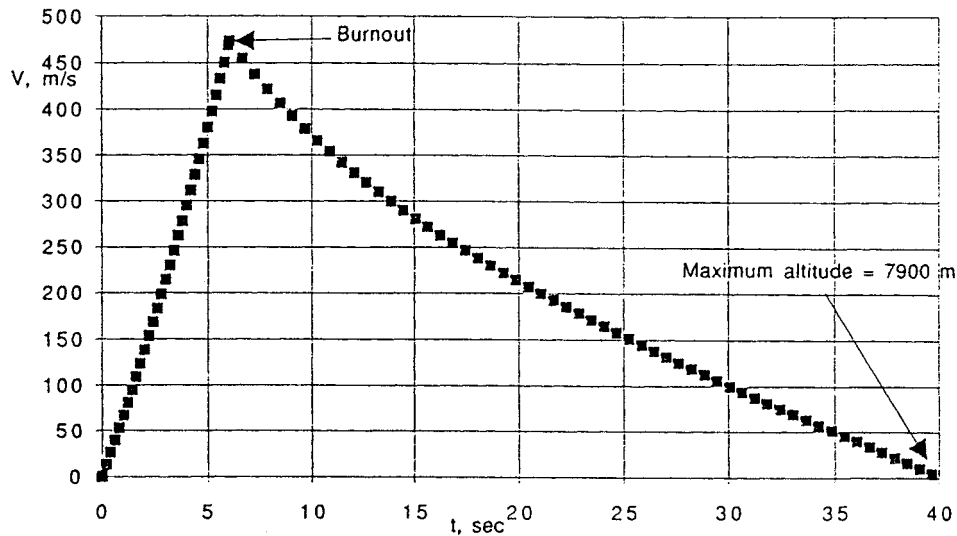
with numerical values  $m_o = 183.5 \text{ kg}$ ,  $\dot{m} = 11.8 \frac{\text{kg}}{\text{s}}$ ,  $V_e = 1150 \frac{\text{m}}{\text{s}}$ ,  $D = 0.7 \text{ m}$ ,  $C_D = 0.02$

We may integrate this numerically, by Runge-Kutta or a spreadsheet or whatever, starting with  $V = 0$ ,  $z = 0$ , at  $t = 0$ . After burnout,  $t \approx 6.05 \text{ s}$ , we drop the thrust term. The density is computed for the U.S. Standard Atmosphere from Table A-6. The writer’s numerical solution is shown graphically on the next page. The particular values asked for in the problem are as follows:

$$\text{At burnout, } t = 6.05 \text{ s: } \mathbf{V \approx 470 \text{ m/s, } z \approx 1370 \text{ m}} \quad \text{Ans. (a)}$$

$$\text{At maximum altitude: } \mathbf{t \approx 40 \text{ s, } z_{\max} \approx 8000 \text{ m}} \quad \text{Ans. (b)}$$

We see that drag has a small effect during rocket thrust but a large effect afterwards.



Problem 3.101 – NUMERICAL SOLUTION

**3.102** As can often be seen in a kitchen sink when the faucet is running, a high-speed channel flow ( $V_1, h_1$ ) may “jump” to a low-speed, low-energy condition ( $V_2, h_2$ ) as in Fig. P3.102. The pressure at sections 1 and 2 is approximately hydrostatic, and wall friction is negligible. Use the continuity and momentum relations to find  $h_2$  and  $V_2$  in terms of ( $h_1, V_1$ ).

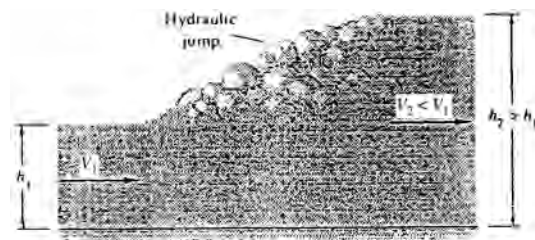


Fig. P3.102

**Solution:** The CV cuts through sections 1 and 2 and surrounds the jump, as shown. Wall shear is neglected. There are no obstacles. The only forces are due to hydrostatic pressure:

$$\sum F_x = 0 = \frac{1}{2} \rho g h_1 (h_1 b) - \frac{1}{2} \rho g h_2 (h_2 b) = \dot{m}(V_2 - V_1),$$

$$\text{where } \dot{m} = \rho V_1 h_1 b = \rho V_2 h_2 b$$

$$\text{Solve for } V_2 = V_1 h_1 / h_2 \quad \text{and} \quad h_2 / h_1 = -\frac{1}{2} + \frac{1}{2} \sqrt{1 + 8V_1^2 / (gh_1)} \quad \text{Ans.}$$

**3.103** Suppose that the solid-propellant rocket of Prob. 3.35 is mounted on a 1000-kg car to propel it up a long slope of  $15^\circ$ . The rocket motor weighs 900 N, which includes 500 N of propellant. If the car starts from rest when the rocket is fired, and if air drag and wheel friction are neglected, estimate the maximum distance that the car will travel up the hill.

**Solution:** This is a variation of Prob. 3.100, except that “g” is now replaced by “g sin  $\theta$ .” Recall from Prob. 3.35 that the rocket mass flow is 11.8 kg/s and its exit velocity is 1150 m/s. The rocket fires for  $t_b = (500/9.81)/11.8 = 4.32$  sec, and the initial mass is  $M_o = (1000 + 900/9.81) = 1092$  kg. Then the differential equation for uphill powered motion is

$$m \frac{dV}{dt} = \dot{m} V_e - mg \sin \theta, \quad m = M_o - \dot{m} t$$

This integrates to:  $V(t) = -V_e \ln(1 - \dot{m} t / M_o) - gt \sin \theta$  for  $t \leq 4.32$  s.

After burnout, the rocket coasts uphill with the usual falling-body formulas with “g sin  $\theta$ .” The distance travelled during rocket power is modified from Prob. 3.99:

$$S = (M_o V_e / \dot{m}) [1 + (1 - \dot{m} t / M_o) \{ \ln(1 - \dot{m} t / M_o) - 1 \}] - \frac{1}{2} g t^2 \sin \theta$$

Apply these to the given data at burnout to obtain

$$V_{\text{burnout}} = -1150 \ln(0.9533) - \frac{1}{2} (9.81) \sin 15^\circ (4.32)^2 \approx 44.0 \text{ m/s}$$

$$S_{\text{burnout}} = \frac{1092(1150)}{11.8} [1 + 0.9533 \{ \ln(0.9533) - 1 \}] - \frac{1}{2} (9.81) \sin 15^\circ (4.32)^2 \approx 94 \text{ m}$$

The rocket then coasts uphill a distance  $\Delta S$  such that  $V_b^2 = 2g\Delta S \sin \theta$ , or  $\Delta S = (44.0)^2 / [2(9.81) \sin 15^\circ] \approx 381$  m. The total distance travelled is  $381 + 94 \approx \mathbf{475 \text{ m}}$  Ans.

**3.104** A rocket is attached to a rigid horizontal rod hinged at the origin as in Fig. P3.104. Its initial mass is  $M_o$ , and its exit properties are  $\dot{m}$  and  $V_e$  relative to the rocket. Set up the differential equation for rocket motion, and solve for the angular velocity  $\omega(t)$  of the rod. Neglect gravity, air drag, and the rod mass.

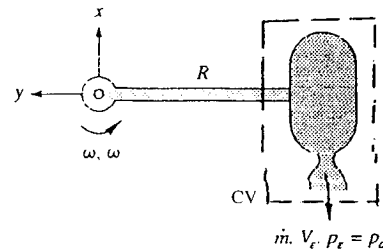


Fig. P3.104

**Solution:** The CV encloses the rocket and moves at (accelerating) rocket speed  $\Omega(t)$ . The rocket arm is free to rotate, there is no force parallel to the rocket motion. Then we have

$$\Sigma F_{\text{tangent}} = 0 - \int a_{\text{rel}} dm = \dot{m}(-V_e), \quad \text{or} \quad mR \frac{d\Omega}{dt} = \dot{m}V_e, \quad \text{where } m = M_o - \dot{m}t$$

$$\text{Integrate, with } \Omega = 0 \text{ at } t = 0, \text{ to obtain } \Omega = -\frac{V_e}{R} \ln\left(1 - \frac{\dot{m}t}{M_o}\right) \quad \text{Ans.}$$

**3.105** Extend Prob. 3.104 to the case where the rocket has a linear air drag force  $F = cV$ , where  $c$  is a constant. Assuming no burnout, solve for  $\alpha(t)$  and find the *terminal* angular velocity, i.e., the final motion when the angular acceleration is zero. Apply to the case  $M_o = 6$  kg,  $R = 3$  m,  $m = 0.05$  kg/s,  $V_e = 1100$  m/s, and  $c = 0.075$  N·s/m to find the angular velocity after 12 s of burning.

**Solution:** If linear resistive drag is added to Prob. 3.104, the equation of motion becomes

$$m \frac{d\Omega}{dt} = \frac{\dot{m}V_e}{R} - C\Omega, \quad \text{where } m = M_o - \dot{m}t, \text{ with } \Omega = 0 \text{ at } t = 0$$

The solution is found by separation of variables:

$$\text{If } B = \dot{m}V_e/R, \text{ then } \int_0^{\Omega} \frac{d\Omega}{B - C\Omega} = \int_0^t \frac{dt}{M_o - \dot{m}t}, \quad \text{or: } \Omega = \frac{B}{C} \left[ 1 - \left( 1 - \frac{\dot{m}t}{M_o} \right)^{C/\dot{m}} \right] \quad \text{Ans. (a)}$$

Strictly speaking, there is no terminal velocity, but if we set the acceleration equal to zero in the basic differential equation, we obtain an estimate  $\Omega_{\text{term}} = mV_e/(RC)$ . *Ans. (b)*

For the given data, at  $t = 12$  s, we obtain the angular velocity

$$\text{At } t = 12 \text{ s: } \Omega = \frac{(0.05)(1100)}{(3.0)(0.075)} \left[ 1 - \left( 1 - \frac{0.05(12)}{6.0} \right)^{\frac{0.075}{0.05}} \right] \approx 36 \frac{\text{rad}}{\text{sec}} \quad \text{Ans. (c)}$$

**3.106** Extend Prob. 3.104 to the case where the rocket has a quadratic air drag force  $F = kV^2$ , where  $k$  is a constant. Assuming no burnout, solve for  $\alpha(t)$  and find the *terminal* angular velocity, i.e., the final motion when the angular acceleration is zero. Apply to the case  $M_o = 6$  kg,  $R = 3$  m,  $m = 0.05$  kg/s,  $V_e = 1100$  m/s, and  $k = 0.0011$  N·s<sup>2</sup>/m<sup>2</sup> to find the angular velocity after 12 s of burning.

**Solution:** If quadratic drag is added to Prob. 3.104, the equation of motion becomes

$$m \frac{d\Omega}{dt} = \frac{\dot{m}V_e}{R} - kR\Omega^2, \quad \text{where } m = M_o - \dot{m}t, \text{ with } \Omega = 0 \text{ at } t = 0$$

The writer has not solved this equation analytically, although it is possible. A numerical solution results in the following results for this particular data ( $V_e = 1100$  m/s, etc.):

t, sec:	0	3	6	9	12	15	20	30	40	50	60	70
$\Omega$ , rad/s:	0	9.2	18.4	27.3	35.6	43.1	53.5	66.7	72.0	73.9	74.4	74.5

The answer desired,  $\Omega \approx 36$  rad/s at  $t = 12$  s, is coincidentally the same as Prob. 3.105.

Note that, in this case, the quadratic drag, being stronger at high  $\Omega$ , causes the rocket to approach terminal speed before the fuel runs out (assuming it has that much fuel):

$$\text{Terminal speed, } \frac{d\Omega}{dt} = 0: \quad \Omega_{\text{final}} = \sqrt{\frac{\dot{m}V_e}{kR^2}} = \sqrt{\frac{0.05(1100)}{0.0011(3)^2}} = 74.5 \frac{\text{rad}}{\text{s}} \quad \text{Ans.}$$

**3.107** The cart in Fig. P3.107 moves at constant velocity  $V_o = 12$  m/s and takes on water with a scoop 80 cm wide which dips  $h = 2.5$  cm into a pond. Neglect air drag and wheel friction. Estimate the force required to keep the cart moving.

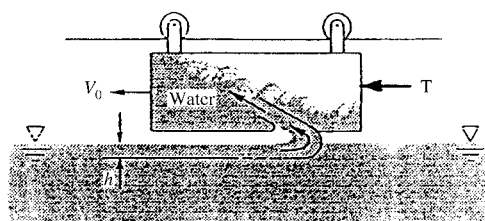


Fig. P3.107

**Solution:** The CV surrounds the cart and scoop and moves to the left at cart speed  $V_o$ . Momentum *within* the cart fluid is neglected. The horizontal force balance is

$$\sum F_x = -\text{Thrust} = -\dot{m}_{\text{scoop}} V_{\text{inlet}}, \quad \text{but } V_{\text{inlet}} = V_o \text{ (water motion relative to scoop)}$$

$$\text{Therefore } \text{Thrust} = \dot{m}V_o = [998(0.025)(0.8)(12)](12) \approx \mathbf{2900 \text{ N}} \quad \text{Ans.}$$

**3.108** A rocket sled of mass  $M$  is to be decelerated by a scoop, as in Fig. P3.108, which has width  $b$  into the paper and dips into the water a depth  $h$ , creating an upward jet at  $60^\circ$ . The rocket thrust is  $T$  to the left. Let the initial velocity be  $V_o$ , and neglect air drag and wheel friction. Find an expression for  $V(t)$  of the sled for (a)  $T = 0$  and (b) finite  $T \neq 0$ .

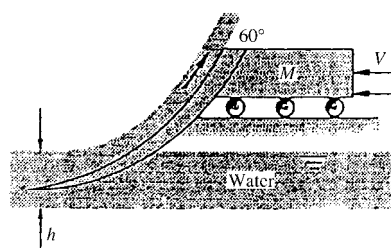


Fig. P3.108

**Solution:** The CV surrounds the sled and scoop and moves to the *left* at sled speed  $V(t)$ . Let  $x$  be positive to the left. The horizontal force balance is

$$\sum F_x = T - M \frac{dV}{dt} = \dot{m}_{\text{out}} u_{\text{out}} - \dot{m}_{\text{in}} u_{\text{in}} = \dot{m}(-V \cos \theta) - \dot{m}(-V), \quad \dot{m} = \rho b h V$$

$$\text{or: } M_{\text{sled}} \frac{dV}{dt} = T - CV^2, \quad C = \rho b h (1 - \cos \theta)$$

Whether or not thrust  $T = 0$ , the variables can be separated and integrated:

$$(a) T = 0: \int_{V_0}^V \frac{dV}{V^2} = -\frac{C}{M} \int_0^t dt, \quad \text{or: } V = \frac{V_0}{1 + CV_0 t/M} \quad \text{Ans. (a)}$$

$$(b) T > 0: \int_{V_0}^V \frac{M dV}{T - CV^2} = \int_0^t dt, \quad \text{or: } V = V_{\text{final}} \tanh[\alpha t + \phi] \quad \text{Ans. (b)}$$

where  $V_{\text{final}} = [T/\rho b h (1 - \cos \theta)]^{1/2}$ ,  $\alpha = [T \rho b h (1 - \cos \theta)]^{1/2}/M$ ,  $\phi = \tanh^{-1}(V_0/V_f)$

This solution only applies when  $V_0 < V_{\text{final}}$ , which may not be the case for a speedy sled.

**3.109** Apply Prob. 3.108 to the following data:  $M_0 = 900$  kg,  $b = 60$  cm,  $h = 2$  cm,  $V_0 = 120$  m/s, with the rocket of Prob. 3.35 attached and burning. Estimate  $V$  after 3 sec.

**Solution:** Recall from Prob. 3.35 that the rocket had a thrust of 13600 N and an exit mass flow of 11.8 kg/s. Then, after 3 s, the mass has only dropped to  $900 - 11.8(3) = 865$  kg, so we can approximate that, over 3 seconds, the sled mass is near constant at about 882 kg. Compute the “final” velocity if the rocket keeps burning:

$$V_{\text{final}} = [T/(\rho b h (1 - \cos \theta))]^{1/2} = \left[ \frac{13600}{998(0.6)(0.02)(1 - \cos 60^\circ)} \right]^{1/2} \approx 47.66 \frac{\text{m}}{\text{s}}$$

Thus solution (b) to Prob. 3.108 does not apply, since  $V_0 = 120$  m/s  $>$   $V_{\text{final}}$ . We therefore effect a numerical solution of the basic differential equation from Prob. 3.108:

$$M \frac{dV}{dt} = T - \rho b h (1 - \cos \theta) V^2, \quad \text{or: } 882 \frac{dV}{dt} = 13600 - 5.988 V^2, \quad \text{with } V_0 = 120 \frac{\text{m}}{\text{s}}$$

The writer solved this on a spreadsheet for  $0 < t < 3$  sec. The results may be tabulated:

t, sec:	0.0	0.5	1.0	1.5	2.0	2.5	<b>3.0 sec</b>
V, m/s:	120.0	90.9	75.5	66.3	60.4	56.6	<b><u>53.9 m/s</u></b>

The sled has decelerated to 53.9 m/s, quite near its “steady” speed of about 46 m/s.

**3.110** The horizontal lawn sprinkler in Fig. P3.110 has a water flow rate of 4.0 gal/min introduced vertically through the center. Estimate (a) the retarding torque required to keep the arms from rotating and (b) the rotation rate (r/min) if there is no retarding torque.

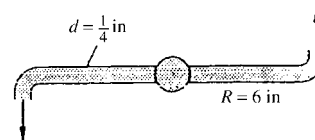


Fig. P3.110

**Solution:** The flow rate is 4 gal/min = 0.008912 ft<sup>3</sup>/s, and  $\rho = 1.94$  slug/ft<sup>3</sup>. The velocity issuing from each arm is  $V_o = (0.008912/2)/[(\pi/4)(0.25/12 \text{ ft})^2] \approx 13.1$  ft/s. Then:

(a) From Example 3.15,  $\omega = \frac{V_o}{R} - \frac{T_o}{\rho QR^2}$  and, if there is no motion ( $\omega = 0$ ),

$$T_o = \rho QR V_o = (1.94)(0.008912)(6/12)(13.1) \approx \mathbf{0.113 \text{ ft}\cdot\text{lbf}} \quad \text{Ans. (a)}$$

(b) If  $T_o = 0$ , then  $\omega_{\text{no friction}} = V_o/R = \frac{13.1 \text{ ft/s}}{6/12 \text{ ft}} = 26.14 \frac{\text{rad}}{\text{s}} \approx \mathbf{250 \frac{\text{rev}}{\text{min}}}$  Ans. (b)

**3.111** In Prob. 3.60 find the torque caused around flange 1 if the center point of exit 2 is 1.2 m directly below the flange center.

**Solution:** The CV encloses the elbow and cuts through flange (1). Recall from Prob. 3.60 that  $D_1 = 10$  cm,  $D_2 = 3$  cm, weight flow = 150 N/s, whence  $V_1 = 1.95$  m/s and  $V_2 = 21.7$  m/s. Let “O” be in the center of flange (1). Then  $\mathbf{r}_{O2} = -1.2\mathbf{j}$  and  $\mathbf{r}_{O1} = \mathbf{0}$ .

The pressure at (1) passes through O, thus causes no torque. The moment relation is

$$\sum \mathbf{M}_O = \mathbf{T}_O = \dot{m}[(\mathbf{r}_{O2} \times \mathbf{V}_2) - (\mathbf{r}_{O1} \times \mathbf{V}_1)] = \left( \frac{150}{9.81} \frac{\text{kg}}{\text{s}} \right) [(-1.2\mathbf{j}) \times (-16.6\mathbf{i} - 13.9\mathbf{j})]$$

$$\text{or: } \mathbf{T}_O = -305 \mathbf{k} \text{ N}\cdot\text{m} \quad \text{Ans.}$$

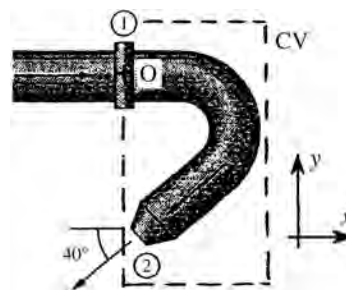


Fig. P3.60

**3.112** The wye joint in Fig. P3.112 splits the pipe flow into equal amounts  $Q/2$ , which exit, as shown, a distance  $R_o$  from the axis. Neglect gravity and friction. Find an expression for the torque  $T$  about the  $x$  axis required to keep the system rotating at angular velocity  $\Omega$ .

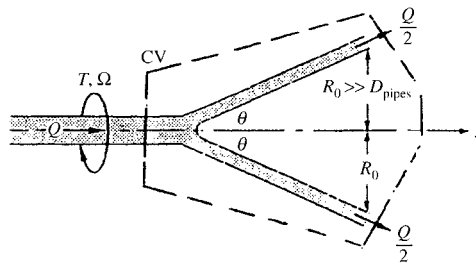


Fig. P3.112

**Solution:** Let the CV enclose the junction, cutting through the inlet pipe and thus exposing the required torque  $T$ . If  $y$  is “up” in the figure, the absolute exit velocities are

$$\mathbf{V}_{\text{upper}} = V_o \cos \theta \mathbf{i} + V_o \sin \theta \mathbf{j} + R_o \Omega \mathbf{k}; \quad \mathbf{V}_{\text{lower}} = V_o \cos \theta \mathbf{i} - V_o \sin \theta \mathbf{j} - R_o \Omega \mathbf{k}$$

where  $V_o = Q/(2A)$  is the exit velocity relative to the pipe walls. Then the moments about the  $x$  axis are related to angular momentum fluxes by

$$\begin{aligned} \sum \mathbf{M}_{\text{axis}} = T \mathbf{i} &= (\rho Q/2)(R_o \mathbf{j}) \times \mathbf{V}_{\text{upper}} + (\rho Q/2)(-R_o \mathbf{j}) \times \mathbf{V}_{\text{lower}} - \rho Q(\mathbf{r}_{\text{inlet}} \mathbf{V}_{\text{inlet}}) \\ &= \frac{\rho Q}{2} (R_o^2 \Omega \mathbf{i} - R_o V_o \Omega \mathbf{k}) + \frac{\rho Q}{2} (R_o^2 \Omega \mathbf{i} + R_o V_o \Omega \mathbf{k}) - \rho Q(0) \end{aligned}$$

Each arm contributes to the torque via relative velocity ( $\Omega R_o$ ). Other terms with  $V_o$  cancel.

$$\text{Final torque result: } T = \rho Q R_o^2 \Omega = \dot{m} R_o^2 \Omega \quad \text{Ans.}$$

**3.113** Modify Ex. 3.15 so that the arm starts up from rest and spins up to its final rotation speed. The moment of inertia of the arm about  $O$  is  $I_o$ . Neglect air drag. Find  $d\omega/dt$  and integrate to determine  $\omega(t)$ , assuming  $\omega = 0$  at  $t = 0$ .

**Solution:** The CV is shown. Apply clockwise moments:

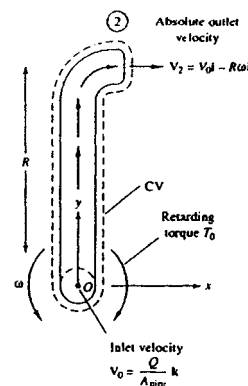
$$\sum \mathbf{M}_o - \int (\mathbf{r} \times \mathbf{a}_{\text{rel}}) dm = \int_{\text{CS}} (\mathbf{r} \times \mathbf{V}) dm,$$

$$\text{or: } -T_o - I_o \frac{d\omega}{dt} = \rho Q (R^2 \omega - R V_o),$$

$$\text{or: } \frac{d\omega}{dt} + \frac{\rho Q R^2}{I_o} \omega = \frac{\rho Q R V_o - T_o}{I_o}$$

Integrate this first-order linear differential equation, with  $\omega = 0$  at  $t = 0$ . The result is:

$$\omega = \left( \frac{V_o}{R} - \frac{T_o}{\rho Q R^2} \right) \left[ 1 - e^{-\rho Q R^2 t / I_o} \right] \quad \text{Ans.}$$



**Fig. 3.14** View from above of a single arm of a rotating lawn sprinkler.



**3.114** The 3-arm lawn sprinkler of Fig. P3.114 receives 20°C water through the center at 2.7 m<sup>3</sup>/hr. If collar friction is neglected, what is the steady rotation rate in rev/min for (a)  $\theta = 0^\circ$ ; (b)  $\theta = 40^\circ$ ?

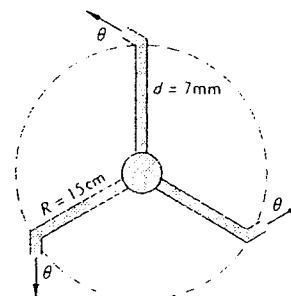


Fig. P3.114

**Solution:** The velocity exiting each arm is

$$V_o = \frac{Q/3}{(\pi/4)d^2} = \frac{2.7/[(3600)(3)]}{(\pi/4)(0.007)^2} = 6.50 \frac{\text{m}}{\text{s}}$$

With negligible air drag and bearing friction, the steady rotation rate (Example 3.15) is

$$\omega_{\text{final}} = \frac{V_o \cos \theta}{R} \quad (\text{a}) \quad \theta = 0^\circ: \quad \omega = \frac{(6.50) \cos 0^\circ}{0.15 \text{ m}} = 43.3 \frac{\text{rad}}{\text{s}} = \mathbf{414 \frac{\text{rev}}{\text{min}}} \quad \text{Ans. (a)}$$

$$(\text{b}) \quad \theta = 40^\circ: \quad \omega = \omega_o \cos \theta = (414) \cos 40^\circ = \mathbf{317 \frac{\text{rev}}{\text{min}}} \quad \text{Ans. (b)}$$

**3.115** Water at 20°C flows at 30 gal/min through the 0.75-in-diameter double pipe bend of Fig. P3.115. The pressures are  $p_1 = 30 \text{ lbf/in}^2$  and  $p_2 = 24 \text{ lbf/in}^2$ . Compute the torque  $T$  at point  $B$  necessary to keep the pipe from rotating.

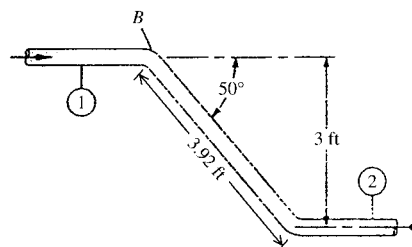


Fig. P3.115

**Solution:** This is similar to Example 3.13, of the text. The volume flow  $Q = 30 \text{ gal/min} = 0.0668 \text{ ft}^3/\text{s}$ , and  $\rho = 1.94 \text{ slug/ft}^3$ . Thus the mass flow  $\rho Q = 0.130 \text{ slug/s}$ . The velocity in the pipe is

$$V_1 = V_2 = Q/A = \frac{0.0668}{(\pi/4)(0.75/12)^2} = 21.8 \frac{\text{ft}}{\text{s}}$$

If we take torques about point  $B$ , then the distance “ $h_1$ ,” from p. 143, = 0, and  $h_2 = 3 \text{ ft}$ . The final torque at point  $B$ , from “Ans. (a)” on p. 143 of the text, is

$$T_B = h_2(p_2 A_2 + \dot{m} V_2) = (3 \text{ ft})[(24 \text{ psi}) \frac{\pi}{4} (0.75 \text{ in})^2 + (0.130)(21.8)] \approx \mathbf{40 \text{ ft} \cdot \text{lbf}} \quad \text{Ans.}$$

**3.116** The centrifugal pump of Fig. P3.116 has a flow rate  $Q$  and exits the impeller at an angle  $\theta_2$  relative to the blades, as shown. The fluid enters axially at section 1. Assuming incompressible flow at shaft angular velocity  $\omega$ , derive a formula for the power  $P$  required to drive the impeller.

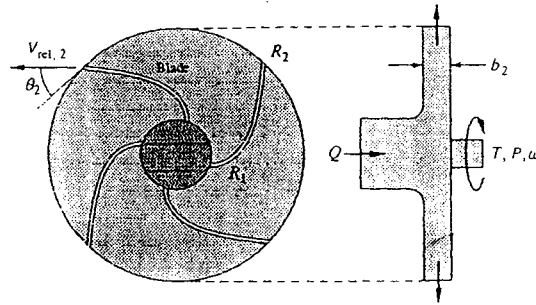
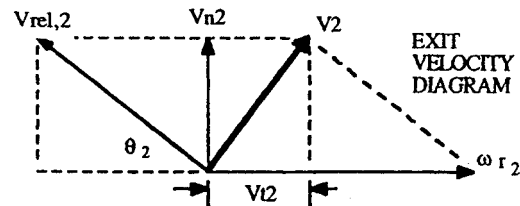


Fig. P3.116



**Solution:** Relative to the blade, the fluid exits at velocity  $V_{rel,2}$  tangent to the blade, as shown in Fig. P3.116. But the Euler turbine formula, Ans. (a) from Example 3.14 of the text,

$$\begin{aligned} \text{Torque } T &= \rho Q(r_2 V_{t2} - r_1 V_{t1}) \\ &\approx \rho Q r_2 V_{t2} \quad (\text{assuming } V_{t1} \approx 0) \end{aligned}$$

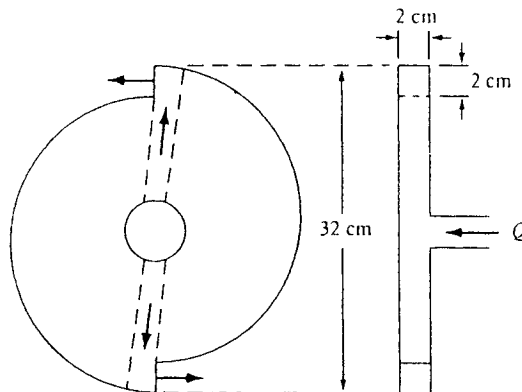
involves the *absolute fluid velocity tangential to the blade circle* (see Fig. 3.13). To derive this velocity we need the “velocity diagram” shown above, where absolute exit velocity  $V_2$  is found by adding blade tip rotation speed  $\omega r_2$  to  $V_{rel,2}$ . With trigonometry,

$$V_{t2} = r_2 \omega - V_{n2} \cot \theta_2, \quad \text{where } V_{n2} = Q/A_{\text{exit}} = \frac{Q}{2\pi r_2 b_2} \text{ is the normal velocity}$$

With torque  $T$  known, the power required is  $P = T\omega$ . The final formula is:

$$P = \rho Q r_2 \omega \left[ r_2 \omega - \left( \frac{Q}{2\pi r_2 b_2} \right) \cot \theta_2 \right] \quad \text{Ans.}$$

**3.117** A simple turbomachine is constructed from a disk with two internal ducts which exit tangentially through square holes, as in the figure. Water at 20°C enters the disk at the center, as shown. The disk must drive, at 250 rev/min, a small device whose retarding torque is 1.5 N·m. What is the proper mass flow of water, in kg/s?



**Solution:** This problem is a disguised version of the lawn-sprinkler arm in Example 3.15. For that problem, the steady rotating speed, with retarding torque  $T_o$ , was

$$\omega = \frac{V_o}{R} - \frac{T_o}{\rho Q R^2}, \quad \text{where } V_o \text{ is the exit velocity and } R \text{ is the arm radius.}$$

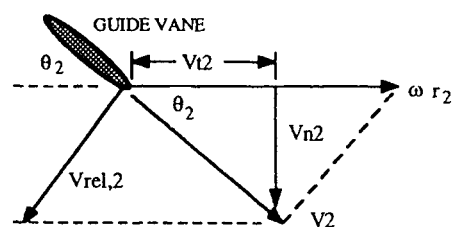
Enter the given data, noting that  $Q = 2V_o \Delta L_{\text{exit}}^2$  is the total volume flow from the two arms:

$$\omega = 250 \left( \frac{2\pi}{60} \right) \frac{\text{rad}}{\text{s}} = \frac{V_o}{0.16 \text{ m}} - \frac{1.5 \text{ N} \cdot \text{m}}{998(2V_o)(0.02 \text{ m})^2(0.16 \text{ m})^2}, \quad \text{solve } V_o = \mathbf{6.11} \frac{\text{m}}{\text{s}}$$

The required mass flow is thus,

$$\dot{m} = \rho Q = \left( 998 \frac{\text{kg}}{\text{m}^3} \right) \left( 2 \left( 6.11 \frac{\text{m}}{\text{s}} \right) \right) (0.02 \text{ m})^2 = \mathbf{2.44} \frac{\text{kg}}{\text{s}} \quad \text{Ans.}$$

**3.118** Reverse the flow in Fig. P3.116, so that the system operates as a radial-inflow turbine. Assuming that the outflow into section 1 has no tangential velocity, derive an expression for the power  $P$  extracted by the turbine.



**Solution:** The Euler turbine formula, “Ans. (a)” from Example 3.14 of the text, is valid in reverse, that is, for a turbine with inflow at section 2 and outflow at section 1. The torque developed is

$$T_o = \rho Q (r_2 V_{t2} - r_1 V_{t1}) \approx \rho Q r_2 V_{t2} \quad \text{if } V_{t1} \approx 0$$

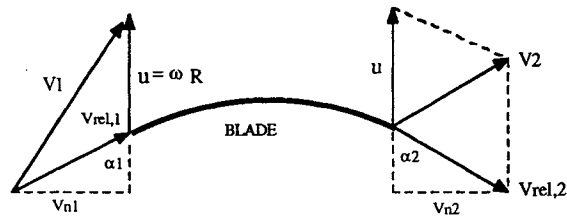
The velocity diagram is reversed, as shown in the figure. The fluid enters the turbine at angle  $\theta_2$ , which can only be ensured by a guide vane set at that angle. The absolute tangential velocity component is directly related to inlet normal velocity, giving the final result

$$V_{t2} = V_{n2} \cot \theta_2, \quad V_{n2} = \frac{Q}{2\pi r_2 b_2},$$

$$\text{thus } P = \omega T_o = \rho Q \omega r_2 \left( \frac{Q}{2\pi r_2 b_2} \right) \cot \theta_2 \quad \text{Ans.}$$

**3.119** Revisit the turbine cascade system of Prob. 3.78, and derive a formula for the power  $P$  delivered, using the *angular-momentum* theorem of Eq. (3.55).

**Solution:** To use the angular momentum theorem, we need the inlet and outlet velocity diagrams, as in the figure. The Euler turbine formula becomes



$$T_o = \rho Q(r_1 V_{t1} - r_2 V_{t2}) \approx \rho QR(V_{t1} - V_{t2})$$

since the blades are at nearly constant radius  $R$ . From the velocity diagrams, we find

$$V_{t1} = u + V_{n1} \cot \alpha_1; \quad V_{t2} = u - V_{n2} \cot \alpha_2, \quad \text{where } V_{n1} = V_{n2} = V_1 \cos \beta_1$$

The normal velocities are equal by virtue of mass conservation across the blades. Finally,

$$P = \rho Q \omega R (V_{t1} - V_{t2}) = \rho Q u V_n (\cot \alpha_1 + \cot \alpha_2) \quad \text{Ans.}$$

**3.120** A centrifugal pump delivers 4000 gal/min of water at 20°C with a shaft rotating at 1750 rpm. Neglect losses. If  $r_1 = 6$  in,  $r_2 = 14$  in,  $b_1 = b_2 = 1.75$  in,  $V_{t1} = 10$  ft/s, and  $V_{t2} = 110$  ft/s, compute the absolute velocities (a)  $V_1$  and (b)  $V_2$ , and (c) the ideal horsepower required.

**Solution:** First convert 4000 gal/min = 8.91 ft<sup>3</sup>/s and 1750 rpm = 183 rad/s. For water, take  $\rho = 1.94$  slug/ft<sup>3</sup>. The normal velocities are determined from mass conservation:

$$V_{n1} = \frac{Q}{2\pi r_1 b_1} = \frac{8.91}{2\pi(6/12)(1.75/12)} = 19.5 \frac{\text{ft}}{\text{s}}; \quad V_{n2} = \frac{Q}{2\pi r_2 b_2} = 8.34 \frac{\text{ft}}{\text{s}}$$

Then the desired absolute velocities are simply the resultants of  $V_t$  and  $V_n$ :

$$V_1 = [(10)^2 + (19.45)^2]^{1/2} = \mathbf{22 \frac{ft}{s}} \quad V_2 = [(110)^2 + (8.3)^2]^{1/2} = \mathbf{110 \frac{ft}{s}} \quad \text{Ans. (a, b)}$$

The ideal power required is given by Euler's formula:

$$\begin{aligned} P &= \rho Q \omega (r_2 V_{t2} - r_1 V_{t1}) = (1.94)(8.91)(183)[(14/12)(110) - (6/12)(10)] \\ &= 391,000 \frac{\text{ft-lbf}}{\text{s}} \approx \mathbf{710 \text{ hp}} \quad \text{Ans. (c)} \end{aligned}$$

**3.121** The pipe bend of Fig. P3.121 has  $D_1 = 27$  cm and  $D_2 = 13$  cm. When water at  $20^\circ\text{C}$  flows through the pipe at 4000 gal/min,  $p_1 = 194$  kPa (gage). Compute the torque required at point  $B$  to hold the bend stationary.

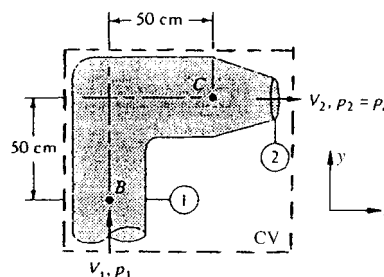


Fig. P3.121

**Solution:** First convert  $Q = 4000$  gal/min  $= 0.252$  m<sup>3</sup>/s. We need the exit velocity:

$$V_2 = Q/A_2 = \frac{0.252}{(\pi/4)(0.13)^2} = 19.0 \frac{\text{m}}{\text{s}} \quad \text{Meanwhile, } V_1 = Q/A_1 = 4.4 \frac{\text{m}}{\text{s}}$$

We don't really need  $V_1$ , because it passes through  $B$  and has no angular momentum. The angular momentum theorem is then applied to point  $B$ :

$$\sum \mathbf{M}_B = \mathbf{T}_B + \mathbf{r}_1 \times p_1 A_1 \mathbf{j} + \mathbf{r}_2 \times p_2 A_2 (-\mathbf{i}) = \dot{m}(\mathbf{r}_2 \times \mathbf{V}_2 - \mathbf{r}_1 \times \mathbf{V}_1)$$

But  $\mathbf{r}_1$  and  $p_2$  are zero,

$$\text{hence } \mathbf{T}_B = \dot{m}(\mathbf{r}_2 \times \mathbf{V}_2) = \rho Q[(0.5\mathbf{i} + 0.5\mathbf{j}) \times (19.0\mathbf{i})]$$

Thus, finally,  $\mathbf{T}_B = (998)(0.252)(0.5)(19.0)(-\mathbf{k}) \approx -2400 \text{ k N}\cdot\text{m}$  (clockwise) *Ans.*

**3.122** Extend Prob. 3.46 to the problem of computing the center of pressure  $L$  of the normal face  $F_n$ , as in Fig. P3.122. (At the center of pressure, no moments are required to hold the plate at rest.) Neglect friction. Express your result in terms of the sheet thickness  $h_1$  and the angle  $\theta$  between the plate and the oncoming jet 1.

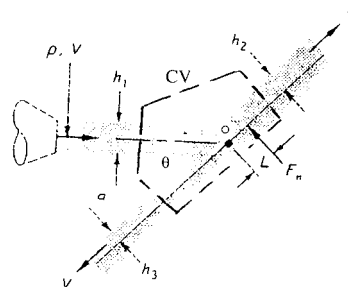


Fig. P3.122

**Solution:** Recall that in Prob. 3.46 of this Manual, we found  $h_2 = (h_1/2)(1 + \cos\theta)$  and that  $h_3 = (h_1/2)(1 - \cos\theta)$ . The force on the plate was  $F_n = \rho QV \sin\theta$ . Take clockwise moments about  $O$  and use the angular momentum theorem:

$$\begin{aligned} \sum M_o &= -F_n L = \dot{m}_2 |\mathbf{r}_{2o} \times \mathbf{V}_2|_z + \dot{m}_3 |\mathbf{r}_{3o} \times \mathbf{V}_3|_z - \dot{m}_1 |\mathbf{r}_{1o} \times \mathbf{V}_1|_z \\ &= \rho V h_2 (h_2 V/2) + \rho V h_3 (-h_3 V/2) - 0 = (1/2) \rho V^2 (h_2^2 - h_3^2) \end{aligned}$$

$$\text{Thus } L = -\frac{(1/2)\rho V^2 (h_2^2 - h_3^2)}{\rho V^2 h_1 \sin \theta} = -\frac{(h_2^2 - h_3^2)}{2h_1 \sin \theta} = -\frac{1}{2} h_1 \cot \theta \quad \text{Ans.}$$

The latter result follows from the  $(h_1, h_2, h_3)$  relations in 3.46. The C.P. is below point O.

**3.123** The waterwheel in Fig. P3.123 is being driven at 200 r/min by a 150-ft/s jet of water at 20°C. The jet diameter is 2.5 in. Assuming no losses, what is the horsepower developed by the wheel? For what speed  $\Omega$  r/min will the horsepower developed be a maximum? Assume that there are many buckets on the waterwheel.

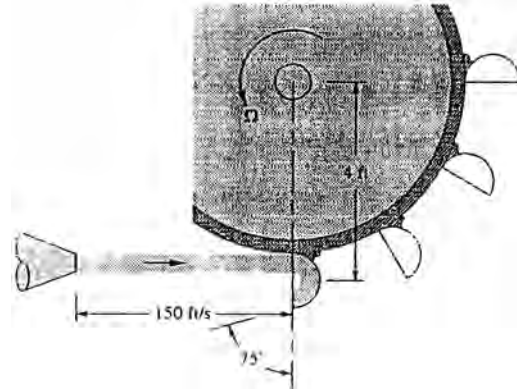


Fig. P3.123

**Solution:** First convert  $\Omega = 200 \text{ rpm} = 20.9 \text{ rad/s}$ . The bucket velocity  $= V_b = \Omega R = (20.9)(4) = 83.8 \text{ ft/s}$ . From Prob. 3.51 of this Manual, if there are many buckets, the entire (absolute) jet mass flow does the work:

$$\begin{aligned} P &= \dot{m}_{\text{jet}} V_b (V_{\text{jet}} - V_b)(1 - \cos 165^\circ) = \rho A_{\text{jet}} V_{\text{jet}} V_b (V_{\text{jet}} - V_b)(1.966) \\ &= (1.94) \frac{\pi}{4} \left( \frac{2.5}{12} \right)^2 (150)(83.8)(150 - 83.8)(1.966) \\ &= 108200 \frac{\text{ft} \cdot \text{lbf}}{\text{s}} \approx \mathbf{197 \text{ hp}} \quad \text{Ans.} \end{aligned}$$

Prob. 3.51: Max. power is for  $V_b = V_{\text{jet}}/2 = 75 \text{ ft/s}$ , or  $\Omega = 18.75 \text{ rad/s} = \mathbf{179 \text{ rpm}}$  Ans.

**3.124** A rotating dishwasher arm delivers at 60°C to six nozzles, as in Fig. P3.124. The total flow rate is 3.0 gal/min. Each nozzle has a diameter of  $\frac{3}{16}$  in. If the nozzle flows are equal and friction is neglected, estimate the steady rotation rate of the arm, in r/min.

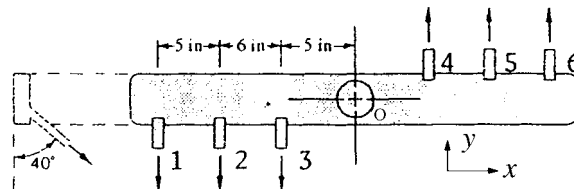


Fig. P3.124

**Solution:** First we need the mass flow and velocity from each hole “i,”  $i = 1$  to 6:

$$V_i = \frac{Q_i}{A_i} = \frac{(3.0/448.8)/6}{(\pi/4)\left(\frac{3/16}{12}\right)^2} \approx 5.81 \frac{\text{ft}}{\text{s}} \quad \dot{m}_i = \frac{\rho Q}{6} = 1.94 \left(\frac{3/448.8}{6}\right) = 0.00216 \frac{\text{slug}}{\text{s}}$$

Recall Example 3.15 from the text. For each hole, we need the absolute velocity,  $V_i - \Omega r_i$ . The angular momentum theorem is then applied to moments about point O:

$$\sum M_O = T_O = \sum \dot{m}_i (\mathbf{r}_{iO} \times \mathbf{V}_{i,\text{abs}}) - \dot{m}_{\text{in}} V_{\text{in}} = \sum \dot{m}_i r_i (V_i \cos 40^\circ - \Omega r_i)$$

All the velocities and mass flows from each hole are equal. Then, if  $T_O = 0$  (no friction),

$$\Omega = \frac{\sum \dot{m}_i r_i V_i \cos 40^\circ}{\sum \dot{m}_i r_i^2} = V_i \cos 40^\circ \frac{\sum r_i}{\sum r_i^2} = (5.81)(0.766) \frac{5.33}{5.58} = 4.25 \frac{\text{rad}}{\text{s}} = \mathbf{41 \text{ rpm}} \quad \text{Ans.}$$

**3.125** A liquid of density  $\rho$  flows through a  $90^\circ$  bend as in Fig. P3.125 and issues vertically from a uniformly porous section of length  $L$ . Neglecting weight, find a result for the support torque  $M$  required at point O.

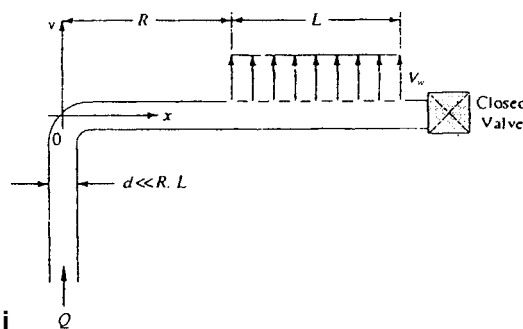


Fig. P3.125

**Solution:** Mass conservation requires

$$Q = \int_0^L V_w (\pi d) dx = V_w \pi d L, \quad \text{or:} \quad \frac{dQ}{dx} = \pi d V_w$$

Then the angular momentum theorem applied to moments about point O yields

$$\begin{aligned} \sum M_O = T_O &= \int_{\text{CS}} (\mathbf{r}_O \times \mathbf{V}) d\dot{m}_{\text{out}} = \mathbf{k} \int_0^L (R+x) V_w \rho \pi d V_w dx \\ &= \frac{\mathbf{k}}{2} \rho \pi d V_w^2 [(R+x)^2 - R^2] \Big|_0^L \end{aligned}$$

Substitute  $V_w \pi d L = Q$  and clean up to obtain  $T_O = \rho Q V_w \left( R + \frac{L}{2} \right) \mathbf{k} \curvearrowright$  Ans.

**3.126** Given is steady isothermal flow of water at 20°C through the device in Fig. P3.126. Heat-transfer, gravity, and temperature effects are negligible. Known data are  $D_1 = 9$  cm,  $Q_1 = 220$  m<sup>3</sup>/h,  $p_1 = 150$  kPa,  $D_2 = 7$  cm,  $Q_2 = 100$  m<sup>3</sup>/h,  $p_2 = 225$  kPa,  $D_3 = 4$  cm, and  $p_3 = 265$  kPa. Compute the rate of shaft work done for this device and its direction.

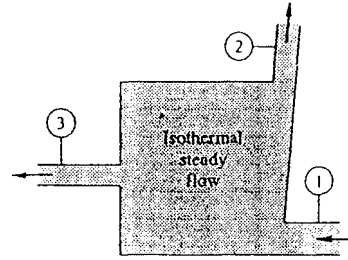


Fig. P3.126

**Solution:** For continuity,  $Q_3 = Q_1 - Q_2 = 120$  m<sup>3</sup>/hr. Establish the velocities at each port:

$$V_1 = \frac{Q_1}{A_1} = \frac{220/3600}{\pi(0.045)^2} = 9.61 \frac{\text{m}}{\text{s}}; \quad V_2 = \frac{100/3600}{\pi(0.035)^2} = 7.22 \frac{\text{m}}{\text{s}}; \quad V_3 = \frac{120/3600}{\pi(0.02)^2} = 26.5 \frac{\text{m}}{\text{s}}$$

With gravity and heat transfer and internal energy neglected, the energy equation becomes

$$\dot{Q} - \dot{W}_s - \dot{W}_v = \dot{m}_3 \left( \frac{p_3}{\rho_3} + \frac{V_3^2}{2} \right) + \dot{m}_2 \left( \frac{p_2}{\rho_2} + \frac{V_2^2}{2} \right) - \dot{m}_1 \left( \frac{p_1}{\rho_1} + \frac{V_1^2}{2} \right),$$

$$\text{or: } -\dot{W}_s/\rho = \frac{100}{3600} \left[ \frac{225000}{998} + \frac{(7.22)^2}{2} \right] + \frac{120}{3600} \left[ \frac{265000}{998} + \frac{(26.5)^2}{2} \right] \\ + \frac{220}{3600} \left[ \frac{150000}{998} + \frac{(9.61)^2}{2} \right]$$

Solve for the shaft work:  $\dot{W}_s = 998(-6.99 - 20.56 + 12.00) \approx -15500 \text{ W}$  Ans.

(negative denotes work done on the fluid)

**3.127** A power plant on a river, as in Fig. P3.127, must eliminate 55 MW of waste heat to the river. The river conditions upstream are  $Q_1 = 2.5$  m<sup>3</sup>/s and  $T_1 = 18^\circ\text{C}$ . The river is 45 m wide and 2.7 m deep. If heat losses to the atmosphere and ground are negligible, estimate the downstream river conditions ( $Q_0, T_0$ ).

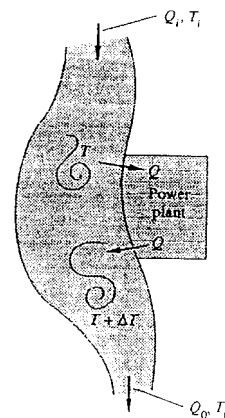


Fig. P3.127



**Solution:** For water, take  $c_p \approx 4280 \text{ J/kg} \cdot ^\circ\text{C}$ . For an overall CV enclosing the entire sketch,

$$\dot{Q} = \dot{m}_{\text{out}}(c_p T_{\text{out}}) - \dot{m}_{\text{in}}(c_p T_{\text{in}}),$$

or:  $55,000,000 \text{ W} \approx (998 \times 2.5)[4280 T_{\text{out}} - 4280(18)]$ , solve for  $T_{\text{out}} \approx \mathbf{23.15^\circ\text{C}}$  *Ans.*

The power plant flow is “internal” to the CV, hence  $Q_{\text{out}} = Q_{\text{in}} = \mathbf{2.5 \text{ m}^3/\text{s}}$ . *Ans.*

---

**3.128** For the conditions of Prob. 3.127, if the power plant is to heat the nearby river water by no more than  $12^\circ\text{C}$ , what should be the minimum flow rate  $Q$ , in  $\text{m}^3/\text{s}$ , through the plant heat exchanger? How will the value of  $Q$  affect the downstream conditions ( $Q_o$ ,  $T_o$ )?

**Solution:** Now let the CV only enclose the power plant, so that the flow going through the plant shows as an inlet and an outlet. The CV energy equation, with no work, gives

$$\dot{Q}_{\text{plant}} = \dot{m}_{\text{out}} c_p T_{\text{out}} - \dot{m}_{\text{in}} c_p T_{\text{in}} = (998)Q_{\text{plant}}(4280)(12^\circ\text{C}) \quad \text{since } Q_{\text{in}} = Q_{\text{out}}$$

$$\text{Solve for } Q_{\text{plant}} = \frac{55,000,000}{(998)(4280)(12)} \approx \mathbf{1.07 \text{ m}^3/\text{s}} \quad \text{Ans.}$$

It’s a lot of flow, but if the river water mixes well, the downstream flow is still the same.

---

**3.129** Multnomah Falls in the Columbia River Gorge has a sheer drop of 543 ft. Use the steady flow energy equation to estimate the water temperature rise, in  $^\circ\text{F}$ , resulting.

**Solution:** For water, convert  $c_p = 4200 \times 5.9798 = 25100 \text{ ft} \cdot \text{lbf}/(\text{slug} \cdot ^\circ\text{F})$ . Use the steady flow energy equation in the form of Eq. (3.66), with “1” upstream at the top of the falls:

$$h_1 + \frac{1}{2}V_1^2 + gz_1 = h_2 + \frac{1}{2}V_2^2 + gz_2 - q$$

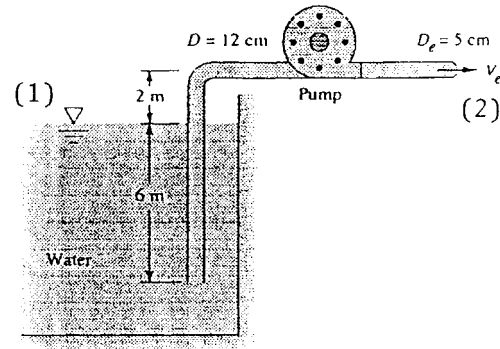
Assume adiabatic flow,  $q = 0$  (although evaporation might be important), and neglect the kinetic energies, which are much smaller than the potential energy change. Solve for

$$\Delta h = c_p \Delta T \approx g(z_1 - z_2), \quad \text{or: } \Delta T = \frac{32.2(543)}{25100} \approx \mathbf{0.70^\circ\text{F}} \quad \text{Ans.}$$


---

**3.130** When the pump in Fig. P3.130 draws  $220 \text{ m}^3/\text{h}$  of water at  $20^\circ\text{C}$  from the reservoir, the total friction head loss is  $5 \text{ m}$ . The flow discharges through a nozzle to the atmosphere. Estimate the pump power in kW delivered to the water.

**Solution:** Let “1” be at the reservoir surface and “2” be at the nozzle exit, as shown. We need to know the exit velocity:



**Fig. P3.130**

$$V_2 = Q/A_2 = \frac{220/3600}{\pi(0.025)^2} = 31.12 \frac{\text{m}}{\text{s}}, \quad \text{while } V_1 \approx 0 \text{ (reservoir surface)}$$

Now apply the steady flow energy equation from (1) to (2):

$$\frac{p_1}{\rho g} + \frac{V_1^2}{2g} + z_1 = \frac{p_2}{\rho g} + \frac{V_2^2}{2g} + z_2 + h_f - h_p,$$

$$\text{or: } 0 + 0 + 0 = 0 + (31.12)^2/[2(9.81)] + 2 + 5 - h_p, \quad \text{solve for } h_p \approx 56.4 \text{ m.}$$

$$\begin{aligned} \text{The pump power } P &= \rho g Q h_p = (998)(9.81)(220/3600)(56.4) \\ &= 33700 \text{ W} = \mathbf{33.7 \text{ kW}} \quad \text{Ans.} \end{aligned}$$

**3.131** When the pump in Fig. P3.130 delivers  $25 \text{ kW}$  of power to the water, the friction head loss is  $4 \text{ m}$ . Estimate (a) the exit velocity; and (b) the flow rate.

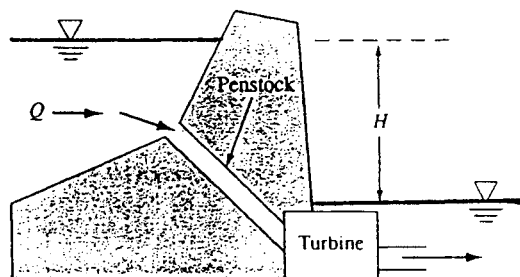
**Solution:** The energy equation just above must now be written with  $V_2$  and  $Q$  unknown:

$$0 + 0 + 0 = 0 + \frac{V_2^2}{2g} + 2 + 4 - h_p, \quad \text{where } h_p = \frac{P}{\rho g Q} = \frac{25000}{(998)(9.81)Q}$$

$$\text{and where } V_2 = \frac{Q}{\pi(0.025)^2}. \quad \text{Solve numerically by iteration: } V_2 \approx \mathbf{28.1 \text{ m/s}} \quad \text{Ans. (a)}$$

$$\text{and } Q = (28.1)\pi(0.025)^2 \approx 0.0552 \text{ m}^3/\text{s} \approx \mathbf{200 \text{ m}^3/\text{hr}} \quad \text{Ans. (b)}$$

**3.132** Consider a turbine extracting energy from a penstock in a dam, as in the figure. For turbulent flow (Chap. 6) the friction head loss is  $h_f = CQ^2$ , where the constant  $C$  depends upon penstock dimensions and water physical properties. Show that, for a given penstock and river flow  $Q$ , the maximum turbine power possible is  $P_{\max} = 2\rho gHQ/3$  and occurs when  $Q = (H/3C)^{1/2}$ .



**Solution:** Write the steady flow energy equation from point 1 on the upper surface to point 2 on the lower surface:

$$\frac{p_1}{\rho g} + \frac{V_1^2}{2g} + H = \frac{p_2}{\rho g} + \frac{V_2^2}{2g} + 0 + h_f + h_{\text{turbine}}$$

But  $p_1 = p_2 = p_{\text{atm}}$  and  $V_1 \approx V_2 \approx 0$ . Thus the turbine head is given by

$$h_t = H - h_f = H - CQ^2,$$

$$\text{or: Power} = P = \rho g Q h_t = \rho g Q H - \rho g C Q^3$$

Differentiate and set equal to zero for max power and appropriate flow rate:

$$\frac{dP}{dQ} = \rho g H - 3\rho g C Q^2 = 0 \quad \text{if } Q = \sqrt{H/3C} \quad \text{Ans.}$$

$$\text{Insert } Q \text{ in } P \text{ to obtain } P_{\max} = \rho g Q \left( \frac{2H}{3} \right) \quad \text{Ans.}$$

**3.133** The long pipe in Fig. 3.133 is filled with water at 20°C. When valve  $A$  is closed,  $p_1 - p_2 = 75$  kPa. When the valve is open and water flows at 500 m<sup>3</sup>/h,  $p_1 - p_2 = 160$  kPa. What is the friction head loss between 1 and 2, in m, for the flowing condition?

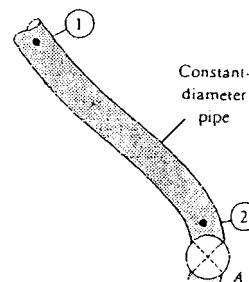


Fig. P3.133

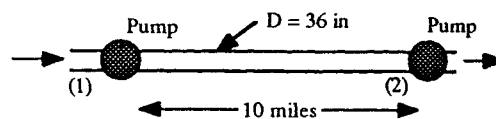
**Solution:** With the valve closed, there is no velocity or friction loss:

$$\frac{p_1}{\rho g} + z_1 = \frac{p_2}{\rho g} + z_2, \quad \text{or:} \quad z_2 - z_1 = \frac{p_1 - p_2}{\rho g} = \frac{75000}{998(9.81)} \approx 7.66 \text{ m}$$

When the valve is open, the velocity is the same at (1) and (2), thus “d” is not needed:

$$\text{With flow: } h_f = \frac{p_1 - p_2}{\rho g} + \frac{V_1^2 - V_2^2}{2g} + (z_1 - z_2) = \frac{160000}{998(9.81)} + 0 - 7.66 \approx \mathbf{8.7 \text{ m}} \quad \text{Ans.}$$

**3.134** A 36-in-diameter pipeline carries oil (SG = 0.89) at 1 million barrels per day (bbl/day) (1 bbl = 42 U.S. gal). The friction head loss is 13 ft/1000 ft of pipe. It is planned to place pumping stations every 10 mi along the pipe. Estimate the horsepower which must be delivered to the oil by each pump.



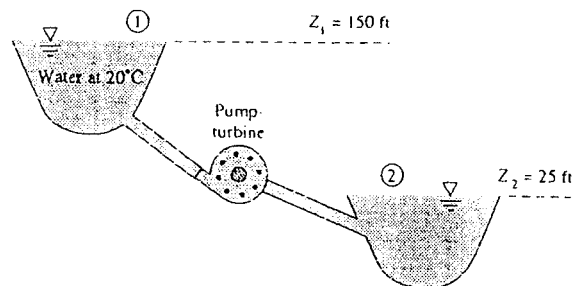
**Solution:** Since  $\Delta V$  and  $\Delta z$  are zero, the energy equation reduces to

$$h_f = \frac{\Delta p}{\rho g}, \quad \text{and} \quad h_f = 0.013 \frac{\text{ft-loss}}{\text{ft-pipe}} (10 \text{ mi}) \left( 5280 \frac{\text{ft}}{\text{mi}} \right) \approx 686 \text{ ft}$$

Convert the flow rate from 1E6 bbl/day to 29166 gal/min to **65.0** ft<sup>3</sup>/s. Then the power is

$$P = Q\Delta p = \gamma Q h_f = (62.4)(65.0)(686) = 2.78\text{E}6 \frac{\text{ft} \cdot \text{lb}_f}{\text{s}} \approx \mathbf{5060 \text{ hp}} \quad \text{Ans.}$$

**3.135** The *pump-turbine* system in Fig. P3.135 draws water from the upper reservoir in the daytime to produce power for a city. At night, it pumps water from lower to upper reservoirs to restore the situation. For a design flow rate of 15,000 gal/min in either direction, the friction head loss is 17 ft. Estimate the power in kW (a) extracted by the turbine and (b) delivered by the pump.



**Fig. P3.135**

**Solution:** (a) With the turbine, “1” is upstream:

$$\frac{p_1}{\rho g} + \frac{V_1^2}{2g} + z_1 = \frac{p_2}{\rho g} + \frac{V_2^2}{2g} + z_2 + h_f + h_t,$$

$$\text{or: } 0 + 0 + 150 = 0 + 0 + 25 + 17 = h_t$$

Solve for  $h_t = 108$  ft. Convert  $Q = 15000$  gal/min = **33.4** ft<sup>3</sup>/s. Then the turbine power is

$$P = \gamma Q h_{\text{turb}} = (62.4)(33.4)(108) = 225,000 \frac{\text{ft} \cdot \text{lbf}}{\text{s}} \approx \mathbf{410 \text{ hp}} \quad \text{Ans. (a)}$$

(b) For pump operation, point “2” is upstream:

$$\frac{p_2}{\rho g} + \frac{V_2^2}{2g} + z_2 = \frac{p_1}{\rho g} + \frac{V_1^2}{2g} + z_1 + h_f - h_p,$$

$$\text{or: } 0 + 0 + 25 = 0 + 0 + 150 + 17 - h_p$$

$$\text{Solve for } h_p \approx 142 \text{ ft}$$

The pump power is  $P_{\text{pump}} = \gamma Q h_p = (62.4)(33.4)(142) = 296000$  ft·lbf/s = **540 hp**. Ans. (b)

**3.136** Water at 20°C is delivered from one reservoir to another through a long 8-cm-diameter pipe. The lower reservoir has a surface elevation  $z_2 = 80$  m. The friction loss in the pipe is correlated by the formula  $h_{\text{loss}} \approx 17.5(V^2/2g)$ , where  $V$  is the average velocity in the pipe. If the steady flow rate through the pipe is 500 gallons per minute, estimate the surface elevation of the higher reservoir.

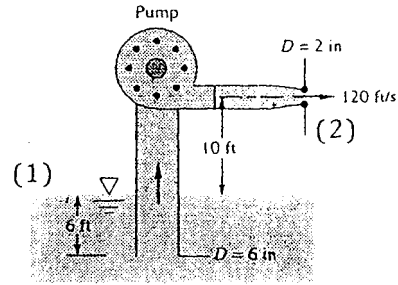
**Solution:** We may apply Bernoulli here,

$$h_f = \frac{17.5V^2}{2g} = z_1 - z_2$$

$$\frac{17.5}{2(9.81 \text{ m/s}^2)} \left[ \frac{(500 \text{ gal/min})(3.785 \text{ m}^3/\text{gal})(\text{min}/60 \text{ s})}{\frac{\pi}{4}(0.08^2)} \right]^2 = z_1 - 80 \text{ m}$$

$$z_1 \approx \mathbf{115 \text{ m}} \quad \text{Ans.}$$

**3.137** A fireboat draws seawater ( $SG = 1.025$ ) from a submerged pipe and discharges it through a nozzle, as in Fig. P3.137. The total head loss is 6.5 ft. If the pump efficiency is 75 percent, what horsepower motor is required to drive it?



**Fig. P3.137**

**Solution:** For seawater,  $\gamma = 1.025(62.4) = 63.96 \text{ lbf/ft}^3$ . The energy equation becomes

$$\frac{p_1}{\rho g} + \frac{V_1^2}{2g} + z_1 = \frac{p_2}{\rho g} + \frac{V_2^2}{2g} + z_2 + h_f - h_p,$$

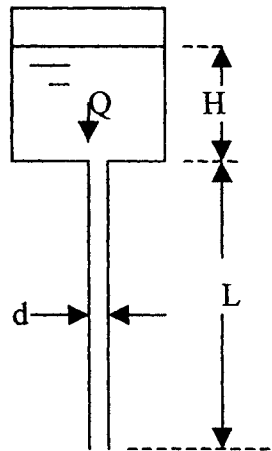
$$\text{or: } 0 + 0 + 0 = 0 + \frac{(120)^2}{2(32.2)} + 10 + 6.5 - h_p$$

Solve for  $h_p = 240 \text{ ft}$ . The flow rate is  $Q = V_2 A_2 = (120)(\pi/4)(2/12)^2 = 2.62 \text{ ft}^3/\text{s}$ . Then

$$P_{\text{pump}} = \frac{\gamma Q h_p}{\text{efficiency}} = \frac{(63.96)(2.62)(240)}{0.75} = 53600 \frac{\text{ft} \cdot \text{lbf}}{\text{s}} \approx \mathbf{97 \text{ hp}} \quad \text{Ans.}$$

**3.138** Students in the fluid mechanics lab at Penn State University use the device in the figure to measure the viscosity of water: a tank and a capillary tube. The flow is laminar and has negligible entrance loss, in which case Chap. 6 theory shows that  $h_f = 32\mu L V / (\rho g d^2)$ .

Students measure water temperature with a thermometer and  $Q$  with a stopwatch and a graduated cylinder. Density is measured by weighing a known volume. (a) Write an expression for  $\mu$  as a function of these variables. (b) Calculate  $\mu$  for the following actual data:  $T = 16.5^\circ\text{C}$ ,  $\rho = 998.7 \text{ kg/m}^3$ ,  $d = 0.041 \text{ in}$ ,  $Q = 0.31 \text{ mL/s}$ ,  $L = 36.1 \text{ in}$ , and  $H = 0.153 \text{ m}$ . (c) Compare this  $\mu$  with the published result for the same temperature. (d) Compute the error which would occur if one forgot to include the kinetic energy correction factor. Is this correction important here?



**Solution:** (a) Write the steady flow energy equation from top to bottom:

$$\frac{p_1}{\rho g} + \frac{\alpha_1 V_1^2}{2g} + (H + L) = \frac{p_2}{\rho g} + \frac{\alpha_2 V_2^2}{2g} + 0 + h_f, \quad \text{or: } h_f = \frac{32\mu LV}{\rho g d^2} = H + L - \frac{\alpha_2 V_2^2}{2g}$$

Noting that, in a tube,  $Q = V\pi d^2/4$ , we may eliminate  $V$  in favor of  $Q$  and solve for the fluid viscosity:

$$\mu = \frac{\pi\rho g d^4}{128LQ}(H + L) - \frac{\alpha_2\rho Q}{16\pi L} \quad \text{Ans. (a)}$$

(b) For the given data, converting  $d = 0.041 \text{ in} = 0.00104 \text{ m}$ ,  $L = 36.1 \text{ in} = 0.917 \text{ m}$ , and  $Q = 0.31 \text{ mL/s} = 3.1\text{E-}7 \text{ m}^3/\text{s}$ , we may substitute in the above formula (a) and calculate

$$\begin{aligned} \mu &= \frac{\pi(998.7)(9.81)(0.00104)^4}{128(0.917)(3.1\text{E-}7)}(0.153 + 0.917) - \frac{2.0(998.7)(3.1\text{E-}7)}{16\pi(0.917)} \\ &= 0.001063 - 0.000013 \approx \mathbf{0.00105} \frac{\text{kg}}{\text{m}\cdot\text{s}} \quad \text{Ans. (b)} \end{aligned}$$

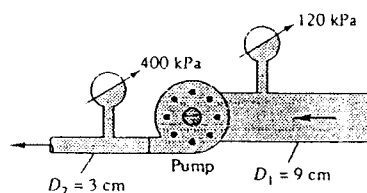
(c) The accepted value (see Appendix Table A-1) for water at  $16.5^\circ\text{C}$  is  $\mu \approx 1.11\text{E-}3 \text{ kg/m}\cdot\text{s}$ , the error in the experiment is thus about  $-5.5\%$ . *Ans. (c)*

(d) If we forgot the kinetic-energy correction factor  $\alpha_2 = 2.0$  for laminar flow, the calculation in part (b) above would result in

$$\mu = 0.001063 - 0.000007 \approx \mathbf{0.001056} \text{ kg/m}\cdot\text{s} \text{ (negligible 0.6\% error)} \quad \text{Ans. (d)}$$

In this experiment, the dominant (first) term is the *elevation change* ( $H + L$ )—the momentum exiting the tube is negligible because of the low velocity (0.36 m/s).

**3.139** The horizontal pump in Fig. P3.139 discharges  $20^\circ\text{C}$  water at  $57 \text{ m}^3/\text{h}$ . Neglecting losses, what power in kW is delivered to the water by the pump?



**Fig. P3.139**

**Solution:** First we need to compute the velocities at sections (1) and (2):

$$V_1 = \frac{Q}{A_1} = \frac{57/3600}{\pi(0.045)^2} = 2.49 \frac{\text{m}}{\text{s}}; \quad V_2 = \frac{Q}{A_2} = \frac{57/3600}{\pi(0.15)^2} = 22.4 \frac{\text{m}}{\text{s}}$$

Then apply the steady flow energy equation across the pump, neglecting losses:

$$\frac{p_1}{\rho g} + \frac{V_1^2}{2g} + z_1 = \frac{p_2}{\rho g} + \frac{V_2^2}{2g} + z_2 + h_f - h_p,$$

$$\text{or: } \frac{120000}{9790} + \frac{(2.49)^2}{2(9.81)} + 0 = \frac{400000}{9790} + \frac{(22.4)^2}{2(9.81)} + 0 + 0 - h_p, \quad \text{solve for } h_p \approx 53.85 \text{ m}$$

$$\text{Then the pump power is } P_p = \gamma Q h_p = 9790 \left( \frac{57}{3600} \right) (53.85) = 8350 \text{ W} = \mathbf{8.4 \text{ kW}} \quad \text{Ans.}$$

**3.140** Steam enters a horizontal turbine at 350 lbf/in<sup>2</sup> absolute, 580°C, and 12 ft/s and is discharged at 110 ft/s and 25°C saturated conditions. The mass flow is 2.5 lbm/s, and the heat losses are 7 Btu/lb of steam. If head losses are negligible, how much horsepower does the turbine develop?

**Solution:** We have to use the Steam Tables to find the enthalpies. State (2) is *saturated* vapor at 25°C = 77°F, for which we find  $h_2 \approx 1095.1 \text{ Btu/lbm} \approx 2.74\text{E}7 \text{ ft}\cdot\text{lbf/slug}$ . At state (1), 350 psia and 580°C = 1076°F, we find  $h_1 \approx 1565.3 \text{ Btu/lbm} \approx 3.92\text{E}7 \text{ ft}\cdot\text{lbf/slug}$ . The heat loss is 7 Btu/lbm  $\approx 1.75\text{E}5 \text{ ft}\cdot\text{lbf/slug}$ . The steady flow energy equation is best written on a per-mass basis:

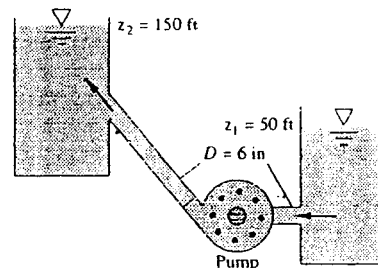
$$q - w_s = h_2 + \frac{1}{2} V_2^2 - h_1 - \frac{1}{2} V_1^2, \quad \text{or:}$$

$$-1.75\text{E}5 - w_s = 2.74\text{E}7 + (110)^2/2 - 3.92\text{E}7 - (12)^2/2, \quad \text{solve for } w_s \approx 1.16\text{E}7 \frac{\text{ft}\cdot\text{lbf}}{\text{slug}}$$

The result is positive because work is done by the fluid. The turbine power at 100% is

$$P_{\text{turb}} = \dot{m} w_s = \left( \frac{2.5}{32.2} \frac{\text{slug}}{\text{s}} \right) \left( 1.16\text{E}7 \frac{\text{ft}\cdot\text{lbf}}{\text{slug}} \right) = 901000 \frac{\text{ft}\cdot\text{lbf}}{\text{s}} \approx \mathbf{1640 \text{ hp}} \quad \text{Ans.}$$

**3.141** Water at 20°C is pumped at 1500 gal/min from the lower to the upper reservoir, as in Fig. P3.141. Pipe friction losses are approximated by  $h_f \approx 27V^2/(2g)$ , where  $V$  is the average velocity in the pipe. If the pump is 75 percent efficient, what horsepower is needed to drive it?



**Fig. P3.141**



**Solution:** First evaluate the average velocity in the pipe and the friction head loss:

$$Q = \frac{1500}{448.8} = 3.34 \frac{\text{ft}^3}{\text{s}}, \quad \text{so } V = \frac{Q}{A} = \frac{3.34}{\pi(3/12)^2} = 17.0 \frac{\text{ft}}{\text{s}} \quad \text{and} \quad h_f = 27 \frac{(17.0)^2}{2(32.2)} \approx \mathbf{121 \text{ ft}}$$

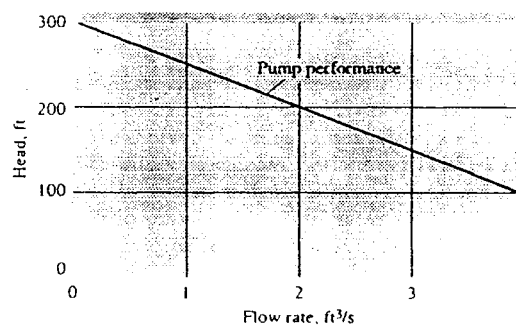
Then apply the steady flow energy equation:

$$\frac{p_1}{\rho g} + \frac{V_1^2}{2g} + z_1 = \frac{p_2}{\rho g} + \frac{V_2^2}{2g} + z_2 + h_f - h_p,$$

$$\text{or: } 0 + 0 + 50 = 0 + 0 + 150 + 121 - h_p$$

$$\begin{aligned} \text{Thus } h_p = 221 \text{ ft, so } P_{\text{pump}} &= \frac{\gamma Q h_p}{\eta} = \frac{(62.4)(3.34)(221)}{0.75} \\ &= 61600 \frac{\text{ft} \cdot \text{lb f}}{\text{s}} \approx \mathbf{112 \text{ hp}} \quad \text{Ans.} \end{aligned}$$

**3.142** A typical pump has a head which, for a given shaft rotation rate, varies with the flow rate, resulting in a *pump performance curve* as in Fig. P3.142. Suppose that this pump is 75 percent efficient and is used for the system in Prob. 3.141. Estimate (a) the flow rate, in gal/min, and (b) the horsepower needed to drive the pump.



**Fig. P3.142**

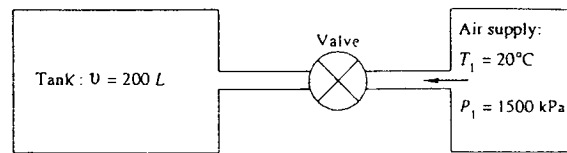
**Solution:** This time we do not know the flow rate, but the pump head is  $h_p \approx 300 - 50Q$ , with  $Q$  in cubic feet per second. The energy equation directly above becomes,

$$0 + 0 + 50 = 0 + 0 + 150 + (27) \frac{V^2}{2(32.2)} - (300 - 50Q), \quad \text{where } Q = V \frac{\pi}{4} (0.5 \text{ ft})^2$$

This becomes the quadratic  $Q^2 + 4.60Q - 18.4 = 0$ , solve for  $Q \approx 2.57 \text{ ft}^3/\text{s}$

$$\begin{aligned} \text{Then the power is } P_{\text{pump}} &= \frac{\gamma Q h_p}{\eta} = \frac{(62.4)(2.57)[300 - 50(2.57)]}{0.75} \\ &= 36700 \frac{\text{ft} \cdot \text{lb f}}{\text{s}} \approx \mathbf{67 \text{ hp}} \quad \text{Ans.} \end{aligned}$$

**3.143** The insulated tank in Fig. P3.143 is to be filled from a high-pressure air supply. Initial conditions in the tank are  $T = 20^\circ\text{C}$  and  $p = 200\text{ kPa}$ . When the valve is opened, the initial mass flow rate into the tank is  $0.013\text{ kg/s}$ . Assuming an ideal gas, estimate the initial rate of temperature rise of the air in the tank.



**Fig. P3.143**

**Solution:** For a CV surrounding the tank, with *unsteady* flow, the energy equation is

$$\frac{d}{dt} \left( \int e \rho dv \right) - \dot{m}_{\text{in}} \left( \hat{u} + \frac{p}{\rho} + \frac{V^2}{2} + gz \right) = \dot{Q} - \dot{W}_{\text{shaft}} = 0, \quad \text{neglect } V^2/2 \text{ and } gz$$

$$\text{Rewrite as } \frac{d}{dt} (\rho v c_v T) \approx \dot{m}_{\text{in}} c_p T_{\text{in}} = \rho v c_v \frac{dT}{dt} + c_v T v \frac{d\rho}{dt}$$

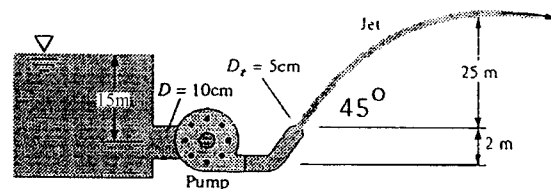
where  $\rho$  and  $T$  are the instantaneous conditions inside the tank. The CV mass flow gives

$$\frac{d}{dt} \left( \int \rho dv \right) - \dot{m}_{\text{in}} = 0, \quad \text{or: } v \frac{d\rho}{dt} = \dot{m}_{\text{in}}$$

Combine these two to eliminate  $v(d\rho/dt)$  and use the given data for air:

$$\left. \frac{dT}{dt} \right|_{\text{tank}} = \frac{\dot{m}(c_p - c_v)T}{\rho v c_v} = \frac{(0.013)(1005 - 718)(293)}{\left[ \frac{200000}{287(293)} \right] (0.2 \text{ m}^3)(718)} \approx 3.2 \frac{^\circ\text{C}}{\text{s}} \quad \text{Ans.}$$

**3.144** The pump in Fig. P3.144 creates a  $20^\circ\text{C}$  water jet oriented to travel a maximum horizontal distance. System friction head losses are  $6.5\text{ m}$ . The jet may be approximated by the trajectory of frictionless particles. What power must be delivered by the pump?



**Fig. P3.144**

**Solution:** For maximum travel, the jet must exit at  $\theta = 45^\circ$ , and the exit velocity must be

$$V_2 \sin \theta = \sqrt{2g\Delta z_{\text{max}}} \quad \text{or: } V_2 = \frac{[2(9.81)(25)]^{1/2}}{\sin 45^\circ} \approx 31.32 \frac{\text{m}}{\text{s}}$$

The steady flow energy equation for the piping system may then be evaluated:

$$p_1/\gamma + V_1^2/2g + z_1 = p_2/\gamma + V_2^2/2g + z_2 + h_f - h_p,$$

or:  $0 + 0 + 15 = 0 + (31.32)^2 / [2(9.81)] + 2 + 6.5 - h_p$ , solve for  $h_p \approx 43.5$  m

$$\text{Then } P_{\text{pump}} = \gamma Q h_p = (9790) \left[ \frac{\pi}{4} (0.05)^2 (31.32) \right] (43.5) \approx \mathbf{26200 \text{ W}} \quad \text{Ans.}$$

**3.145** The large turbine in Fig. P3.145 diverts the river flow under a dam as shown. System friction losses are  $h_f = 3.5V^2/(2g)$ , where  $V$  is the average velocity in the supply pipe. For what river flow rate in  $\text{m}^3/\text{s}$  will the power extracted be 25 MW? Which of the *two* possible solutions has a better “conversion efficiency”?

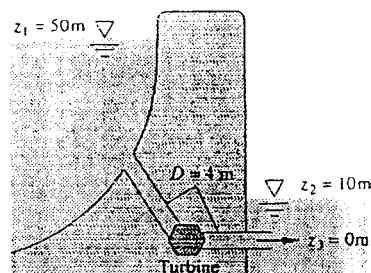


Fig. P3.145

**Solution:** The flow rate is the unknown, with the turbine power known:

$$\frac{p_1}{\gamma} + \frac{V_1^2}{2g} + z_1 = \frac{p_2}{\gamma} + \frac{V_2^2}{2g} + z_2 + h_f + h_{\text{turb}}, \quad \text{or: } 0 + 0 + 50 = 0 + 0 + 10 + h_f + h_{\text{turb}}$$

$$\text{where } h_f = 3.5V_{\text{pipe}}^2/(2g) \quad \text{and} \quad h_p = P_p/(\gamma Q) \quad \text{and} \quad V_{\text{pipe}} = \frac{Q}{(\pi/4)D_{\text{pipe}}^2}$$

Introduce the given numerical data (e.g.  $D_{\text{pipe}} = 4$  m,  $P_{\text{pump}} = 25\text{E}6$  W) and solve:

$$Q^3 - 35410Q + 2.261\text{E}6 = 0, \quad \text{with roots } Q = +76.5, +137.9, \text{ and } -214.4 \text{ m}^3/\text{s}$$

The *negative*  $Q$  is nonsense. The large  $Q$  ( $=137.9$ ) gives large friction loss,  $h_f \approx 21.5$  m. The smaller  $Q$  ( $=76.5$ ) gives  $h_f \approx 6.6$  m, about right. Select  $Q_{\text{river}} \approx \mathbf{76.5 \text{ m}^3/\text{s}}$ . *Ans.*

**3.146** Kerosene at  $20^\circ\text{C}$  flows through the pump in Fig. P3.146 at  $2.3 \text{ ft}^3/\text{s}$ . Head losses between 1 and 2 are 8 ft, and the pump delivers 8 hp to the flow. What should the mercury-manometer reading  $h$  ft be?

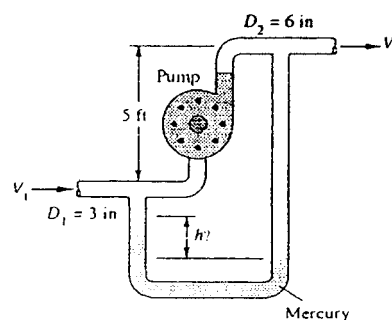


Fig. P3.146

**Solution:** First establish the two velocities:

$$\begin{aligned} V_1 &= \frac{Q}{A_1} = \frac{2.3 \text{ ft}^3/\text{s}}{(\pi/4)(3/12 \text{ ft})^2} \\ &= 46.9 \frac{\text{ft}}{\text{s}}; \quad V_2 = \frac{1}{4}V_1 = 11.7 \frac{\text{ft}}{\text{s}} \end{aligned}$$

For kerosene take  $\rho = 804 \text{ kg/m}^3 = 1.56 \text{ slug/ft}^3$ , or  $\gamma_k = 1.56(32.2) = 50.2 \text{ lbf/ft}^3$ . For mercury take  $\gamma_m = 846 \text{ lbf/ft}^3$ . Then apply a manometer analysis to determine the pressure difference between points 1 and 2:

$$p_2 - p_1 = (\gamma_m - \gamma_k)h - \gamma_k \Delta z = (846 - 50.2)h - \left(50.2 \frac{\text{lbf}}{\text{ft}^3}\right)(5 \text{ ft}) = 796h - 251 \frac{\text{lbf}}{\text{ft}^2}$$

Now apply the steady flow energy equation between points 1 and 2:

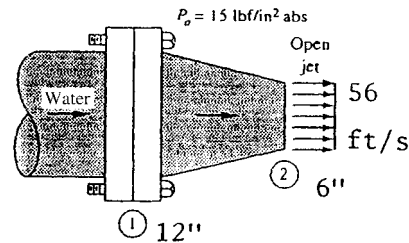
$$\frac{p_1}{\gamma_k} + \frac{V_1^2}{2g} + z_1 = \frac{p_2}{\gamma_k} + \frac{V_2^2}{2g} + z_2 + h_f - h_p, \quad \text{where } h_p = \frac{P}{\gamma_k Q} = \frac{8(550) \text{ ft} \cdot \text{lbf/s}}{(50.2)(2.3 \text{ ft}^3/\text{s})} = 38.1 \text{ ft}$$

$$\text{Thus: } \frac{p_1}{50.2} + \frac{(46.9)^2}{2(32.2)} + 0 = \frac{p_2}{50.2} + \frac{(11.7)^2}{2(32.2)} + 5 + 8 - 38.1 \text{ ft} \quad \text{Solve } p_2 - p_1 = 2866 \frac{\text{lbf}}{\text{ft}^2}$$

Now, with the pressure difference known, apply the manometer result to find  $h$ :

$$p_2 - p_1 = 2866 = 796h - 251, \quad \text{or: } h = \frac{2866 + 251 \text{ lbf/ft}^2}{796 \text{ lbf/ft}^3} = \mathbf{3.92 \text{ ft}} \quad \text{Ans.}$$

**3.147** Repeat Prob. 3.49 by assuming that  $p_1$  is unknown and using Bernoulli's equation with no losses. Compute the new bolt force for this assumption. What is the head loss between 1 and 2 for the data of Prob. 3.49?



**Fig. P3.49**

**Solution:** Use Bernoulli's equation with no losses to estimate  $p_1$  with  $\Delta z = 0$ :

$$\frac{p_1}{\gamma} + \frac{(14)^2}{2(32.2)} \approx \frac{15(144)}{62.4} + \frac{(56)^2}{2(32.2)}, \quad \text{solve for } p_{1,\text{ideal}} \approx \mathbf{34.8 \text{ psia}}$$

From the  $x$ -momentum CV analysis of Prob. 3.49, the bolt force is given by

$$\begin{aligned} F_{\text{bolts}} &= p_{2,\text{gage}} A_2 - \dot{m}(V_2 - V_1) \\ &= (34.8 - 15)(144) \frac{\pi}{4} (1 \text{ ft})^2 - 1.94 \left( \frac{\pi}{4} \right) (1 \text{ ft})^2 (14)(56 - 14) \approx \mathbf{1340 \text{ lbf}} \quad \text{Ans.} \end{aligned}$$

We can estimate the friction head loss in Prob. 3.49 from the steady flow energy equation, with  $p_1$  taken to be the value of 38 psia given in that problem:

$$\frac{38(144)}{62.4} + \frac{(14)^2}{2(32.2)} = \frac{15(144)}{62.4} + \frac{(56)^2}{2(32.2)} + h_f, \quad \text{solve for } h_f \approx \mathbf{7.4 \text{ ft}} \quad \text{Ans.}$$

**3.148** Reanalyze Prob. 3.54 to estimate the manometer reading  $h$  by Bernoulli's equation. For the reading  $h = 58 \text{ cm}$  in Prob. 3.54, what is the head loss?

**Solution:** We were given  $V_1 = 5 \text{ m/s}$ . Then, by mass conservation  $V_2 = V_1(8/5)^2 \approx 12.8 \text{ m/s}$ . Then find the upstream pressure by Bernoulli's equation with no losses:

$$\frac{p_1}{\rho} + \frac{V_1^2}{2} \approx \frac{p_2}{\rho} + \frac{V_2^2}{2}, \quad \text{or: } \frac{p_1}{998} + \frac{5^2}{2} = \frac{101000}{998} + \frac{(12.8)^2}{2}, \quad \text{solve for } p_1 \approx \mathbf{170300 \text{ Pa}}$$

Now apply the manometer formula to determine  $h$ :

$$p_1 - p_2 = 170300 - 101000 = (13550 - 998)(9.81)h, \\ \text{solve for } h = 0.563 \text{ m} = \mathbf{56.3 \text{ cm}} \quad \text{Ans.}$$

Estimate the friction head loss for the reading  $h = 58 \text{ cm}$  in Prob. 3.54:

$$\frac{p_1}{\gamma} + \frac{V_1^2}{2g} = \frac{p_2}{\gamma} + \frac{V_2^2}{2g} + h_f, \quad \text{or: } \frac{172300}{9790} + \frac{(5)^2}{2(9.81)} = \frac{101000}{9790} + \frac{(12.8)^2}{2(9.81)} + h_f$$

$$\text{Solve for } h_f \approx \mathbf{0.21 \text{ m}} \quad \text{Ans.}$$

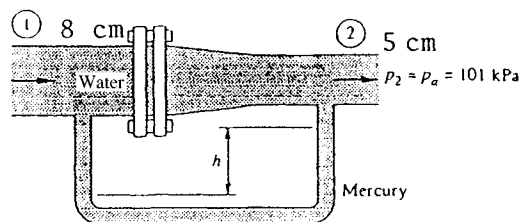
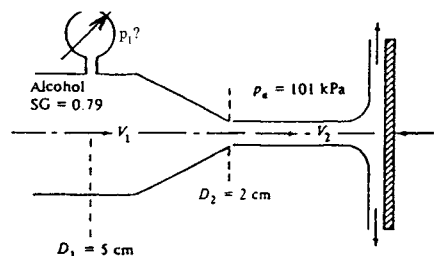


Fig. P3.54

**3.149** A jet of alcohol strikes the vertical plate in Fig. P3.149. A force  $F \approx 425 \text{ N}$  is required to hold the plate stationary. Assuming there are no losses in the nozzle, estimate (a) the mass flow rate of alcohol and (b) the absolute pressure at section 1.



**Solution:** A momentum analysis of the plate (e.g. Prob. 3.40) will give

$$F = \dot{m}V_2 = \rho A_2 V_2^2 = 0.79(998) \frac{\pi}{4} (0.02)^2 V_2^2 = 425 \text{ N},$$

$$\text{solve for } V_2 \approx 41.4 \text{ m/s}$$

$$\text{whence } \dot{m} = 0.79(998)(\pi/4)(0.02)^2(41.4) \approx \mathbf{10.3 \text{ kg/s}} \quad \text{Ans. (a)}$$

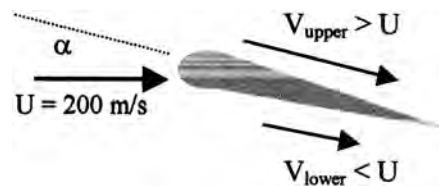
We find  $V_1$  from mass conservation and then find  $p_1$  from Bernoulli with no losses:

$$\text{Incompressible mass conservation: } V_1 = V_2(D_2/D_1)^2 = (41.4) \left(\frac{2}{5}\right)^2 \approx 6.63 \text{ m/s}$$

$$\text{Bernoulli, } z_1 = z_2: \quad p_1 = p_2 + \frac{1}{2} \rho (V_2^2 - V_1^2) = 101000 + \frac{0.79(998)}{2} [(41.4)^2 - (6.63)^2]$$

$$\approx \mathbf{760,000 \text{ Pa}} \quad \text{Ans. (b)}$$

**3.150** An airfoil at an angle of attack  $\alpha$ , as in Fig. P3.150, provides lift by a Bernoulli effect, because the lower surface slows the flow (high pressure) and the upper surface speeds up the flow (low pressure). If the foil is 1.5 m long and 18 m wide into the paper, and the ambient air is 5000 m standard atmosphere, estimate the total lift if the average velocities on upper and lower surfaces are 215 m/s and 185 m/s, respectively. Neglect gravity.



**Fig. P3.150**

**Solution:** A vertical force balance gives,

$$F_{\text{Lift}} = (p_l - p_u)A_{\text{planform}} = \frac{1}{2} \rho (V_u^2 - V_l^2)(bL)$$

$$= \frac{1}{2} (0.7361)(215^2 - 185^2)(18)(1.5)$$

$$= 119,250 \text{ N} = \mathbf{119 \text{ kN}} \quad \text{Ans.}$$

**3.151** Water flows through a circular nozzle, exits into the air as a jet, and strikes a plate. The force required to hold the plate steady is 70 N. Assuming frictionless one-dimensional flow, estimate (a) the velocities at sections (1) and (2); (b) the mercury manometer reading  $h$ .

**Solution:** (a) First examine the momentum of the jet striking the plate,

$$\sum F = F = -\dot{m}_{in}u_{in} = -\rho A_2 V_2^2$$

$$70 \text{ N} = -(998) \left( \frac{\pi}{4} \right) (0.03^2) (V_2^2) \quad V_2 = \mathbf{9.96 \text{ m/s}} \quad \text{Ans. (a)}$$

$$\text{Then } V_1 = \frac{V_2 A_2}{A_1} = \frac{(9.96) \left( \frac{\pi}{4} \right) (0.03^2)}{\frac{\pi}{4} (0.1^2)} \quad \text{or } V_1 = \mathbf{0.9 \text{ m/s}} \quad \text{Ans. (a)}$$

(b) Applying Bernoulli,

$$p_2 - p_1 = \frac{1}{2} \rho (V_2^2 - V_1^2) = \frac{1}{2} (998) (9.96^2 - 0.9^2) = 49,100 \text{ Pa}$$

And from our manometry principles,

$$h = \frac{\Delta p}{\rho g} = \frac{49,100}{(133,100 - 9790)} \approx \mathbf{0.4 \text{ m}} \quad \text{Ans. (b)}$$

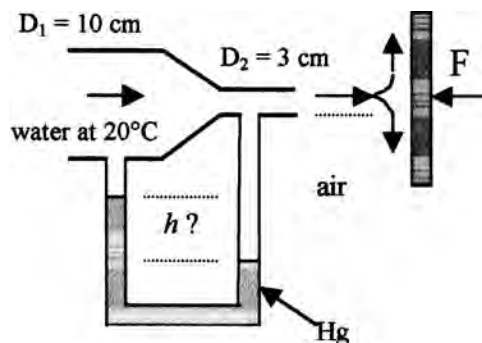


Fig. P3.151

**3.152** A free liquid jet, as in Fig. P3.152, has constant ambient pressure and small losses; hence from Bernoulli's equation  $z + V^2/(2g)$  is constant along the jet. For the fire nozzle in the figure, what are (a) the minimum and (b) the maximum values of  $\theta$  for which the water jet will clear the corner of the building? For which case will the jet velocity be higher when it strikes the roof of the building?

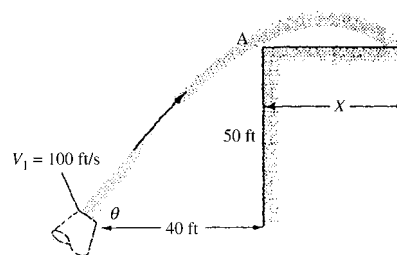


Fig. P3.152

**Solution:** The two extreme cases are when the jet just touches the corner A of the building. For these two cases, Bernoulli's equation requires that

$$V_1^2 + 2gz_1 = (100)^2 + 2g(0) = V_A^2 + 2gz_A = V_A^2 + 2(32.2)(50), \quad \text{or: } V_A = 82.3 \frac{\text{ft}}{\text{s}}$$

The jet moves like a frictionless particle as in elementary particle dynamics:

$$\text{Vertical motion: } z = V_1 \sin \theta t - \frac{1}{2}gt^2; \quad \text{Horizontal motion: } x = V_1 \cos \theta t$$

Eliminate "t" between these two and apply the result to point A:

$$z_A = 50 = x_A \tan \theta - \frac{gx_A^2}{2V_1^2 \cos^2 \theta} = 40 \tan \theta - \frac{(32.2)(40)^2}{2(100)^2 \cos^2 \theta}; \quad \text{clean up and rearrange:}$$

$$\tan \theta = 1.25 + 0.0644 \sec^2 \theta, \quad \text{solve for } \theta = \mathbf{85.94^\circ} \quad \text{Ans. (a)} \quad \text{and } \mathbf{55.40^\circ} \quad \text{Ans. (b)}$$

Path (b) is shown in the figure, where the jet just grazes the corner A and goes over the top of the roof. Path (a) goes nearly straight up, to  $z = 155$  ft, then falls down to pt. A.

**3.153** For the container of Fig. P3.153 use Bernoulli's equation to derive a formula for the distance  $X$  where the free jet leaving horizontally will strike the floor, as a function of  $h$  and  $H$ . For what ratio  $h/H$  will  $X$  be maximum? Sketch the three trajectories for  $h/H = 0.4, 0.5,$  and  $0.6$ .

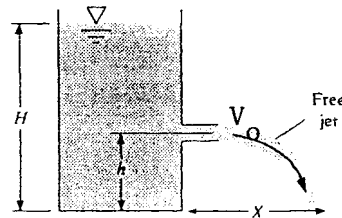


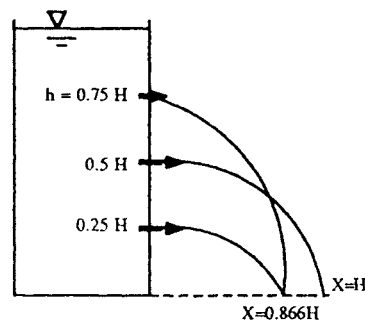
Fig. P3.153

**Solution:** The velocity out the hole and the time to fall from hole to ground are given by

$$V_o = \sqrt{2g(H-h)} \quad t_{\text{fall}} = \sqrt{2h/g}$$

Then the distance travelled horizontally is

$$X = V_o t_{\text{fall}} = \mathbf{2\sqrt{h(H-h)}} \quad \text{Ans.}$$





Maximum  $X$  occurs at  $h = H/2$ , or  $X_{\max} = H$ . When  $h = 0.25H$  or  $0.75H$ , the jet travels out to  $H = 0.866H$ . These three trajectories are shown in the sketch on the previous page.

**3.154** In Fig. P3.154 the exit nozzle is horizontal. If losses are negligible, what should the water level  $h$  cm be for the free jet to just clear the wall?

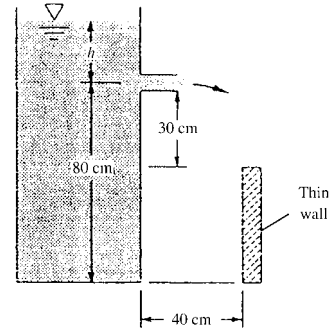


Fig. P3.154

**Solution:** The fall distance is 0.3 m =  $(1/2)gt^2$ , hence  $t = [2(0.3)/g]$ . The exit velocity is  $V = \sqrt{2gh}$ . Then

$$x = 0.4 \text{ m} = V_0 t = (2gh)^{1/2} [2(0.3)/g]^{1/2}$$

$$= 2(0.3h)^{1/2}, \text{ or: } h \approx \mathbf{0.133 \text{ m}} \text{ Ans.}$$

**3.155** Bernoulli's 1738 treatise *Hydrodynamica* contains many excellent sketches of flow patterns. One, however, redrawn here as Fig. P3.155, seems physically misleading. What is wrong with the drawing?

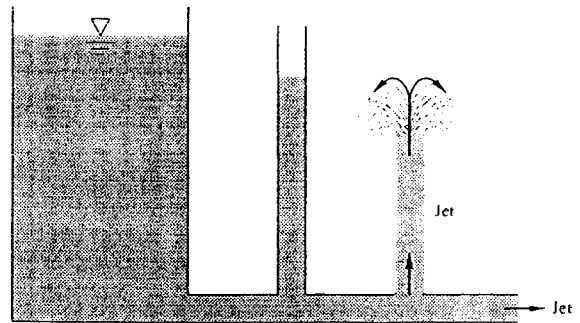
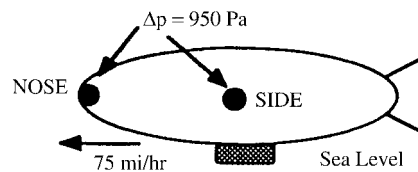


Fig. P3.155

**Solution:** If friction is neglected and the exit pipe is fully open, then pressure in the closed "piezometer" tube would be atmospheric and the fluid would not rise at all in the tube. The open jet coming from the hole in the tube would have  $V \approx \sqrt{2gh}$  and would rise up to nearly the same height as the water in the tank.

**3.156** A blimp cruises at 75 mi/h through sea-level standard air. A differential pressure transducer connected between the nose and the side of the blimp registers 950 Pa. Estimate (a) the absolute pressure at the nose and (b) the absolute velocity of the air near the blimp side.



**Solution:** Assume that the nose reads “stagnation” pressure and the side reads the local side pressure and senses a local velocity not equal to the blimp speed. The nose velocity is zero.

Then Bernoulli’s equation, assuming  $\Delta z = 0$ , yields

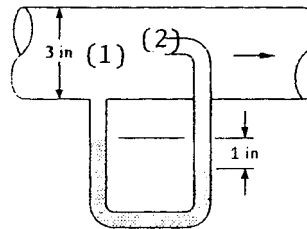
$$p_{nose} + \frac{1}{2}\rho V_{nose}^2 = p_{side} + \frac{1}{2}\rho V_{side}^2, \quad \text{or: } p_{nose} - p_{side} = 950 \text{ Pa} = \frac{1}{2}\left(1.225 \frac{\text{kg}}{\text{m}^3}\right) V_{side}^2$$

$$\text{solve for } V_{side} \approx 39.4 \frac{\text{m}}{\text{s}} = \mathbf{88 \text{ mi/hr}} \quad \text{Ans. (b)}$$

Now relate Bernoulli to the ambient upstream conditions,  $V_{blimp} = 75 \text{ mi/hr} = 33.5 \text{ m/s}$ :

$$p_{nose} = p_{atm} + \frac{1}{2}\rho V_{vehicle}^2 = 101350 + \frac{1.225}{2}(33.5)^2 = \mathbf{102,000 \text{ Pa}} \quad \text{Ans. (a)}$$

**3.157** The manometer fluid in Fig. P3.157 is mercury. Estimate the volume flow in the tube if the flowing fluid is (a) gasoline and (b) nitrogen, at 20°C and 1 atm.



**Fig. P3.157**

**Solution:** For gasoline (a) take  $\rho = 1.32 \text{ slug/ft}^3$ . For nitrogen (b),  $R \approx 297 \text{ J/kg}\cdot^\circ\text{C}$  and  $\rho = p/RT = (101350)/[(297)(293)] \approx 1.165 \text{ kg/m}^3 = 0.00226 \text{ slug/ft}^3$ . For mercury, take  $\rho \approx 26.34 \text{ slug/ft}^3$ . The pitot tube (2) reads stagnation pressure, and the wall hole (1) reads static pressure. Thus Bernoulli’s relation becomes, with  $\Delta z = 0$ ,

$$p_1 + \frac{1}{2}\rho V_1^2 = p_2, \quad \text{or } V_1 = \sqrt{2(p_2 - p_1)/\rho}$$

The pressure difference is found from the manometer reading, for each fluid in turn:

$$\text{(a) Gasoline: } \Delta p = (\rho_{\text{Hg}} - \rho)gh = (26.34 - 1.32)(32.2)(1/12 \text{ ft}) \approx 67.1 \text{ lbf/ft}^2$$

$$V_1 = [2(67.1)/1.32]^{1/2} = 10.1 \frac{\text{ft}}{\text{s}}, \quad Q = V_1 A_1 = (10.1) \left(\frac{\pi}{4}\right) \left(\frac{3}{12}\right)^2 = \mathbf{0.495 \frac{\text{ft}^3}{\text{s}}} \quad \text{Ans. (a)}$$

$$\text{(b) N}_2: \Delta p = (\rho_{\text{Hg}} - \rho)gh = (26.34 - 0.00226)(32.2)(1/12) \approx 70.7 \text{ lbf/ft}^2$$

$$V_1 = [2(70.7)/0.00226]^{1/2} = 250 \frac{\text{ft}}{\text{s}}, \quad Q = V_1 A_1 = (250) \left(\frac{\pi}{4}\right) \left(\frac{3}{12}\right)^2 \approx \mathbf{12.3 \frac{\text{ft}^3}{\text{s}}} \quad \text{Ans. (b)}$$

**3.158** In Fig. P3.158 the flowing fluid is  $\text{CO}_2$  at  $20^\circ\text{C}$ . Neglect losses. If  $p_1 = 170 \text{ kPa}$  and the manometer fluid is Meriam red oil ( $\text{SG} = 0.827$ ), estimate (a)  $p_2$  and (b) the gas flow rate in  $\text{m}^3/\text{h}$ .

**Solution:** Estimate the  $\text{CO}_2$  density as  $\rho = p/RT = (170000)/[189(293)] \approx 3.07 \text{ kg/m}^3$ . The manometer reading gives the downstream pressure:

$$p_1 - p_2 = (\rho_{\text{oil}} - \rho_{\text{CO}_2})gh = [0.827(998) - 3.07](9.81)(0.08) \approx 645 \text{ Pa}$$

$$\text{Hence } p_2 = 170,000 - 645 \approx \mathbf{169400 \text{ Pa}} \quad \text{Ans. (a)}$$

Now use Bernoulli to find  $V_2$ , assuming  $p_1 \approx$  stagnation pressure ( $V_1 = 0$ ):

$$p_1 + \frac{1}{2}\rho(0)^2 \approx p_2 + \frac{1}{2}\rho V_2^2,$$

$$\text{or: } V_2 = \sqrt{\frac{2(p_1 - p_2)}{\rho}} = \sqrt{\frac{2(645)}{3.07}} \approx 20.5 \frac{\text{m}}{\text{s}}$$

$$\text{Then } Q = V_2 A_2 = (20.5)(\pi/4)(0.06)^2 = 0.058 \text{ m}^3/\text{s} \approx \mathbf{209 \frac{\text{m}^3}{\text{hr}}} \quad \text{Ans. (b)}$$

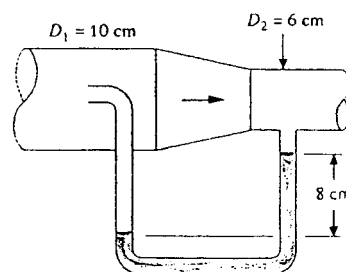
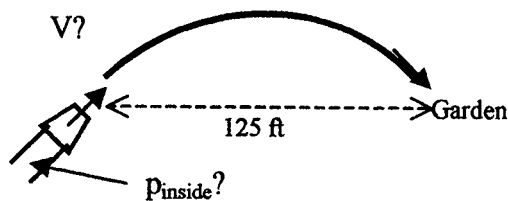


Fig. P3.158

**3.159** Our  $D = 0.625$ -in-diameter hose is too short, and it is 125 ft from the  $d = 0.375$ -in-diameter nozzle exit to the garden. If losses are neglected, what is the minimum gage pressure required, inside the hose, to reach the garden?



**Solution:** Assume that the water jet from the hose approximates the trajectory of a frictionless particle. Then  $\Delta x = 125 \text{ ft}$  can be translated to the jet velocity needed:

$$\Delta x_{\text{max}} = 125 \text{ ft} = \frac{V_{\text{jet}}^2}{g} = \frac{V_{\text{jet}}^2}{32.2}, \quad \text{solve for } V_{\text{jet}} = 63.44 \text{ ft/s}$$

Then write Bernoulli's equation and continuity from outside to inside of the nozzle:

$$\begin{aligned}
 P_{inside} - P_{atm} &= \frac{\rho}{2} V_{jet}^2 \left[ 1 - \left( \frac{d}{D} \right)^4 \right] = \frac{1.94 \text{ slug/ft}^3}{2} \left( 63.4 \frac{\text{ft}}{\text{s}} \right)^2 \left[ 1 - \left( \frac{0.375}{0.625} \right)^4 \right] \\
 &= 3400 \frac{\text{lbf}}{\text{ft}^2} \quad \text{Ans.}
 \end{aligned}$$

**3.160** The air-cushion vehicle in Fig. P3.160 brings in sea-level standard air through a fan and discharges it at high velocity through an annular skirt of 3-cm clearance. If the vehicle weighs 50 kN, estimate (a) the required airflow rate and (b) the fan power in kW.

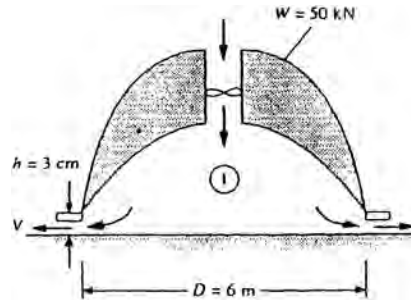


Fig. P3.160

**Solution:** The air inside at section 1 is nearly stagnant ( $V \approx 0$ ) and supports the weight and also drives the flow out of the interior into the atmosphere:

$$P_1 \approx P_{01}: \quad P_{01} - P_{atm} = \frac{\text{weight}}{\text{area}} = \frac{50,000 \text{ N}}{\pi(3 \text{ m})^2} = \frac{1}{2} \rho V_{\text{exit}}^2 = \frac{1}{2} (1.205) V_{\text{exit}}^2 \approx 1768 \text{ Pa}$$

$$\text{Solve for } V_{\text{exit}} \approx 54.2 \text{ m/s, whence } Q_e = A_e V_e = \pi(6)(0.03)(54.2) = 30.6 \frac{\text{m}^3}{\text{s}}$$

Then the power required by the fan is  $P = Q_e \Delta p = (30.6)(1768) \approx 54000 \text{ W}$  Ans.

**3.161** A necked-down section in a pipe flow, called a *venturi*, develops a low throat pressure which can aspirate fluid upward from a reservoir, as in Fig. P3.161. Using Bernoulli's equation with no losses, derive an expression for the velocity  $V_1$  which is just sufficient to bring reservoir fluid into the throat.

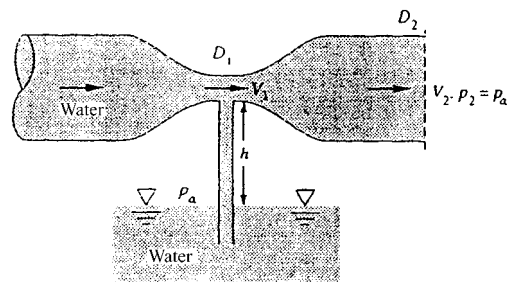


Fig. P3.161

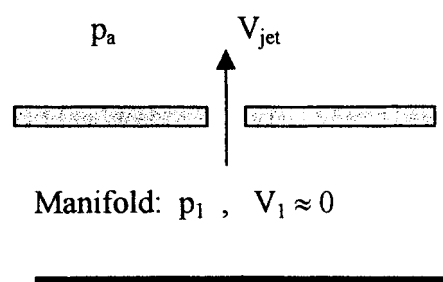
**Solution:** Water will begin to aspirate into the throat when  $p_a - p_1 = \rho gh$ . Hence:

$$\text{Volume flow: } V_1 = V_2(D_2/D_1)^2; \text{ Bernoulli } (\Delta z = 0): p_1 + \frac{1}{2}\rho V_1^2 \approx p_{\text{atm}} + \frac{1}{2}\rho V_2^2$$

$$\text{Solve for } p_a - p_1 = \frac{\rho}{2}(\alpha^4 - 1)V_2^2 \geq \rho gh, \quad \alpha = \frac{D_2}{D_1}, \quad \text{or: } V_2 \geq \sqrt{\frac{2gh}{\alpha^4 - 1}} \quad \text{Ans.}$$

$$\text{Similarly, } V_{1,\min} = \alpha^2 V_{2,\min} = \sqrt{\frac{2gh}{1 - (D_1/D_2)^4}} \quad \text{Ans.}$$

**3.162** Suppose you are designing a  $3 \times 6$ -ft air-hockey table, with 1/16-inch-diameter holes spaced every inch in a rectangular pattern (2592 holes total), the required jet speed from each hole is 50 ft/s. You must select an appropriate blower. Estimate the volumetric flow rate (in  $\text{ft}^3/\text{min}$ ) and pressure rise (in psi) required. *Hint:* Assume the air is stagnant in the large manifold under the table surface, and neglect frictional losses.



**Solution:** Assume an air density of about sea-level,  $0.00235 \text{ slug/ft}^3$ . Apply Bernoulli's equation through any single hole, as in the figure:

$$p_1 + \frac{\rho}{2}V_1^2 = p_a + \frac{\rho}{2}V_{\text{jet}}^2, \quad \text{or:}$$

$$\Delta p_{\text{required}} = p_1 - p_a = \frac{\rho}{2}V_{\text{jet}}^2 = \frac{0.00235}{2}(50)^2 = 2.94 \frac{\text{lbf}}{\text{ft}^2} = \mathbf{0.0204 \frac{\text{lbf}}{\text{in}^2}} \quad \text{Ans.}$$

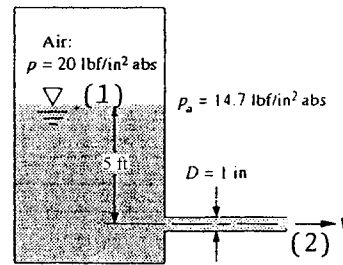
The total volume flow required is

$$\begin{aligned} Q &= VA_{1-\text{hole}}(\# \text{ of holes}) = \left(50 \frac{\text{ft}}{\text{s}}\right) \pi \left(\frac{1/16}{12} \text{ft}\right)^2 (2592 \text{ holes}) \\ &= 2.76 \frac{\text{ft}^3}{\text{s}} = \mathbf{166 \frac{\text{ft}^3}{\text{min}}} \quad \text{Ans.} \end{aligned}$$

It wasn't asked, but the power required would be  $P = Q\Delta p = (2.76 \text{ ft}^3/\text{s})(2.94 \text{ lbf/ft}^2) = 8.1 \text{ ft}\cdot\text{lbf/s}$ , or about 11 watts.

**3.163** The liquid in Fig. P3.163 is kerosine at 20°C. Estimate the flow rate from the tank for (a) no losses and (b) pipe losses  $h_f \approx 4.5V^2/(2g)$ .

**Solution:** For kerosine let  $\gamma = 50.3 \text{ lbf/ft}^3$ . Let (1) be the surface and (2) the exit jet:



**Fig. P3.163**

$$\frac{p_1}{\gamma} + \frac{V_1^2}{2g} + z_1 = \frac{p_2}{\gamma} + \frac{V_2^2}{2g} + z_2 + h_f, \quad \text{with } z_2 = 0 \text{ and } V_1 \approx 0, \quad h_f = K \frac{V_2^2}{2g}$$

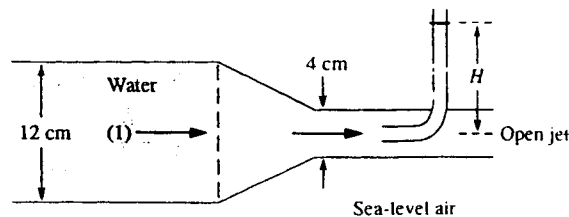
$$\text{Solve for } \frac{V_2^2}{2g}(1+K) = z_1 + \frac{p_1 - p_2}{\gamma} = 5 + \frac{(20 - 14.7)(144)}{50.3} \approx 20.2 \text{ ft}$$

We are asked to compute two cases (a) no losses; and (b) substantial losses,  $K \approx 4.5$ :

$$\text{(a) } K = 0: \quad V_2 = \left[ \frac{2(32.2)(20.2)}{1+0} \right]^{1/2} = 36.0 \frac{\text{ft}}{\text{s}}, \quad Q = 36.0 \frac{\pi}{4} \left( \frac{1}{12} \right)^2 \approx \mathbf{0.197} \frac{\text{ft}^3}{\text{s}} \quad \text{Ans. (a)}$$

$$\text{(b) } K = 4.5: \quad V_2 = \sqrt{\frac{2(32.2)(23.0)}{1+4.5}} = 16.4 \frac{\text{ft}}{\text{s}}, \quad Q = 16.4 \frac{\pi}{4} \left( \frac{1}{12} \right)^2 \approx \mathbf{0.089} \frac{\text{ft}^3}{\text{s}} \quad \text{Ans. (b)}$$

**3.164** An open water jet exits from a nozzle into sea-level air, as shown, and strikes a stagnation tube. If the centerline pressure at section (1) is 110 kPa and losses are neglected, estimate (a) the mass flow in kg/s; and (b) the height  $H$  of the fluid in the tube.



**Fig. P3.164**

**Solution:** Writing Bernoulli and continuity between pipe and jet yields jet velocity:

$$p_1 - p_a = \frac{\rho}{2} V_{jet}^2 \left[ 1 - \left( \frac{D_{jet}}{D_1} \right)^4 \right] = 110000 - 101350 = \frac{998}{2} V_{jet}^2 \left[ 1 - \left( \frac{4}{12} \right)^4 \right],$$

$$\text{solve } V_{jet} = \mathbf{4.19} \frac{\text{m}}{\text{s}}$$

$$\text{Then the mass flow is } \dot{m} = \rho A_{jet} V_{jet} = 998 \frac{\pi}{4} (0.04)^2 (4.19) = \mathbf{5.25} \frac{\text{kg}}{\text{s}} \quad \text{Ans. (a)}$$

(b) The water in the stagnation tube will rise above the jet surface by an amount equal to the stagnation pressure head of the jet:

$$\mathbf{H} = R_{jet} + \frac{V_{jet}^2}{2g} = 0.02 \text{ m} + \frac{(4.19)^2}{2(9.81)} = 0.02 + 0.89 = \mathbf{0.91 \text{ m}} \quad \text{Ans. (b)}$$

**3.165** A *venturi meter*, shown in Fig. P3.165, is a carefully designed constriction whose pressure difference is a measure of the flow rate in a pipe. Using Bernoulli's equation for steady incompressible flow with no losses, show that the flow rate  $Q$  is related to the manometer reading  $h$  by

$$Q = \frac{A_2}{\sqrt{1 - (D_2/D_1)^4}} \sqrt{\frac{2gh(\rho_M - \rho)}{\rho}}$$

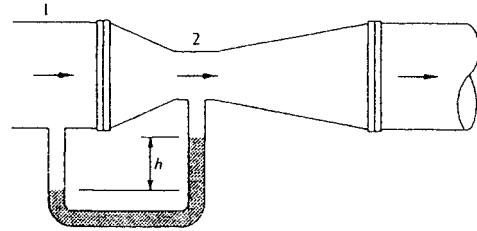


Fig. P3.165

where  $\rho_M$  is the density of the manometer fluid.

**Solution:** First establish that the manometer reads the pressure difference between 1 and 2:

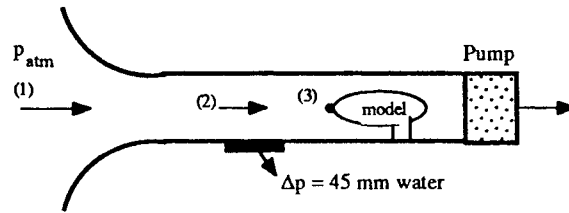
$$p_1 - p_2 = (\rho_M - \rho)gh \quad (1)$$

Then write incompressible Bernoulli's equation and continuity between (1) and (2):

$$(\Delta z = 0): \quad \frac{p_1}{\rho} + \frac{V_1^2}{2} \approx \frac{p_2}{\rho} + \frac{V_2^2}{2} \quad \text{and} \quad V_2 = V_1(D_1/D_2)^2, \quad Q = A_1 V_1 = A_2 V_2$$

$$\text{Eliminate } V_2 \text{ and } (p_1 - p_2) \text{ from (1) above:} \quad \mathbf{Q} = \frac{A_2 \sqrt{2gh(\rho_M - \rho)/\rho}}{\sqrt{1 - (D_2/D_1)^4}} \quad \text{Ans.}$$

**3.166** A wind tunnel draws in sea-level standard air from the room and accelerates it into a 1-m by 1-m test section. A pressure transducer in the test section wall measures  $\Delta p = 45 \text{ mm water}$  between inside and outside. Estimate (a) the test section velocity in mi/hr; and (b) the absolute pressure at the nose of the model.



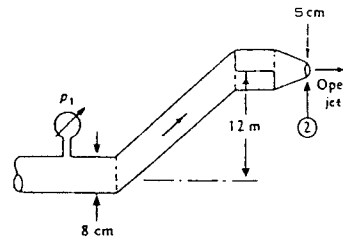
**Solution:** (a) First apply Bernoulli from the atmosphere (1) to (2), using the known  $\Delta p$ :

$$p_a - p_2 = 45 \text{ mm H}_2\text{O} = 441 \text{ Pa}; \quad \rho_a = 1.225 \text{ kg/m}^3; \quad p_1 + \frac{\rho}{2} V_1^2 \approx p_2 + \frac{\rho}{2} V_2^2$$

Since  $V_1 \approx 0$  and  $p_1 = p_a$ , we obtain  $V_2 = \sqrt{\frac{2\Delta p}{\rho}} = \sqrt{\frac{2(441)}{1.225}} = 26.8 \frac{\text{m}}{\text{s}} = \mathbf{60 \frac{mi}{hr}}$  *Ans. (a)*

(b) Bernoulli from 1 to 3: both velocities = 0, so  $p_{\text{nose}} = p_a \approx \mathbf{101350 \text{ Pa}}$ . *Ans. (b)*

**3.167** In Fig. P3.167 the fluid is gasoline at  $20^\circ\text{C}$  at a weight flux of  $120 \text{ N/s}$ . Assuming no losses, estimate the gage pressure at section 1.



**Fig. P3.167**

**Solution:** For gasoline,  $\rho = 680 \text{ kg/m}^3$ . Compute the velocities from the given flow rate:

$$Q = \frac{\dot{W}}{\rho g} = \frac{120 \text{ N/s}}{680(9.81)} = 0.018 \frac{\text{m}^3}{\text{s}},$$

$$V_1 = \frac{0.018}{\pi(0.04)^2} = 3.58 \frac{\text{m}}{\text{s}}; \quad V_2 = \frac{0.018}{\pi(0.025)^2} = 9.16 \frac{\text{m}}{\text{s}}$$

Now apply Bernoulli between 1 and 2:

$$\frac{p_1}{\rho} + \frac{V_1^2}{2} + gz_1 \approx \frac{p_2}{\rho} + \frac{V_2^2}{2} + gz_2, \quad \text{or:} \quad \frac{p_1}{\rho} + \frac{(3.58)^2}{2} + 0 \approx \frac{0(\text{gage})}{680} + \frac{(9.16)^2}{2} + 9.81(12)$$

Solve for  $p_1 \approx \mathbf{104,000 \text{ Pa (gage)}}$  *Ans.*



**3.168** In Fig. P3.168 both fluids are at 20°C. If  $V_1 = 1.7$  ft/s and losses are neglected, what should the manometer reading  $h$  ft be?

**Solution:** By continuity, establish  $V_2$ :

$$V_2 = V_1(D_1/D_2)^2 = 1.7(3/1)^2 = 15.3 \frac{\text{ft}}{\text{s}}$$

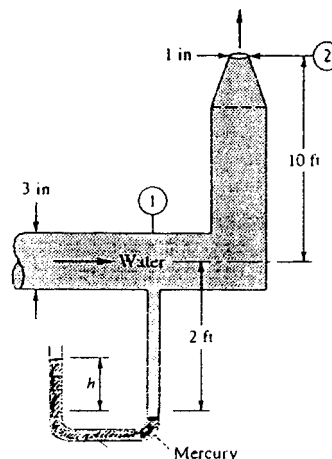
Now apply Bernoulli between 1 and 2 to establish the pressure at section 2:

$$p_1 + \frac{\rho}{2} V_1^2 + \rho g z_1 = p_2 + \frac{\rho}{2} V_2^2 + \rho g z_2,$$

$$\text{or: } p_1 + (1.94/2)(1.7)^2 + 0 \approx 0 + (1.94/2)(15.3)^2 + (62.4)(10), \quad p_1 = 848 \text{ psf}$$

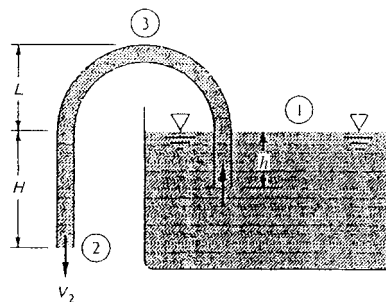
This is gage pressure. Now the manometer *reads* gage pressure, so

$$p_1 - p_a = 848 \frac{\text{lbf}}{\text{ft}^2} = (\rho_{\text{merc}} - \rho_{\text{water}})gh = (846 - 62.4)h, \quad \text{solve for } h \approx \mathbf{1.08 \text{ ft}} \quad \text{Ans.}$$



**Fig. P3.168**

**3.169** Once it has been started by sufficient suction, the *siphon* in Fig. P3.169 will run continuously as long as reservoir fluid is available. Using Bernoulli's equation with no losses, show (a) that the exit velocity  $V_2$  depends only upon gravity and the distance  $H$  and (b) that the lowest (vacuum) pressure occurs at point 3 and depends on the distance  $L + H$ .



**Fig. P3.169**

**Solution:** Write Bernoulli from 1 to 2:

$$\frac{p_1}{\gamma} + \frac{V_1^2}{2g} + z_1 \approx \frac{p_2}{\gamma} + \frac{V_2^2}{2g} + z_2, \quad \text{or: } \frac{p_a}{\gamma} + 0 + z_1 \approx \frac{p_a}{\gamma} + \frac{V_2^2}{2g} + z_2$$

$$\text{Solve for } V_2 = V_{\text{exit}} = \sqrt{2g(z_1 - z_2)} = \sqrt{2gH} \quad \text{Ans.}$$

Since the velocity is constant throughout the tube, at any point C inside the tube,

$$p_C + \gamma z_C \approx p_a + \gamma z_2, \quad \text{or, at point 3: } p_{C, \min} = p_a - \gamma(z_3 - z_2) = p_a - \rho g(L + H) \quad \text{Ans.}$$

**3.170** If losses are neglected in Fig. P3.170, for what water level  $h$  will the flow begin to form vapor cavities at the throat of the nozzle?

**Solution:** Applying Bernoulli from (a) to (2) gives Torricelli's relation:  $V_2 = \sqrt{2gh}$ . Also,

$$V_1 = V_2(D_2/D_1)^2 = V_2(8/5)^2 = 2.56V_2$$

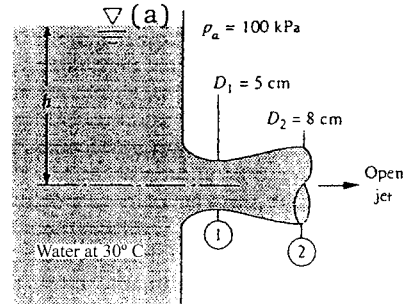


Fig. P3.170

Vapor bubbles form when  $p_1$  reaches the vapor pressure at  $30^\circ\text{C}$ ,  $p_{\text{vap}} \approx 4242 \text{ Pa}$  (from Table A.5), while  $\rho \approx 996 \text{ kg/m}^3$  at  $30^\circ\text{C}$  (Table A.1). Apply Bernoulli between 1 and 2:

$$\frac{p_1}{\rho} + \frac{V_1^2}{2} + gz_1 \approx \frac{p_2}{\rho} + \frac{V_2^2}{2} + gz_2, \quad \text{or: } \frac{4242}{996} + \frac{(2.56V_2)^2}{2} + 0 \approx \frac{100000}{996} + \frac{V_2^2}{2} + 0$$

$$\text{Solve for } V_2^2 = 34.62 = 2gh, \quad \text{or } h = 34.62/[2(9.81)] \approx \mathbf{1.76 \text{ m}} \quad \text{Ans.}$$

**3.171** For the  $40^\circ\text{C}$  water flow in Fig. P3.171, estimate the volume flow through the pipe, assuming no losses; then explain what is wrong with this seemingly innocent question. If the actual flow rate is  $Q = 40 \text{ m}^3/\text{h}$ , compute (a) the head loss in ft and (b) the constriction diameter  $D$  which causes cavitation, assuming that the throat divides the head loss equally and that changing the constriction causes no additional losses.

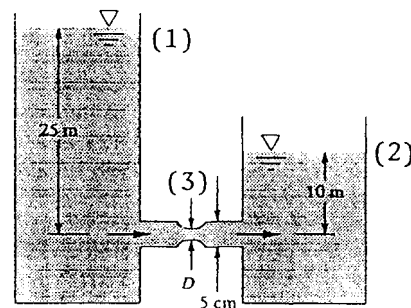


Fig. P3.171

**Solution:** Apply Bernoulli between 1 and 2:

$$\frac{p_1}{\gamma} + \frac{V_1^2}{2g} + z_1 \approx \frac{p_2}{\gamma} + \frac{V_2^2}{2g} + z_2, \quad \text{or: } 0 + 0 + 25 \approx 0 + 0 + 10, \quad \text{or: } \mathbf{25 = 10 ??}$$

This is madness, what happened? The answer is that this problem cannot be free of losses. There is a 15-m loss as the pipe-exit jet dissipates into the downstream reservoir. *Ans.* (a) (b) Examining analysis (a) shows that the head loss is 15 meters. For water at 40°C, the vapor pressure is 7375 Pa (Table A.5), and the density is 992 kg/m<sup>3</sup> (Table A.1). Now write Bernoulli between (1) and (3), assuming a head loss of 15/2 = 7.5 m:

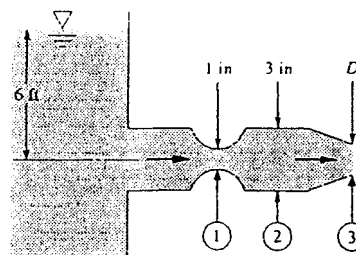
$$\frac{p_1}{\rho} + \frac{V_1^2}{2} + gz_1 = \frac{p_3}{\rho} + \frac{V_3^2}{2} + gz_3 + \frac{g}{2} h_{f,\text{total}}, \quad \text{where } V_3 = \frac{Q}{A_3} = \frac{40/3600}{(\pi/4)D^2} = \frac{0.0141}{D^2}$$

$$\text{Thus } \frac{101350}{992} + 0 + 9.81(25) \approx \frac{7375}{992} + \frac{(0.0141/D^2)^2}{2} + 0 + (9.81)(7.5)$$

$$\text{Solve for } D^4 \approx 3.75\text{E-}7 \text{ m}^4, \quad \text{or } D \approx \mathbf{0.0248 \text{ m} \approx 25 \text{ mm}} \quad \textit{Ans.}$$

This corresponds to  $V_3 \approx 23 \text{ m/s}$ .

**3.172** The 35°C water flow of Fig. P3.172 discharges to sea-level standard atmosphere. Neglecting losses, for what nozzle diameter  $D$  will cavitation begin to occur? To avoid cavitation, should you increase or decrease  $D$  from this critical value?



**Fig. P3.172**

**Solution:** At 35°C the vapor pressure of water is approximately 5600 Pa (Table A.5). Bernoulli from the surface to point 3 gives the Torricelli result  $V_3 = \sqrt{2gh} = \sqrt{2(32.2)(6)} \approx 19.66 \text{ ft/s}$ . We can ignore section 2 and write Bernoulli from (1) to (3), with  $p_1 = p_{\text{vap}}$  and  $\Delta z = 0$ :

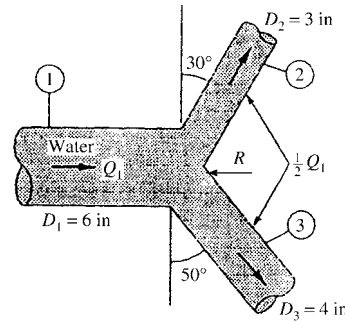
$$\frac{p_1}{\rho} + \frac{V_1^2}{2} \approx \frac{p_2}{\rho} + \frac{V_2^2}{2}, \quad \text{or: } \frac{117}{1.93} + \frac{V_1^2}{2} \approx \frac{2116}{1.93} + \frac{V_3^2}{2},$$

$$\text{but also } V_1 = V_3 \left( \frac{D}{1/12} \right)^2$$

Eliminate  $V_1$  and introduce  $V_3 = 19.66 \frac{\text{ft}}{\text{s}}$  to obtain  $D^4 = 3.07\text{E-}4$ ,  $\mathbf{D \approx 0.132 \text{ ft}}$  *Ans.*

To avoid cavitation, we would keep  $\mathbf{D < 0.132 \text{ ft}}$ , which will keep  $p_1 > p_{\text{vapor}}$ .

**3.173** The horizontal wye fitting in Fig. P3.173 splits the 20°C water flow rate equally, if  $Q_1 = 5 \text{ ft}^3/\text{s}$  and  $p_1 = 25 \text{ lbf/in}^2$  (gage) and losses are neglected, estimate (a)  $p_2$ , (b)  $p_3$ , and (c) the vector force required to keep the wye in place.



**Fig. P3.173**

$$V_1 = \frac{Q}{A_1} = \frac{5.0}{(\pi/4)(6/12)^2} = 25.46 \frac{\text{ft}}{\text{s}}; \quad V_2 = \frac{2.5}{(\pi/4)(3/12)^2} = 50.93 \frac{\text{ft}}{\text{s}}, \quad V_3 = 28.65 \frac{\text{ft}}{\text{s}}$$

Then apply Bernoulli from 1 to 2 and then again from 1 to 3, assuming  $\Delta z \approx 0$ :

$$p_2 = p_1 + \frac{\rho}{2}(V_1^2 - V_2^2) = 25(144) + \frac{1.94}{2}[(25.46)^2 - (50.93)^2] \approx \mathbf{1713 \text{ psfg}} \quad \text{Ans. (a)}$$

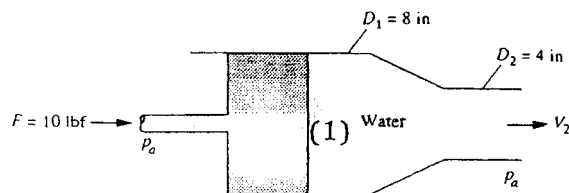
$$p_3 = p_1 + \frac{\rho}{2}(V_1^2 - V_3^2) = 25(144) + \frac{1.94}{2}[(25.46)^2 - (28.65)^2] \approx \mathbf{3433 \text{ psfg}} \quad \text{Ans. (b)}$$

(c) to compute the support force  $\mathbf{R}$  (see figure above), put a CV around the entire wye:

$$\begin{aligned} \sum F_x &= R_x + p_1 A_1 - p_2 A_2 \sin 30^\circ - p_3 A_3 \sin 50^\circ = \rho Q_2 V_2 \sin 30^\circ + \rho Q_3 V_3 \sin 50^\circ - \rho Q_1 V_1 \\ &= R_x + 707 - 42 - 229 = 124 + 106 - 247, \quad \text{or: } R_x = \mathbf{-453 \text{ lbf}} \quad (\text{to left}) \quad \text{Ans. (c)} \end{aligned}$$

$$\begin{aligned} \sum F_y &= R_y - p_2 A_2 \cos 30^\circ + p_3 A_3 \cos 50^\circ = \rho Q_2 V_2 \cos 30^\circ + \rho Q_3 (-V_3) \cos 50^\circ \\ &= R_y - 73 + 193 = 214 - 89, \quad \text{or: } R_y \approx \mathbf{+5 \text{ lbf}} \quad (\text{up}) \quad \text{Ans. (c)} \end{aligned}$$

**3.174** In Fig. P3.174 the piston drives water at 20°C. Neglecting losses, estimate the exit velocity  $V_2$  ft/s. If  $D_2$  is further constricted, what is the maximum possible value of  $V_2$ ?



**Fig. P3.174**

**Solution:** Find  $p_1$  from a freebody of the piston:

$$\sum F_x = F + p_a A_1 - p_1 A_1, \quad \text{or: } p_1 - p_a = \frac{10.0 \text{ lbf}}{(\pi/4)(8/12)^2} \approx 28.65 \frac{\text{lbf}}{\text{ft}^2}$$

Now apply continuity and Bernoulli from 1 to 2:

$$V_1 A_1 = V_2 A_2, \quad \text{or} \quad V_1 = \frac{1}{4} V_2; \quad \frac{p_1}{\rho} + \frac{V_1^2}{2} \approx \frac{p_a}{\rho} + \frac{V_2^2}{2}$$

Introduce  $p_1 - p_a$  and substitute for  $V_1$  to obtain  $V_2^2 = \frac{2(28.65)}{1.94(1-1/16)},$

$$V_2 = 5.61 \frac{\text{ft}}{\text{s}} \quad \text{Ans.}$$

If we reduce section 2 to a pinhole,  $V_2$  will drop off slowly until  $V_1$  vanishes:

Severely constricted section 2:  $V_2 = \sqrt{\frac{2(28.65)}{1.94(1-0)}} \approx 5.43 \frac{\text{ft}}{\text{s}} \quad \text{Ans.}$

**3.175** If the approach velocity is not too high, a hump in the bottom of a water channel causes a dip  $\Delta h$  in the water level, which can serve as a flow measurement. If, as shown in Fig. P3.175,  $\Delta h = 10$  cm when the bump is 30 cm high, what is the volume flow  $Q_1$  per unit width, assuming no losses? In general, is  $\Delta h$  proportional to  $Q_1$ ?

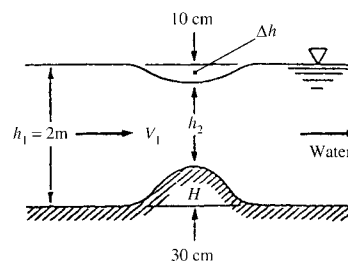


Fig. P3.175

**Solution:** Apply continuity and Bernoulli between 1 and 2:

$$V_1 h_1 = V_2 h_2; \quad \frac{V_1^2}{2g} + h_1 \approx \frac{V_2^2}{2g} + h_2 + H, \quad \text{solve} \quad V_1^2 \approx \frac{2g\Delta h}{(h_1^2/h_2^2) - 1} \quad \text{Ans.}$$

We see that  $\Delta h$  is proportional to the square of  $V_1$  (or  $Q_1$ ), not the first power. For the given numerical data, we may compute the approach velocity:

$$h_2 = 2.0 - 0.3 - 0.1 = 1.6 \text{ m}; \quad V_1 = \sqrt{\frac{2(9.81)(0.1)}{[(2.0/1.6)^2 - 1]}} = 1.87 \frac{\text{m}}{\text{s}}$$

whence  $Q_1 = V_1 h_1 = (1.87)(2.0) \approx 3.74 \frac{\text{m}^3}{\text{s} \cdot \text{m}} \quad \text{Ans.}$

**3.176** In the spillway flow of Fig. P3.176, the flow is assumed uniform and hydrostatic at sections 1 and 2. If losses are neglected, compute (a)  $V_2$  and (b) the force per unit width of the water on the spillway.

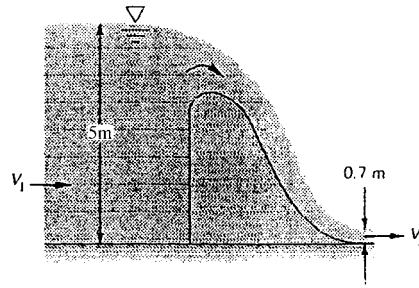


Fig. P3.176

**Solution:** For mass conservation,

$$V_2 = V_1 h_1 / h_2 = \frac{5.0}{0.7} V_1 = 7.14 V_1$$

(a) Now apply Bernoulli from 1 to 2:

$$\frac{p_1}{\gamma} + \frac{V_1^2}{2g} + h_1 \approx \frac{p_2}{\gamma} + \frac{V_2^2}{2g} + h_2; \quad \text{or:} \quad 0 + \frac{V_1^2}{2g} + 5.0 \approx 0 + \frac{(7.14V_1)^2}{2g} + 0.7$$

$$\text{Solve for } V_1^2 = \frac{2(9.81)(5.0 - 0.7)}{[(7.14)^2 - 1]}, \quad \text{or } V_1 = \mathbf{1.30 \frac{m}{s}}, \quad V_2 = 7.14V_1 = \mathbf{9.28 \frac{m}{s}} \quad \text{Ans. (a)}$$

(b) To find the force on the spillway ( $F \leftarrow$ ), put a CV around sections 1 and 2 to obtain

$$\sum F_x = -F + \frac{\gamma}{2} h_1^2 - \frac{\gamma}{2} h_2^2 = \dot{m}(V_2 - V_1), \quad \text{or, using the given data,}$$

$$F = \frac{1}{2}(9790)[(5.0)^2 - (0.7)^2] - 998[(1.30)(5.0)](9.28 - 1.30) \approx \mathbf{68300 \frac{N}{m}} \quad \text{Ans. (b)}$$

**3.177** For the water-channel flow of Fig. P3.177,  $h_1 = 1.5$  m,  $H = 4$  m, and  $V_1 = 3$  m/s. Neglecting losses and assuming uniform flow at sections 1 and 2, find the downstream depth  $h_2$ , and show that *two* realistic solutions are possible.

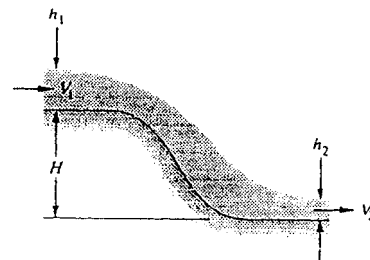


Fig. P3.177

**Solution:** Combine continuity and Bernoulli between 1 and 2:

$$V_2 = V_1 \frac{h_1}{h_2} = \frac{3(1.5)}{h_2}; \quad \frac{V_1^2}{2g} + h_1 + H \approx \frac{V_2^2}{2g} + h_2 = \frac{V_1^2}{2(9.81)} + 1.5 + 4 \approx \frac{(4.5/h_2)^2}{2(9.81)} + h_2$$

Combine into a cubic equation:  $h_2^3 - 5.959 h_2^2 + 1.032 = 0$ . The three roots are:

$$h_2 = -0.403 \text{ m (impossible); } h_2 = +5.93 \text{ m (subcritical);}$$

$$h_2 = +0.432 \text{ m (supercritical) } \textit{Ans.}$$

**3.178** For the water channel flow of Fig. P3.178,  $h_1 = 0.45$  ft,  $H = 2.2$  ft, and  $V_1 = 16$  ft/s. Neglecting losses and assuming uniform flow at sections 1 and 2, find the downstream depth  $h_2$ . Show that *two* realistic solutions are possible.

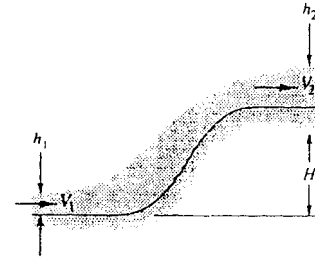


Fig. P3.178

**Solution:** The analysis is quite similar to Prob. 3.177 - continuity + Bernoulli:

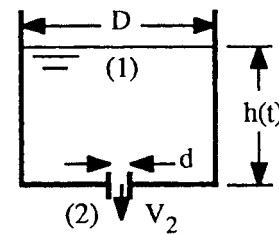
$$V_2 = V_1 \frac{h_1}{h_2} = \frac{16(0.45)}{h_2}; \quad \frac{V_1^2}{2g} + h_1 = \frac{V_2^2}{2g} + h_2 + H = \frac{V_1^2}{2(32.2)} + 0.45 = \frac{(7.2/h_2)^2}{2(32.2)} + h_2 + 2.2$$

Combine into a cubic equation:  $h_2^3 - 2.225 h_2^2 + 0.805 = 0$ . The three roots are:

$$h_2 = -0.540 \text{ ft (impossible); } h_2 = +2.03 \text{ ft (subcritical);}$$

$$h_2 = +0.735 \text{ ft (supercritical) } \textit{Ans.}$$

**3.179** A cylindrical tank of diameter  $D$  contains liquid to an initial height  $h_0$ . At time  $t = 0$  a small stopper of diameter  $d$  is removed from the bottom. Using Bernoulli's equation with no losses, derive (a) a differential equation for the free-surface height  $h(t)$  during draining and (b) an expression for the time  $t_0$  to drain the entire tank.



**Solution:** Write continuity and the unsteady Bernoulli relation from 1 to 2:

$$\int_1^2 \frac{\partial V}{\partial t} ds + \frac{p_2}{\rho} + \frac{V_2^2}{2} + gz_2 = \frac{p_1}{\rho} + \frac{V_1^2}{2} + gz_1; \quad \text{Continuity: } V_2 = V_1 \frac{A_1}{A_2} = V_1 \left( \frac{D}{d} \right)^2$$

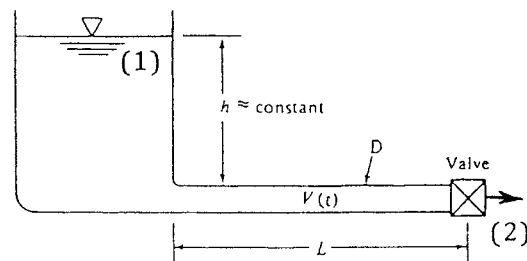
The integral term  $\int \frac{\partial V}{\partial t} ds \approx \frac{dV_1}{dt} h$  is very small and will be neglected, and  $p_1 = p_2$ . Then

$V_1 \approx \left[ \frac{2gh}{\alpha - 1} \right]^{1/2}$ , where  $\alpha = (D/d)^4$ ; but also  $V_1 = -\frac{dh}{dt}$ , separate and integrate:

$$\int_{h_0}^h \frac{dh}{h^{1/2}} = - \left[ \frac{2g}{\alpha - 1} \right]^{1/2} \int_0^t dt, \quad \text{or: } \mathbf{h} = \left[ \mathbf{h_0^{1/2}} - \left\{ \frac{\mathbf{g}}{2(\alpha - 1)} \right\}^{1/2} \mathbf{t} \right]^2, \quad \alpha = \left( \frac{D}{d} \right)^4 \quad \text{Ans. (a)}$$

(b) the tank is empty when  $h = 0$  in (a) above, or  $\mathbf{t_{final}} = [2(\alpha - 1)g/h_0]^{1/2}$ . *Ans. (b)*

**3.180** The large tank of incompressible liquid in Fig. P3.180 is at rest when, at  $t = 0$ , the valve is opened to the atmosphere. Assuming  $h \approx \text{constant}$  (negligible velocities and accelerations in the tank), use the unsteady frictionless Bernoulli equation to derive and solve a differential equation for  $V(t)$  in the pipe.



**Fig. P3.180**

**Solution:** Write unsteady Bernoulli from 1 to 2:

$$\int_1^2 \frac{\partial V}{\partial t} ds + \frac{V_2^2}{2} + gz_2 \approx \frac{V_1^2}{2} + gz_1, \quad \text{where } p_1 = p_2, \quad V_1 \approx 0, \quad z_2 \approx 0, \quad \text{and } z_1 = h = \text{const}$$

The integral approximately equals  $\frac{dV}{dt}L$ , so the diff. eqn. is  $2L \frac{dV}{dt} + V^2 = 2gh$

This first-order ordinary differential equation has an exact solution for  $V = 0$  at  $t = 0$ :

$$\mathbf{V} = \mathbf{V_{final}} \tanh \left( \frac{\mathbf{V_{final} t}}{2\mathbf{L}} \right), \quad \text{where } \mathbf{V_{final}} = \sqrt{2\mathbf{gh}} \quad \text{Ans.}$$

**3.181** Modify Prob. 3.180 as follows. Let the top of the tank be enclosed and under constant gage pressure  $p_0$ . Repeat the analysis to find  $V(t)$  in the pipe.



**Solution:** The analysis is the same as Prob. 3.180, except that we now have a (constant) surface-pressure term at point 1 which contributes to  $V_{\text{final}}$ :

$$\int_1^2 \frac{\partial V}{\partial t} ds + \frac{V_2^2}{2} + gz_2 \approx \frac{p_o}{\rho} + \frac{V_1^2}{2} + gz_1 = \frac{dV}{dt}L + \frac{V^2}{2} = \frac{p_o}{\rho} + gh, \quad \text{with } V = 0 \text{ at } t = 0.$$

The solution is:  $V = V_{\text{final}} \tanh\left(\frac{V_{\text{final}} t}{2L}\right)$ , where  $V_{\text{final}} = \sqrt{\frac{2p_o}{\rho} + 2gh}$  Ans.

---

**3.182** The incompressible-flow form of Bernoulli's relation, Eq. (3.77), is accurate only for Mach numbers less than about 0.3. At higher speeds, variable density must be accounted for. The most common assumption for compressible fluids is *isentropic flow of an ideal gas*, or  $p = C\rho^k$ , where  $k = c_p/c_v$ . Substitute this relation into Eq. (3.75), integrate, and eliminate the constant  $C$ . Compare your compressible result with Eq. (3.77) and comment.

**Solution:** We are to integrate the differential Bernoulli relation with variable density:

$$p = C\rho^k, \quad \text{so} \quad dp = kC\rho^{k-1} d\rho, \quad k = c_p/c_v$$

Substitute this into the Bernoulli relation:

$$\frac{dp}{\rho} + V dV + g dz = \frac{kC\rho^{k-1} d\rho}{\rho} + V dV + g dz = 0$$

$$\text{Integrate: } \int kC\rho^{k-2} d\rho + \int V dV + \int g dz = \int 0 = \text{constant}$$

The first integral equals  $kC\rho^{k-1}/(k-1) = kp/[\rho(k-1)]$  from the isentropic relation. Thus the compressible isentropic Bernoulli relation can be written in the form

$$\frac{kp}{(k-1)\rho} + \frac{V^2}{2} + gz = \text{constant} \quad \text{Ans.}$$

It looks quite different from the incompressible relation, which only has “ $p/\rho$ .” It becomes more clear when we make the ideal-gas substitution  $p/\rho = RT$  and  $c_p = kR/(k-1)$ . Then we obtain the equivalent of the adiabatic, no-shaft-work energy equation:

$$c_p T + \frac{V^2}{2} + gz = \text{constant} \quad \text{Ans.}$$


---

**3.183** The pump in Fig. P3.183 draws gasoline at 20°C from a reservoir. Pumps are in big trouble if the liquid vaporizes (cavitates) before it enters the pump. (a) Neglecting losses and assuming a flow rate of 65 gal/min, find the limitations on  $(x, y, z)$  for avoiding cavitation. (b) If pipe-friction losses are included, what additional limitations might be important?

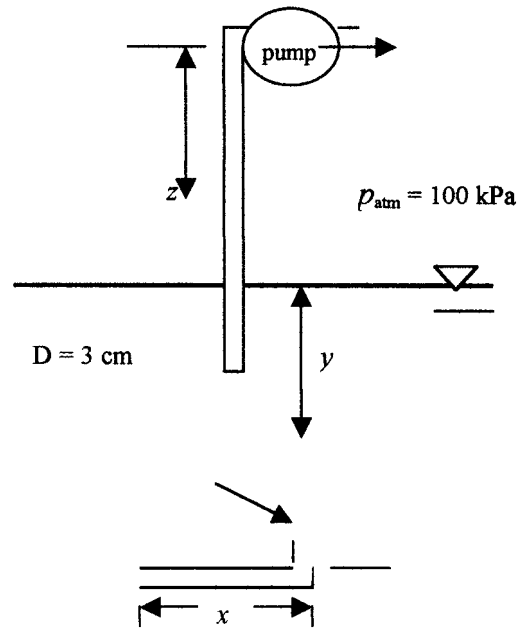


Fig. P3.183

**Solution:** (a) From Table A.3,  $\rho = 680 \text{ kg/m}^3$  and  $p_v = 5.51\text{E}+4$ .

$$z_2 - z_1 = y + z = \frac{p_1 - p_2}{\rho g} = \frac{(p_a + \rho g y) - p_v}{\rho g}$$

$$y + z = \frac{(100,000 - 55,100)}{(680)(9.81)} + y \quad z = 6.73 \text{ m}$$

Thus make length  $z$  appreciably less than 6.73 (25% less), or  $z < 5 \text{ m}$ . *Ans. (a)*

(b) **Total pipe length  $(x + y + z)$  restricted by friction losses.** *Ans. (b)*

**3.184** For the system of Prob. 3.183, let the pump exhaust gasoline at 65 gal/min to the atmosphere through a 3-cm-diameter opening, with no cavitation, when  $x = 3 \text{ m}$ ,  $y = 2.5 \text{ m}$ , and  $z = 2 \text{ m}$ . If the friction head loss is  $h_{\text{loss}} \approx 3.7(V^2/2g)$ , where  $V$  is the average velocity in the pipe, estimate the horsepower required to be delivered by the pump.

**Solution:** Since power is a function of  $h_p$ , Bernoulli is required. Thus calculate the velocity,

$$V = \frac{Q}{A} = \frac{(65 \text{ gal/min}) \left( 6.3083\text{E}-5 \frac{\text{m}^3/\text{s}}{\text{gal/min}} \right)}{\frac{\pi}{4} (0.03^2)} = 5.8 \text{ m/s}$$

The pump head may then be found,

$$\frac{p_1}{\gamma} + z_1 = \frac{p_2}{\gamma} + z_2 + h_f - h_p + \frac{V_j^2}{2g}$$

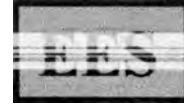
$$\frac{100,000 + (680)(9.81)(2.5)}{(680)(9.81)} - 2.5 = \frac{100,000}{(680)(9.81)} + 2 + \frac{3.7(5.8^2)}{2(9.81)} - h_p + \frac{(5.8^2)}{2(9.81)}$$

$$h_p = 10.05 \text{ m}$$

$$P = \gamma Q h_p = (680)(9.81)(0.0041)(10.05) \quad \mathbf{P = 275 \text{ W} = 0.37 \text{ hp}} \quad \text{Ans.}$$


---

**3.185** Water at 20°C flows through a vertical tapered pipe at 163 m<sup>3</sup>/h. The entrance diameter is 12 cm, and the pipe diameter reduces by 3 mm for every 2 meter rise in elevation. For frictionless flow, if the entrance pressure is 400 kPa, at what elevation will the fluid pressure be 100 kPa?



**Solution:** Bernoulli's relation applies,

$$\frac{p_1}{\gamma} + z_1 + \frac{Q_1^2}{2gA_1^2} = \frac{p_2}{\gamma} + z_2 + \frac{Q_2^2}{2gA_2^2} \quad (1)$$

Where,

$$d_2 = d_1 - 0.0015(z_2 - z_1) \quad (2)$$

Also,  $Q_1 = Q_2 = Q = (163 \text{ m}^3/\text{h})(\text{h}/3600\text{s}) = 0.0453 \text{ m}^3/\text{s}$ ;  $\gamma = 9790$ ;  $z_1 = 0.0$ ;  $p_1 = 400,000$ ; and  $p_2 = 100,000$ . Using EES software to solve equations (1) and (2) simultaneously, the final height is found to be  $z \approx \mathbf{27.2 \text{ m}}$ . The pipe diameter at this elevation is  $d_2 = 0.079 \text{ m} = 7.9 \text{ cm}$ .

---

**FUNDAMENTALS OF ENGINEERING EXAM PROBLEMS: Answers**

FE3.1 In Fig. FE3.1 water exits from a nozzle into atmospheric pressure of 101 kPa. If the flow rate is 160 gal/min, what is the average velocity at section 1?

- (a) **2.6 m/s** (b) 0.81 m/s (c) 93 m/s (d) 23 m/s (e) 1.62 m/s

FE3.2 In Fig. FE3.1 water exits from a nozzle into atmospheric pressure of 101 kPa. If the flow rate is 160 gal/min and friction is neglected, what is the gage pressure at section 1?

- (a) 1.4 kPa (b) 32 kPa (c) 43 kPa (d) **22 kPa** (e) 123 kPa

FE3.3 In Fig. FE3.1 water exits from a nozzle into atmospheric pressure of 101 kPa. If the exit velocity is  $V_2 = 8$  m/s and friction is neglected, what is the axial flange force required to keep the nozzle attached to pipe 1?

- (a) 11 N (b) **36 N** (c) 83 N (d) 123 N (e) 110 N

FE3.4 In Fig. FE3.1 water exits from a nozzle into atmospheric pressure of 101 kPa. If the manometer fluid has a specific gravity of 1.6 and  $h = 66$  cm, with friction neglected, what is the average velocity at section 2?

- (a) 4.55 m/s (b) 2.4 m/s (c) **2.8 m/s** (d) 5.55 m/s (e) 3.4 m/s

FE3.5 A jet of water 3 cm in diameter strikes normal to a plate as in Fig. FE3.5. If the force required to hold the plate is 23 N, what is the jet velocity?

- (a) 2.85 m/s (b) **5.7 m/s** (c) 8.1 m/s (d) 4.0 m/s (e) 23 m/s

FE3.6 A fireboat pump delivers water to a vertical nozzle with a 3:1 diameter ratio, as in Fig. FE3.6. If friction is neglected and the flow rate is 500 gal/min, how high will the outlet water jet rise?

- (a) 2.0 m (b) 9.8 m (c) **32 m** (d) 64 m (e) 98 m

FE3.7 A fireboat pump delivers water to a vertical nozzle with a 3:1 diameter ratio, as in Fig. FE3.6. If friction is neglected and the pump increases the pressure at section 1 to 51 kPa (gage), what will be the resulting flow rate?

- (a) **187 gal/min** (b) 199 gal/min (c) 214 gal/min (d) 359 gal/min (e) 141 gal/min

FE3.8 A fireboat pump delivers water to a vertical nozzle with a 3:1 diameter ratio, as in Fig. FE3.6. If duct and nozzle friction are neglected and the pump provides 12.3 feet of head to the flow, what will be the outlet flow rate?

- (a) 85 gal/min (b) 120 gal/min (c) **154 gal/min** (d) 217 gal/min (e) 285 gal/min

FE3.9 Water flowing in a smooth 6-cm-diameter pipe enters a venturi contraction with a throat diameter of 3 cm. Upstream pressure is 120 kPa. If cavitation occurs in the throat at a flow rate of 155 gal/min, what is the estimated fluid vapor pressure, assuming ideal frictionless flow?

- (a) 6 kPa (b) 12 kPa (c) 24 kPa (d) **31 kPa** (e) 52 kPa

FE3.10 Water flowing in a smooth 6-cm-diameter pipe enters a venturi contraction with a throat diameter of 4 cm. Upstream pressure is 120 kPa. If the pressure in the throat is 50 kPa, what is the flow rate, assuming ideal frictionless flow?

- (a) 7.5 gal/min (b) 236 gal/min (c) **263 gal/min** (d) 745 gal/min (e) 1053 gal/min

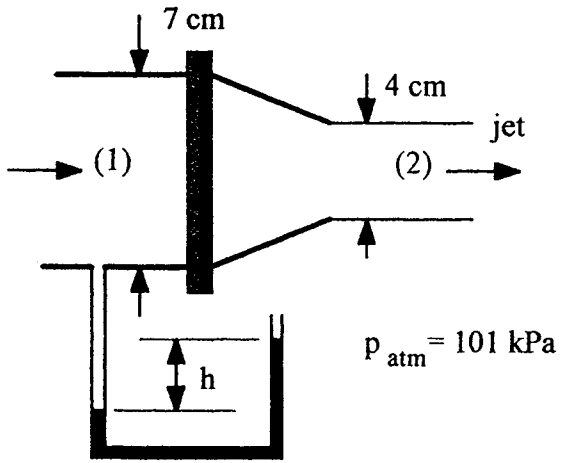


Fig. FE3.1

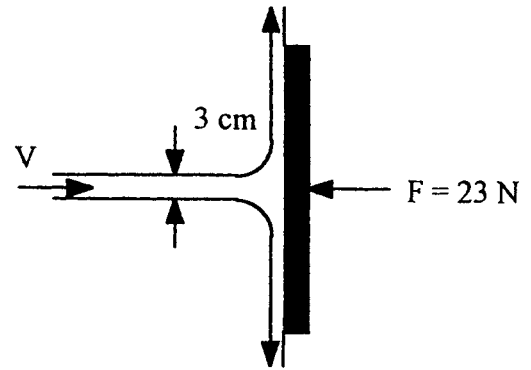


Fig. FE3.5

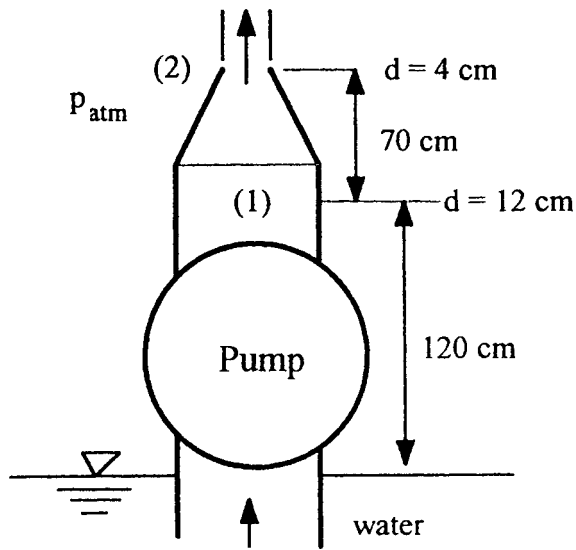
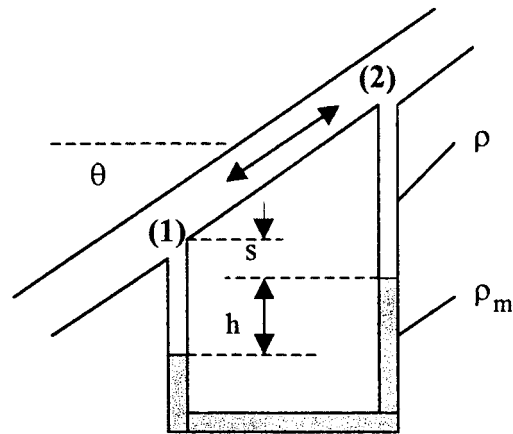


Fig. FE3.6

## COMPREHENSIVE PROBLEMS

**C3.1** In a certain industrial process, oil of density  $\rho$  flows through the inclined pipe in the figure. A U-tube manometer with fluid density  $\rho_m$ , measures the pressure difference between points 1 and 2, as shown. The flow is steady, so that fluids in the U-tube are stationary. (a) Find an analytic expression for  $p_1 - p_2$  in terms of system parameters. (b) Discuss the conditions on  $h$  necessary for there to be no flow in the pipe. (c) What about flow *up*, from 1 to 2? (d) What about flow *down*, from 2 to 1?



**Solution:** (a) Start at 1 and work your way around the U-tube to point 2:

$$p_1 + \rho g s + \rho g h - \rho_m g h - \rho g s - \rho g \Delta z = p_2,$$

$$\text{or: } p_1 - p_2 = \rho g \Delta z + (\rho_m - \rho) g h \quad \text{where } \Delta z = z_2 - z_1 \quad \text{Ans. (a)}$$

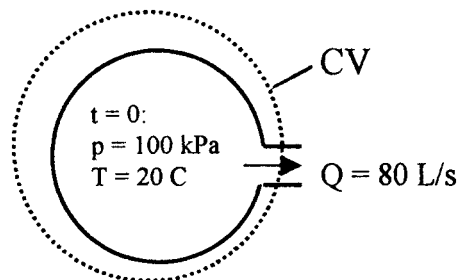
(b) If there is no flow, the pressure is entirely hydrostatic, therefore  $\Delta p = \rho g$  and, since  $\rho_m \neq \rho$ , it follows from Ans. (a) above that  $h = 0$  Ans. (b)

(c) If  $h$  is positive (as in the figure above),  $p_1$  is greater than it would be for no flow, because of head losses in the pipe. **Thus, if  $h > 0$ , flow is up from 1 to 2.** Ans. (c)

(d) If  $h$  is negative,  $p_1$  is less than it would be for no flow, because the head losses act against hydrostatics. **Thus, if  $h < 0$ , flow is down from 2 to 1.** Ans. (d)

Note that  $h$  is a direct measure of flow, regardless of the angle  $\theta$  of the pipe.

**C3.2** A rigid tank of volume  $v = 1.0 \text{ m}^3$  is initially filled with air at  $20^\circ\text{C}$  and  $p_0 = 100 \text{ kPa}$ . At time  $t = 0$ , a vacuum pump is turned on and evacuates air at a constant volume flow rate  $Q = 80 \text{ L/min}$  (regardless of the pressure). Assume an ideal gas and an isothermal process. (a) Set up a differential equation for this flow. (b) Solve this equation for  $t$  as a function of  $(v, Q, p, p_0)$ . (c) Compute the time in minutes to pump the tank down to  $p = 20 \text{ kPa}$ . [Hint: Your answer should lie between 15 and 25 minutes.]



**Solution:** The control volume encloses the tank, as shown. The CV mass flow relation becomes

$$\frac{d}{dt} \left( \int \rho dv \right) + \sum \dot{m}_{out} - \sum \dot{m}_{in} = 0$$

Assuming that  $\rho$  is constant throughout the tank, the integral equals  $\rho v$ , and we obtain

$$v \frac{d\rho}{dt} + \rho Q = 0, \quad \text{or:} \quad \int \frac{d\rho}{\rho} = -\frac{Q}{v} \int dt, \quad \text{yielding} \quad \ln \left( \frac{\rho}{\rho_o} \right) = -\frac{Qt}{v}$$

Where  $\rho_o$  is the initial density. But, for an isothermal ideal gas,  $\rho/\rho_o = p/p_o$ . Thus the time required to pump the tank down to pressure  $p$  is given by

$$t = -\frac{v}{Q} \ln \left( \frac{p}{p_o} \right) \quad \text{Ans. (a, b)}$$

(c) For our particular numbers, noting  $Q = 80 \text{ L/min} = 0.080 \text{ m}^3/\text{min}$ , the time to pump a  $1 \text{ m}^3$  tank down from 100 to 20 kPa is

$$t = -\frac{1.0 \text{ m}^3}{0.08 \text{ m}^3/\text{min}} \ln \left( \frac{20}{100} \right) = \mathbf{20.1 \text{ min}} \quad \text{Ans. (c)}$$

**C3.3** Suppose the same steady water jet as in Prob. 3.40 (jet velocity 8 m/s and jet diameter 10 cm) impinges instead on a cup cavity as shown in the figure. The water is turned 180° and exits, due to friction, at lower velocity,  $V_e = 4 \text{ m/s}$ . (Looking from the left, the exit jet is a circular annulus of outer radius  $R$  and thickness  $h$ , flowing toward the viewer.) The cup has a radius of curvature of 25 cm. Find (a) the thickness  $h$  of the exit jet, and (b) the force  $F$  required to hold the cupped object in place. (c) Compare part (b) to Prob. 3.40, where  $F = 500 \text{ N}$ , and give a physical explanation as to why  $F$  has changed.

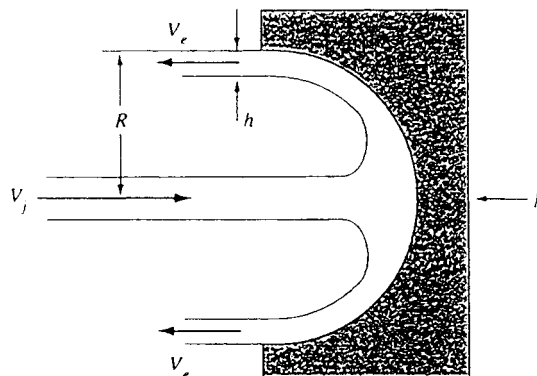


Fig. C3.3

**Solution:** For a steady-flow control volume enclosing the block and cutting through the jets, we obtain  $\sum Q_{in} = \sum Q_{out}$ , or:

$$V_j \frac{\pi}{4} D_j^2 = V_e \pi [R^2 - (R-h)^2], \quad \text{or:} \quad h = R - \sqrt{R^2 - \frac{V_j D_j^2}{V_e}} \quad \text{Ans. (a)}$$

For our particular numbers,

$$h = 0.25 - \sqrt{(0.25)^2 - \frac{8}{4} \frac{(0.1)^2}{4}} = 0.25 - 0.2398 = 0.0102 \text{ m} = \mathbf{1.02 \text{ cm}} \quad \text{Ans. (a)}$$

(b) Use the momentum relation, assuming no net pressure force except for  $F$ :

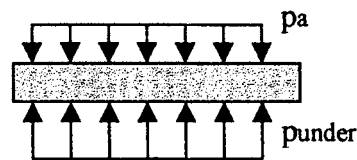
$$\sum F_x = -F = \dot{m}_{jet}(-V_e) - \dot{m}_{jet}(V_j), \quad \text{or: } \mathbf{F = \rho V_j \frac{\pi}{4} D_j^2 (V_j + V_e)} \quad \text{Ans. (b)}$$

For our particular numbers:

$$F = 998(8) \frac{\pi}{4} (0.1)^2 (8 + 4) = \mathbf{752 \text{ N to the left}} \quad \text{Ans. (b)}$$

(c) The answer to Prob. 3.40 was 502 N. We get **50% more** because we turned through  $180^\circ$ , not  $90^\circ$ . *Ans. (c)*

**C3.4** The air flow beneath an air hockey puck is very complex, especially since the air jets from the table impinge on the puck at various points asymmetrically. A reasonable approximation is that, at any given time, the



gauge pressure on the bottom of the puck is halfway between zero (atmospheric) and the stagnation pressure of the impinging jets,  $p_o = 1/2 \rho V_{jet}^2$ . (a) Find the velocity  $V_{jet}$  required to support a puck of weight  $W$  and diameter  $d$ , with air density  $\rho$  as a parameter. (b) For  $W = 0.05 \text{ lbf}$  and  $d = 2.5 \text{ inches}$ , estimate the required jet velocity in  $\text{ft/s}$ .

**Solution:** (a) The puck has atmospheric pressure on the top and slightly higher on the bottom:

$$(p_{under} - p_a)A_{puck} = W = \frac{1}{2} \left( 0 + \frac{\rho}{2} V_{jet}^2 \right) \frac{\pi}{4} d^2, \quad \text{Solve for } \mathbf{V_{jet} = \frac{4}{d} \sqrt{\frac{W}{\pi \rho}}} \quad \text{Ans. (a)}$$

For our particular numbers,  $W = 0.05 \text{ lbf}$  and  $d = 2.5 \text{ inches}$ , we assume sea-level air,  $\rho = 0.00237 \text{ slug/ft}^3$ , and obtain

$$V_{jet} = \frac{4}{(2.5/12 \text{ ft})} \sqrt{\frac{0.05 \text{ lbf}}{\pi(0.00237 \text{ slug/ft}^3)}} = \mathbf{50 \text{ ft/s}} \quad \text{Ans. (b)}$$



**C3.5** Neglecting friction sometimes leads to odd results. You are asked to analyze and discuss the following example in Fig. C3.5. A fan blows air vertically through a duct from section 1 to section 2, as shown. Assume constant air density  $\rho$ . Neglecting frictional losses, find a relation between the required fan head  $h_p$  and the flow rate and the elevation change. Then explain what may be an unexpected result.

**Solution:** Neglecting frictional losses,  $h_f = 0$ , and Bernoulli becomes,

$$\frac{p_1}{\rho g} + \frac{V_1^2}{2g} + z_1 = \frac{p_2}{\rho g} + z_2 + \frac{V_2^2}{2g} - h_p$$

$$\frac{p_1}{\rho g} + \frac{V_1^2}{2g} + z_1 = \frac{p_2 + \rho g(z_1 - z_2)}{\rho g} + \frac{V_2^2}{2g} + z_2 - h_p$$

Since the fan draws from and exhausts to atmosphere,  $V_1 = V_2 \approx 0$ . Solving for  $h_p$ ,

$$h_p = \rho g(z_1 - z_2) + \rho g z_2 - \rho g z_1 = 0 \quad \text{Ans.}$$

Without friction, and with  $V_1 = V_2$ , the energy equation predicts that  $h_p = 0$ ! Because the air has insignificant weight, as compared to a heavier fluid such as water, the power input required to lift the air is also negligible.

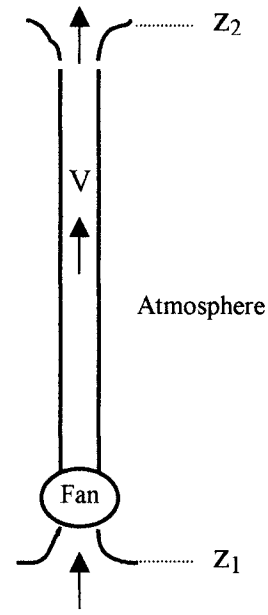


Fig. C3.5

# Chapter 4 • Differential Relations for a Fluid Particle

**4.1** An idealized velocity field is given by the formula

$$\mathbf{V} = 4tx\mathbf{i} - 2t^2y\mathbf{j} + 4xz\mathbf{k}$$

Is this flow field steady or unsteady? Is it two- or three-dimensional? At the point  $(x, y, z) = (-1, +1, 0)$ , compute (a) the acceleration vector and (b) any unit vector normal to the acceleration.

**Solution:** (a) The flow is unsteady because time  $t$  appears explicitly in the components. (b) The flow is three-dimensional because all three velocity components are nonzero. (c) Evaluate, by laborious differentiation, the acceleration vector at  $(x, y, z) = (-1, +1, 0)$ .

$$\frac{du}{dt} = \frac{\partial u}{\partial t} + u \frac{\partial u}{\partial x} + v \frac{\partial u}{\partial y} + w \frac{\partial u}{\partial z} = 4x + 4tx(4t) - 2t^2y(0) + 4xz(0) = 4x + 16t^2x$$

$$\frac{dv}{dt} = \frac{\partial v}{\partial t} + u \frac{\partial v}{\partial x} + v \frac{\partial v}{\partial y} + w \frac{\partial v}{\partial z} = -4ty + 4tx(0) - 2t^2y(-2t^2) + 4xz(0) = -4ty + 4t^4y$$

$$\frac{dw}{dt} = \frac{\partial w}{\partial t} + u \frac{\partial w}{\partial x} + v \frac{\partial w}{\partial y} + w \frac{\partial w}{\partial z} = 0 + 4tx(4z) - 2t^2y(0) + 4xz(4x) = 16txz + 16x^2z$$

$$\text{or: } \frac{d\mathbf{V}}{dt} = (4x + 16t^2x)\mathbf{i} + (-4ty + 4t^4y)\mathbf{j} + (16txz + 16x^2z)\mathbf{k}$$

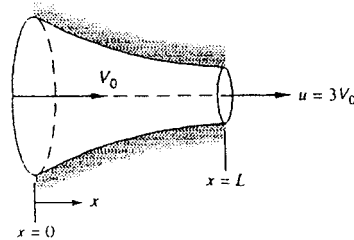
at  $(x, y, z) = (-1, +1, 0)$ , we obtain  $\frac{d\mathbf{V}}{dt} = -4(1 + 4t^2)\mathbf{i} - 4t(1 - t^3)\mathbf{j} + 0\mathbf{k}$  *Ans. (c)*

(d) At  $(-1, +1, 0)$  there are many unit vectors normal to  $d\mathbf{V}/dt$ . One obvious one is  $\mathbf{k}$ . *Ans.*

**4.2** Flow through the converging nozzle in Fig. P4.2 can be approximated by the one-dimensional velocity distribution

$$u \approx V_0 \left( 1 + \frac{2x}{L} \right) \quad v \approx 0 \quad w \approx 0$$

(a) Find a general expression for the fluid acceleration in the nozzle. (b) For the specific case  $V_0 = 10$  ft/s and  $L = 6$  in, compute the acceleration, in  $g$ 's, at the entrance and at the exit.



**Fig. P4.2**

**Solution:** Here we have only the single ‘one-dimensional’ convective acceleration:

$$\frac{du}{dt} = u \frac{\partial u}{\partial x} = \left[ V_o \left( 1 + \frac{2x}{L} \right) \right] \frac{2V_o}{L} = \frac{2V_o^2}{L} \left( 1 + \frac{2x}{L} \right) \quad \text{Ans. (a)}$$

$$\text{For } L = 6'' \text{ and } V_o = 10 \frac{\text{ft}}{\text{s}}, \quad \frac{du}{dt} = \frac{2(10)^2}{6/12} \left( 1 + \frac{2x}{6/12} \right) = 400(1 + 4x), \text{ with } x \text{ in feet}$$

At  $x = 0$ ,  $du/dt = 400 \text{ ft/s}^2$  ( $12 \text{ g's}$ ); at  $x = L = 0.5 \text{ ft}$ ,  $du/dt = 1200 \text{ ft/s}^2$  ( $37 \text{ g's}$ ). *Ans. (b)*

---

**4.3** A two-dimensional velocity field is given by

$$\mathbf{V} = (x^2 - y^2 + x)\mathbf{i} - (2xy + y)\mathbf{j}$$

in arbitrary units. At  $(x, y) = (1, 2)$ , compute (a) the accelerations  $a_x$  and  $a_y$ , (b) the velocity component in the direction  $\theta = 40^\circ$ , (c) the direction of maximum velocity, and (d) the direction of maximum acceleration.

**Solution:** (a) Do each component of acceleration:

$$\frac{du}{dt} = u \frac{\partial u}{\partial x} + v \frac{\partial u}{\partial y} = (x^2 - y^2 + x)(2x + 1) + (-2xy - y)(-2y) = a_x$$

$$\frac{dv}{dt} = u \frac{\partial v}{\partial x} + v \frac{\partial v}{\partial y} = (x^2 - y^2 + x)(-2y) + (-2xy - y)(-2x - 1) = a_y$$

At  $(x, y) = (1, 2)$ , we obtain  $\mathbf{a}_x = 18\mathbf{i}$  and  $\mathbf{a}_y = 26\mathbf{j}$  *Ans. (a)*

(b) At  $(x, y) = (1, 2)$ ,  $\mathbf{V} = -2\mathbf{i} - 6\mathbf{j}$ . A unit vector along a  $40^\circ$  line would be  $\mathbf{n} = \cos 40^\circ \mathbf{i} + \sin 40^\circ \mathbf{j}$ . Then the velocity component along a  $40^\circ$  line is

$$V_{40^\circ} = \mathbf{V} \cdot \mathbf{n}_{40^\circ} = (-2\mathbf{i} - 6\mathbf{j}) \cdot (\cos 40^\circ \mathbf{i} + \sin 40^\circ \mathbf{j}) \approx 5.39 \text{ units} \quad \text{Ans. (b)}$$

(c) The maximum acceleration is  $\mathbf{a}_{\max} = [18^2 + 26^2]^{1/2} = 31.6 \text{ units at } \angle 55.3^\circ$  *Ans. (c, d)*

---

**4.4** Suppose that the temperature field  $T = 4x^2 - 3y^3$ , in arbitrary units, is associated with the velocity field of Prob. 4.3. Compute the rate of change  $dT/dt$  at  $(x, y) = (2, 1)$ .

**Solution:** For steady, two-dimensional flow, the rate of change of temperature is

$$\frac{dT}{dt} = u \frac{\partial T}{\partial x} + v \frac{\partial T}{\partial y} = (x^2 - y^2 + x)(8x) + (-2xy - y)(-9y^2)$$

At  $(x, y) = (2, 1)$ ,  $dT/dt = (5)(16) - 5(-9) = 125 \text{ units}$  *Ans.*

---

**4.5** The velocity field near a stagnation point (see Example 1.10) may be written in the form

$$u = \frac{U_o x}{L} \quad v = \frac{-U_o y}{L} \quad U_o \text{ and } L \text{ are constants}$$

(a) Show that the acceleration vector is purely radial. (b) For the particular case  $L = 1.5$  m, if the acceleration at  $(x, y) = (1 \text{ m}, 1 \text{ m})$  is  $25 \text{ m/s}^2$ , what is the value of  $U_o$ ?

**Solution:** (a) For two-dimensional steady flow, the acceleration components are

$$\frac{du}{dt} = u \frac{\partial u}{\partial x} + v \frac{\partial u}{\partial y} = \left( U_o \frac{x}{L} \right) \left( \frac{U_o}{L} \right) + \left( -U_o \frac{y}{L} \right) (0) = \frac{U_o^2}{L^2} x$$

$$\frac{dv}{dt} = u \frac{\partial v}{\partial x} + v \frac{\partial v}{\partial y} = \left( U_o \frac{x}{L} \right) (0) + \left( -U_o \frac{y}{L} \right) \left( -\frac{U_o}{L} \right) = \frac{U_o^2}{L^2} y$$

Therefore the resultant  $\mathbf{a} = (U_o^2/L^2)(x\mathbf{i} + y\mathbf{j}) = (U_o^2/L^2)\mathbf{r}$  (purely radial) *Ans. (a)*

(b) For the given resultant acceleration of  $25 \text{ m/s}^2$  at  $(x, y) = (1 \text{ m}, 1 \text{ m})$ , we obtain

$$|a| = 25 \frac{\text{m}}{\text{s}^2} = \frac{U_o^2}{L^2} |r| = \frac{U_o^2}{(1.5 \text{ m})^2} \sqrt{2} \text{ m}, \quad \text{solve for } U_o = \mathbf{6.3} \frac{\mathbf{m}}{\mathbf{s}} \quad \text{Ans. (b)}$$

**4.6** Assume that flow in the converging nozzle of Fig. P4.2 has the form  $\mathbf{V} = V_o(1 + 2x/L)\mathbf{i}$ . Compute (a) the fluid acceleration at  $x = L$ ; and (b) the time required for a fluid particle to travel from  $x = 0$  to  $x = L$ .

**Solution:** From Prob. 4.2, the general acceleration was computed to be

$$\frac{du}{dt} = u \frac{\partial u}{\partial x} = \frac{2V_o^2}{L} \left( 1 + \frac{2x}{L} \right) = \frac{\mathbf{6V_o^2}}{\mathbf{L}} \quad \text{at } x = L \quad \text{Ans. (a)}$$

(b) The trajectory of a fluid particle is computed from the fact that  $u = dx/dt$ :

$$u = \frac{dx}{dt} = V_o \left( 1 + \frac{2x}{L} \right), \quad \text{or: } \int_0^L \frac{dx}{1 + 2x/L} = \int_0^{\Delta t} V_o dt,$$

$$\text{or: } \Delta t_{0-L} = \frac{\mathbf{L}}{\mathbf{2V_o}} \ln(\mathbf{3}) \quad \text{Ans. (b)}$$

**4.7** Consider a sphere of radius  $R$  immersed in a uniform stream  $U_o$ , as shown in Fig. P4.7. According to the theory of Chap. 8, the fluid velocity along streamline  $AB$  is given by

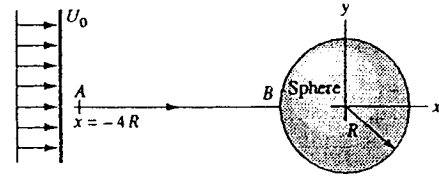


Fig. P4.7

$$\mathbf{V} = u\mathbf{i} = U_o \left( 1 + \frac{R^3}{x^3} \right) \mathbf{i}$$

Find (a) the position of maximum fluid acceleration along  $AB$  and (b) the time required for a fluid particle to travel from  $A$  to  $B$ .

**Solution:** (a) Along this streamline, the fluid acceleration is one-dimensional:

$$\frac{du}{dt} = u \frac{\partial u}{\partial x} = U_o (1 + R^3/x^3) (-3U_o R^3/x^4) = -3U_o R^3 (x^{-4} + R^3 x^{-7}) \quad \text{for } x \leq -R$$

The maximum occurs where  $d(a_x)/dx = 0$ , or at  $x = -(7R^3/4)^{1/3} \approx -1.205R$  Ans. (a)

(b) The time required to move along this path from  $A$  to  $B$  is computed from

$$u = \frac{dx}{dt} = U_o (1 + R^3/x^3), \quad \text{or:} \quad \int_{-4R}^{-R} \frac{dx}{1 + R^3/x^3} = \int_0^t U_o dt,$$

$$\text{or:} \quad U_o t = \left[ x - \frac{R}{6} \ln \frac{(x+R)^2}{x^2 - Rx + R^2} + \frac{R}{\sqrt{3}} \tan^{-1} \left( \frac{2x-R}{R\sqrt{3}} \right) \right]_{-4R}^{-R} = \infty$$

It takes **an infinite time** to actually *reach* the stagnation point, where the velocity is zero. Ans. (b)

**4.8** When a valve is opened, fluid flows in the expansion duct of Fig. P4.8 according to the approximation

$$\mathbf{V} = \mathbf{i}U \left( 1 - \frac{x}{2L} \right) \tanh \frac{Ut}{L}$$

Find (a) the fluid acceleration at  $(x, t) = (L, L/U)$  and (b) the time for which the fluid acceleration at  $x = L$  is zero. Why does the fluid acceleration become negative after condition (b)?

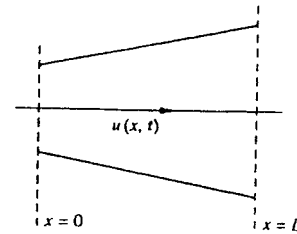


Fig. P4.8

**Solution:** This is a one-dimensional *unsteady* flow. The acceleration is

$$\begin{aligned} a_x &= \frac{\partial u}{\partial t} + u \frac{\partial u}{\partial x} = U \left(1 - \frac{x}{2L}\right) \frac{U}{L} \operatorname{sech}^2\left(\frac{Ut}{L}\right) - U \left(1 - \frac{x}{2L}\right) \left(\frac{U}{2L}\right) \tanh\left(\frac{Ut}{L}\right) \\ &= \frac{U^2}{L} \left(1 - \frac{x}{2L}\right) \left[ \operatorname{sech}^2\left(\frac{Ut}{L}\right) - \frac{1}{2} \tanh\left(\frac{Ut}{L}\right) \right] \end{aligned}$$

At  $(x, t) = (L, L/U)$ ,  $\mathbf{a}_x = (U^2/L)(1/2)[\operatorname{sech}^2(1) - 0.5 \tanh(1)] \approx \mathbf{0.0196U^2/L}$  *Ans.* (a)

The acceleration becomes zero when

$$\begin{aligned} \operatorname{sech}^2\left(\frac{Ut}{L}\right) &= \frac{1}{2} \tanh\left(\frac{Ut}{L}\right), \quad \text{or} \quad \frac{1}{2} \sinh\left(\frac{2Ut}{L}\right) = 2, \\ \text{or: } \frac{Ut}{L} &\approx \mathbf{1.048} \quad \text{Ans. (b)} \end{aligned}$$

The acceleration starts off positive, then goes through zero and turns negative as the negative *convective* acceleration overtakes the decaying positive *local* acceleration.

**4.9** An idealized incompressible flow has the proposed three-dimensional velocity distribution

$$\mathbf{V} = 4xy^2\mathbf{i} + f(y)\mathbf{j} - zy^2\mathbf{k}$$

Find the appropriate form of the function  $f(y)$  which satisfies the continuity relation.

**Solution:** Simply substitute the given velocity components into the incompressible continuity equation:

$$\begin{aligned} \frac{\partial u}{\partial x} + \frac{\partial v}{\partial y} + \frac{\partial w}{\partial z} &= \frac{\partial}{\partial x}(4xy^2) + \frac{\partial f}{\partial y} + \frac{\partial}{\partial z}(-zy^2) = 4y^2 + \frac{df}{dy} - y^2 = 0 \\ \text{or: } \frac{df}{dy} &= -3y^2. \quad \text{Integrate: } f(y) = \int (-3y^2)dy = -\mathbf{y^3} + \mathbf{constant} \quad \text{Ans.} \end{aligned}$$

**4.10** After discarding any constants of integration, determine the appropriate value of the unknown velocities  $u$  or  $v$  which satisfy the equation of two-dimensional incompressible continuity for:

$$\text{(a) } u = x^2y; \quad \text{(b) } v = x^2y; \quad \text{(c) } u = x^2 - xy; \quad \text{(d) } v = y^2 - xy$$

**Solution:** Substitute the given component into continuity and solve for the unknown component:

$$(a) \frac{\partial u}{\partial x} + \frac{\partial v}{\partial y} = 0 = \frac{\partial}{\partial x}(x^2y) + \frac{\partial v}{\partial y}; \frac{\partial v}{\partial y} = -2xy, \quad \text{or: } \mathbf{v} = -xy^2 + \mathbf{f(x)} \quad \text{Ans. (a)}$$

$$(b) \frac{\partial u}{\partial x} + \frac{\partial v}{\partial y} = 0 = \frac{\partial u}{\partial x} + \frac{\partial}{\partial y}(x^2y); \frac{\partial u}{\partial x} = -x^2, \quad \text{or: } \mathbf{u} = -\frac{x^3}{3} + \mathbf{f(y)} \quad \text{Ans. (b)}$$

$$(c) \frac{\partial u}{\partial x} + \frac{\partial v}{\partial y} = 0 = \frac{\partial}{\partial x}(x^2 - xy) + \frac{\partial v}{\partial y}; \frac{\partial v}{\partial y} = -2x + y, \quad \text{or: } \mathbf{v} = -2xy + \frac{y^2}{2} + \mathbf{f(x)} \quad \text{Ans. (c)}$$

$$(d) \frac{\partial u}{\partial x} + \frac{\partial v}{\partial y} = 0 = \frac{\partial u}{\partial x} + \frac{\partial}{\partial y}(y^2 - xy); \frac{\partial u}{\partial x} = -2y + x \quad \text{or: } \mathbf{u} = -2xy + \frac{x^2}{2} + \mathbf{f(y)} \quad \text{Ans. (d)}$$

**4.11** Derive Eq. (4.12b) for cylindrical coordinates by considering the flux of an incompressible fluid in and out of the elemental control volume in Fig. 4.2.

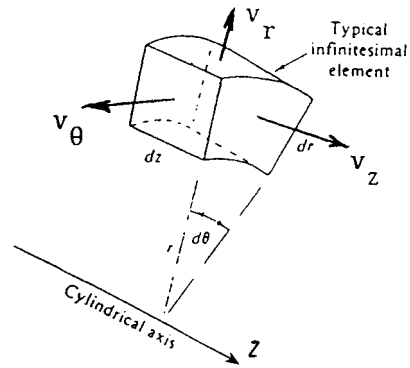


Fig. 4.2

**Solution:** For the differential CV shown,

$$\frac{\partial \rho}{\partial t} d\text{vol} + \sum \dot{m}_{\text{out}} - \sum \dot{m}_{\text{in}} = 0$$

$$\begin{aligned} & \frac{\partial \rho}{\partial t} \left( r + \frac{dr}{2} \right) d\theta dr dz + \rho v_r r dz d\theta + \frac{\partial}{\partial r} (\rho v_r) dr (r + dr) dz d\theta + \rho v_\theta dz dr \\ & + \frac{\partial}{\partial \theta} (\rho v_\theta) d\theta dz dr + \rho v_z \left( r + \frac{dr}{2} \right) d\theta dr + \frac{\partial}{\partial z} (\rho v_z) \left( r + \frac{dr}{2} \right) d\theta dr \\ & - \rho v_r r dz d\theta - \rho v_\theta dz dr - \rho v_z \left( r + \frac{dr}{2} \right) d\theta dr = 0 \end{aligned}$$

Cancel  $(d\theta dr dz)$  and higher-order (4th-order) differentials such as  $(dr d\theta dz dr)$  and, finally, divide by  $r$  to obtain the final result:

$$\frac{\partial \rho}{\partial t} + \frac{1}{r} \frac{\partial}{\partial r} (\rho r v_r) + \frac{1}{r} \frac{\partial}{\partial \theta} (\rho v_\theta) + \frac{\partial}{\partial z} (\rho v_z) = 0 \quad \text{Ans.}$$

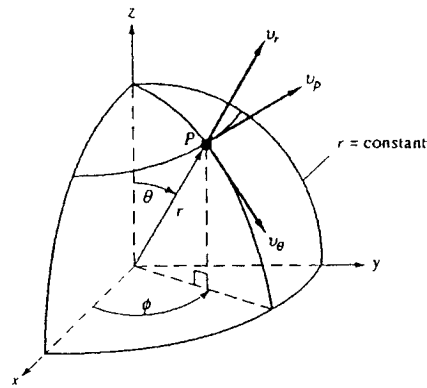
**4.12** Spherical polar coordinates  $(r, \theta, \phi)$  are defined in Fig. P4.12. The cartesian transformations are

$$x = r \sin \theta \cos \phi$$

$$y = r \sin \theta \sin \phi$$

$$z = r \cos \theta$$

Do not show that the cartesian incompressible continuity relation (4.12a) can be transformed to the spherical polar form



**Fig. P4.12**

$$\frac{1}{r^2} \frac{\partial}{\partial r} (r^2 v_r) + \frac{1}{r \sin \theta} \frac{\partial}{\partial \theta} (v_\theta \sin \theta) + \frac{1}{r \sin \theta} \frac{\partial}{\partial \phi} (v_\phi) = 0$$

What is the most general form of  $v_r$  when the flow is purely radial, that is,  $v_\theta$  and  $v_\phi$  are zero?

**Solution:** *Note to instructors: Do not assign the derivation part of this problem, it takes years to achieve, the writer can't do it successfully.* The problem is only meant to acquaint students with spherical coordinates. The second part is OK:

$$\text{If } v_\theta = v_\phi = 0, \text{ then } \frac{1}{r^2} \frac{\partial}{\partial r} (r^2 v_r) = 0, \text{ so, in general, } \mathbf{v}_r = \frac{1}{r^2} \mathbf{fcn}(\theta, \phi) \quad \text{Ans.}$$

**4.13** A two dimensional velocity field is given by

$$u = -\frac{Ky}{x^2 + y^2} \quad v = \frac{Kx}{x^2 + y^2}$$

where  $K$  is constant. Does this field satisfy incompressible continuity? Transform these velocities to polar components  $v_r$  and  $v_\theta$ . What might the flow represent?

**Solution:** Yes, continuity,  $\partial u / \partial x + \partial v / \partial y = 0$ , is satisfied. If you transform to polar coordinates,  $x = r \cos \theta$  and  $y = r \sin \theta$ , you obtain

$$\mathbf{v}_r = 0 \quad \mathbf{v}_\theta = \frac{\mathbf{K}}{\mathbf{r}} \quad \text{which represents a } \textit{potential vortex} \text{ (see Section 4.10 of text).} \quad \text{Ans.}$$



**4.14** For incompressible polar-coordinate flow, what is the most general form of a purely circulatory motion,  $v_\theta = v_\theta(r, \theta, t)$  and  $v_r = 0$ , which satisfies continuity?

**Solution:** If  $v_r = 0$ , the plane polar coordinate continuity equation reduces to:

$$\frac{1}{r} \frac{\partial v_\theta}{\partial \theta} = 0, \quad \text{or: } v_\theta = \mathbf{fcn}(\mathbf{r}) \quad \text{Ans.}$$

**4.15** What is the most general form of a purely radial polar-coordinate incompressible-flow pattern,  $v_r = v_r(r, \theta, t)$  and  $v_\theta = 0$ , which satisfies continuity?

**Solution:** If  $v_\theta = 0$ , the plane polar coordinate continuity equation reduces to:

$$\frac{1}{r} \frac{\partial}{\partial r}(rv_r) = 0, \quad \text{or: } v_r = \frac{1}{r} \mathbf{fcn}(\theta) \quad \text{Ans.}$$

**4.16** After discarding any constants of integration, determine the appropriate value of the unknown velocities  $w$  or  $v$  which satisfy the equation of three-dimensional incompressible continuity for:

$$(a) \quad u = x^2 yz, \quad v = -y^2 x; \quad (b) \quad u = x^2 + 3z^2 x, \quad w = -z^3 + y^2$$

**Solution:** Substitute into incompressible continuity and solve for the unknown component:

$$(a) \quad \frac{\partial u}{\partial x} + \frac{\partial v}{\partial y} + \frac{\partial w}{\partial z} = 0 = \frac{\partial}{\partial x}(x^2 yz) + \frac{\partial}{\partial y}(-y^2 x) + \frac{\partial w}{\partial z}; \quad \frac{\partial w}{\partial z} = -2xyz + 2yx,$$

$$\text{or: } w = -xyz^2 + 2xyz \quad \text{Ans. (a)}$$

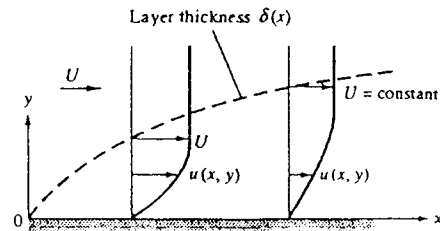
$$(b) \quad \frac{\partial u}{\partial x} + \frac{\partial v}{\partial y} + \frac{\partial w}{\partial z} = 0 = \frac{\partial}{\partial x}(x^2 + 3z^2 x) + \frac{\partial v}{\partial y} + \frac{\partial}{\partial z}(-z^3 + y^2); \quad \frac{\partial v}{\partial y} = -2x - 3z^2 + 3z^2$$

$$\text{or: } v = -2xy \quad \text{Ans. (b)}$$

**4.17** A reasonable approximation for the two-dimensional incompressible laminar boundary layer on the flat surface in Fig. P4.17 is

$$u = U \left( \frac{2y}{\delta} - \frac{y^2}{\delta^2} \right) \quad \text{for } y \leq \delta$$

$$\text{where } \delta \approx Cx^{1/2}, \quad C = \text{const}$$



**Fig. P4.17**

(a) Assuming a no-slip condition at the wall, find an expression for the velocity component  $v(x, y)$  for  $y \leq \delta$ . (b) Then find the maximum value of  $v$  at the station  $x = 1$  m, for the particular case of airflow, when  $U = 3$  m/s and  $\delta = 1.1$  cm.

**Solution:** The two-dimensional incompressible continuity equation yields

$$\frac{\partial v}{\partial y} = -\frac{\partial u}{\partial x} = -U \left( \frac{-2y}{\delta^2} \frac{d\delta}{dx} + \frac{2y^2}{\delta^3} \frac{d\delta}{dx} \right), \quad \text{or:} \quad v = 2U \frac{d\delta}{dx} \int_0^y \left( \frac{y}{\delta^2} - \frac{y^2}{\delta^3} \right) dy \Big|_{x=\text{const}}$$

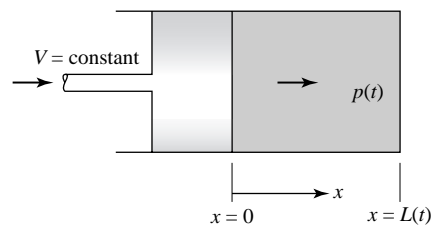
$$\text{or:} \quad v = 2U \frac{d\delta}{dx} \left( \frac{y^2}{2\delta^2} - \frac{y^3}{3\delta^3} \right), \quad \text{where} \quad \frac{d\delta}{dx} = \frac{C}{2\sqrt{x}} = \frac{\delta}{2x} \quad \text{Ans. (a)}$$

(b) We see that  $v$  increases monotonically with  $y$ , thus  $v_{\max}$  occurs at  $y = \delta$ :

$$v_{\max} = v|_{y=\delta} = \frac{U\delta}{6x} = \frac{(3 \text{ m/s})(0.011 \text{ m})}{6(1 \text{ m})} = \mathbf{0.0055} \frac{\mathbf{m}}{\mathbf{s}} \quad \text{Ans. (b)}$$

This estimate is within 4% of the exact  $v_{\max}$  computed from boundary layer theory.

**4.18** A piston compresses gas in a cylinder by moving at constant speed  $V$ , as in Fig. P4.18. Let the gas density and length at  $t = 0$  be  $\rho_0$  and  $L_0$ , respectively. Let the gas velocity vary linearly from  $u = V$  at the piston face to  $u = 0$  at  $x = L$ . If the gas density varies only with time, find an expression for  $\rho(t)$ .



**Fig. P4.18**

**Solution:** The one-dimensional unsteady continuity equation reduces to

$$\frac{\partial \rho}{\partial t} + \frac{\partial}{\partial x}(\rho u) = \frac{d\rho}{dt} + \rho \frac{\partial u}{\partial x}, \quad \text{where} \quad u = V \left( 1 - \frac{x}{L} \right), \quad L = L_0 - Vt, \quad \rho = \rho(t) \text{ only}$$

$$\text{Enter} \quad \frac{\partial u}{\partial x} = -\frac{V}{L} \quad \text{and separate variables:} \quad \int_{\rho_0}^{\rho} \frac{d\rho}{\rho} = V \int_0^t \frac{dt}{L_0 - Vt}$$

$$\text{The solution is} \quad \ln(\rho/\rho_0) = -\ln(1 - Vt/L_0), \quad \text{or:} \quad \rho = \rho_0 \left( \frac{L_0}{L_0 - Vt} \right) \quad \text{Ans.}$$

**4.19** An incompressible flow field has the cylinder components  $v_\theta = Cr$ ,  $v_z = K(R^2 - r^2)$ ,  $v_r = 0$ , where  $C$  and  $K$  are constants and  $r \leq R$ ,  $z \leq L$ . Does this flow satisfy continuity? What might it represent physically?

**Solution:** We check the incompressible continuity relation in cylindrical coordinates:

$$\frac{1}{r} \frac{\partial}{\partial r}(rv_r) + \frac{1}{r} \frac{\partial v_\theta}{\partial \theta} + \frac{\partial v_z}{\partial z} = 0 = 0 + 0 + 0 \quad \text{satisfied identically} \quad \text{Ans.}$$

This flow also satisfies (cylindrical) momentum and could represent laminar flow inside a tube of radius  $R$  whose outer wall ( $r = R$ ) is rotating at uniform angular velocity.

**4.20** A two-dimensional incompressible velocity field has  $u = K(1 - e^{-ay})$ , for  $x \leq L$  and  $0 \leq y \leq \infty$ . What is the most general form of  $v(x, y)$  for which continuity is satisfied and  $v = v_0$  at  $y = 0$ ? What are the proper dimensions for constants  $K$  and  $a$ ?

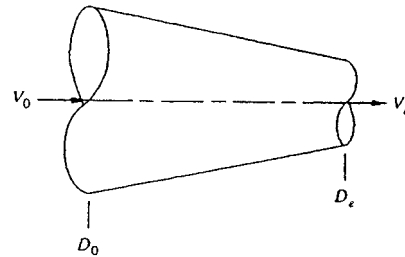
**Solution:** We can find the appropriate velocity  $v$  from two-dimensional continuity:

$$\frac{\partial v}{\partial y} = -\frac{\partial u}{\partial x} = -\frac{\partial}{\partial x}[K(1 - e^{-ay})] = 0, \quad \text{or: } v = \text{fcn}(x) \text{ only}$$

Since  $v = v_0$  at  $y = 0$  for all  $x$ , then it must be that  $v = v_0 = \text{const}$  Ans.

The dimensions of  $K$  are  $\{K\} = \{L/T\}$  and the dimensions of  $a$  are  $\{L^{-1}\}$ . Ans.

**4.21** Air flows under steady, approximately one-dimensional conditions through the conical nozzle in Fig. P4.21. If the speed of sound is approximately 340 m/s, what is the minimum nozzle-diameter ratio  $D_e/D_o$  for which we can safely neglect compressibility effects if  $V_o =$  (a) 10 m/s and (b) 30 m/s?



**Fig. P4.21**

**Solution:** If we apply one-dimensional continuity to this duct,

$$\rho_o V_o \frac{\pi}{4} D_o^2 = \rho_e V_e \frac{\pi}{4} D_e^2, \quad \text{or} \quad V_o \approx V_e (D_e/D_o)^2 \quad \text{if } \rho_o \approx \rho_e$$

To avoid compressibility corrections, we require (Eq. 4.18) that  $Ma \leq 0.3$  or, in this case, the highest velocity (at the exit) should be  $V_e \leq 0.3(340) = 102$  m/s. Then we compute

$$\begin{aligned} (D_e/D_o)_{\min} &= (V_o/V_e)^{1/2} = (V_o/102)^{1/2} = \mathbf{0.31} \quad \text{if } V_o = 10 \text{ m/s} \quad \text{Ans. (a)} \\ &= \mathbf{0.54} \quad \text{if } V_o = 30 \text{ m/s} \quad \text{Ans. (b)} \end{aligned}$$

**4.22** A flow field in the  $x$ - $y$  plane is described by  $u = U_o = \text{constant}$ ,  $v = V_o = \text{constant}$ . Convert these velocities into plane polar coordinate velocities,  $v_r$  and  $v_\theta$ .

**Solution:** Each pair of components must add to give the total velocity, as seen in the sketch at right.

The geometry of the figure shows that

$$v_r = U_o \cos \theta + V_o \sin \theta;$$

$$v_\theta = -U_o \sin \theta + V_o \cos \theta \quad \text{Ans.}$$

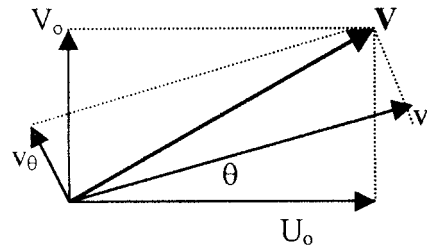


Fig. P4.22

**4.23** A tank volume  $V$  contains gas at conditions  $(\rho_o, p_o, T_o)$ . At time  $t = 0$  it is punctured by a small hole of area  $A$ . According to the theory of Chap. 9, the mass flow out of such a hole is approximately proportional to  $A$  and to the tank pressure. If the tank temperature is assumed constant and the gas is ideal, find an expression for the variation of density within the tank.

**Solution:** This problem is a realistic approximation of the “blowdown” of a high-pressure tank, where the exit mass flow is choked and thus proportional to tank pressure. For a control volume enclosing the tank and cutting through the exit jet, the mass relation is

$$\frac{d}{dt}(m_{\text{tank}}) + \dot{m}_{\text{exit}} = 0, \quad \text{or:} \quad \frac{d}{dt}(\rho v) = -\dot{m}_{\text{exit}} = -CpA, \quad \text{where } C = \text{constant}$$

$$\text{Introduce } \rho = \frac{p}{RT_o} \quad \text{and separate variables:} \quad \int_{p_o}^{p(t)} \frac{dp}{p} = -\frac{CRT_o A}{v} \int_0^t dt$$

The solution is an exponential decay of tank density:  $p = p_o \exp(-CRT_o At/v)$ . *Ans.*

**4.24** Reconsider Fig. P4.17 in the following general way. It is known that the boundary layer thickness  $\delta(x)$  increases monotonically and that there is no slip at the wall ( $y = 0$ ). Further,  $u(x, y)$  merges smoothly with the outer stream flow, where  $u \approx U = \text{constant}$  outside the layer. Use these facts to prove that (a) the component  $v(x, y)$  is positive everywhere within the layer, (b)  $v$  increases parabolically with  $y$  very near the wall, and (c)  $v$  is a maximum at  $y = \delta$ .

**Solution:** (a) First, if  $\delta$  is continually increasing with  $x$ , then  $u$  is continually *decreasing* with  $x$  in the boundary layer, that is,  $\partial u / \partial x < 0$ , hence  $\partial v / \partial y = -\partial u / \partial x > 0$  everywhere. It follows that, if  $\partial v / \partial y > 0$  and  $v = 0$  at  $y = 0$ , then  $v(x, y) > 0$  for all  $y \leq \delta$ . *Ans.* (a)

(b) At the wall,  $u$  must be approximately linear with  $y$ , if  $\tau_w \geq 0$ :

Near wall:  $u \approx y f(x)$ , or  $\frac{\partial u}{\partial x} = y \frac{df}{dx}$ , where  $\frac{df}{dx} < 0$ . Then  $\frac{\partial v}{\partial y} = -\frac{\partial u}{\partial x} = \left(\frac{df}{dx}\right) y$

Thus, near the wall,  $v \approx \left(\frac{df}{dx}\right) \int_0^y y dy \approx \left(\frac{df}{dx}\right) \frac{y^2}{2}$  **Parabolic** Ans. (b)

(c) At  $y = \delta$ ,  $u \rightarrow U$ , then  $\partial u / \partial x \approx 0$  there and thus  $\partial v / \partial y \approx 0$ , or  $v = v_{\max}$ . Ans. (c)

**4.25** An incompressible flow in polar coordinates is given by

$$v_r = K \cos \theta \left(1 - \frac{b}{r^2}\right)$$

$$v_\theta = -K \sin \theta \left(1 + \frac{b}{r^2}\right)$$

Does this field satisfy continuity? For consistency, what should the dimensions of constants  $K$  and  $b$  be? Sketch the surface where  $v_r = 0$  and interpret.

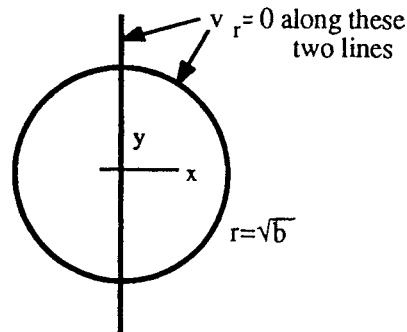


Fig. P4.25

**Solution:** Substitute into plane polar coordinate continuity:

$$\frac{1}{r} \frac{\partial}{\partial r} (r v_r) + \frac{1}{r} \frac{\partial v_\theta}{\partial \theta} = 0 \stackrel{?}{=} \frac{1}{r} \frac{\partial}{\partial r} \left[ K \cos \theta \left( r - \frac{b}{r} \right) \right] + \frac{1}{r} \frac{\partial}{\partial \theta} \left[ -K \sin \theta \left( 1 + \frac{b}{r^2} \right) \right] = 0 \text{ Satisfied}$$

The dimensions of  $K$  must be velocity,  $\{K\} = \{L/T\}$ , and  $b$  must be area,  $\{b\} = \{L^2\}$ . The surfaces where  $v_r = 0$  are the  $y$ -axis and the circle  $r = \sqrt{b}$ , as shown above. The pattern represents inviscid flow of a uniform stream past a circular cylinder (Chap. 8).

**4.26** Curvilinear, or streamline, coordinates are defined in Fig. P4.26, where  $n$  is normal to the streamline in the plane of the radius of curvature  $R$ . Show that Euler's frictionless momentum equation (4.36) in streamline coordinates becomes

$$\frac{\partial V}{\partial t} + V \frac{\partial V}{\partial s} = -\frac{1}{\rho} \frac{\partial p}{\partial s} + g_s \quad (1)$$

$$-V \frac{\partial \theta}{\partial t} - \frac{V^2}{R} = -\frac{1}{\rho} \frac{\partial p}{\partial n} + g_n \quad (2)$$

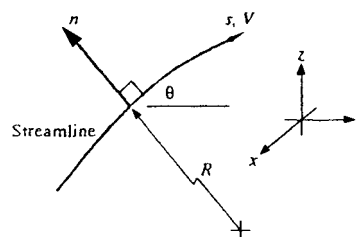


Fig. P4.26

Further show that the integral of Eq. (1) with respect to  $s$  is none other than our old friend Bernoulli's equation (3.76).

**Solution:** This a laborious derivation, really, **the problem is only meant to acquaint the student with streamline coordinates.** The second part is not too hard, though. Multiply the streamwise momentum equation by  $ds$  and integrate:

$$\frac{\partial V}{\partial t} ds + V dV = -\frac{dp}{\rho_2} + g_s ds = -\frac{dp}{\rho} - g \sin \theta ds = -\frac{dp}{\rho} - g dz$$

Integrate from 1 to 2:  $\int_1^2 \frac{\partial V}{\partial t} ds + \frac{V_2^2 - V_1^2}{2} + \int_1^2 \frac{dp}{\rho} + g(z_2 - z_1) = 0$  (Bernoulli) *Ans.*

**4.27** A frictionless, incompressible steady-flow field is given by

$$\mathbf{V} = 2xy\mathbf{i} - y^2\mathbf{j}$$

in arbitrary units. Let the density be  $\rho_0 = \text{constant}$  and neglect gravity. Find an expression for the pressure gradient in the  $x$  direction.

**Solution:** For this (gravity-free) velocity, the momentum equation is

$$\rho \left( u \frac{\partial \mathbf{V}}{\partial x} + v \frac{\partial \mathbf{V}}{\partial y} \right) = -\nabla p, \quad \text{or: } \rho_0 [(2xy)(2y\mathbf{i}) + (-y^2)(2x\mathbf{i} - 2y\mathbf{j})] = -\nabla p$$

Solve for  $\nabla p = -\rho_0(2xy^2\mathbf{i} + 2y^3\mathbf{j})$ , or:  $\frac{\partial p}{\partial x} = -\rho_0 2xy^2$  *Ans.*

**4.28** If  $z$  is "up," what are the conditions on constants  $a$  and  $b$  for which the velocity field  $u = ay$ ,  $v = bx$ ,  $w = 0$  is an exact solution to the continuity and Navier-Stokes equations for incompressible flow?

**Solution:** First examine the continuity equation:

$$\frac{\partial u}{\partial x} + \frac{\partial v}{\partial y} + \frac{\partial w}{\partial z} \stackrel{?}{=} 0 = \frac{\partial}{\partial x}(ay) + \frac{\partial}{\partial y}(bx) + \frac{\partial}{\partial z}(0) = 0 + 0 + 0 \quad \text{for all } a \text{ and } b$$

Given  $g_x = g_y = 0$  and  $w = 0$ , we need only examine  $x$ - and  $y$ -momentum:

$$\rho \left( u \frac{\partial u}{\partial x} + v \frac{\partial u}{\partial y} \right) = -\frac{\partial p}{\partial x} + \mu \left( \frac{\partial^2 u}{\partial x^2} + \frac{\partial^2 u}{\partial y^2} \right) = \rho [(ay)(0) + (bx)(a)] = -\frac{\partial p}{\partial x} + \mu(0+0)$$

$$\rho \left( u \frac{\partial v}{\partial x} + v \frac{\partial v}{\partial y} \right) = -\frac{\partial p}{\partial y} + \mu \left( \frac{\partial^2 v}{\partial x^2} + \frac{\partial^2 v}{\partial y^2} \right) = \rho [(ay)(b) + (bx)(0)] = -\frac{\partial p}{\partial y} + \mu(0+0)$$

Solve for  $\frac{\partial p}{\partial x} = -\rho abx$  and  $\frac{\partial p}{\partial y} = -\rho aby$ , or:  $\mathbf{p} = -\frac{\rho}{2} \mathbf{ab}(x^2 + y^2) + \text{const}$  Ans.

The given velocity field,  $u = ay$  and  $v = bx$ , is an exact solution independent of a or b. It is not, however, an “irrotational” flow.

**4.29** Consider a steady, two-dimensional, incompressible flow of a newtonian fluid with the velocity field  $u = -2xy$ ,  $v = y^2 - x^2$ , and  $w = 0$ . (a) Does this flow satisfy conservation of mass? (b) Find the pressure field  $p(x, y)$  if the pressure at point  $(x = 0, y = 0)$  is equal to  $p_a$ .

**Solution:** Evaluate and check the incompressible continuity equation:

$$\frac{\partial u}{\partial x} + \frac{\partial v}{\partial y} + \frac{\partial w}{\partial z} = 0 = -2y + 2y + 0 \equiv 0 \quad \text{Yes!} \quad \text{Ans. (a)}$$

(b) Find the pressure gradients from the Navier-Stokes  $x$ - and  $y$ -relations:

$$\rho \left( u \frac{\partial u}{\partial x} + v \frac{\partial u}{\partial y} + w \frac{\partial u}{\partial z} \right) = -\frac{\partial p}{\partial x} + \mu \left( \frac{\partial^2 u}{\partial x^2} + \frac{\partial^2 u}{\partial y^2} + \frac{\partial^2 u}{\partial z^2} \right), \quad \text{or:}$$

$$\rho[-2xy(-2y) + (y^2 - x^2)(-2x)] = -\frac{\partial p}{\partial x} + \mu(0 + 0 + 0), \quad \text{or:} \quad \frac{\partial p}{\partial x} = -2\rho(xy^2 + x^3)$$

and, similarly for the  $y$ -momentum relation,

$$\rho \left( u \frac{\partial v}{\partial x} + v \frac{\partial v}{\partial y} + w \frac{\partial v}{\partial z} \right) = -\frac{\partial p}{\partial y} + \mu \left( \frac{\partial^2 v}{\partial x^2} + \frac{\partial^2 v}{\partial y^2} + \frac{\partial^2 v}{\partial z^2} \right), \quad \text{or:}$$

$$\rho[-2xy(-2x) + (y^2 - x^2)(2y)] = -\frac{\partial p}{\partial y} + \mu(-2 + 2 + 0), \quad \text{or:} \quad \frac{\partial p}{\partial y} = -2\rho(x^2y + y^3)$$

The two gradients  $\partial p/\partial x$  and  $\partial p/\partial y$  may be integrated to find  $p(x, y)$ :

$$p = \int \frac{\partial p}{\partial x} dx|_{y=\text{const}} = -2\rho \left( \frac{x^2y^2}{2} + \frac{x^4}{4} \right) + f(y), \quad \text{then differentiate.}$$

$$\frac{\partial p}{\partial y} = -2\rho(x^2y) + \frac{df}{dy} = -2\rho(x^2y + y^3), \quad \text{whence} \quad \frac{df}{dy} = -2\rho y^3, \quad \text{or:} \quad f(y) = -\frac{\rho}{2}y^4 + C$$

$$\text{Thus:} \quad p = -\frac{\rho}{2}(2x^2y^2 + x^4 + y^4) + C = p_a \quad \text{at} \quad (x, y) = (0, 0), \quad \text{or:} \quad \mathbf{C} = \mathbf{p}_a$$

Finally, the pressure field for this flow is given by

$$\mathbf{p} = \mathbf{p}_a - \frac{1}{2}\rho(2x^2y^2 + x^4 + y^4) \quad \text{Ans. (b)}$$

**4.30** Show that the two-dimensional flow field of Example 1.10 is an exact solution to the incompressible Navier-Stokes equation. Neglecting gravity, compute the pressure field  $p(x, y)$  and relate it to the absolute velocity  $V^2 = u^2 + v^2$ . Interpret the result.

**Solution:** In Example 1.10, the velocities were  $u = Kx$ ,  $v = -Ky$ ,  $w = 0$ ,  $K = \text{constant}$ . This flow satisfies continuity identically. Let us try it in the two momentum equations:

$$\rho \left( u \frac{\partial u}{\partial x} + v \frac{\partial u}{\partial y} \right) = \rho[(Kx)K + 0] = -\frac{\partial p}{\partial x} + \mu \nabla^2 u = -\frac{\partial p}{\partial x} + 0, \quad \text{or: } \frac{\partial p}{\partial x} = -\rho K^2 x$$

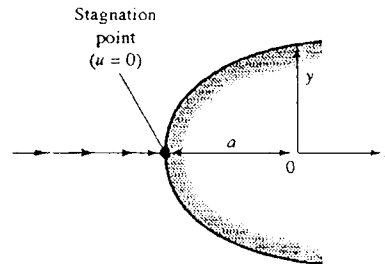
$$\rho \left( u \frac{\partial v}{\partial x} + v \frac{\partial v}{\partial y} \right) = \rho[0 + (-Ky)(-K)] = -\frac{\partial p}{\partial y} + \mu \nabla^2 v = -\frac{\partial p}{\partial y} + 0, \quad \text{or: } \frac{\partial p}{\partial y} = -\rho K^2 y$$

Integrate the two pressure gradients to obtain

$$p = -\frac{\rho}{2}[(Kx)^2 + (Ky)^2] + \text{const}, \quad \text{or: } p + \frac{1}{2}\rho(u^2 + v^2) = \text{const} \quad \text{Ans.}$$

The given velocity is an exact solution and the pressure satisfies Bernoulli's equation.

**4.31** According to potential theory (Chap. 8) for the flow approaching a rounded two-dimensional body, as in Fig. P4.31, the velocity approaching the stagnation point is given by  $u = U(1 - a^2/x^2)$ , where  $a$  is the nose radius and  $U$  is the velocity far upstream. Compute the value and position of the maximum viscous normal stress along this streamline. Is this also the position of maximum fluid deceleration? Evaluate the maximum viscous normal stress if the fluid is SAE 30 oil at 20°C, with  $U = 2$  m/s and  $a = 6$  cm.



**Fig. P4.31**

**Solution:** (a) Along this line of symmetry the convective deceleration is one-dimensional:

$$a_x = u \frac{\partial u}{\partial x} = U \left( 1 - \frac{a^2}{x^2} \right) U \left( \frac{2a^2}{x^3} \right) = 2U^2 \left( \frac{a^2}{x^3} - \frac{a^4}{x^5} \right)$$

This has a maximum deceleration at  $\frac{da_x}{dx} = 0$ , or at  $x = -\sqrt{(5/3)}a = -1.29a$  Ans. (a)

The value of maximum deceleration at this point is  $a_{x,\max} = -0.372U^2/a$ .



(b) The viscous normal stress along this line is given by

$$\tau_{xx} = 2\mu \frac{\partial u}{\partial x} = 2\mu \left( \frac{2a^2 U}{x^3} \right) \text{ with a maximum } \tau_{\max} = \frac{4\mu U}{a} \text{ at } x = -a \quad \text{Ans. (b)}$$

Thus maximum stress does not occur at the same position as maximum deceleration. For SAE 30 oil at 20°C, we obtain the numerical result

$$\text{SAE 30 oil, } \rho = 917 \frac{\text{kg}}{\text{m}^3}, \quad \mu = 0.29 \frac{\text{kg}}{\text{m}\cdot\text{s}}, \quad \tau_{\max} = \frac{4(0.29)(2.0)}{(0.06 \text{ m})} \approx \mathbf{39 \text{ Pa}} \quad \text{Ans. (b)}$$

**4.32** The answer to Prob. 4.14 is  $v_\theta = f(r)$  only. Do not reveal this to your friends if they are still working on Prob. 4.14. Show that this flow field is an exact solution to the Navier-Stokes equations (4.38) for only two special cases of the function  $f(r)$ . Neglect gravity. Interpret these two cases physically.

**Solution:** Given  $v_\theta = f(r)$  and  $v_r = v_z = 0$ , we need only satisfy the  $\theta$ -momentum relation:

$$\rho \left( v_r \frac{\partial v_\theta}{\partial r} + \frac{v_\theta}{r} \frac{\partial v_\theta}{\partial \theta} \right) = -\frac{1}{r} \frac{\partial p}{\partial \theta} + \mu \left[ \frac{1}{r} \frac{\partial}{\partial r} \left( r \frac{\partial v_\theta}{\partial r} \right) + \frac{1}{r^2} \frac{\partial^2 v_\theta}{\partial \theta^2} - \frac{v_\theta}{r^2} \right],$$

$$\text{or: } \rho(0+0) = -0 + \mu \left[ \frac{1}{r} \frac{d}{dr} \left( r \frac{df}{dr} \right) + 0 - \frac{f}{r^2} \right], \quad \text{or: } \mathbf{f'' + \frac{1}{r} f' - \frac{1}{r^2} f = 0}$$

This is the ‘equidimensional’ ODE and always has a solution in the form of a *power-law*,  $f = Cr^n$ . The two relevant solutions for these particular coefficients are:

$$\mathbf{f_1 = C_1 r} \text{ (solid-body rotation); } \quad \mathbf{f_2 = C_2/r} \text{ (irrotational vortex)} \quad \text{Ans.}$$

**4.33** From Prob. 4.15 the purely radial polar-coordinate flow which satisfies continuity is  $v_r = f(\theta)/r$ , where  $f$  is an arbitrary function. Determine what particular forms of  $f(\theta)$  satisfy the full Navier-Stokes equations in polar-coordinate form from Eqs. (D.5) and (D.6).

**Solution:** To resolve this solution, we must substitute into both the  $r$ - and  $\theta$ -momentum relations from Appendix D. The results, assuming  $v_r = f(\theta)/r$ , are:

$$\text{r-mom: } \frac{\partial p}{\partial r} = \frac{\rho}{r^3} f^2 + \frac{\mu}{r^3} f''; \quad \theta\text{-momentum: } \frac{\partial p}{\partial \theta} = \frac{2\mu}{r^2} f'$$

Cross-differentiate to eliminate  $\partial^2 p / \partial x \partial y$  and obtain the ODE  $\mu f''' + 2\rho f f' + 4\mu f' = 0$

This ODE has two types of solution, one very simple and one very complicated:

(1)  $f = \text{constant}$ , or:  $\mathbf{v}_r = \frac{\text{const}}{\mathbf{r}}$  (a line source, as in Chap. 4) *Ans.*

(2) **Elliptic-integral solution** to the complete ODE above: these solutions, which vary in many ways with  $\theta$ , represent “Jeffrey-Hamel” flow between plates. *Ans.*

For further discussion of “Jeffrey-Hamel” flow, see pp. 168–172 of Ref. 5, Chap. 4.

**4.34** A proposed three-dimensional incompressible flow field has the following vector form:

$$\mathbf{V} = Kx\mathbf{i} + Ky\mathbf{j} - 2Kz\mathbf{k}$$

(a) Determine if this field is a valid solution to continuity and Navier-Stokes. (b) If  $\mathbf{g} = -g\mathbf{k}$ , find the pressure field  $p(x, y, z)$ . (c) Is the flow irrotational?

**Solution:** (a) Substitute this field into the three-dimensional incompressible continuity equation:

$$\begin{aligned} \frac{\partial u}{\partial x} + \frac{\partial v}{\partial y} + \frac{\partial w}{\partial z} &= \frac{\partial}{\partial x}(Kx) + \frac{\partial}{\partial y}(Ky) + \frac{\partial}{\partial z}(-2Kz) \\ &= K + K - 2K = 0 \quad \text{Yes, satisfied.} \quad \text{Ans. (a)} \end{aligned}$$

(b) Substitute into the full incompressible Navier-Stokes equation (4.38). The laborious results are:

$$\text{x - momentum: } \rho(K^2x + 0 + 0) = -\frac{\partial p}{\partial x} + \mu(0 + 0 + 0)$$

$$\text{y - momentum: } \rho(0 + K^2y + 0) = -\frac{\partial p}{\partial y} + \mu(0 + 0 + 0)$$

$$\text{z - momentum: } \rho\{0 + 0 + (-2Kz)(-2K)\} = -\frac{\partial p}{\partial z} + \rho(-g) + \mu(0 + 0 + 0)$$

Integrate each equation for the pressure and collect terms. The result is

$$p = p(\mathbf{0}, \mathbf{0}, \mathbf{0}) - \rho gz - (\rho/2)K^2(x^2 + y^2 + 4z^2) \quad \text{Ans. (b)}$$

Note that the last term is identical to  $(\rho/2)(u^2 + v^2 + w^2)$ , in other words, Bernoulli's equation.

(c) For irrotational flow, the curl of the velocity field must be zero:

$$\nabla \times \mathbf{V} = \mathbf{i}(0 - 0) + \mathbf{j}(0 - 0) + \mathbf{k}(0 - 0) = \mathbf{0} \quad \text{Yes, irrotational.} \quad \text{Ans. (c)}$$

**4.35** From the Navier-Stokes equations for incompressible flow in polar coordinates (App. E for cylindrical coordinates), find the most general case of purely circulating motion  $v_\theta(r)$ ,  $v_r = v_z = 0$ , for flow with no slip between two fixed concentric cylinders, as in Fig. P4.35.

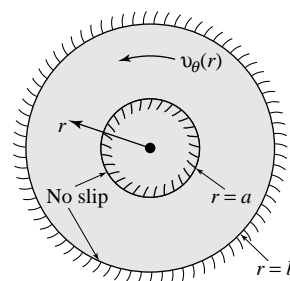


Fig. P4.35

**Solution:** The preliminary work for this problem is identical to Prob. 4.32 on the previous page. That is, there are two possible solutions for purely circulating motion  $v_\theta(r)$ , hence

$$v_\theta = C_1 r + \frac{C_2}{r}, \quad \text{subject to } v_\theta(a) = 0 = C_1 a + C_2/a \quad \text{and} \quad v_\theta(b) = 0 = C_1 b + C_2/b$$

This requires  $C_1 = C_2 = 0$ , or  $\mathbf{v}_\theta = \mathbf{0}$  (no steady motion possible between fixed walls) *Ans.*

**4.36** A constant-thickness film of viscous liquid flows in laminar motion down a plate inclined at angle  $\theta$ , as in Fig. P4.36. The velocity profile is

$$u = Cy(2h - y) \quad v = w = 0$$

Find the constant  $C$  in terms of the specific weight and viscosity and the angle  $\theta$ . Find the volume flux  $Q$  per unit width in terms of these parameters.

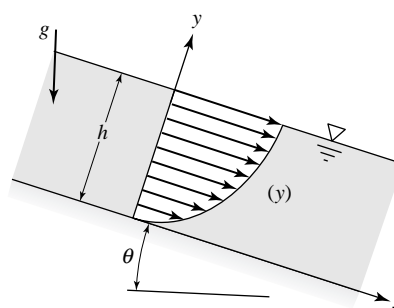


Fig. P4.36

**Solution:** There is atmospheric pressure all along the surface at  $y = h$ , hence  $\partial p / \partial x = 0$ . The x-momentum equation can easily be evaluated from the known velocity profile:

$$\rho \left( u \frac{\partial u}{\partial x} + v \frac{\partial u}{\partial y} \right) = -\frac{\partial p}{\partial x} + \rho g_x + \mu \nabla^2 u, \quad \text{or: } 0 = 0 + \rho g \sin \theta + \mu(-2C)$$

$$\text{Solve for } C = \frac{\rho g \sin \theta}{2\mu} \quad \text{Ans. (a)}$$

The flow rate per unit width is found by integrating the velocity profile and using  $C$ :

$$Q = \int_0^h u \, dy = \int_0^h Cy(2h - y) \, dy = \frac{2}{3} Ch^3 = \frac{\rho g h^3 \sin \theta}{3\mu} \quad \text{per unit width} \quad \text{Ans. (b)}$$

**4.37** A viscous liquid of constant density and viscosity falls due to gravity between two parallel plates a distance  $2h$  apart, as in the figure. The flow is fully developed, that is,  $w = w(x)$  only. There are no pressure gradients, only gravity. Set up and solve the Navier-Stokes equation for the velocity profile  $w(x)$ .

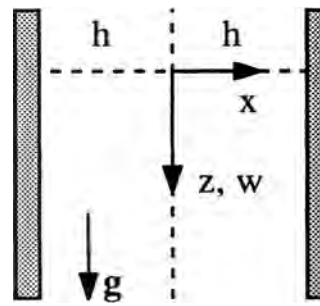


Fig. P4.37

**Solution:** Only the  $z$ -component of Navier-Stokes is relevant:

$$\rho \frac{dw}{dt} = 0 = \rho g + \mu \frac{d^2 w}{dx^2}, \quad \text{or: } w'' = -\frac{\rho g}{\mu}, \quad w(-h) = w(+h) = 0 \quad (\text{no-slip})$$

The solution is very similar to Eqs. (4.142) to (4.143) of the text:

$$w = \frac{\rho g}{2\mu} (h^2 - x^2) \quad \text{Ans.}$$

**4.38** Reconsider the angular-momentum balance of Fig. 4.5 by adding a concentrated *body couple*  $C_z$  about the  $z$  axis [6]. Determine a relation between the body couple and shear stress for equilibrium. What are the proper dimensions for  $C_z$ ? (Body couples are important in continuous media with microstructure, such as granular materials.)

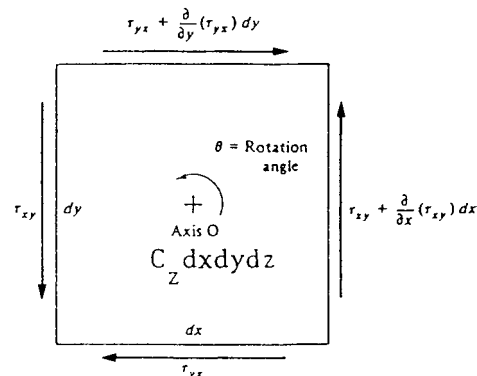


Fig. 4.5

**Solution:** The couple  $C_z$  has to be per unit volume to make physical sense in Eq. (4.39):

$$\left[ \tau_{xy} - \tau_{yx} + \frac{1}{2} \frac{\partial \tau_{xy}}{\partial x} dx - \frac{1}{2} \frac{\partial \tau_{yx}}{\partial y} dy \right] dx dy dz + C_z dx dy dz = \frac{1}{12} \rho dx dy dz (dx^2 + dy^2) \frac{d^2 \theta}{dt^2}$$

Reduce to third order terms and cancel  $(dx dy dz)$ :  $\tau_{yx} - \tau_{xy} = C_z$  Ans.

The concentrated couple allows the stress tensor to have unsymmetric shear stress terms.

**4.39** Problems involving viscous dissipation of energy are dependent on viscosity  $\mu$ , thermal conductivity  $k$ , stream velocity  $U_o$ , and stream temperature  $T_o$ . Group these parameters into the dimensionless *Brinkman number*, which is proportional to  $\mu$ .

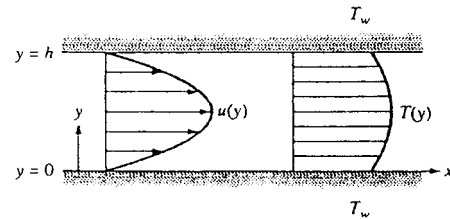
**Solution:** Using the primary dimensions as mass M, length L, and time T, we obtain

$$\text{Br} = \text{fcn}(\mu, k, U_o, T_o) = \mu k^a U_o^b T_o^c = \left\{ \frac{\text{M}}{\text{LT}} \right\} \left\{ \frac{\text{ML}}{\text{T}^3 \Theta} \right\}^a \left\{ \frac{\text{L}}{\text{T}} \right\}^b \{\Theta\}^c = \text{M}^0 \text{L}^0 \text{T}^0 \Theta^0$$

$$\text{Solve for } a = c = -1 \text{ and } b = +2. \text{ Hence: } \mathbf{Br} = \frac{\mu U_o^2}{k T_o} \text{ Ans.}$$

**4.40** As mentioned in Sec. 4.11, the velocity profile for laminar flow between two plates, as in Fig. P4.40, is

$$u = \frac{4u_{\max}y(h-y)}{h^2} \quad v = w = 0$$



**Fig. P4.40**

If the wall temperature is  $T_w$  at both walls, use the incompressible-flow energy equation (4.75) to solve for the temperature distribution  $T(y)$  between the walls for steady flow.

**Solution:** Assume  $T = T(y)$  and use the energy equation with the known  $u(y)$ :

$$\rho c_p \frac{DT}{dt} = k \frac{d^2T}{dy^2} + \mu \left( \frac{du}{dy} \right)^2, \quad \text{or: } \rho c_p (0) = k \frac{d^2T}{dy^2} + \mu \left[ \frac{4u_{\max}}{h^2} (h-2y) \right]^2, \quad \text{or:}$$

$$\frac{d^2T}{dy^2} = -\frac{16\mu u_{\max}^2}{kh^4} (h^2 - 4hy + 4y^2), \quad \text{Integrate: } \frac{dT}{dy} = \frac{-16\mu u_{\max}^2}{kh^4} \left( h^2 y - 2hy^2 + \frac{4y^3}{3} + C_1 \right)$$

Before integrating again, note that  $dT/dy = 0$  at  $y = h/2$  (the symmetry condition), so  $C_1 = -h^3/6$ . Now integrate once more:

$$T = -\frac{16\mu u_{\max}^2}{kh^4} \left( h^2 \frac{y^2}{2} - 2h \frac{y^3}{3} + \frac{y^4}{3} + C_1 y \right) + C_2$$

If  $T = T_w$  at  $y = 0$  and at  $y = h$ , then  $C_2 = T_w$ . The final solution is:

$$\mathbf{T = T_w + \frac{8\mu u_{\max}^2}{k} \left[ \frac{y}{3h} - \frac{y^2}{h^2} + \frac{4y^3}{3h^3} - \frac{2y^4}{3h^4} \right]} \text{ Ans.}$$

**4.41** The approximate velocity profile in Prob. 3.18 for steady laminar flow through a rectangular duct,

$$u = u_{\max} [1 - (y/b)^2] [1 - (z/h)^2]$$

satisfies the no-slip condition and gave a reasonable volume flow estimate (which was the point of Prob. 3.18). Show, however, that it does not satisfy the Navier-Stokes equation for duct flow with  $\partial p/\partial x$  equal to a negative constant. Extra credit: the EXACT solution!

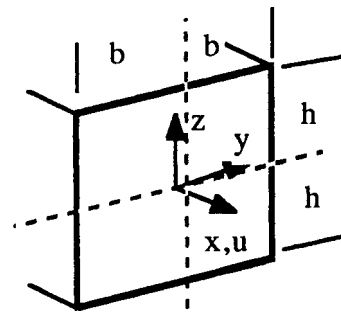


Fig. P4.41

**Solution:** The x-component of Navier-Stokes for fully-developed flow is

$$\mu \nabla^2 u(x, y) = \frac{\partial p}{\partial x} = \text{const} < 0 \quad (\text{no acceleration, neglect gravity})$$

But, in fact, the Laplacian of the above “u” approximation is NOT constant:

$$\nabla^2 u_{\text{approx}} = -\frac{2u_{\max}}{b^2} \left(1 - \frac{z^2}{h^2}\right) - \frac{2u_{\max}}{h^2} \left(1 - \frac{y^2}{b^2}\right) \neq \text{constant} \quad \text{Ans.}$$

It is *nearly* constant in the duct center (small y, z) but it is **not** exact. See Ref. 5, Ch. 4.

**4.42** Suppose that we wish to analyze the rotating, partly-full cylinder of Fig. 2.23 as a *spin-up* problem, starting from rest and continuing until solid-body-rotation is achieved. What are the appropriate boundary and initial conditions for this problem?

**Solution:** Let  $V = V(r, z, t)$ . The initial condition is:  $V(r, z, 0) = 0$ . The boundary conditions are

Along the side walls:  $v_\theta(R, z, t) = R\Omega$ ,  $v_r(R, z, t) = 0$ ,  $v_z(R, z, t) = 0$ .

At the bottom,  $z = 0$ :  $v_\theta(r, 0, t) = r\Omega$ ,  $v_r(r, 0, t) = 0$ ,  $v_z(r, 0, t) = 0$ .

At the free surface,  $z = \eta$ :  $p = p_{\text{atm}}$ ,  $\tau_{rz} = \tau_{\theta z} = 0$ .

**4.43** For the draining liquid film of Fig. P4.36, what are the appropriate boundary conditions (a) at the bottom  $y = 0$  and (b) at the surface  $y = h$ ?

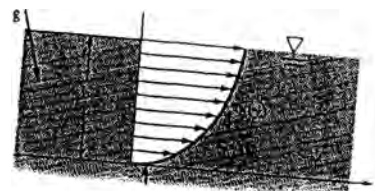


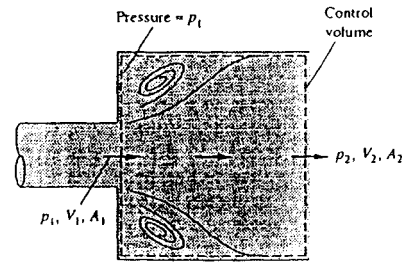
Fig. P4.36

**Solution:** The physically realistic conditions at the upper and lower surfaces are:

(a) at the bottom,  $y = 0$ , **no-slip:**  $\mathbf{u}(0) = \mathbf{0}$  *Ans.* (a)

(b) At the surface,  $y = h$ , no shear stress,  $\mu \frac{\partial u}{\partial y} = 0$ , or  $\frac{\partial \mathbf{u}}{\partial \mathbf{y}}(\mathbf{h}) = \mathbf{0}$  *Ans.* (b)

**4.44** Suppose that we wish to analyze the sudden pipe-expansion flow of Fig. P3.59, using the full continuity and Navier-Stokes equations. What are the proper boundary conditions to handle this problem?



**Fig. P3.59**

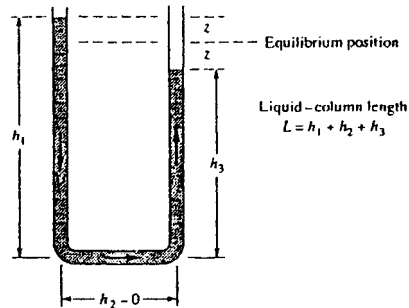
**Solution:** First, at all walls, one would impose the no-slip condition:  $\mathbf{u}_r = \mathbf{u}_z = \mathbf{0}$  at all solid surfaces: at  $r = r_1$  in the small pipe, at  $r = r_2$  in the large pipe, and also on the flat-faced surface between the two.

Second, at some position upstream in the small pipe, the complete velocity distribution must be known:  $\mathbf{u}_1 = \mathbf{u}_1(\mathbf{r})$  at  $z = z_1$ . [Possibly the *paraboloid* of Prob. 4.34.]

Third, to be strictly correct, at some position downstream in the large pipe, the complete velocity distribution must be known:  $\mathbf{u}_2 = \mathbf{u}_2(\mathbf{r})$  at  $z = z_2$ . In numerical (computer) studies, this is often simplified by using a “free outflow” condition,  $\partial \mathbf{u} / \partial z = 0$ .

Finally, the pressure must be specified at either the inlet or the outlet section of the flow, usually at the upstream section:  $\mathbf{p} = \mathbf{p}_1(\mathbf{r})$  at  $z = z_1$ .

**4.45** Suppose that we wish to analyze the U-tube oscillation flow of Fig. P3.96, using the full continuity and Navier-Stokes equations. What are the proper boundary conditions to handle this problem?



**Fig. P3.96**

**Solution:** This is an unsteady flow problem, so we need an initial condition at  $t = 0$ ,  $z(\text{left interface}) = z_0$ ,  $z(\text{right interface}) = -z_0$ :  $\mathbf{u}(\mathbf{r}, \mathbf{z}, \mathbf{0}) = \mathbf{0}$  everywhere in the fluid column.

Second, during the unsteady motion, we need boundary conditions of no-slip at the walls,  $\mathbf{u} = \mathbf{0}$  at  $\mathbf{r} = \mathbf{R}$ , and, if we neglect surface tension, known pressures at the two free surfaces:  $\mathbf{p} = \mathbf{p}_{\text{atmosphere}}$  at both ends. Finally, not knowing inlet or exit velocities, we would assume “free flow” at the interfaces:  $\partial \mathbf{u} / \partial z = 0$ .

**4.46** Fluid from a large reservoir at temperature  $T_o$  flows into a circular pipe of radius  $R$ . The pipe walls are wound with an electric-resistance coil which delivers heat to the fluid at a rate  $q_w$  (energy per unit wall area). If we wish to analyze this problem by using the full continuity, Navier-Stokes, and energy equations, what are the proper boundary conditions for the analysis?

**Solution:** Letting  $z = 0$  be the pipe entrance, we can state inlet conditions: typically  $u_z(r, 0) = U$  (a uniform inlet profile),  $u_r(r, 0) = 0$ , and  $T(r, 0) = T_o$ , also uniform.

At the wall,  $r = R$ , the no-slip and known-heat-flux conditions hold:  $u_z(R, z) = u_r(R, z) = 0$  and  $k(\partial T/\partial r) = q_w$  at  $(R, z)$  (assuming that  $q_w$  is positive for heat flow in).

At the exit,  $z = L$ , we would probably assume ‘free outflow’:  $\partial u_z/\partial z = \partial T/\partial z = 0$ .

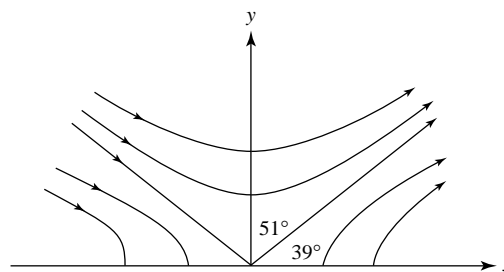
Finally, we would need to know the pressure at one point, probably the inlet,  $z = 0$ .

**4.47** Given the incompressible flow  $\mathbf{V} = 3y\mathbf{i} + 2x\mathbf{j}$ . Does this flow satisfy continuity? If so, find the stream function  $\psi(x, y)$  and plot a few streamlines, with arrows.

**Solution:** With  $u = 3y$  and  $v = 2x$ , we may check  $\partial u/\partial x + \partial v/\partial y = 0 + 0 = 0$ , OK. Find the streamlines from  $u = \partial\psi/\partial y = 3y$  and  $v = -\partial\psi/\partial x = 2x$ . Integrate to find

$$\psi = \frac{3}{2}y^2 - x^2 \quad \text{Ans.}$$

Set  $\psi = 0, \pm 1, \pm 2$ , etc. and plot some streamlines at right: flow around corners of half-angles  $39^\circ$  and  $51^\circ$ .



**Fig. P4.47**

**4.48** Consider the following two-dimensional incompressible flow, which clearly satisfies continuity:

$$u = U_o = \text{constant}, \quad v = V_o = \text{constant}$$

Find the stream function  $\psi(r, \theta)$  of this flow, that is, using *polar coordinates*.

**Solution:** In cartesian coordinates the stream function is quite easy:

$$u = \partial\psi/\partial y = U_o \quad \text{and} \quad v = -\partial\psi/\partial x = V_o \quad \text{or:} \quad \psi = U_o y - V_o x + \text{constant}$$

But, in polar coordinates,  $y = r\sin\theta$  and  $x = r\cos\theta$ . Therefore the desired result is

$$\psi(r, \theta) = U_o r \sin\theta - V_o r \cos\theta + \text{constant} \quad \text{Ans.}$$



**4.49** Investigate the stream function  $\psi = K(x^2 - y^2)$ ,  $K = \text{constant}$ . Plot the streamlines in the full  $xy$  plane, find any stagnation points, and interpret what the flow could represent.

**Solution:** The velocities are given by

$$u = \frac{\partial \psi}{\partial y} = -2Ky; \quad v = -\frac{\partial \psi}{\partial x} = -2Kx$$

This is also stagnation flow, with the streamlines turned  $45^\circ$  from Prob. 4.48.

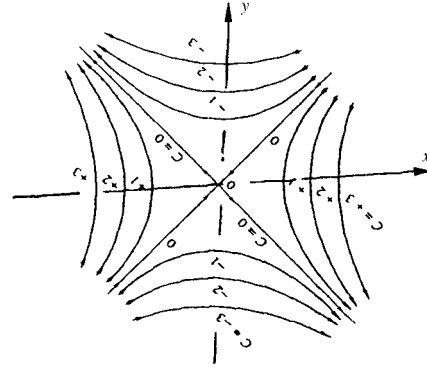


Fig. P4.49

**4.50** Investigate the polar-coordinate stream function  $\psi = Kr^{1/2} \sin \frac{1}{2} \theta$ ,  $K = \text{constant}$ . Plot the streamlines in the full  $xy$  plane, find any stagnation points, and interpret.

**Solution:** Simply set  $\psi/K = \text{constant}$  and plot  $r$  versus  $\theta$ . This represents inviscid flow around a  $180^\circ$  turn. [See Fig. 8.14(e) of the text.]

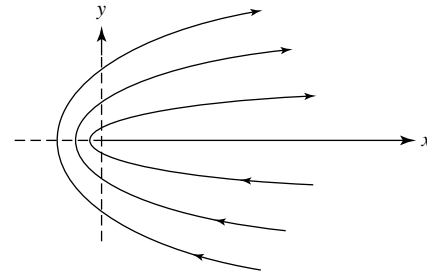


Fig. P4.50

**4.51** Investigate the polar-coordinate stream function  $\psi = Kr^{2/3} \sin(2\theta/3)$ ,  $K = \text{constant}$ . Plot the streamlines in all except the bottom right quadrant, and interpret.

**Solution:** Simply set  $\psi/K = \text{constant}$  and plot  $r$  versus  $\theta$ . This represents inviscid flow around a  $90^\circ$  turn. [See Fig. 8.14(d) of the text.]

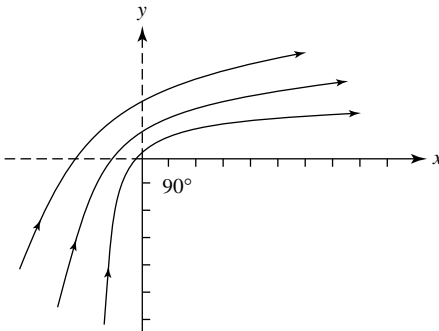


Fig. P4.51

**4.52** A two-dimensional, incompressible, frictionless fluid is guided by wedge-shaped walls into a small slot at the origin, as in Fig. P4.52. The width into the paper is  $b$ , and the volume flow rate is  $Q$ . At any given distance  $r$  from the slot, the flow is radial inward, with constant velocity. Find an expression for the polar-coordinate stream function of this flow.

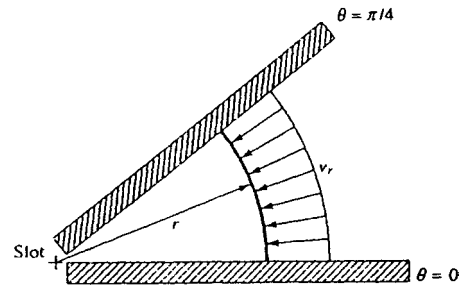


Fig. P4.52

**Solution:** We can find velocity from continuity:

$$v_r = -\frac{Q}{A} = -\frac{Q}{(\pi/4)rb} = \frac{1}{r} \frac{\partial \psi}{\partial \theta} \quad \text{from Eq. (4.101). Then}$$

$$\psi = -\frac{4Q}{\pi b} \theta + \text{constant} \quad \text{Ans.}$$

This is equivalent to the stream function for a line sink, Eq. (4.131).

**4.53** For the fully developed laminar-pipe-flow solution of Prob. 4.34, find the axisymmetric stream function  $\psi(r, z)$ . Use this result to determine the average velocity  $V = Q/A$  in the pipe as a ratio of  $u_{\max}$ .

**Solution:** The given velocity distribution,  $v_z = u_{\max}(1 - r^2/R^2)$ ,  $v_r = 0$ , satisfies continuity, so a stream function does exist and is found as follows:

$$v_z = u_{\max}(1 - r^2/R^2) = \frac{1}{r} \frac{\partial \psi}{\partial r}, \quad \text{solve for } \psi = u_{\max} \left( \frac{r^2}{2} - \frac{r^4}{4R^2} \right) + f(z), \quad \text{now use in}$$

$$v_r = 0 = -\frac{1}{r} \frac{\partial \psi}{\partial z} = 0 + \frac{df}{dz}, \quad \text{thus } f(z) = \text{const}, \quad \psi = u_{\max} \left( \frac{r^2}{2} - \frac{r^4}{4R^2} \right) \quad \text{Ans.}$$

We can find the flow rate and average velocity from the text for polar coordinates:

$$Q_{1-2} = 2\pi(\psi_2 - \psi_1), \quad \text{or: } Q_{0-R} = 2\pi \left[ u_{\max} \left( \frac{R^2}{2} - \frac{R^4}{4R^2} \right) - u_{\max}(0 - 0) \right] = \frac{\pi}{2} R^2 u_{\max}$$

$$\text{Then } V_{\text{avg}} = Q/A_{\text{pipe}} = [(\pi/2)R^2 u_{\max}/(\pi R^2)] = \frac{1}{2} u_{\max} \quad \text{Ans.}$$

**4.54** An incompressible stream function is defined by

$$\psi(x, y) = \frac{U}{L^2}(3x^2y - y^3)$$

where  $U$  and  $L$  are (positive) constants. Where in this chapter are the streamlines of this flow plotted? Use this stream function to find the volume flow  $Q$  passing through the rectangular surface whose corners are defined by  $(x, y, z) = (2L, 0, 0)$ ,  $(2L, 0, b)$ ,  $(0, L, b)$ , and  $(0, L, 0)$ . Show the direction of  $Q$ .

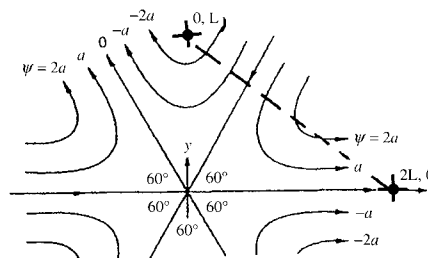


Fig. E4.7

**Solution:** This flow, with velocities  $u = \partial\psi/\partial y = 3U/L^2(x^2 - y^2)$ , and  $v = -\partial\psi/\partial x = -6xyU/L^2$ , is identical to Example 4.7 of the text, with “ $a$ ” =  $3U/L^2$ . The streamlines are plotted in Fig. E4.7. The volume flow per unit width between the points  $(2L, 0)$  and  $(0, L)$  is

$$Q/b = \psi(2L, 0) - \psi(0, L) = \frac{U}{L^2}(0 - 0) - \frac{U}{L^2}[3(0)^2L - L^3] = UL, \quad \text{or: } \mathbf{Q = ULb} \quad \text{Ans.}$$

Since  $\psi$  at the *lower* point  $(2L, 0)$  is larger than at the *upper* point  $(0, L)$ , the flow through this diagonal plane is to the left, as per Fig. 4.9 of the text.

**4.55** In spherical polar coordinates, as in Fig. P4.12, the flow is called *axisymmetric* if  $v_\theta \equiv 0$  and  $\partial/\partial\phi \equiv 0$ , so that  $v_r = v_r(r, \theta)$  and  $v_\theta = v_\theta(r, \theta)$ . Show that a stream function  $\psi(r, \theta)$  exists for this case and is given by

$$v_r = \frac{1}{r^2 \sin \theta} \frac{\partial \psi}{\partial \theta} \quad v_\theta = -\frac{1}{r \sin \theta} \frac{\partial \psi}{\partial r}$$

This is called the *Stokes stream function* [5, p. 204].

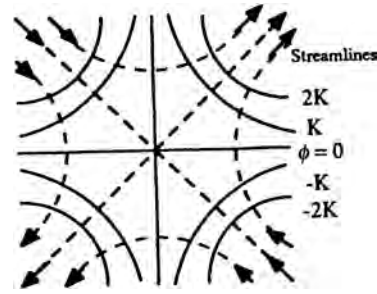
**Solution:** From Prob. 4.12 with zero velocity  $v_\phi$ , the continuity equation is

$$\frac{1}{r^2} \frac{\partial}{\partial r}(r^2 v_r) + \frac{1}{r \sin \theta} \frac{\partial}{\partial \theta}(v_\theta \sin \theta) = 0, \quad \text{or: } \frac{\partial}{\partial r}(r^2 v_r \sin \theta) + \frac{\partial}{\partial \theta}(r v_\theta \sin \theta) = 0$$

Compare this to a stream function cross-differentiated form  $\frac{\partial}{\partial r}\left(\frac{\partial \psi}{\partial \theta}\right) + \frac{\partial}{\partial \theta}\left(-\frac{\partial \psi}{\partial r}\right) = 0$

$$\text{It follows that: } \mathbf{v_r(Stokes) = \frac{1}{r^2 \sin \theta} \frac{\partial \psi}{\partial \theta}; \quad v_\theta(Stokes) = \frac{-1}{r \sin \theta} \frac{\partial \psi}{\partial r} \quad \text{Ans.}}$$

**4.56** Investigate the velocity potential  $\phi = Kxy$ ,  $K = \text{constant}$ . Sketch the potential lines in the full  $xy$  plane, find any stagnation points, and sketch in by eye the orthogonal streamlines. What could the flow represent?



**Fig. P4.56**

**Solution:** The potential lines,  $\phi = \text{constant}$ , are hyperbolas, as shown. The streamlines, sketched in as normal to the  $\phi$  lines, are also hyperbolas. The pattern represents plane stagnation flow (Prob. 4.48) turned at  $45^\circ$ .

**4.57** A two-dimensional incompressible flow field is defined by the velocity components

$$u = 2V \left( \frac{x}{L} - \frac{y}{L} \right) \quad v = -2V \frac{y}{L}$$

where  $V$  and  $L$  are constants. If they exist, find the stream function and velocity potential.

**Solution:** First check continuity and irrotationality:

$$\frac{\partial u}{\partial x} + \frac{\partial v}{\partial y} = \frac{2V}{L} - \frac{2V}{L} = 0 \quad \psi \text{ exists;}$$

$$\nabla \times \mathbf{V} = \mathbf{k} \left( \frac{\partial v}{\partial x} - \frac{\partial u}{\partial y} \right) = \mathbf{k} \left( 0 + \frac{2V}{L} \right) \neq 0 \quad \phi \text{ does not exist}$$

To find the stream function  $\psi$ , use the definitions of  $u$  and  $v$  and integrate:

$$u = \frac{\partial \psi}{\partial y} = 2V \left( \frac{x}{L} - \frac{y}{L} \right), \quad \therefore \psi = 2V \left( \frac{xy}{L} - \frac{y^2}{2L} \right) + f(x)$$

$$\text{Evaluate } \frac{\partial \psi}{\partial x} = \frac{2Vy}{L} + \frac{df}{dx} = -v = \frac{2Vy}{L}$$

$$\text{Thus } \frac{df}{dx} = 0 \quad \text{and} \quad \psi = V \left( \frac{2xy}{L} - \frac{y^2}{L} \right) + \text{const} \quad \text{Ans.}$$

**4.58** Show that the incompressible velocity potential in plane polar coordinates  $\phi(r, \theta)$  is such that

$$v_r = \frac{\partial \phi}{\partial r} \quad v_\theta = \frac{1}{r} \frac{\partial \phi}{\partial \theta}$$

Further show that the angular velocity about the  $z$  axis in such a flow would be given by

$$2\omega_z = \frac{1}{r} \frac{\partial}{\partial r}(rv_\theta) - \frac{1}{r} \frac{\partial}{\partial \theta}(v_r)$$

Finally show that  $\phi$  as defined satisfies Laplace's equation in polar coordinates for incompressible flow.

**Solution:** All of these things are quite true and easy to show from their definitions. *Ans.*

---

**4.59** Consider the two-dimensional incompressible velocity potential  $\phi = xy + x^2 - y^2$ . (a) Is it true that  $\nabla^2\phi = 0$ , and, if so, what does this mean? (b) If it exists, find the stream function  $\psi(x, y)$  of this flow. (c) Find the equation of the streamline which passes through  $(x, y) = (2, 1)$ .

**Solution:** (a) First check that  $\nabla^2\phi = 0$ , which means that **incompressible continuity is satisfied**.

$$\nabla^2\phi = \frac{\partial^2\phi}{\partial x^2} + \frac{\partial^2\phi}{\partial y^2} = 0 + 2 - 2 = 0 \quad \text{Yes}$$

(b) Now use  $\phi$  to find  $u$  and  $v$  and then integrate to find  $\psi$ .

$$u = \frac{\partial\phi}{\partial x} = y + 2x = \frac{\partial\psi}{\partial y}, \quad \text{hence } \psi = \frac{y^2}{2} + 2xy + f(x)$$

$$v = \frac{\partial\phi}{\partial y} = x - 2y = -\frac{\partial\psi}{\partial x} = -2y - \frac{df}{dx}, \quad \text{hence } f(x) = -\frac{x^2}{2} + \text{const}$$

The final stream function is thus  $\psi = \frac{1}{2}(y^2 - x^2) + 2xy + \text{const}$  *Ans.* (b)

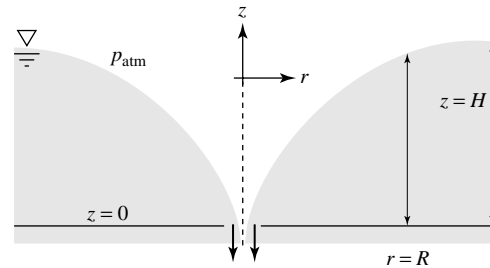
(c) The streamline which passes through  $(x, y) = (2, 1)$  is found by setting  $\psi =$  a constant:

$$\text{At } (x, y) = (2, 1), \quad \psi = \frac{1}{2}(1^2 - 2^2) + 2(2)(1) = -\frac{3}{2} + 4 = \frac{5}{2}$$

Thus the proper streamline is  $\psi = \frac{1}{2}(y^2 - x^2) + 2xy = \frac{5}{2}$  *Ans.* (c)

---

**4.60** Liquid drains from a small hole in a tank, as shown in Fig. P4.60, such that the velocity field set up is given by  $v_r \approx 0$ ,  $v_z \approx 0$ ,  $v_\theta = \omega R^2/r$ , where  $z = H$  is the depth of the water far from the hole. Is this flow pattern rotational or irrotational? Find the depth  $z_0$  of the water at the radius  $r = R$ .



**Fig. P4.60**

**Solution:** From App. D, the angular velocity is

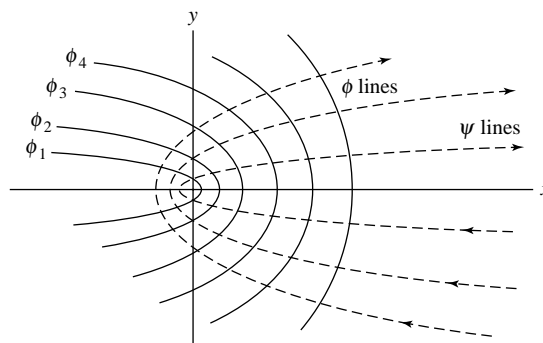
$$\omega_z = \frac{1}{r} \frac{\partial}{\partial r} (r v_\theta) - \frac{1}{r} \frac{\partial}{\partial \theta} (v_r) = 0 \quad (\text{IRROTATIONAL})$$

Incompressible continuity is valid for this flow, hence Bernoulli's equation holds at the surface, where  $p = p_{\text{atm}}$ , both at infinity and at  $r = R$ :

$$p_{\text{atm}} + \frac{1}{2} \rho V_{r=\infty}^2 + \rho g H = p_{\text{atm}} + \frac{1}{2} \rho V_{r=R}^2 + \rho g z_0$$

Introduce  $V_{r=\infty} = 0$  and  $V_{r=R} = \omega R$  to obtain  $z_0 = H - \frac{\omega^2 R^2}{2g}$  Ans.

**4.61** Investigate the polar-coordinate velocity potential  $\phi = Kr^{1/2} \cos \frac{1}{2} \theta$ ,  $K = \text{constant}$ . Plot the potential lines in the full  $xy$  plane, sketch in by eye the orthogonal streamlines, and interpret.



**Fig. P4.61**

**Solution:** These are the  $\phi$  lines associated with the  $180^\circ$ -turn streamlines from Prob. 4.50.

**4.62** Show that the linear Couette flow between plates in Fig. 1.6 has a stream function but no velocity potential. Why is this so?

**Solution:** Given  $u = Vy/h$ ,  $v = 0$ , check continuity:

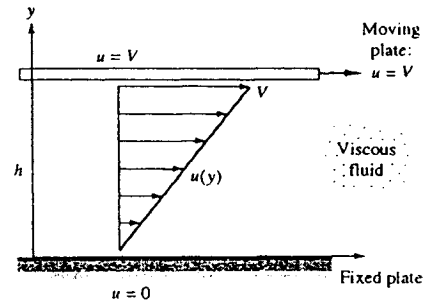


Fig. 1.6

$$\frac{\partial u}{\partial x} + \frac{\partial v}{\partial y} \stackrel{?}{=} 0 = 0 + 0 \quad (\text{Satisfied therefore } \psi \text{ exists}). \text{ Find } \psi \text{ from}$$

$$u = \frac{Vy}{h} = \frac{\partial \psi}{\partial y}, \quad v = 0 = -\frac{\partial \psi}{\partial x}, \quad \text{solve for } \psi = \frac{V}{2h}y^2 + \text{const} \quad \text{Ans.}$$

Now check irrotationality:

$$2\omega_z = \frac{\partial v}{\partial x} - \frac{\partial u}{\partial y} \stackrel{?}{=} 0 = 0 - \frac{V}{h} \neq 0! \quad (\text{Rotational, } \phi \text{ does not exist.}) \quad \text{Ans.}$$

**4.63** Find the two-dimensional velocity potential  $\phi(r, \theta)$  for the polar-coordinate flow pattern  $v_r = Q/r$ ,  $v_\theta = K/r$ , where  $Q$  and  $K$  are constants.

**Solution:** Relate these velocity components to the polar-coordinate definition of  $\phi$ :

$$v_r = \frac{Q}{r} = \frac{\partial \phi}{\partial r}, \quad v_\theta = \frac{K}{r} = \frac{1}{r} \frac{\partial \phi}{\partial \theta}; \quad \text{solve for } \phi = Q \ln(r) + K\theta + \text{const} \quad \text{Ans.}$$

**4.64** Show that the velocity potential  $\phi(r, z)$  in axisymmetric cylindrical coordinates (see Fig. 4.2 of the text) is defined by the formulas:

$$v_r = \frac{\partial \phi}{\partial r} \quad v_z = \frac{\partial \phi}{\partial z}$$

Further show that for incompressible flow this potential satisfies Laplace's equation in  $(r, z)$  coordinates.

**Solution:** All of these things are quite true and are easy to show from their definitions. *Ans.*

**4.65** A two-dimensional incompressible flow is defined by

$$u = -\frac{Ky}{x^2 + y^2} \quad v = \frac{Kx}{x^2 + y^2}$$

where  $K = \text{constant}$ . Is this flow irrotational? If so, find its velocity potential, sketch a few potential lines, and interpret the flow pattern.

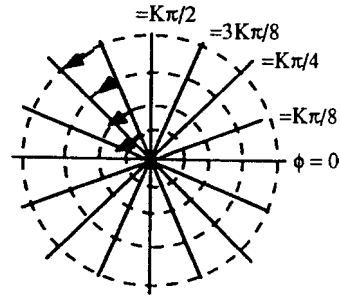


Fig. P4.65

**Solution:** Evaluate the angular velocity:

$$2\omega_z = \frac{\partial v}{\partial x} - \frac{\partial u}{\partial y} = \frac{K}{x^2 + y^2} - \frac{2Kx^2}{(x^2 + y^2)^2} + \frac{K}{x^2 + y^2} - \frac{2Ky^2}{(x^2 + y^2)^2} = \mathbf{0 \text{ (Irrotational)}}$$
 Ans.

Introduce the definition of velocity potential and integrate to get  $\phi(x, y)$ :

$$u = \frac{\partial \phi}{\partial x} = -\frac{Ky}{x^2 + y^2}; \quad v = \frac{\partial \phi}{\partial y} = \frac{Kx}{x^2 + y^2}, \quad \text{solve for } \phi = \mathbf{K \tan^{-1}\left(\frac{y}{x}\right) = K\theta}$$
 Ans.

The  $\phi$  lines are plotted above. They represent a counterclockwise line vortex.

**4.66** A plane polar-coordinate velocity potential is defined by

$$\phi = \frac{K \cos \theta}{r} \quad K = \text{const}$$

Find the stream function for this flow, sketch some streamlines and potential lines, and interpret the flow pattern.

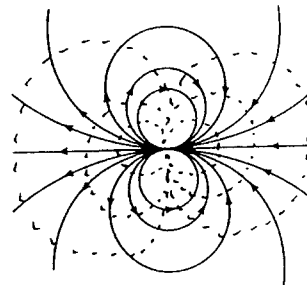


Fig. P4.66

**Solution:** Evaluate the velocities and thence find the stream function:

$$v_r = \frac{\partial \phi}{\partial r} = -\frac{K \cos \theta}{r^2} = \frac{1}{r} \frac{\partial \psi}{\partial \theta}; \quad v_\theta = \frac{1}{r} \frac{\partial \phi}{\partial \theta} = -\frac{K \sin \theta}{r^2} = -\frac{\partial \psi}{\partial r},$$

$$\text{solve } \psi = -\frac{\mathbf{K \sin \theta}}{r} \text{ Ans.}$$

The streamlines and potential lines are shown above. This pattern is a line doublet.



**4.67** A stream function for a plane, irrotational, polar-coordinate flow is

$$\psi = C\theta - K \ln r \quad C \text{ and } K = \text{const}$$

Find the velocity potential for this flow. Sketch some streamlines and potential lines, and interpret the flow pattern.

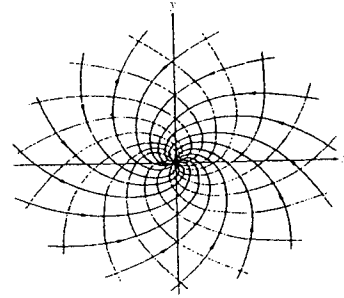


Fig. 4.14

**Solution:** If this problem is given *early* enough (before Section 4.10 of the text), the students will discover this pattern for themselves. It is a line source plus a line vortex, a tornado-like flow, Eq. (4.134) and Fig. 4.14 of the text. Find the velocity potential:

$$v_r = \frac{1}{r} \frac{\partial \psi}{\partial \theta} = \frac{C}{r} = \frac{\partial \phi}{\partial r}; \quad v_\theta = -\frac{\partial \psi}{\partial r} = \frac{K}{r} = \frac{1}{r} \frac{\partial \phi}{\partial \theta}, \quad \text{solve } \phi = C \ln(r) + K\theta \quad \text{Ans.}$$

The streamlines and potential lines are plotted above for *negative*  $C$  (a line sink).

**4.68** Find the stream function and plot some streamlines for the combination of a line source  $m$  at  $(x, y) = (0, +a)$  and an equal line source placed at  $(0, -a)$ .

**Solution:** In the spirit of Eq. (4.133), we add two *sources* together:

$$\begin{aligned} \psi &= \text{Source @ } (0, a) + \text{Source @ } (0, -a) \\ &= m \tan^{-1}\left(\frac{y-a}{x}\right) + m \tan^{-1}\left(\frac{y+a}{x}\right) \end{aligned}$$

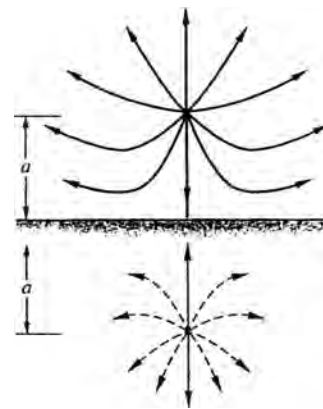


Fig. P4.68

Use the identity  $\tan^{-1}\alpha + \tan^{-1}\beta = \tan^{-1}\left(\frac{\alpha + \beta}{1 - \alpha\beta}\right)$  to get

$$\psi = m \tan^{-1}\left(\frac{2xy}{x^2 - y^2 + a^2}\right) \quad \text{Ans.}$$

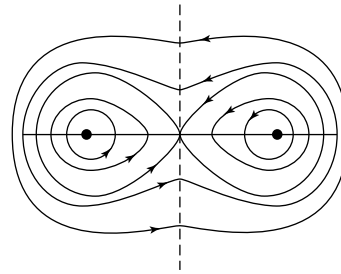
The latter form uses the trig identity  $\tan^{-1}\alpha + \tan^{-1}\beta = \tan^{-1}[(\alpha + \beta)/(1 - \alpha\beta)]$ . If we plot lines of constant  $\psi$  (streamlines), we find the source-flow *image* pattern shown above.

**4.69** Find the stream function and plot some streamlines for the combination of a counterclockwise line vortex  $K$  at  $(x, y) = (+a, 0)$  and an equal line vortex placed at  $(-a, 0)$ .

**Solution:** The combined stream function is

$$\psi = -K \ln r_1 - K \ln r_2 = -K \ln[(x-a)^2 + y^2]^{1/2} - K \ln[(x+a)^2 + y^2]^{1/2}$$

Plotting this, for various  $K = \text{constant}$ , reveals the “cat’s-eye” pattern shown at right.



**4.70** Take the limit of  $\phi$  for the source-sink combination, Eq. (4.133), as strength  $m$  becomes large and distance  $a$  becomes small, so that  $(ma) = \text{constant}$ . What happens?

**Solution:** Given  $\phi = \frac{1}{2}m \ln\left\{\frac{(x+a)^2 + y^2}{(x-a)^2 + y^2}\right\}$ , divide [] by  $(x+a)^2$  and use the series form  $\ln\left[\frac{1+\varepsilon}{1-\varepsilon}\right] = 2\varepsilon + \frac{2\varepsilon^3}{3} + \dots$  the result is the *line doublet*:

$$\phi_{\text{doublet}} = \lim_{am=0} (\phi_{\text{source+sink}}) = \frac{2amx}{x^2 + y^2} = \frac{\lambda \cos\theta}{r^2}, \quad \lambda = 2am \quad \text{Ans.}$$

**4.71** Find the stream function and plot some streamlines for the combination of a counterclockwise line vortex  $K$  at  $(x, y) = (+a, 0)$  and an opposite (clockwise) line vortex placed at  $(-a, 0)$ .

**Solution:** The combined stream function is

$$\psi = -K \ln r_1 + K \ln r_2 = -K \ln[(x-a)^2 + y^2]^{1/2} + K \ln[(x+a)^2 + y^2]^{1/2}$$

Plotting this, for various  $K = \text{constant}$ , reveals the swirling “vortex-pair” pattern shown at right. It is equivalent to an “image” vortex pattern, as in Fig. 8.17(b) of the text.

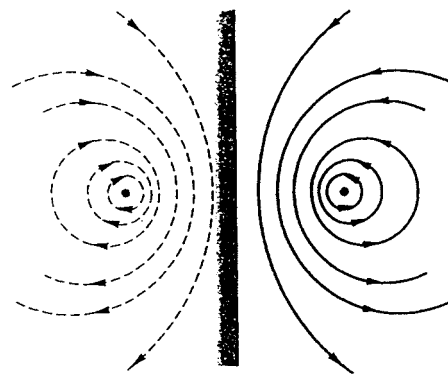


Fig. P4.71

**4.72** A coastal power plant takes in cooling water through a vertical perforated manifold, as in Fig. P4.72. The total volume flow intake is  $110 \text{ m}^3/\text{s}$ . Currents of  $25 \text{ cm/s}$  flow past the manifold, as shown. Estimate (a) how far downstream and (b) how far normal to the paper the effects of the intake are felt in the ambient 8-m-deep waters.

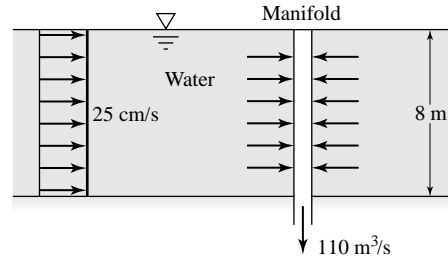


Fig. P4.72

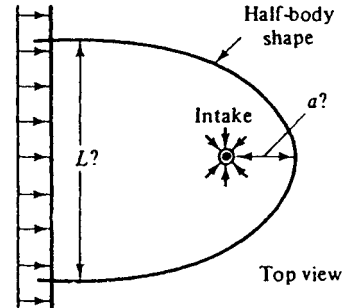
**Solution:** A top view of the flow is shown at right. The sink strength is

$$m = \frac{Q}{2\pi b} = \frac{110 \text{ m}^3/\text{s}}{2\pi(8 \text{ m})} = 2.19 \frac{\text{m}^2}{\text{s}}$$

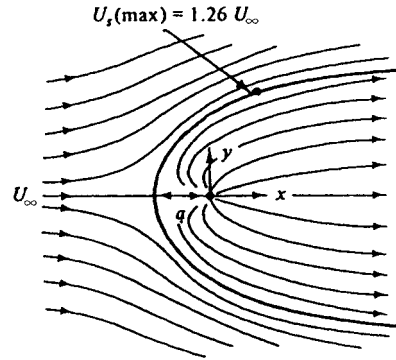
Then the appropriate lengths are:

$$a = \frac{m}{U} = \frac{2.19 \text{ m}^2/\text{s}}{0.25 \text{ m/s}} = \mathbf{8.75 \text{ m}} \quad \text{Ans. (a)}$$

$$L = 2\pi a = 2\pi(8.75) = \mathbf{55 \text{ m}} \quad \text{Ans. (b)}$$



**4.73** A two-dimensional Rankine half-body, 8 cm thick, is placed in a water tunnel at  $20^\circ\text{C}$ . The water pressure far upstream along the body centerline is  $120 \text{ kPa}$ . What is the nose radius of the half-body? At what tunnel flow velocity will cavitation bubbles begin to form on the surface of the body?



**Solution:** The nose radius is given by

$$a = \frac{L}{2\pi} = \frac{8 \text{ cm}}{2\pi} = \mathbf{1.27 \text{ cm}} \quad \text{Ans.}$$

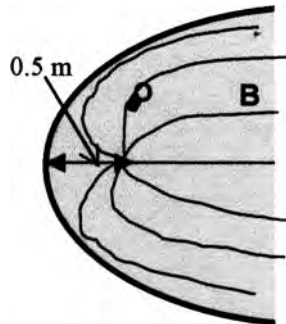
At  $20^\circ\text{C}$  the vapor pressure of water is  $2337 \text{ Pa}$ . Maximum velocity occurs, as shown, on the upper surface at  $\theta \approx 63^\circ$ , where  $z \approx 2.04a \approx 2.6 \text{ cm}$  and  $V \approx 1.26U_\infty$ . Write the Bernoulli equation between upstream and  $V$ , assuming the surface pressure is vaporizing:

$$p_\infty + \frac{\rho}{2} U_\infty^2 + \rho g z_\infty \approx p_{\text{vap}} + \frac{\rho}{2} V_{\text{max}}^2 + \rho g z_{\text{surface}}$$

$$\text{or: } 120000 + \frac{998}{2} U_\infty^2 + 0 = 2337 + \frac{998}{2} (1.26 U_\infty)^2 + 9790(0.026),$$

$$\text{solve } U_\infty \approx 20 \frac{\text{m}}{\text{s}} \quad \text{Ans.}$$

**4.74** A small fish pond is approximated by a half-body shape, as shown in Fig. P4.74. Point O, which is 0.5 m from the left edge of the pond, is a water source delivering about  $0.63 \text{ m}^3/\text{s}$  per meter of depth into the paper. Find the point B along the axis where the water velocity is approximately 25 cm/s.



**Fig. P4.74**

**Solution:** We are given  $a = 0.5 \text{ m}$  and  $Q = 0.63 \text{ m}^3/\text{s}$ , hence the source strength from Eq. (4.131) is  $m = Q/(2\pi b) = (0.63 \text{ m}^3/\text{s})/[2\pi(1 \text{ m})] = 0.1003 \text{ m}^2/\text{s}$ . The stream velocity is thus

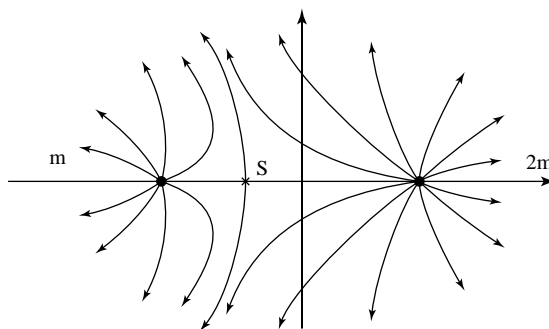
$$U = m/a = (0.1003 \text{ m}^2/\text{s})/(0.5 \text{ m}) = 0.2005 \text{ m/s}$$

Along line OB, the velocity is purely radial. We find point B from the known velocity:

$$V_B = 0.25 \text{ m/s} = U + \frac{m}{r_{OB}} = 0.2005 + \frac{0.1003}{r_{OB}},$$

$$\text{hence } r_{OB} = 2.03 \text{ m} \quad \text{Ans.}$$

**4.75** Find the stream function and plot some streamlines for the combination of a line source  $2m$  at  $(x, y) = (+a, 0)$  and a line source  $m$  at  $(-a, 0)$ . Are there any stagnation points in the flow field?



**Fig. P4.75**

**Solution:** The combined stream function is

$$\psi = 2m \tan^{-1}\left(\frac{y}{x-a}\right) + m \tan^{-1}\left(\frac{y}{x+a}\right)$$

The streamlines, viewed from up close, look like the drawing on the previous page. There is one stagnation point, where  $2m/r_1 = m/r_2$ , or at  $(x, y) = (-a/3, 0)$ . Viewed from afar, they look like the radial streamlines of a single source of strength  $3m$ .

**4.76** Air flows at 1.2 m/s along a flat wall when it meets a jet of air issuing from a slot at A. The jet volume flow is  $0.4 \text{ m}^3/\text{s}$  per m of width into the paper. If the jet is approximated as a line source, (a) locate the stagnation point S. (b) How far vertically will the jet flow extend?

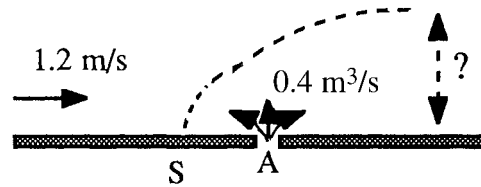
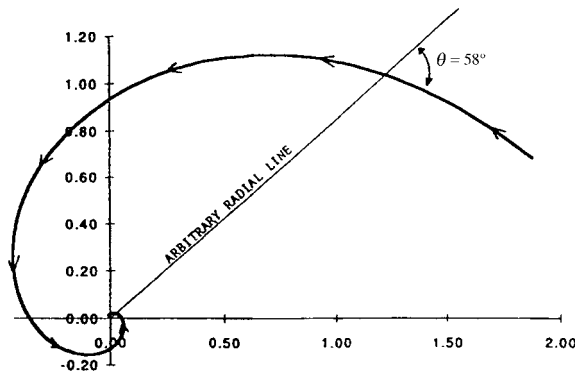


Fig. P4.76

**Solution:** The equivalent source strength is  $m = 0.4/\pi = 0.127 \text{ m}^2/\text{s}$ . Then, as in Figure 4.15 of the text, the stagnation point S is at  $a = m/U = 0.127/1.2 = \mathbf{0.106 \text{ m}}$  from A. The effective ‘half-body,’ shown as a dashed line in the figure, extends out to a distance equal to  $\pi a = \pi(0.106) = \mathbf{0.333 \text{ m}}$  above the wall. *Ans.*

**4.77** A tornado is simulated by a line sink  $m = -1000 \text{ m}^2/\text{s}$  plus a line vortex  $K = +1600 \text{ m}^2/\text{s}$ . Find the angle between any streamline and a radial line, and show that it is independent of both  $r$  and  $\theta$ . If this tornado forms in sea-level standard air, at what radius will the local pressure be equivalent to 29 inHg?



**Solution:** The combined stream function is

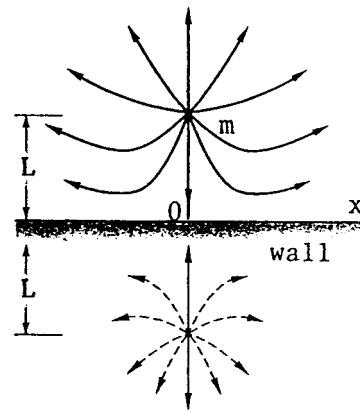
$$\psi = -K \ln(r) - m\theta, \text{ with the angle } \phi \text{ given by}$$

$$\tan \phi = |v_\theta/v_r| = \frac{K/r}{m/r} = \frac{K}{m} = 1.6 \text{ independent of } r, \theta$$

$$\text{The desired angle is } \phi = \tan^{-1}(1.6) \approx 58^\circ \text{ Ans.}$$

Local pressure = 29"Hg = 98 kPa at  $V = 75$  m/s, or  $r = 25$  meters. Ans.

**4.78** We wish to study the flow due to a line source of strength  $m$  placed at position  $(x, y) = (0, +L)$ , above the plane horizontal wall  $y = 0$ . Using Bernoulli's equation, find (a) the point(s) of minimum pressure on the plane wall and (b) the magnitude of the maximum flow velocity along the wall.



**Solution:** The "wall" is produced by an image source at  $(0, -L)$ , as in Prob. 4.68. Along the wall,  $y = 0$ ,  $v = 0$ ,  $U = m/L$ ,

$$u = 2u_{\text{one source}} = \frac{2UL}{(x^2 + L^2)^{1/2}} \cdot \frac{x}{(x^2 + L^2)^{1/2}} = \frac{2ULx}{x^2 + L^2}$$

By differentiation, the maximum velocity occurs at  $x = L$ , or  $u_{\text{max}} = U = \frac{m}{L}$  Ans. (b)

By Bernoulli's equation, this is also the point of minimum pressure, at  $(x, y) = (L, 0)$ :

$$p_{\text{min}} = p(0, 0) - \frac{1}{2} \rho u_{\text{max}}^2 = p_0 - \frac{1}{2} \rho (m/L)^2 \text{ at } (\pm L, 0) \text{ Ans. (a)}$$

**4.79** Study the combined effect of the two viscous flows in Fig. 4.16. That is, find  $u(y)$  when the upper plate moves at speed  $V$  and there is also a constant pressure gradient  $(dp/dx)$ . Is superposition possible? If so, explain why. Plot representative velocity profiles for (a) zero, (b) positive, and (c) negative pressure gradients for the same upper-wall speed  $V$ .

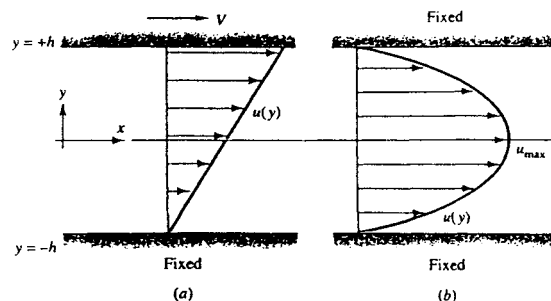


Fig. 4.16

**Solution:** The combined solution is

$$u = \frac{V}{2} \left( 1 + \frac{y}{h} \right) + \frac{h^2}{2\mu} \left( -\frac{dp}{dx} \right) \left( 1 - \frac{y^2}{h^2} \right)$$

The superposition is quite valid because the convective acceleration is zero, hence what remains is linear:  $\nabla p = \mu \nabla^2 \mathbf{V}$ . Three representative velocity profiles are plotted at right for various  $(dp/dx)$ .

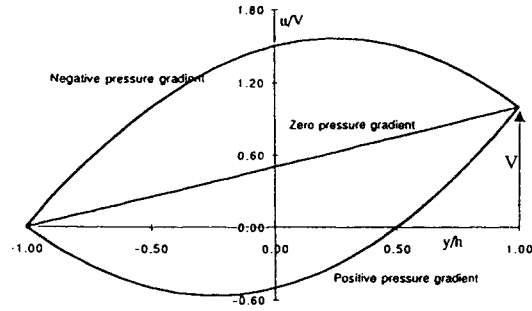
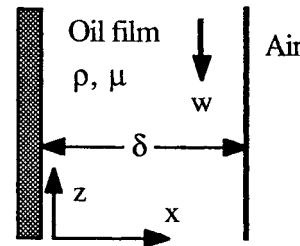


Fig. P4.79

**4.80** An oil film drains steadily down the side of a vertical wall, as shown. After an initial development at the top of the wall, the film becomes independent of  $z$  and of constant thickness. Assume that  $w = w(x)$  only that the atmosphere offers no shear resistance to the film. (a) Solve Navier-Stokes for  $w(x)$ . (b) Suppose that film thickness and  $[\partial w/\partial x]$  at the wall are measured. Find an expression which relates  $\mu$  to this slope  $[\partial w/\partial x]$ .



**Solution:** First, there is no pressure gradient  $\partial p/\partial z$  because of the constant-pressure atmosphere. The Navier-Stokes  $z$ -component is  $\mu d^2w/dx^2 = \rho g$ , and the solution requires  $w = 0$  at  $x = 0$  and  $(dw/dx) = 0$  (no shear at the film edge) at  $x = \delta$ . The solution is:

$$w = \frac{\rho g x}{2\mu} (x - 2\delta) \quad \text{Ans. (a) NOTE: } w \text{ is negative (down)}$$

The wall slope is  $\frac{dw}{dx} \Big|_{\text{wall}} = -\frac{\rho g \delta}{\mu}$ , or rearrange:  $\mu = -\frac{\rho g \delta}{[dw/dx]_{\text{wall}}}$  Ans. (b)

**4.81** Modify the analysis of Fig. 4.17 to find the velocity  $v_\theta$  when the inner cylinder is fixed and the outer cylinder rotates at angular velocity  $\Omega_0$ . May this solution be added to Eq. (4.146) to represent the flow caused when both inner and outer cylinders rotate? Explain your conclusion.

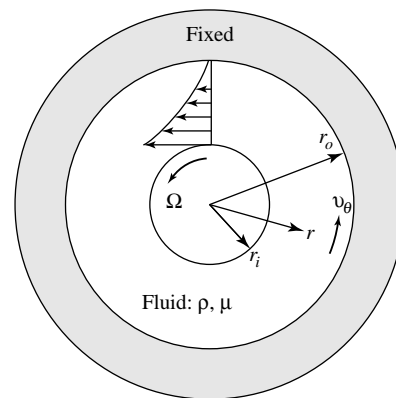


Fig. 4.17

**Solution:** We apply new boundary conditions to Eq. (4.145) of the text:

$$v_\theta = C_1 r + C_2/r;$$

At  $r = r_i, v_\theta = 0 = C_1 r_i + C_2/r_i$

$$\text{At } r = r_0, \quad v_\theta = \Omega_0 r_0 = C_1 r_0 + C_2 / r_0$$

$$\text{Solve for } C_1 \text{ and } C_2. \text{ The final result: } \mathbf{v}_\theta = \Omega_0 \mathbf{r}_0 \left( \frac{r/r_1 - r_1/r}{r_0/r_1 - r_1/r_0} \right) \text{ Ans.}$$

This solution may indeed be added to the inner-rotation solution, Eq. (4.146), because the convective acceleration is zero and hence the Navier-Stokes equation is *linear*.

**4.82** A solid circular cylinder of radius  $R$  rotates at angular velocity  $\Omega$  in a viscous incompressible fluid which is at rest far from the cylinder, as in Fig. P4.82. Make simplifying assumptions and derive the governing differential equation and boundary conditions for the velocity field  $v_\theta$  in the fluid. Do not solve unless you are obsessed with this problem. What is the steady-state flow field for this problem?

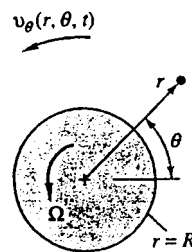


Fig. P4.82

**Solution:** We assume purely circulating motion:  $v_z = v_r = 0$  and  $\partial/\partial\theta = 0$ . Thus the remaining variables are  $v_\theta = \text{fcn}(r, t)$  and  $p = \text{fcn}(r, t)$ . Continuity is satisfied identically, and the  $\theta$ -momentum equation reduces to a partial differential equation for  $v_\theta$ :

$$\frac{\partial v_\theta}{\partial t} = \frac{\mu}{\rho} \left[ \frac{1}{r} \frac{\partial}{\partial r} \left( r \frac{\partial v_\theta}{\partial r} \right) - \frac{v_\theta}{r^2} \right] \quad \text{subject to } v_\theta(R, t) = \Omega R \quad \text{and} \quad v_\theta(\infty, t) = 0 \quad \text{Ans.}$$

I am not obsessed with this problem so will not attempt to find a solution. However, at large times, or  $t = \infty$ , the steady state solution is  $\mathbf{v}_\theta = \Omega R^2 / r$ . Ans.

**4.83** The flow pattern in bearing lubrication can be illustrated by Fig. P4.83, where a viscous oil ( $\rho, \mu$ ) is forced into the gap  $h(x)$  between a fixed slipper block and a wall moving at velocity  $U$ . If the gap is thin,  $h \ll L$ , it can be shown that the pressure and velocity distributions are of the form  $p = p(x)$ ,  $u = u(y)$ ,  $v = w = 0$ . Neglecting gravity, reduce the Navier-Stokes equations (4.38) to a single differential equation for  $u(y)$ . What are the proper boundary conditions? Integrate and show that

$$u = \frac{1}{2\mu} \frac{dp}{dx} (y^2 - yh) + U \left( 1 - \frac{y}{h} \right)$$

where  $h = h(x)$  may be an arbitrary slowly varying gap width. (For further information on lubrication theory, see Ref. 16.)



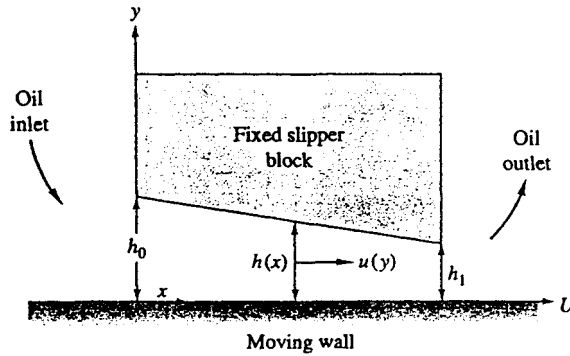


Fig. P4.83

**Solution:** With  $u = u(y)$  and  $p = p(x)$  only in the gap, the  $x$ -momentum equation becomes

$$\rho \frac{du}{dt} = 0 = -\frac{dp}{dx} + \mu \frac{\partial^2 u}{\partial y^2}, \quad \text{or:} \quad \frac{d^2 u}{dy^2} = \frac{1}{\mu} \frac{dp}{dx} = \text{constant}$$

Integrate twice:  $u = \frac{1}{\mu} \frac{dp}{dx} \frac{y^2}{2} + C_1 y + C_2$ , with  $u(0) = U$  and  $u(h) = 0$

With  $C_1$  and  $C_2$  evaluated, the solution is exactly as listed in the problem statement:

$$u = \frac{1}{2\mu} \frac{dp}{dx} (y^2 - yh) + U \left( 1 - \frac{y}{h} \right) \quad \text{Ans.}$$

**4.84** Consider a viscous film of liquid draining uniformly down the side of a vertical rod of radius  $a$ , as in Fig. P4.84. At some distance down the rod the film will approach a terminal or *fully developed* draining flow of constant outer radius  $b$ , with  $v_z = v_z(r)$ ,  $v_\theta = v_r = 0$ . Assume that the atmosphere offers no shear resistance to the film motion. Derive a differential equation for  $v_z$ , state the proper boundary conditions, and solve for the film velocity distribution. How does the film radius  $b$  relate to the total film volume flow rate  $Q$ ?

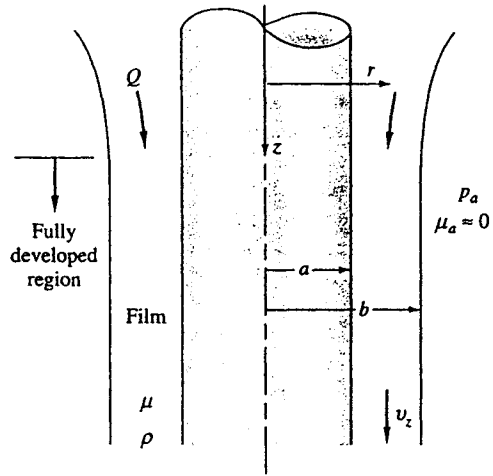


Fig. P4.84

**Solution:** With  $v_z = \text{fcn}(r)$  only, the Navier-Stokes  $z$ -momentum relation is

$$\rho \frac{dv_z}{dt} = 0 = -\frac{\partial p}{\partial z} + \rho g + \mu \nabla^2 v_z,$$

or:  $\frac{1}{r} \frac{d}{dr} \left( r \frac{dv_z}{dr} \right) = -\frac{\rho g}{\mu}$ , Integrate twice:  $v_z = -\frac{\rho g r^2}{4\mu} + C_1 \ln(r) + C_2$

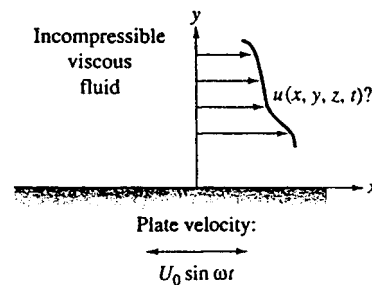
The proper B.C. are:  $u(a) = 0$  (no-slip) and  $\mu \frac{\partial v_z}{\partial r}(b) = 0$  (no free-surface shear stress)

The final solution is  $v_z = \frac{\rho g b^2}{2\mu} \ln\left(\frac{r}{a}\right) - \frac{\rho g}{4\mu} (r^2 - a^2)$  *Ans.*

The flow rate is  $Q = \int_a^b v_z 2\pi r dr = \frac{\pi \rho g a^4}{8\mu} (-3\sigma^4 - 1 + 4\sigma^2 + 4\sigma^4 \ln \sigma)$ ,

where  $\sigma = \frac{b}{a}$  *Ans.*

**4.85** A flat plate of essentially infinite width and breadth oscillates sinusoidally in its own plane beneath a viscous fluid, as in Fig. P4.85. The fluid is at rest far above the plate. Making as many simplifying assumptions as you can, set up the governing differential equation and boundary conditions for finding the velocity field  $u$  in the fluid. Do not solve (if you *can* solve it immediately, you might be able to get exempted from the balance of this course with credit).



**Fig. P4.85**

**Solution:** Assume  $u = u(y, t)$  and  $\partial p / \partial x = 0$ . The  $x$ -momentum relation is

$$\rho \left( \frac{\partial u}{\partial t} + u \frac{\partial u}{\partial x} + v \frac{\partial u}{\partial y} \right) = -\frac{\partial p}{\partial x} + \rho g_x + \mu \left( \frac{\partial^2 u}{\partial x^2} + \frac{\partial^2 u}{\partial y^2} \right),$$

or:  $\rho \left( \frac{\partial u}{\partial t} + 0 + 0 \right) = 0 + 0 + \mu \left( 0 + \frac{\partial^2 u}{\partial y^2} \right)$ , or, finally:

$$\frac{\partial u}{\partial t} = \frac{\mu}{\rho} \frac{\partial^2 u}{\partial y^2} \quad \text{subject to: } \mathbf{u}(0, t) = U_0 \sin(\omega t) \quad \text{and} \quad \mathbf{u}(\infty, t) = \mathbf{0}. \quad \text{Ans.}$$

**4.86** SAE 10 oil at 20°C flows between parallel plates 8 mm apart, as in Fig. P4.86. A mercury manometer, with wall pressure taps 1 m apart, registers a 6-cm height, as shown. Estimate the flow rate of oil for this condition.

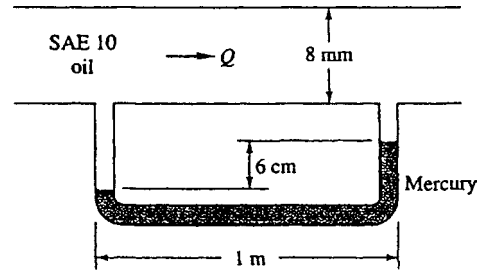


Fig. P4.86

**Solution:** Assuming laminar flow, this geometry fits Eqs. (4.143, 144) of the text:

$$V_{\text{avg}} = \frac{2}{3} u_{\text{max}} = \left( \frac{dp}{dx} \right) \frac{h^2}{3\mu}, \quad \text{where } h = \text{plate half-width} = 4 \text{ mm}$$

For SAE 10W oil, take  $\rho = 870 \text{ kg/m}^3$  and  $\mu = 0.104 \text{ kg/m}\cdot\text{s}$ . The manometer reads

$$\Delta p = (\rho_{\text{Hg}} - \rho_{\text{oil}})g\Delta h = (13550 - 870)(9.81)(0.06) \approx 7463 \text{ Pa} \quad \text{for } \Delta x = L = 1 \text{ m}$$

$$\text{Then } V = \frac{\Delta p}{\Delta x} \frac{h^2}{3\mu} = \left( \frac{7463 \text{ Pa}}{1 \text{ m}} \right) \frac{(0.004)^2}{3(0.104)} \approx 0.383 \frac{\text{m}}{\text{s}}$$

$$\text{The flow rate per unit width is } Q = VA = (0.383)(0.008) \approx \mathbf{0.00306} \frac{\text{m}^3}{\text{s}\cdot\text{m}} \quad \text{Ans.}$$

**4.87** SAE 30W oil at 20°C flows through the 9-cm-diameter pipe in Fig. P4.87 at an average velocity of 4.3 m/s. (a) Verify that the flow is laminar. (b) Determine the volume flow rate in  $\text{m}^3/\text{h}$ . (c) Calculate the expected reading  $h$  of the mercury manometer, in cm.

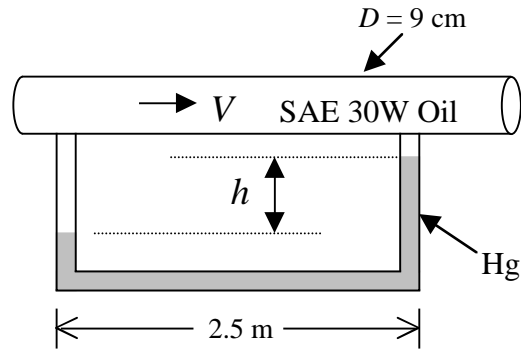


Fig. P4.87

**Solution:** (a) Check the Reynolds number. For SAE 30W oil, from Appendix A.3,  $\rho = 891 \text{ kg/m}^3$  and  $\mu = 0.29 \text{ kg/(m}\cdot\text{s)}$ . Then

$$Re_d = \rho Vd/\mu = (891 \text{ kg/m}^3)(4.3 \text{ m/s})(0.09 \text{ m})/[0.29 \text{ kg/(m}\cdot\text{s)}] = 1190 < 2000 \text{ Laminar} \quad \text{Ans. (a)}$$

(b) With average velocity known, the volume flow follows easily:

$$Q = AV = [(\pi/4)(0.09 \text{ m})^2](4.3 \text{ m/s})(3600 \text{ s/h}) = \mathbf{98.5 \text{ m}^3/\text{h}} \quad \text{Ans. (b)}$$

(c) The manometer measures the pressure drop over a 2.5 m length of pipe. From Eq. (4.147),

$$V = 4.3 \frac{m}{s} = \frac{\Delta p R^2}{L 8\mu} = \frac{\Delta p}{2.5 \text{ m}} \frac{(0.045 \text{ m})^2}{8(0.29 \text{ kg/m}\cdot\text{s})}, \text{ solve for } \Delta p = 12320 \text{ Pa}$$

$$\Delta p_{mano} = 12320 = (\rho_{merc} - \rho_{oil})gh = (13550 - 891)(9.81)h, \text{ Solve } \mathbf{h = 0.099 \text{ m}} \quad \text{Ans. (c)}$$

**4.88** The viscous oil in Fig. P4.88 is set into steady motion by a concentric inner cylinder moving axially at velocity  $U$  inside a fixed outer cylinder. Assuming constant pressure and density and a purely axial fluid motion, solve Eqs. (4.38) for the fluid velocity distribution  $v_z(r)$ . What are the proper boundary conditions?

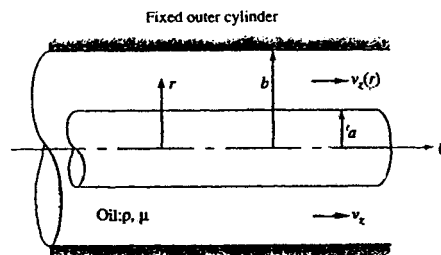


Fig. P4.88

**Solution:** If  $v_z = \text{fcn}(r)$  only, the  $z$ -momentum equation (Appendix E) reduces to:

$$\rho \frac{dv_z}{dt} = -\frac{\partial p}{\partial z} + \rho g_z + \mu \nabla^2 v_z, \quad \text{or: } 0 = 0 + 0 + \frac{\mu}{r} \frac{d}{dr} \left( r \frac{dv_z}{dr} \right)$$

The solution is  $v_z = C_1 \ln(r) + C_2$ , subject to  $v_z(a) = U$  and  $v_z(b) = 0$

$$\text{Solve for } C_1 = U/\ln(a/b) \quad \text{and} \quad C_2 = -C_1 \ln(b)$$

$$\text{The final solution is: } \mathbf{v_z = U \frac{\ln(r/b)}{\ln(a/b)}} \quad \text{Ans.}$$

**4.89** Modify Prob. 4.88 so that the outer cylinder also moves to the *left* at constant speed  $V$ . Find the velocity distribution  $v_z(r)$ . For what ratio  $V/U$  will the wall shear stress be the same at both cylinder surfaces?

**Solution:** We merely modify the boundary conditions for the known solution in 4.88:

$$v_z = C_1 \ln(r) + C_2, \quad \text{subject to } v_z(a) = U \quad \text{and} \quad v_z(b) = -V$$

$$\text{Solve for } C_1 = (U + V)/\ln(a/b) \quad \text{and} \quad C_2 = U - (U + V)\ln(a)/\ln(a/b)$$

$$\text{The final solution is } \mathbf{v_z = U + (U + V) \frac{\ln(r/a)}{\ln(a/b)}} \quad \text{Ans.}$$

The shear stress  $\tau = \mu(U + V)/[r \ln(a/b)]$  and is never equal at both walls for any ratio of  $V/U$  unless the clearance is vanishingly small, that is, unless  $a \approx b$ . *Ans.*

**4.90** SAE 10W oil at 20°C flows through a straight horizontal pipe. The pressure gradient is a constant 400 Pa/m. (a) What is the appropriate pipe diameter  $D$  in cm if the Reynolds number  $Re_D$  of the flow is to be exactly 1000? (b) For case  $a$ , what is the flow rate  $Q$  in  $m^3/h$ ?

**Solution:** For SAE 10W oil, from Appendix A.3,  $\rho = 870 \text{ kg/m}^3$  and  $\mu = 0.104 \text{ kg/(m}\cdot\text{s)}$ .  
 (a) Relate  $V_{\text{avg}}$  to pressure drop from Eq. (4.147) and set the Reynolds number equal to 1000:

$$Re_D = \frac{\rho}{\mu} VD = \frac{\rho}{\mu} \left[ \frac{\Delta p}{L} \frac{R^2}{8\mu} \right] D = 1000 = \frac{870 \text{ kg/m}^3}{0.104 \text{ kg/m}\cdot\text{s}} \left[ 400 \frac{\text{Pa}}{\text{m}} \left\{ \frac{(D/2)^2}{8(0.104)} \right\} \right] D$$

$$= 1.005E6 D^3$$

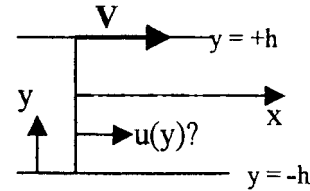
Solve for  $D \approx 0.100 \text{ m}$  Ans. (a)

(b) Use your value for  $D$  to calculate

$$V = (\Delta p/L)(D/2)^2/8\mu = (400)(0.050)^2/[8(0.104)] = 1.20 \text{ m/s.}$$

Then  $Q = AV = [(\pi/4)(0.100 \text{ m})^2](1.20 \text{ m/s})(3600 \text{ s/h}) = 34 \text{ m}^3/\text{h}$  Ans. (b)

**4.91** Consider 2-D incompressible steady Couette flow between parallel plates with the upper plate moving at speed  $V$ , as in Fig. 4.16a. Let the fluid be *nonnewtonian*, with stress given by



$$\tau_{xx} = a \left( \frac{\partial u}{\partial x} \right)^c \quad \tau_{yy} = a \left( \frac{\partial v}{\partial y} \right)^c \quad \tau_{xy} = \tau_{yx} = \frac{a}{2} \left( \frac{\partial u}{\partial y} + \frac{\partial v}{\partial x} \right)^c, \quad a \text{ and } c \text{ are constants}$$

Make all the same assumptions as in the derivation of Eq. (4.140). (a) Find the velocity profile  $u(y)$ . (b) How does the velocity profile for this case compare to that of a newtonian fluid?

**Solution:** (a) Neglect gravity and pressure gradient. If  $u = u(y)$  and  $v = 0$  at both walls, then continuity specifies that  $v = 0$  everywhere. Start with the  $x$ -momentum equation:

$$\rho \left( u \frac{\partial u}{\partial x} + v \frac{\partial u}{\partial y} \right) = \rho g_x - \frac{\partial p}{\partial x} + \frac{\partial \tau_{xx}}{\partial x} + \frac{\partial \tau_{xy}}{\partial y}$$

Many terms drop out because  $v = 0$  and  $\tau_{xx}$  and  $\partial u/\partial x = 0$  (because  $u$  does not vary with  $x$ ). Thus we only have

$$\frac{\partial \tau_{xy}}{\partial y} = \frac{d}{dy} \left[ \frac{a}{2} \left( \frac{du}{dy} \right)^c \right] = 0, \quad \text{or:} \quad \frac{du}{dy} = \text{constant}, \quad u = C_1 y + C_2$$

The boundary conditions are no-slip at both walls:

$$u(y = -h) = 0 = C_1(-h) + C_2; \quad u(y = +h) = V = C_1(+h) + C_2, \quad \text{solve} \quad C_1 = \frac{V}{2h}, \quad C_2 = \frac{V}{2}$$

The final solution for the velocity profile is:

$$u(y) = \frac{V}{2h} y + \frac{V}{2} \quad \text{Ans. (a)}$$

This is **exactly the same** as Eq. (4.140) for the newtonian fluid! *Ans. (b)*

**4.92** A tank of area  $A_o$  is draining in laminar flow through a pipe of diameter  $D$  and length  $L$ , as shown in Fig. P4.92. Neglecting the exit-jet kinetic energy and assuming the pipe flow is driven by the hydrostatic pressure at its entrance, derive a formula for the tank level  $h(t)$  if its initial level is  $h_o$ .

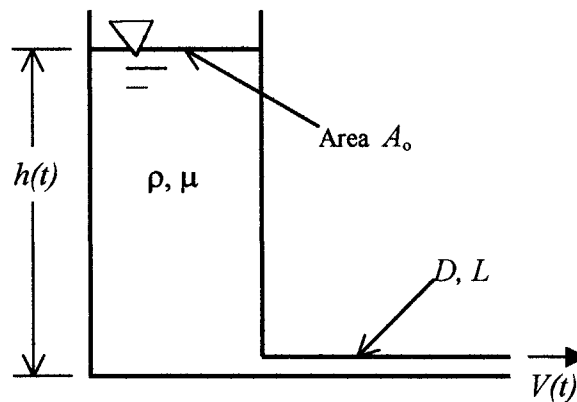


Fig. P4.92

**Solution:** For laminar flow, the flow rate out is given by Eq. (4.147). A control volume mass balance shows that this flow out is balanced by a tank level decrease:

$$Q_{out} = \frac{\pi D^4}{128 \mu L} \frac{\Delta p}{L} = -A \frac{dh}{dt} \quad \text{where} \quad \Delta p \approx \rho g h(t)$$

Thus we can separate the variables and integrate to find the tank level change:

$$\int_{h_o}^h \frac{dh}{h} = - \int_0^t \frac{\pi D^4 \rho g}{128 \mu L A_o} dt, \quad \text{or:} \quad h = h_o \exp \left[ - \frac{\pi D^4 \rho g}{128 \mu L A_o} t \right] \quad \text{Ans.}$$

**4.93** A number of straight 25-cm-long microtubes, of diameter  $d$ , are bundled together into a “honeycomb” whose total cross-sectional area is  $0.0006 \text{ m}^2$ . The pressure drop from entrance to exit is 1.5 kPa. It is desired that the total volume flow rate be  $1 \text{ m}^3/\text{h}$  of water at  $20^\circ\text{C}$ . (a) What is the appropriate microtube diameter? (b) How many microtubes are in the bundle? (c) What is the Reynolds number of each microtube?

**Solution:** For water at  $20^\circ\text{C}$ ,  $\rho = 998 \text{ kg/m}^3$  and  $\mu = 0.001 \text{ kg/m}\cdot\text{s}$ . Each microtube of diameter  $D$  sees the same pressure drop. If there are  $N$  tubes,

$$Q = \frac{1}{3600} \frac{\text{m}^3}{\text{s}} = N Q_{\text{tube}} = N \frac{\pi D^4 \Delta p}{128 \mu L} = N \frac{\pi D^4 (1500 \text{ Pa})}{128 (0.001 \text{ kg/m}\cdot\text{s}) (0.25 \text{ m})} = 1.47E5 N D^4$$

$$\text{At the same time, } N = A_{\text{bundle}}/A_{\text{tube}} = \frac{0.0006 \text{ m}^2}{(\pi/4)D^2}$$

Combine to find  $D^2 = 2.47E-6 \text{ m}^2$  or  $D = 0.00157 \text{ m}$  and  $N = 310$  Ans. (a, b)

With  $D$  known, compute  $V = Q/A_{\text{bundle}} = Q_{\text{tube}}/A_{\text{tube}} = 0.462 \text{ m/s}$  and

$$\text{Re}_D = \rho V D / \mu = (998)(0.462)(0.00157)/(0.001) = 724 \text{ (laminar)} \quad \text{Ans. (c)}$$


---

**FUNDAMENTALS OF ENGINEERING EXAM PROBLEMS: Answers**

Chapter 4 is not a favorite of the people who prepare the FE Exam. Probably not a single problem from this chapter will appear on the exam, but if some did, they might be like these:

FE4.1 Given the steady, incompressible velocity distribution  $\mathbf{V} = 3x\mathbf{i} + Cy\mathbf{j} + 0\mathbf{k}$ , where  $C$  is a constant, if conservation of mass is satisfied, the value of  $C$  should be

- (a) 3 (b) 3/2 (c) 0 (d) -3/2 (e) -3

FE4.2 Given the steady velocity distribution  $\mathbf{V} = 3x\mathbf{i} + 0\mathbf{j} + Cy\mathbf{k}$ , where  $C$  is a constant, if the flow is irrotational, the value of  $C$  should be

- (a) 3 (b) 3/2 (c) 0 (d) -3/2 (e) -3

FE4.3 Given the steady, incompressible velocity distribution  $\mathbf{V} = 3x\mathbf{i} + Cy\mathbf{j} + 0\mathbf{k}$ , where  $C$  is a constant, the shear stress  $\tau_{xx}$  at the point  $(x, y, z)$  is given by

- (a)  $3\mu$  (b)  $(3x + Cy)\mu$  (c) 0 (d)  $C\mu$  (e)  $(3 + C)\mu$



## COMPREHENSIVE PROBLEMS

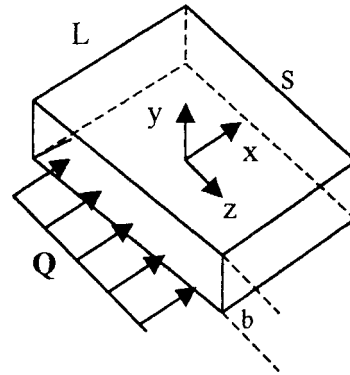
**C4.1** In a certain medical application, water at room temperature and pressure flows through a rectangular channel of length  $L = 10$  cm, width  $s = 1$  cm, and gap thickness  $b = 0.3$  mm. The volume flow is sinusoidal, with amplitude  $Q_o = 0.5$  ml/s and frequency  $f = 20$  Hz, that is,  $Q = Q_o \sin(2\pi f t)$ .

- (a) Calculate the maximum Reynolds number  $Re = Vb/\nu$ , based on maximum average velocity and gap thickness. Channel flow remains *laminar* for  $Re < 2000$ , otherwise it will be *turbulent*. Is this flow laminar or turbulent?
- (b) Assume quasi-steady flow, that is, solve as if the flow were steady at any given  $Q(t)$ . Find an expression for streamwise velocity  $u$  as a function of  $y$ ,  $\mu$ ,  $dp/dx$ , and  $b$ , where  $dp/dx$  is the pressure gradient required to drive the flow through the channel at flow rate  $Q$ . Also estimate the maximum magnitude of velocity component  $u$ .
- (c) Find an analytic expression for flow rate  $Q(t)$  as a function of  $dp/dx$ .
- (d) Estimate the wall shear stress  $\tau_w$  as a function of  $Q$ ,  $f$ ,  $\mu$ ,  $b$ ,  $s$ , and time  $t$ .
- (e) Finally, use the given numbers to estimate the wall shear amplitude,  $\tau_{wo}$ , in Pa.

**Solution:** (a) Maximum flow rate is the amplitude,  $Q_o = 0.5$  ml/s, hence average velocity  $V = Q/A$ :

$$V = \frac{Q}{bs} = \frac{0.5E-6 \text{ m}^3/\text{s}}{(0.0003 \text{ m})(0.01 \text{ m})} = 0.167 \text{ m/s}$$

$$Re_{\max} = \frac{Vb}{\nu} = \frac{(0.167)(0.0003)}{(0.001/998)} = 50 \text{ (laminar)} \quad \text{Ans. (a)}$$



(b, c) The quasi-steady analysis is just like Eqs. (4.142–144) of the text, with “ $h$ ” =  $b/2$ :

$$u = \frac{-1}{2\mu} \frac{dp}{dx} \left( \frac{b^2}{4} - y^2 \right), \quad u_{\max} = \frac{-1}{2\mu} \frac{dp}{dx} \frac{b^2}{4}, \quad Q_{\max} = \frac{2}{3} u_{\max} bs = \frac{-sb^3}{12\mu} \frac{dp}{dx} \quad \text{Ans. (b, c)}$$

(d) Wall shear:  $\tau_{\text{wall}} = \mu \left. \frac{du}{dy} \right|_{\text{wall}} = \frac{b}{2} \frac{dp}{dx} = \frac{6\mu Q}{sb^2} = \frac{6\mu Q_o}{sb^2} \sin(2\pi f t) \quad \text{Ans. (d)}$

(e) For our given numerical values, the amplitude of wall shear stress is:

$$\tau_{wo} = \frac{6\mu Q_o}{sb^2} = \frac{6(0.001)(0.5E-6)}{(0.01)(0.0003)^2} = 3.3 \text{ Pa} \quad \text{Ans. (e)}$$

**C4.2** A belt moves upward at velocity  $V$ , dragging a film of viscous liquid of thickness  $h$ , as in Fig. C4.2. Near the belt, the film moves upward due to no-slip. At its outer edge, the film moves downward due to gravity. Assuming that the only non-zero velocity is  $v(x)$ , with zero shear stress at the outer film edge, derive a formula for (a)  $v(x)$ ; (b) the average velocity  $V_{\text{avg}}$  in the film; and (c) the wall velocity  $V_C$  for which there is no net flow either up or down. (d) Sketch  $v(x)$  for case (c).

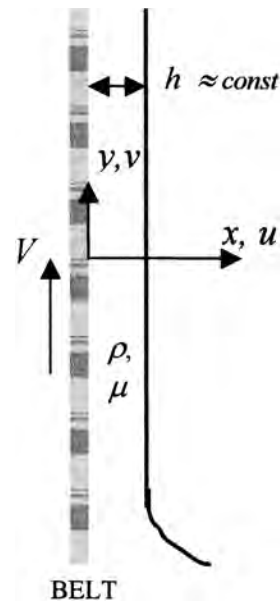


Fig. C4.2

**Solution:** (a) The assumption of parallel flow,  $u = w = 0$  and  $v = v(x)$ , satisfies continuity and makes the  $x$ - and  $z$ -momentum equations irrelevant. We are left with the  $y$ -momentum equation:

$$\rho \left( u \frac{\partial v}{\partial x} + v \frac{\partial v}{\partial y} + w \frac{\partial v}{\partial z} \right) = - \frac{\partial p}{\partial y} - \rho g + \mu \left( \frac{\partial^2 v}{\partial x^2} + \frac{\partial^2 v}{\partial y^2} + \frac{\partial^2 v}{\partial z^2} \right)$$

There is no convective acceleration, and the pressure gradient is negligible due to the free surface. We are left with a second-order linear differential equation for  $v(x)$ :

$$\frac{d^2 v}{dx^2} = \frac{\rho g}{\mu} \quad \text{Integrate: } \frac{dv}{dx} = \frac{\rho g}{\mu} x + C_1 \quad \text{Integrate again: } v = \frac{\rho g}{\mu} \frac{x^2}{2} + C_1 x + C_2$$

At the free surface,  $x = h$ ,  $\tau = \mu(dv/dx) = 0$ , hence  $C_1 = -\rho g h / \mu$ . At the wall,  $v = V = C_2$ . The solution is

$$v = V - \frac{\rho g h}{\mu} x + \frac{\rho g}{2\mu} x^2 \quad \text{Ans. (a)}$$

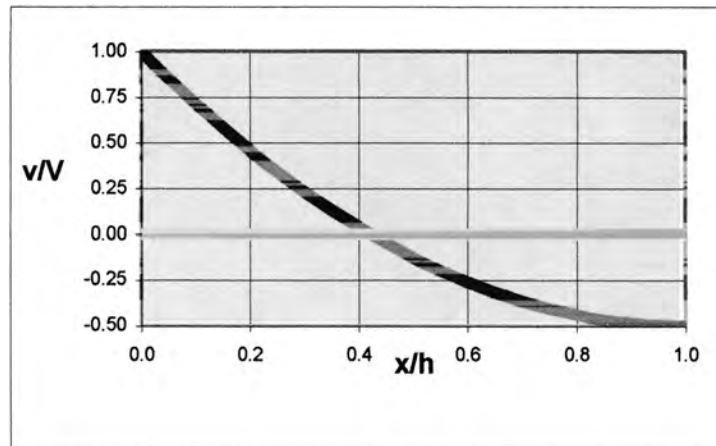
(b) The average velocity is found by integrating the distribution  $v(x)$  across the film:

$$v_{\text{avg}} = \frac{1}{h} \int_0^h v(x) dx = \frac{1}{h} \left[ Vx - \frac{\rho g h x^2}{2\mu} + \frac{\rho g x^3}{6\mu} \right]_0^h = V - \frac{\rho g h^2}{3\mu} \quad \text{Ans. (b)}$$

(c) Since  $h v_{\text{avg}} \equiv Q$  per unit depth into the paper, there is no net up-or-down flow when

$$V = \rho g h^2 / (3\mu) \quad \text{Ans. (c)}$$

(d) A graph of case (c) is shown below. *Ans.* (d)



## Chapter 5 • Dimensional Analysis and Similarity

**5.1** For axial flow through a circular tube, the Reynolds number for transition to turbulence is approximately 2300 [see Eq. (6.2)], based upon the diameter and average velocity. If  $d = 5$  cm and the fluid is kerosene at  $20^\circ\text{C}$ , find the volume flow rate in  $\text{m}^3/\text{h}$  which causes transition.

**Solution:** For kerosene at  $20^\circ\text{C}$ , take  $\rho = 804$   $\text{kg}/\text{m}^3$  and  $\mu = 0.00192$   $\text{kg}/\text{m}\cdot\text{s}$ . The only unknown in the transition Reynolds number is the fluid velocity:

$$\text{Re}_{\text{tr}} \approx 2300 = \frac{\rho V d}{\mu} = \frac{(804)V(0.05)}{0.00192}, \quad \text{solve for } V = 0.11 \text{ m/s}$$

$$\text{Then } Q = VA = (0.11) \frac{\pi}{4} (0.05)^2 = 2.16\text{E-}4 \frac{\text{m}^3}{\text{s}} \times 3600 \approx \mathbf{0.78} \frac{\text{m}^3}{\text{hr}} \quad \text{Ans.}$$

---

**5.2** In flow past a thin flat body such as an airfoil, transition to turbulence occurs at about  $\text{Re} = 1\text{E}6$ , based on the distance  $x$  from the leading edge of the wing. If an airplane flies at 450 mi/h at 8-km standard altitude and undergoes transition at the 12 percent chord position, how long is its chord (wing length from leading to trailing edge)?

**Solution:** From Table A-6 at  $z = 8000$  m,  $\rho \approx 0.525$   $\text{kg}/\text{m}^3$ ,  $T \approx 236^\circ\text{K}$ , hence  $\mu \approx 1.53\text{E-}5$   $\text{kg}/\text{m}\cdot\text{s}$ . Convert  $U = 450$  mi/hr  $\approx 201$  m/s. Then the transition Reynolds no. is

$$\text{Re}_{x,\text{tr}} = \frac{\rho U x_{\text{tr}}}{\mu} = 10^6 = \frac{(0.525)(201)(0.12C)}{1.53\text{E-}5}, \quad \text{solve for } C \approx \mathbf{1.21} \text{ m} \quad \text{Ans.}$$

---

**5.3** An airplane has a chord length  $L = 1.2$  m and flies at a Mach number of 0.7 in the standard atmosphere. If its Reynolds number, based on chord length, is  $7\text{E}6$ , how high is it flying?

**Solution:** This is harder than Prob. 5.2 above, for we have to search in the U.S. Standard Atmosphere (Table A-6) to find the altitude with the right density and viscosity

and speed of sound. We can make a first guess of  $T \approx 230 \text{ K}$ ,  $a \approx \sqrt{(kRT)} \approx 304 \text{ m/s}$ ,  $U = 0.7a \approx 213 \text{ m/s}$ , and  $\mu \approx 1.51\text{E-}5 \text{ kg/m}\cdot\text{s}$ . Then our first estimate for density is

$$\text{Re}_C = 7\text{E}6 = \frac{\rho UC}{\mu} \approx \frac{\rho(213)(1.2)}{1.51\text{E-}5}, \quad \text{or } \rho \approx 0.44 \text{ kg/m}^3 \quad \text{and } Z \approx 9500 \text{ m (Table A-6)}$$

Repeat and the process converges to  $\rho \approx 0.41 \text{ kg/m}^3$  or  $Z \approx 10100 \text{ m}$  Ans.

**5.4** When tested in water at  $20^\circ\text{C}$  flowing at  $2 \text{ m/s}$ , an  $8\text{-cm}$ -diameter sphere has a measured drag of  $5 \text{ N}$ . What will be the velocity and drag force on a  $1.5\text{-m}$ -diameter weather balloon moored in sea-level standard air under dynamically similar conditions?

**Solution:** For water at  $20^\circ\text{C}$  take  $\rho \approx 998 \text{ kg/m}^3$  and  $\mu \approx 0.001 \text{ kg/m}\cdot\text{s}$ . For sea-level standard air take  $\rho \approx 1.2255 \text{ kg/m}^3$  and  $\mu \approx 1.78\text{E-}5 \text{ kg/m}\cdot\text{s}$ . The balloon velocity follows from *dynamic similarity*, which requires identical Reynolds numbers:

$$\text{Re}_{\text{model}} = \frac{\rho V D}{\mu} \Big|_{\text{model}} = \frac{998(2.0)(0.08)}{0.001} = 1.6\text{E}5 = \text{Re}_{\text{proto}} = \frac{1.2255 V_{\text{balloon}}(1.5)}{1.78\text{E-}5}$$

or  $V_{\text{balloon}} \approx 1.55 \text{ m/s}$ . Then the two spheres will have identical drag coefficients:

$$C_{D,\text{model}} = \frac{F}{\rho V^2 D^2} = \frac{5 \text{ N}}{998(2.0)^2 (0.08)^2} = 0.196 = C_{D,\text{proto}} = \frac{F_{\text{balloon}}}{1.2255(1.55)^2 (1.5)^2}$$

Solve for  $F_{\text{balloon}} \approx 1.3 \text{ N}$  Ans.

**5.5** An automobile has a characteristic length and area of  $8 \text{ ft}$  and  $60 \text{ ft}^2$ , respectively. When tested in sea-level standard air, it has the following measured drag force versus speed:

V, mi/h:	20	40	60
Drag, lbf:	31	115	249

The same car travels in Colorado at  $65 \text{ mi/h}$  at an altitude of  $3500 \text{ m}$ . Using dimensional analysis, estimate (a) its drag force and (b) the horsepower required to overcome air drag.

**Solution:** For sea-level air in BG units, take  $\rho \approx 0.00238 \text{ slug/ft}^3$  and  $\mu \approx 3.72\text{E-}7 \text{ slug/ft}\cdot\text{s}$ . Convert the raw drag and velocity data into dimensionless form:

V (mi/hr):	20	40	60
$C_D = F/(\rho V^2 L^2)$ :	0.237	0.220	0.211
$\text{Re}_L = \rho V L / \mu$ :	1.50E6	3.00E6	4.50E6

Drag coefficient plots versus Reynolds number in a very smooth fashion and is well fit (to  $\pm 1\%$ ) by the Power-law formula  $C_D \approx 1.07\text{Re}_L^{-0.106}$ .

(a) The new velocity is  $V = 65 \text{ mi/hr} = 95.3 \text{ ft/s}$ , and for air at 3500-m Standard Altitude (Table A-6) take  $\rho = 0.001675 \text{ slug/ft}^3$  and  $\mu = 3.50\text{E-}7 \text{ slug/ft}\cdot\text{s}$ . Then compute the new Reynolds number and use our Power-law above to estimate drag coefficient:

$$\text{Re}_{\text{Colorado}} = \frac{\rho VL}{\mu} = \frac{(0.001675)(95.3)(8.0)}{3.50\text{E-}7} = 3.65\text{E}6, \quad \text{hence}$$

$$C_D \approx \frac{1.07}{(3.65\text{E}6)^{0.106}} = 0.2157, \quad \therefore \mathbf{F} = 0.2157(0.001675)(95.3)^2(8.0)^2 = \mathbf{210 \text{ lbf}} \quad \text{Ans. (a)}$$

(b) The horsepower required to overcome drag is

$$\text{Power} = FV = (210)(95.3) = 20030 \text{ ft}\cdot\text{lbf/s} \div 550 = \mathbf{36.4 \text{ hp}} \quad \text{Ans. (b)}$$

**5.6** SAE 10 oil at  $20^\circ\text{C}$  flows past an 8-cm-diameter sphere. At flow velocities of 1, 2, and 3 m/s, the measured sphere drag forces are 1.5, 5.3, and 11.2 N, respectively. Estimate the drag force if the same sphere is tested at a velocity of 15 m/s in glycerin at  $20^\circ\text{C}$ .

**Solution:** For SAE 10 oil at  $20^\circ\text{C}$ , take  $\rho \approx 870 \text{ kg/m}^3$  and  $\mu \approx 0.104 \text{ kg/m}\cdot\text{s}$ . Convert the raw drag and velocity data into dimensionless form:

V (m/s):	1	2	3
F (newtons):	1.5	5.3	11.2
$C_D = F/(\rho V^2 D^2)$ :	0.269	0.238	0.224
$\text{Re}_L = \rho VD/\mu$ :	669	1338	2008

Drag coefficient plots versus Reynolds number in a very smooth fashion and is well fit (to  $\pm 1\%$ ) by the power-law formula  $C_D \approx 0.81\text{Re}_L^{-0.17}$ .

The new velocity is  $V = 15 \text{ m/s}$ , and for glycerin at  $20^\circ\text{C}$  (Table A-3), take  $\rho \approx 1260 \text{ kg/m}^3$  and  $\mu \approx 1.49 \text{ kg/m}\cdot\text{s}$ . Then compute the new Reynolds number and use our experimental correlation to estimate the drag coefficient:

$$\text{Re}_{\text{glycerin}} = \frac{\rho VD}{\mu} = \frac{(1260)(15)(0.08)}{1.49} = 1015 \quad (\text{within the range}), \quad \text{hence}$$

$$C_D = 0.81/(1015)^{0.17} \approx 0.250, \quad \text{or: } \mathbf{F}_{\text{glycerin}} = 0.250(1260)(15)^2(0.08)^2 = \mathbf{453 \text{ N}} \quad \text{Ans.}$$

**5.7** A body is dropped on the moon ( $g = 1.62 \text{ m/s}^2$ ) with an initial velocity of 12 m/s. By using option 2 variables, Eq. (5.11), the ground impact occurs at  $t^{**} = 0.34$  and  $S^{**} = 0.84$ . Estimate (a) the initial displacement, (b) the final displacement, and (c) the time of impact.

**Solution:** (a) The initial displacement follows from the “option 2” formula, Eq. (5.12):

$$S^{**} = gS_o/V_o^2 + t^{**} + \frac{1}{2}t^{**2} = 0.84 = \frac{(1.62)S_o}{(12)^2} + 0.34 + \frac{1}{2}(0.34)^2$$

Solve for  $S_o \approx \mathbf{39 \text{ m}}$  Ans. (a)

(b, c) The final time and displacement follow from the given dimensionless results:

$$S^{**} = gS/V_o^2 = 0.84 = (1.62)S/(12)^2, \quad \text{solve for } S_{\text{final}} \approx \mathbf{75 \text{ m}} \quad \text{Ans. (b)}$$

$$t^{**} = gt/V_o = 0.34 = (1.62)t/(12), \quad \text{solve for } t_{\text{impact}} \approx \mathbf{2.52 \text{ s}} \quad \text{Ans. (c)}$$

**5.8** The *Morton number*  $Mo$ , used to correlate bubble-dynamics studies, is a dimensionless combination of acceleration of gravity  $g$ , viscosity  $\mu$ , density  $\rho$ , and surface tension coefficient  $Y$ . If  $Mo$  is proportional to  $g$ , find its form.

**Solution:** The relevant dimensions are  $\{g\} = \{LT^{-2}\}$ ,  $\{\mu\} = \{ML^{-1}T^{-1}\}$ ,  $\{\rho\} = \{ML^{-3}\}$ , and  $\{Y\} = \{MT^{-2}\}$ . To have  $g$  in the numerator, we need the combination:

$$\{Mo\} = \{g\}\{\mu\}^a\{\rho\}^b\{Y\}^c = \left\{\frac{L}{T^2}\right\}\left\{\frac{M}{LT}\right\}^a\left\{\frac{M}{L^3}\right\}^b\left\{\frac{M}{T^2}\right\}^c = M^0L^0T^0$$

Solve for  $a = 4$ ,  $b = -1$ ,  $c = -3$ , or:  $Mo = \frac{g\mu^4}{\rho Y^3}$  Ans.

**5.9** The *acceleration number*,  $Ac$ , sometimes used in compressible-flow theory, is a dimensionless combination of acceleration of gravity  $g$ , viscosity  $\mu$ , density  $\rho$ , and bulk modulus  $B$ . If  $Ac$  is inversely proportional to density, find its form.

**Solution:** The relevant dimensions are  $\{g\} = \{LT^{-2}\}$ ,  $\{\mu\} = \{ML^{-1}T^{-1}\}$ ,  $\{\rho\} = \{ML^{-3}\}$ , and  $\{B\} = \{ML^{-1}T^{-2}\}$ . To have  $\rho$  in the denominator, we need the combination:

$$\{Ac\} = \{\rho^{-1}\}\{g\}^a\{\mu\}^b\{B\}^c = \left\{\frac{L^3}{M}\right\}\left\{\frac{L}{T^2}\right\}^a\left\{\frac{M}{LT}\right\}^b\left\{\frac{M}{LT^2}\right\}^c = M^0L^0T^0$$

Solve for  $a = -2$ ,  $b = -2$ ,  $c = 3$ , or:  $Ac = \frac{B^3}{\rho\mu^2g^2}$  Ans.

5.10 Determine the dimension  $\{MLT\Theta\}$  of the following quantities:

$$(a) \rho u \frac{\partial u}{\partial x} \quad (b) \int_1^2 (p - p_0) dA \quad (c) \rho c_p \frac{\partial^2 T}{\partial x \partial y} \quad (d) \iiint \rho \frac{\partial u}{\partial t} dx dy dz$$

All quantities have their standard meanings; for example,  $\rho$  is density, etc.

**Solution:** Note that  $\{\partial u/\partial x\} = \{U/L\}$ ,  $\{\int p dA\} = \{pA\}$ , etc. The results are:

$$(a) \left\{ \frac{M}{L^2 T^2} \right\}; \quad (b) \left\{ \frac{ML}{T^2} \right\}; \quad (c) \left\{ \frac{M}{L^3 T^2} \right\}; \quad (d) \left\{ \frac{ML}{T^2} \right\} \quad Ans.$$

5.11 For a particle moving in a circle, its centripetal acceleration takes the form  $a = fcn(V, R)$ , where  $V$  is its velocity and  $R$  the radius of its path. By pure dimensional reasoning, rewrite this function in algebraic form.

**Solution:** The “function” of  $V$  and  $R$  must have acceleration units. Thus

$$\{a\} = \{f(V, R)\}, \quad \text{or} \quad a = \text{const } V^c R^d, \quad \text{or:} \quad \left\{ \frac{L}{T^2} \right\} = \left\{ \frac{L}{T} \right\}^c \{L\}^d$$

Solve for  $c = 2$  and  $d = -1$ , or, as expected, it can only be that  $\mathbf{a} = \text{const } \mathbf{V}^2 \mathbf{R}^{-1}$  *Ans.*

5.12 The *Stokes number*,  $St$ , used in particle-dynamics studies, is a dimensionless combination of *five* variables: acceleration of gravity  $g$ , viscosity  $\mu$ , density  $\rho$ , particle velocity  $U$ , and particle diameter  $D$ . (a) If  $St$  is proportional to  $\mu$  and inversely proportional to  $g$ , find its form. (b) Show that  $St$  is actually the quotient of two more traditional dimensionless groups.

**Solution:** (a) The relevant dimensions are  $\{g\} = \{LT^{-2}\}$ ,  $\{\mu\} = \{ML^{-1}T^{-1}\}$ ,  $\{\rho\} = \{ML^{-3}\}$ ,  $\{U\} = \{LT^{-1}\}$ , and  $\{D\} = \{L\}$ . To have  $\mu$  in the numerator and  $g$  in the denominator, we need the combination:

$$\{St\} = \{\mu\} \{g\}^{-1} \{\rho\}^a \{U\}^b \{D\}^c = \left\{ \frac{M}{LT} \right\} \left\{ \frac{T^2}{L} \right\} \left\{ \frac{M}{L^3} \right\}^a \left\{ \frac{L}{T} \right\}^b \{L\}^c = M^0 L^0 T^0$$



$$\text{Solve for } a = -1, b = 1, c = -2, \text{ or: } St = \frac{\mu U}{\rho g D^2} \quad \text{Ans. (a)}$$

$$\text{This has the ratio form: } St = \frac{U^2/(gD)}{\rho U D/\mu} = \frac{\text{Froude number}}{\text{Reynolds number}} \quad \text{Ans. (b)}$$

**5.13** The speed of propagation  $C$  of a capillary wave in deep water is known to be a function only of density  $\rho$ , wavelength  $\lambda$ , and surface tension  $Y$ . Find the proper functional relationship, completing it with a dimensionless constant. For a given density and wavelength, how does the propagation speed change if the surface tension is doubled?

**Solution:** The “function” of  $\rho$ ,  $\lambda$ , and  $Y$  must have velocity units. Thus

$$\{C\} = \{f(\rho, \lambda, Y)\}, \text{ or } C = \text{const } \rho^a \lambda^b Y^c, \text{ or: } \left\{ \frac{L}{T} \right\} = \left\{ \frac{M}{L^3} \right\}^a \{L\}^b \left\{ \frac{M}{T^2} \right\}^c$$

$$\text{Solve for } a = b = -1/2 \text{ and } c = +1/2, \text{ or: } C = \text{const } \sqrt{\frac{Y}{\rho \lambda}} \quad \text{Ans.}$$

Thus, for constant  $\rho$  and  $\lambda$ , if  $Y$  is doubled,  $C$  increases as  $\sqrt{2}$ , or **+41%**. *Ans.*

**5.14** In flow past a flat plate, the boundary layer thickness  $\delta$  varies with distance  $x$ , freestream velocity  $U$ , viscosity  $\mu$ , and density  $\rho$ . Find the dimensionless parameters for this problem and compare with the standard parameters in Table 5.2.

**Solution:** The functional relationship is  $\delta = \text{fcn}(x, U, \mu, \rho)$ , with  $n = 5$  variables and  $j = 3$  primary dimensions (M, L, T). Thus we expect  $n - j = 5 - 3 = 2$  Pi groups:

$$\Pi_1 = \rho^a x^b \mu^c \delta^1 = M^0 L^0 T^0 \quad \text{if } a = 0, b = -1, c = 0: \Pi_1 = \frac{\delta}{x}$$

$$\Pi_2 = \rho^a x^b \mu^c U^1 = M^0 L^0 T^0 \quad \text{if } a = 1, b = 1, c = -1: \Pi_2 = \frac{\rho U x}{\mu}$$

Thus  $\delta/x = \text{fcn}(\rho U x/\mu) = \text{fcn}(\text{Re}_x)$  just as in the theory, Eqs. (7.1a,b). *Ans.*

**5.15** The wall shear stress  $\tau_w$  in a boundary layer is assumed to be a function of stream velocity  $U$ , boundary layer thickness  $\delta$ , local turbulence velocity  $u'$ , density  $\rho$ , and local

pressure gradient  $dp/dx$ . Using  $(\rho, U, \delta)$  as repeating variables, rewrite this relationship as a dimensionless function.

**Solution:** The relevant dimensions are  $\{\tau_w\} = \{ML^{-1}T^{-2}\}$ ,  $\{U\} = \{LT^{-1}\}$ ,  $\{\delta\} = \{L\}$ ,  $\{u'\} = \{LT^{-1}\}$ ,  $\{\rho\} = \{ML^{-3}\}$ , and  $\{dp/dx\} = \{ML^{-2}T^{-2}\}$ . With  $n = 6$  and  $j = 3$ , we expect  $n - j = k = 3$  pi groups:

$$\Pi_1 = \rho^a U^b \delta^c \tau_w = \left\{ \frac{M}{L^3} \right\}^a \left\{ \frac{L}{T} \right\}^b \{L\}^c \left\{ \frac{M}{LT^2} \right\} = M^0 L^0 T^0, \quad \text{solve } a = -1, b = -2, c = 0$$

$$\Pi_2 = \rho^a U^b \delta^c u' = \left\{ \frac{M}{L^3} \right\}^a \left\{ \frac{L}{T} \right\}^b \{L\}^c \left\{ \frac{L}{T} \right\} = M^0 L^0 T^0, \quad \text{solve } a = 0, b = -1, c = 0$$

$$\Pi_3 = \rho^a U^b \delta^c \frac{dp}{dx} = \left\{ \frac{M}{L^3} \right\}^a \left\{ \frac{L}{T} \right\}^b \{L\}^c \left\{ \frac{M}{L^2 T^2} \right\} = M^0 L^0 T^0, \quad \text{solve } a = -1, b = -2, c = 1$$

The final dimensionless function then is given by:

$$\Pi_1 = fcn(\Pi_2, \Pi_3), \quad \text{or: } \frac{\tau_w}{\rho U^2} = fcn\left(\frac{u'}{U}, \frac{dp}{dx} \frac{\delta}{\rho U^2}\right) \quad \text{Ans.}$$

**5.16** Convection heat-transfer data are often reported as a *heat-transfer coefficient*  $h$ , defined by

$$\dot{Q} = hA\Delta T$$

where  $\dot{Q}$  = heat flow, J/s

$A$  = surface area,  $m^2$

$\Delta T$  = temperature difference, K

The dimensionless form of  $h$ , called the *Stanton number*, is a combination of  $h$ , fluid density  $\rho$ , specific heat  $c_p$ , and flow velocity  $V$ . Derive the Stanton number if it is proportional to  $h$ .

**Solution:** If  $\{\dot{Q}\} = \{hA\Delta T\}$ , then  $\left\{ \frac{ML^2}{T^3} \right\} = \{h\} \{L^2\} \{\Theta\}$ , or:  $\{h\} = \left\{ \frac{M}{\Theta T^3} \right\}$

$$\text{Then } \{\text{Stanton No.}\} = \{h^1 \rho^b c_p^c V^d\} = \left\{ \frac{M}{\Theta T^3} \right\} \left\{ \frac{M}{L^3} \right\}^b \left\{ \frac{L^2}{T^2 \Theta} \right\}^c \left\{ \frac{L}{T} \right\}^d = M^0 L^0 T^0 \Theta^0$$

Solve for  $b = -1$ ,  $c = -1$ , and  $d = -1$ .

$$\text{Thus, finally, Stanton Number} = h\rho^{-1}c_p^{-1}V^{-1} = \frac{h}{\rho V c_p} \quad \text{Ans.}$$

**5.17** The pressure drop per unit length  $\Delta p/L$  in a porous, rotating duct (Really! See Ref. 35) depends upon average velocity  $V$ , density  $\rho$ , viscosity  $\mu$ , duct height  $h$ , wall injection velocity  $v_w$ , and rotation rate  $\Omega$ . Using  $(\rho, V, h)$  as repeating variables, rewrite this relationship in dimensionless form.

**Solution:** The relevant dimensions are  $\{\Delta p/L\} = \{ML^{-2}T^{-2}\}$ ,  $\{V\} = \{LT^{-1}\}$ ,  $\{\rho\} = \{ML^{-3}\}$ ,  $\{\mu\} = \{ML^{-1}T^{-1}\}$ ,  $\{h\} = \{L\}$ ,  $\{v_w\} = \{LT^{-1}\}$ , and  $\{\Omega\} = \{T^{-1}\}$ . With  $n = 7$  and  $j = 3$ , we expect  $n - j = k = 4$  pi groups: They are found, as specified, using  $(\rho, V, h)$  as repeating variables:

$$\Pi_1 = \rho^a V^b h^c \frac{\Delta p}{L} = \left\{ \frac{M}{L^3} \right\}^a \left\{ \frac{L}{T} \right\}^b \{L\}^c \left\{ \frac{M}{L^2 T^2} \right\} = M^0 L^0 T^0, \quad \text{solve } a = -1, b = -2, c = 1$$

$$\Pi_2 = \rho^a V^b h^c \mu^{-1} = \left\{ \frac{M}{L^3} \right\}^a \left\{ \frac{L}{T} \right\}^b \{L\}^c \left\{ \frac{M}{LT} \right\}^{-1} = M^0 L^0 T^0, \quad \text{solve } a = 1, b = 1, c = 1$$

$$\Pi_3 = \rho^a V^b h^c \Omega = \left\{ \frac{M}{L^3} \right\}^a \left\{ \frac{L}{T} \right\}^b \{L\}^c \left\{ \frac{1}{T} \right\} = M^0 L^0 T^0, \quad \text{solve } a = 0, b = -1, c = 1$$

$$\Pi_4 = \rho^a V^b h^c v_w = \left\{ \frac{M}{L^3} \right\}^a \left\{ \frac{L}{T} \right\}^b \{L\}^c \left\{ \frac{L}{T} \right\} = M^0 L^0 T^0, \quad \text{solve } a = 0, b = -1, c = 0$$

The final dimensionless function then is given by:

$$\Pi_1 = fcn(\Pi_2, \Pi_3, \Pi_4), \quad \text{or: } \frac{\Delta p}{L} \frac{h}{\rho V^2} = fcn\left(\frac{\rho V h}{\mu}, \frac{\Omega h}{V}, \frac{v_w}{V}\right) \quad \text{Ans.}$$

**5.18** Under laminar conditions, the volume flow  $Q$  through a small triangular-section pore of side length  $b$  and length  $L$  is a function of viscosity  $\mu$ , pressure drop per unit length  $\Delta p/L$ , and  $b$ . Using the pi theorem, rewrite this relation in dimensionless form. How does the volume flow change if the pore size  $b$  is doubled?

**Solution:** Establish the variables and their dimensions:

$$Q = fcn(\Delta p/L, \mu, b)$$

$$\{L^3/T\} \quad \{M/L^2 T^2\} \quad \{M/LT\} \quad \{L\}$$

Then  $n = 4$  and  $j = 3$ , hence we expect  $n - j = 4 - 3 = 1$  Pi group, found as follows:

$$\Pi_1 = (\Delta p/L)^a (\mu)^b (b)^c Q^1 = \{M/L^2 T^2\}^a \{M/LT\}^b \{L\}^c \{L^3/T\}^1 = M^0 L^0 T^0$$

$$M: a + b = 0; \quad L: -2a - b + c + 3 = 0; \quad T: -2a - b - 1 = 0,$$

$$\text{solve } a = -1, b = +1, c = -4$$

$$\Pi_1 = \frac{Q\mu}{(\Delta p/L)b^4} = \text{constant} \quad \text{Ans.}$$

Clearly, if  $b$  is doubled, the flow rate  $Q$  increases by a factor of **16**. *Ans.*

---

**5.19** The period of oscillation  $T$  of a water surface wave is assumed to be a function of density  $\rho$ , wavelength  $\lambda$ , depth  $h$ , gravity  $g$ , and surface tension  $Y$ . Rewrite this relationship in dimensionless form. What results if  $Y$  is negligible?

**Solution:** Establish the variables and their dimensions:

$$T = \text{fcn}(\rho, \lambda, h, g, Y)$$

$$\{T\} \quad \{M/L^3\} \quad \{L\} \quad \{L\} \quad \{L/T^2\} \quad \{M/T^2\}$$

Then  $n = 6$  and  $j = 3$ , hence we expect  $n - j = 6 - 3 = 3$  Pi groups, capable of various arrangements and selected by myself as follows:

$$\text{Typical final result: } T(g/\lambda)^{1/2} = \text{fcn}\left(\frac{h}{\lambda}, \frac{Y}{\rho g \lambda^2}\right) \quad \text{Ans.}$$

$$\text{If } Y \text{ is negligible, } \rho \text{ drops out also, leaving: } T(g/\lambda)^{1/2} = \text{fcn}\left(\frac{h}{\lambda}\right) \quad \text{Ans.}$$


---

**5.20** We can extend Prob. 5.18 to the case of laminar duct flow of a non-newtonian fluid, for which the simplest relation for stress versus strain-rate is the *power-law* approximation:

$$\tau = C \left( \frac{d\theta}{dt} \right)^n$$

This is the analog of Eq. (1.23). The constant  $C$  takes the place of viscosity. If the exponent  $n$  is less than (greater than) unity, the material simulates a pseudoplastic (dilatant) fluid, as illustrated in Fig. 1.7. (a) Using the {MLT} system, determine the dimensions of  $C$ . (b) The analog of Prob. 5.18 for Power-law laminar triangular-duct flow is  $Q = \text{fcn}(C, \Delta p/L, b)$ . Rewrite this function in the form of dimensionless Pi groups.

**Solution:** The shear stress and strain rate have the dimensions  $\{\tau\} = \{ML^{-1}T^{-2}\}$ , and  $\{d\theta/dt\} = \{T^{-1}\}$ .

(a) Using these in the equation enables us to find the dimensions of  $C$ :

$$\left\{\frac{M}{LT^2}\right\} = \{C\} \left\{\frac{1}{T}\right\}^n, \quad \text{hence } \{C\} = \left\{\frac{M}{LT^{2-n}}\right\} \quad \text{Ans. (a)}$$

Now that we know  $\{C\}$ , combine it with  $\{Q\} = \{L^3T^{-1}\}$ ,  $\{\Delta p/L\} = \{ML^{-2}T^{-2}\}$ , and  $\{b\} = \{L\}$ . Note that there are 4 variables and  $j = 3 \{MLT\}$ , hence we expect  $4 - 3 =$  only **one** pi group:

$$\{Q\}^a \left\{\frac{\Delta p}{L}\right\}^b \{L\}^c \{C\} = \left\{\frac{L^3}{T}\right\}^a \left\{\frac{M}{L^2T^2}\right\}^b \{L\}^c \left\{\frac{M}{LT^{2-n}}\right\} = M^0L^0T^0,$$

solve  $a = n, b = -1, c = -3n - 1$

The one and only dimensionless pi group is thus:

$$\Pi_1 = \frac{Q^n C}{(\Delta p/L)b^{3n+1}} = \text{constant} \quad \text{Ans. (b)}$$

**5.21** In Example 5.1 we used the pi theorem to develop Eq. (5.2) from Eq. (5.1). Instead of merely listing the primary dimensions of each variable, some workers list the *powers* of each primary dimension for each variable in an array:

$$\begin{array}{c} F \quad L \quad U \quad \rho \quad \mu \\ M \begin{bmatrix} 1 & 0 & 0 & 1 & 1 \\ L \begin{bmatrix} 1 & 1 & 1 & -3 & -1 \\ T \begin{bmatrix} -2 & 0 & -1 & 0 & -1 \end{bmatrix} \end{array} \end{array}$$

This array of exponents is called the *dimensional matrix* for the given function. Show that the *rank* of this matrix (the size of the largest nonzero determinant) is equal to  $j = n - k$ , the desired reduction between original variables and the pi groups. This is a general property of dimensional matrices, as noted by Buckingham [29].

**Solution:** The **rank** of a matrix is the size of the largest submatrix within which has a *non-zero determinant*. This means that the constants in that submatrix, when considered as coefficients of algebraic equations, are *linearly independent*. Thus we establish the number of *independent* parameters—adding one more forms a dimensionless group. For the example shown, the rank is **three** (note the very first  $3 \times 3$  determinant on the left has a non-zero determinant). Thus “ $j$ ” = 3 for the drag force system of variables.

**5.22** The angular velocity  $\Omega$  of a windmill is a function of windmill diameter  $D$ , wind velocity  $V$ , air density  $\rho$ , windmill height  $H$  as compared to atmospheric boundary layer height  $L$ , and the number of blades  $N$ :  $\Omega = \text{fcn}(D, V, \rho, H/L, N)$ . Viscosity effects are negligible. Rewrite this function in terms of dimensionless Pi groups.

**Solution:** We have  $n = 6$  variables,  $j = 3$  dimensions (M, L, T), thus expect  $n - j = 3$  Pi groups. Since only  $\rho$  has *mass* dimensions, it drops out. After some thought, we realize that  $H/L$  and  $N$  are already dimensionless! The desired dimensionless function becomes:

$$\frac{\Omega D}{V} = \text{fcn}\left(\frac{H}{L}, N\right) \quad \text{Ans.}$$

**5.23** The period  $T$  of vibration of a beam is a function of its length  $L$ , area moment of inertia  $I$ , modulus of elasticity  $E$ , density  $\rho$ , and Poisson's ratio  $\sigma$ . Rewrite this relation in dimensionless form. What further reduction can we make if  $E$  and  $I$  can occur only in the product form  $EI$ ?

**Solution:** Establish the variables and their dimensions:

$$T = \text{fcn}(L, I, E, \rho, \sigma)$$

$$\{T\} \quad \{L\} \{L^4\} \{M/LT^2\} \{M/L^3\} \{\text{none}\}$$

Then  $n = 6$  and  $j = 3$ , hence we expect  $n - j = 6 - 3 = 3$  Pi groups, capable of various arrangements and selected by myself as follows: [Note that  $\sigma$  must be a Pi group.]

$$\text{Typical final result: } \frac{T}{L} \sqrt{\frac{E}{\rho}} = \text{fcn}\left(\frac{L^4}{I}, \sigma\right) \quad \text{Ans.}$$

$$\text{If } E \text{ and } I \text{ can only appear together as } EI, \text{ then } \frac{T}{L^3} \sqrt{\frac{EI}{\rho}} = \text{fcn}(\sigma) \quad \text{Ans.}$$

**5.24** The lift force  $F$  on a missile is a function of its length  $L$ , velocity  $V$ , diameter  $D$ , angle of attack  $\alpha$ , density  $\rho$ , viscosity  $\mu$ , and speed of sound  $a$  of the air. Write out the dimensional matrix of this function and determine its rank. (See Prob. 5.21 for an explanation of this concept.) Rewrite the function in terms of pi groups.

**Solution:** Establish the variables and their dimensions:

$$F = \text{fcn}(L, V, D, \alpha, \rho, \mu, a)$$

$$\{ML/T^2\} \quad \{L\} \{L/T\} \{L\} \{1\} \{M/L^3\} \{M/LT\} \{L/T\}$$

Then  $n = 8$  and  $j = 3$ , hence we expect  $n - j = 8 - 3 = 5$  Pi groups. The matrix is

$$\begin{array}{rcccccccc}
 & \text{F} & \text{L} & \text{V} & \text{D} & \alpha & \rho & \mu & a \\
 \text{M:} & 1 & 0 & 0 & 0 & 0 & 1 & 1 & 0 \\
 \text{L:} & 1 & 1 & 1 & 1 & 0 & -3 & -1 & 1 \\
 \text{T:} & -2 & 0 & -1 & 0 & 0 & 0 & -1 & -1
 \end{array}$$

The rank of this matrix is indeed **three**, hence there are exactly 5 Pi groups, as follows:

$$\text{Typical final result: } \frac{\mathbf{F}}{\rho \mathbf{V}^2 \mathbf{L}^2} = \text{fcn} \left( \alpha, \frac{\rho \mathbf{V} \mathbf{L}}{\mu}, \frac{\mathbf{L}}{\mathbf{D}}, \frac{\mathbf{V}}{\mathbf{a}} \right) \text{ Ans.}$$


---

**5.25** When a viscous fluid is confined between two long concentric cylinders as in Fig. 4.17, the torque per unit length  $T'$  required to turn the inner cylinder at angular velocity  $\Omega$  is a function of  $\Omega$ , cylinder radii  $a$  and  $b$ , and viscosity  $\mu$ . Find the equivalent dimensionless function. What happens to the torque if both  $a$  and  $b$  are doubled?

**Solution:** Establish the variables and their dimensions:

$$\begin{array}{rccccccc}
 T' & = & \text{fcn} & ( & \Omega & , & a & , & b & , & \mu & ) \\
 \{\text{ML/T}^2\} & & & & \{1/\text{T}\} & & \{\text{L}\} & & \{\text{L}\} & & \{\text{M/LT}\} & 
 \end{array}$$

Then  $n = 5$  and  $j = 3$ , hence we expect  $n - j = 5 - 3 = 2$  Pi groups, capable of various arrangements and selected by myself as follows:

$$\text{Typical final result: } \frac{\mathbf{T}'}{\mu \Omega \mathbf{a}^2} = \text{fcn} \left( \frac{\mathbf{b}}{\mathbf{a}} \right) \text{ Ans.}$$

If both  $a$  and  $b$  are doubled, the ratio  $b/a$  remains the same, hence so does  $T'/(\mu\Omega a^2)$ , so the torque  $T'$  increases as  $(2)^2$ , or a factor of **4**. *Ans.*

---

**5.26** A pendulum has an oscillation period  $T$  which is assumed to depend upon its length  $L$ , bob mass  $m$ , angle of swing  $\theta$ , and the acceleration of gravity. A pendulum 1 m long, with a bob mass of 200 g, is tested on earth and found to have a period of 2.04 s when swinging at  $20^\circ$ . (a) What is its period when it swings at  $45^\circ$ ? A similarly constructed pendulum, with  $L = 30$  cm and  $m = 100$  g, is to swing on the moon ( $g = 1.62 \text{ m/s}^2$ ) at  $\theta = 20^\circ$ . (b) What will be its period?

**Solution:** First establish the variables and their dimensions so that we can do the numbers:

$$T = \text{fcn}(L, m, g, \theta)$$

$$\{T\} \quad \{L\} \quad \{M\} \quad \{L/T^2\} \quad \{1\}$$

Then  $n = 5$  and  $j = 3$ , hence we expect  $n - j = 5 - 3 = 2$  Pi groups. They are unique:

$$T\sqrt{\frac{g}{L}} = \text{fcn}(\theta) \quad (\text{mass drops out for dimensional reasons})$$

(a) If we change the angle to  $45^\circ$ , this changes  $\Pi_2$ , hence we lose dynamic similarity and do not know the new period. More testing is required. *Ans.* (a)

(b) If we swing the pendulum on the moon at the same  $20^\circ$ , we may use similarity:

$$T_1 \left( \frac{g_1}{L_1} \right)^{1/2} = (2.04 \text{ s}) \left( \frac{9.81 \text{ m/s}^2}{1.0 \text{ m}} \right)^{1/2} = 6.39 = T_2 \left( \frac{1.62 \text{ m/s}^2}{0.3 \text{ m}} \right)^{1/2},$$

$$\text{or: } T_2 = 2.75 \text{ s} \quad \text{Ans. (b)}$$

**5.27** In studying sand transport by ocean waves, A. Shields in 1936 postulated that the bottom shear stress  $\tau$  required to move particles depends upon gravity  $g$ , particle size  $d$  and density  $\rho_p$ , and water density  $\rho$  and viscosity  $\mu$ . Rewrite this in terms of dimensionless groups (which led to the *Shields Diagram* in 1936).

**Solution:** There are six variables ( $\tau, g, d, \rho_p, \rho, \mu$ ) and three dimensions (M, L, T), hence we expect  $n - j = 6 - 3 = 3$  Pi groups. The author used ( $\rho, g, d$ ) as repeating variables:

$$\frac{\tau}{\rho g d} = \text{fcn} \left( \frac{\rho g^{1/2} d^{3/2}}{\mu}, \frac{\rho_p}{\rho} \right) \quad \text{Ans.}$$

The shear parameter used by Shields himself was based on *net weight*:  $\tau/[(\rho_p - \rho)gd]$ .

**5.28** A simply supported beam of diameter  $D$ , length  $L$ , and modulus of elasticity  $E$  is subjected to a fluid crossflow of velocity  $V$ , density  $\rho$ , and viscosity  $\mu$ . Its center deflection  $\delta$  is assumed to be a function of all these variables. (a) Rewrite this proposed function in dimensionless form. (b) Suppose it is known that  $\delta$  is independent of  $\mu$ , inversely proportional to  $E$ , and dependent only upon  $\rho V^2$ , not  $\rho$  and  $V$  separately. Simplify the dimensionless function accordingly.



**Solution:** Establish the variables and their dimensions:

$$\delta = \text{fcn}(\rho, D, L, E, V, \mu)$$

$$\{L\} \quad \{M/L^3\} \quad \{L\} \quad \{L\} \quad \{M/LT^2\} \quad \{L/T\} \quad \{M/LT\}$$

Then  $n = 7$  and  $j = 3$ , hence we expect  $n - j = 7 - 3 = 4$  Pi groups, capable of various arrangements and selected by myself, as follows (a):

$$\text{Well-posed final result: } \frac{\delta}{L} = \text{fcn}\left(\frac{L}{D}, \frac{\rho VD}{\mu}, \frac{E}{\rho V^2}\right) \quad \text{Ans. (a)}$$

(b) If  $\mu$  is unimportant, then the Reynolds number ( $\rho VD/\mu$ ) drops out, and we have already cleverly combined  $E$  with  $\rho V^2$ , which we can now slip out upside down:

$$\text{If } \mu \text{ drops out and } \delta \propto \frac{1}{E}, \text{ then } \frac{\delta}{L} = \frac{\rho V^2}{E} \text{fcn}\left(\frac{L}{D}\right),$$

$$\text{or: } \frac{\delta E}{\rho V^2 L} = \text{fcn}\left(\frac{L}{D}\right) \quad \text{Ans. (b)}$$

**5.29** When fluid in a pipe is accelerated linearly from rest, it begins as laminar flow and then undergoes transition to turbulence at a time  $t_{tr}$  which depends upon the pipe diameter  $D$ , fluid acceleration  $a$ , density  $\rho$ , and viscosity  $\mu$ . Arrange this into a dimensionless relation between  $t_{tr}$  and  $D$ .

**Solution:** Establish the variables and their dimensions:

$$t_{tr} = \text{fcn}(\rho, D, a, \mu)$$

$$\{T\} \quad \{M/L^3\} \quad \{L\} \quad \{L/T^2\} \quad \{M/LT\}$$

Then  $n = 5$  and  $j = 3$ , hence we expect  $n - j = 5 - 3 = 2$  Pi groups, capable of various arrangements and selected by myself, as required, to isolate  $t_{tr}$  versus  $D$ :

$$t_{tr} \left(\frac{\rho a^2}{\mu}\right)^{1/3} = \text{fcn}\left[D \left(\frac{\rho^2 a}{\mu^2}\right)^{1/3}\right] \quad \text{Ans.}$$

**5.30** The wall shear stress  $\tau_w$  for flow in a narrow annular gap between a fixed and a rotating cylinder is a function of density  $\rho$ , viscosity  $\mu$ , angular velocity  $\Omega$ , outer radius  $R$ , and gap width  $\Delta r$ . Using  $(\rho, \Omega, R)$  as repeating variables, rewrite this relation in dimensionless form.

**Solution:** The relevant dimensions are  $\{\tau_w\} = \{ML^{-1}T^{-2}\}$ ,  $\{\rho\} = \{ML^{-3}\}$ ,  $\{\mu\} = \{ML^{-1}T^{-1}\}$ ,  $\{\Omega\} = \{T^{-1}\}$ ,  $\{R\} = \{L\}$ , and  $\{\Delta r\} = \{L\}$ . With  $n = 6$  and  $j = 3$ , we expect  $n - j = k = 3$  pi groups. They are found, as specified, using  $(\rho, \Omega, R)$  as repeating variables:

$$\Pi_1 = \rho^a \Omega^b R^c \tau_w = \left\{ \frac{M}{L^3} \right\}^a \left\{ \frac{1}{T} \right\}^b \{L\}^c \left\{ \frac{M}{LT^2} \right\} = M^0 L^0 T^0, \quad \text{solve } a = -1, b = -2, c = -2$$

$$\Pi_2 = \rho^a \Omega^b R^c \mu^{-1} = \left\{ \frac{M}{L^3} \right\}^a \left\{ \frac{1}{T} \right\}^b \{L\}^c \left\{ \frac{M}{LT} \right\}^{-1} = M^0 L^0 T^0, \quad \text{solve } a = 1, b = 1, c = 2$$

$$\Pi_3 = \rho^a \Omega^b R^c \Delta r = \left\{ \frac{M}{L^3} \right\}^a \left\{ \frac{1}{T} \right\}^b \{L\}^c \{L\} = M^0 L^0 T^0, \quad \text{solve } a = 0, b = 0, c = -1$$

The final dimensionless function has the form:

$$\Pi_1 = fcn(\Pi_2, \Pi_3), \quad \text{or: } \frac{\tau_{wall}}{\rho \Omega^2 R^2} = fcn\left(\frac{\rho \Omega R^2}{\mu}, \frac{\Delta r}{R}\right) \quad \text{Ans.}$$

**5.31** The heat-transfer rate per unit area  $q$  to a body from a fluid in natural or gravitational convection is a function of the temperature difference  $\Delta T$ , gravity  $g$ , body length  $L$ , and three fluid properties: kinematic viscosity  $\nu$ , conductivity  $k$ , and thermal expansion coefficient  $\beta$ . Rewrite in dimensionless form if it is known that  $g$  and  $\beta$  appear only as the product  $g\beta$ .

**Solution:** Establish the variables and their dimensions:

$$q = fcn(\Delta T, g, L, \nu, \beta, k)$$

$$\{M/T^3\} \quad \{\Theta\} \quad \{L/T^2\} \quad \{L\} \quad \{L^2/T\} \quad \{1/\Theta\} \quad \{ML/\Theta T^3\}$$

Then  $n = 7$  and  $j = 4$ , hence we expect  $n - j = 7 - 4 = 3$  Pi groups, capable of various arrangements and selected by myself, as follows:

$$\text{If } \beta \text{ and } \Delta T \text{ kept separate, then } \frac{qL}{k\Delta T} = fcn\left(\beta\Delta T, \frac{gL^3}{\nu^2}\right)$$

If, in fact,  $\beta$  and  $\Delta T$  must appear together, then  $\Pi_2$  and  $\Pi_3$  above combine and we get

$$\frac{qL}{k\Delta T} = fcn\left(\frac{\beta\Delta T g L^3}{\nu^2}\right) \quad \text{Ans.}$$

Nusselt No.    Grashof Number

**5.32** A *weir* is an obstruction in a channel flow which can be calibrated to measure the flow rate, as in Fig. P5.32. The volume flow  $Q$  varies with gravity  $g$ , weir width  $b$  into the paper, and upstream water height  $H$  above the weir crest. If it is known that  $Q$  is proportional to  $b$ , use the pi theorem to find a unique functional relationship  $Q(g, b, H)$ .

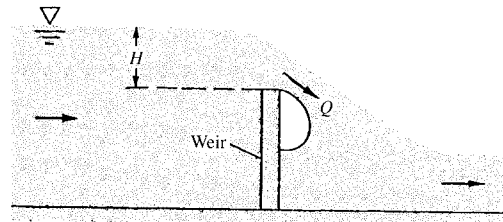


Fig. P5.32

**Solution:** Establish the variables and their dimensions:

$$Q = \text{fcn}(g, b, H)$$

$$\{L^3/T\} \quad \{L/T^2\} \quad \{L\} \quad \{L\}$$

Then  $n = 4$  and  $j = 2$ , hence we expect  $n - j = 4 - 2 = 2$  Pi groups, capable of various arrangements and selected by myself, as follows:

$$\frac{Q}{g^{1/2}H^{5/2}} = \text{fcn}\left(\frac{b}{H}\right); \quad \text{but if } Q \propto b, \text{ then we reduce to } \frac{Q}{bg^{1/2}H^{3/2}} = \text{constant} \quad \text{Ans.}$$

**5.33** A spar buoy (see Prob. 2.113) has a period  $T$  of vertical (heave) oscillation which depends upon the waterline cross-sectional area  $A$ , buoy mass  $m$ , and fluid specific weight  $\gamma$ . How does the period change due to doubling of (a) the mass and (b) the area? Instrument buoys should have long periods to avoid wave resonance. Sketch a possible long-period buoy design.

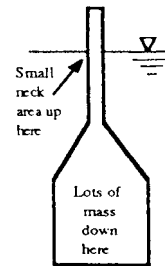


Fig. P5.33

**Solution:** Establish the variables and their dimensions:

$$T = \text{fcn}(A, m, \gamma)$$

$$\{T\} \quad \{L^2\} \quad \{M\} \quad \{M/L^2T^2\}$$

Then  $n = 4$  and  $j = 3$ , hence we expect  $n - j = 4 - 3 = 1$  single Pi group, as follows:

$$T\sqrt{\frac{A\gamma}{m}} = \text{dimensionless constant} \quad \text{Ans.}$$

Since we can't do anything about  $\gamma$ , the specific weight of water, we *can* increase period  $T$  by increasing buoy mass  $m$  and decreasing waterline area  $A$ . See the illustrative long-period buoy in Figure P5.33.

**5.34** To good approximation, the thermal conductivity  $k$  of a gas (see Ref. 8 of Chap. 1) depends only on the density  $\rho$ , mean free path  $\ell$ , gas constant  $R$ , and absolute temperature  $T$ . For air at 20°C and 1 atm,  $k \approx 0.026$  W/m·K and  $\ell \approx 6.5E-8$  m. Use this information to determine  $k$  for hydrogen at 20°C and 1 atm if  $\ell \approx 1.2E-7$  m.

**Solution:** First establish the variables and their dimensions and then form a pi group:

$$k = \text{fcn}(\rho, \ell, R, T)$$

$$\{ML/\Theta T^3\} \quad \{M/L^3\} \quad \{L\} \quad \{L^2/T^2\Theta\} \quad \{\Theta\}$$

Thus  $n = 5$  and  $j = 4$ , and we expect  $n - j = 5 - 4 = 1$  single pi group, and the result is

$$k/(\rho R^{3/2} T^{1/2} \ell) = \text{a dimensionless constant} = \Pi_1$$

The value of  $\Pi_1$  is found from the air data, where  $\rho = 1.205$  kg/m<sup>3</sup> and  $R = 287$  m<sup>2</sup>/s<sup>2</sup>·K:

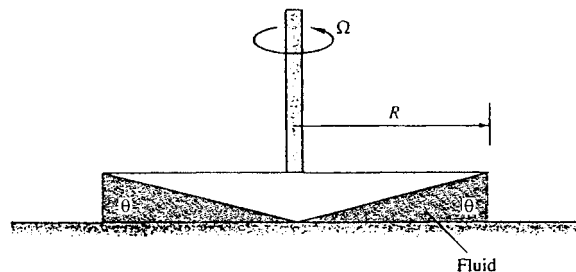
$$\Pi_{1,air} = \frac{0.026}{(1.205)(287)^{3/2}(293)(6.5E-8)} = 3.99 = \Pi_{1,hydrogen}$$

For hydrogen at 20°C and 1 atm, calculate  $\rho = 0.0839$  kg/m<sup>3</sup> with  $R = 4124$  m<sup>2</sup>/s<sup>2</sup>·K. Then

$$\Pi_1 = 3.99 = \frac{k_{hydrogen}}{(0.0839)(4124)^{3/2}(293)^{1/2}(1.2E-7)}, \quad \text{solve for } k_{hydrogen} = \mathbf{0.182} \frac{\mathbf{W}}{\mathbf{m \cdot K}} \quad \text{Ans.}$$

This is slightly larger than the accepted value for hydrogen of  $k \approx 0.178$  W/m·K.

**5.35** The torque  $M$  required to turn the cone-plate viscometer in Fig. P5.35 depends upon the radius  $R$ , rotation rate  $\Omega$ , fluid viscosity  $\mu$ , and cone angle  $\theta$ . Rewrite this relation in dimensionless form. How does the relation simplify if it is known that  $M$  is proportional to  $\theta$ ?



**Fig. P5.35**

**Solution:** Establish the variables and their dimensions:

$$\begin{array}{ccccccc} \mathbf{M} & = \text{fcn} & ( & \mathbf{R} & , & \boldsymbol{\Omega} & , & \boldsymbol{\mu} & , & \boldsymbol{\theta} & ) \\ \{ \mathbf{ML}^2/\mathbf{T}^2 \} & & & \{ \mathbf{L} \} & & \{ 1/\mathbf{T} \} & & \{ \mathbf{M}/\mathbf{LT} \} & & \{ 1 \} & \end{array}$$

Then  $n = 5$  and  $j = 3$ , hence we expect  $n - j = 5 - 3 = 2$  Pi groups, capable of only one reasonable arrangement, as follows:

$$\frac{\mathbf{M}}{\boldsymbol{\mu}\boldsymbol{\Omega}\mathbf{R}^3} = \text{fcn}(\boldsymbol{\theta}); \quad \text{if } \mathbf{M} \propto \boldsymbol{\theta}, \quad \text{then } \frac{\mathbf{M}}{\boldsymbol{\mu}\boldsymbol{\Omega}\boldsymbol{\theta}\mathbf{R}^3} = \text{constant} \quad \text{Ans.}$$

See Prob. 1.56 of this Manual, for an analytical solution.

**5.36** The rate of heat loss,  $Q_{\text{loss}}$  through a window is a function of the temperature difference  $\Delta T$ , the surface area  $A$ , and the  $R$  resistance value of the window (in units of  $\text{ft}^2 \cdot \text{hr} \cdot ^\circ\text{F}/\text{Btu}$ ):  $Q_{\text{loss}} = \text{fcn}(\Delta T, A, R)$ . (a) Rewrite in dimensionless form. (b) If the temperature difference doubles, how does the heat loss change?

**Solution:** First figure out the dimensions of  $R$ :  $\{R\} = \{T^3\Theta/M\}$ . Then note that  $n = 4$  variables and  $j = 3$  dimensions, hence we expect only  $4 - 3 = \text{one}$  Pi group, and it is:

$$\Pi_1 = \frac{Q_{\text{loss}}R}{A\Delta T} = \text{Const}, \quad \text{or:} \quad Q_{\text{loss}} = \text{Const} \frac{A\Delta T}{R} \quad \text{Ans. (a)}$$

(b) Clearly (to me),  $Q \propto \Delta T$ : **if  $\Delta t$  doubles,  $Q_{\text{loss}}$  also doubles.** Ans. (b)

**5.37** The pressure difference  $\Delta p$  across an explosion or blast wave is a function of the distance  $r$  from the blast center, time  $t$ , speed of sound  $a$  of the medium, and total energy  $E$  in the blast. Rewrite this relation in dimensionless form (see Ref. 18, chap. 4, for further details of blast-wave scaling). How does  $\Delta p$  change if  $E$  is doubled?

**Solution:** Establish the variables and their dimensions:

$$\begin{array}{ccccccc} \Delta p & = \text{fcn} & ( & r & , & t & , & a & , & E & ) \\ \{ \mathbf{M}/\mathbf{LT}^2 \} & & & \{ \mathbf{L} \} & & \{ \mathbf{T} \} & & \{ \mathbf{L}/\mathbf{T} \} & & \{ \mathbf{ML}^2/\mathbf{T}^2 \} & \end{array}$$

Then  $n = 5$  and  $j = 3$ , hence we expect  $n - j = 5 - 3 = 2$  Pi groups, capable of various arrangements and selected by me, as follows:

$$\frac{\Delta p r^3}{E} = \text{fcn} \left( \frac{at}{r} \right) \quad \text{Ans.}$$

If  $E$  is doubled with  $(r, t, a)$  remaining the same, then  $\Delta p$  is also doubled. Ans.

**5.38** The size  $d$  of droplets produced by a liquid spray nozzle is thought to depend upon the nozzle diameter  $D$ , jet velocity  $U$ , and the properties of the liquid  $\rho$ ,  $\mu$ , and  $Y$ . Rewrite this relation in dimensionless form.

**Solution:** Establish the variables and their dimensions:

$$d = \text{fcn}( D, U, \rho, \mu, Y )$$

$$\{L\} \quad \{L\} \quad \{L/T\} \quad \{M/L^3\} \quad \{M/LT\} \quad \{M/T^2\}$$

Then  $n = 6$  and  $j = 3$ , hence we expect  $n - j = 6 - 3 = 3$  Pi groups, capable of various arrangements and selected by me, as follows:

$$\text{Typical final result: } \frac{d}{D} = \text{fcn} \left( \frac{\rho U D}{\mu}, \frac{\rho U^2 D}{Y} \right) \text{ Ans.}$$

**5.39** In turbulent flow past a flat surface, the velocity  $u$  near the wall varies approximately logarithmically with distance  $y$  from the wall and also depends upon viscosity  $\mu$ , density  $\rho$ , and wall shear stress  $\tau_w$ . For a certain airflow at 20°C and 1 atm,  $\tau_w = 0.8$  Pa and  $u = 15$  m/s at  $y = 3.6$  mm. Use this information to estimate the velocity  $u$  at  $y = 6$  mm.

**Solution:** Establish the variables and their dimensions:

$$u = \text{fcn}( y, \rho, \mu, \tau_w )$$

$$\{L/T\} \quad \{L\} \quad \{M/L^3\} \quad \{M/LT\} \quad \{M/LT^2\}$$

Then  $n = 5$  and  $j = 3$ , hence we expect  $n - j = 5 - 3 = 2$  Pi groups, capable of various arrangements and selected by me to form the traditional “u” versus “y,” as follows:

$$\text{Ideal non-dimensionalization: } \frac{u}{\sqrt{(\tau_w/\rho)}} \approx \text{const} \ln \left( \frac{y\sqrt{(\tau_w\rho)}}{\mu} \right)$$

The logarithmic relation is assumed in the problem, and the “constant” can be evaluated from the given data. For air at 20°C, take  $\rho = 1.20$  kg/m<sup>3</sup>, and  $\mu = 1.8E-5$  kg/m·s. Then

$$\frac{15}{\sqrt{(0.8/1.20)}} \approx C \ln \left[ \frac{(0.0036)(0.8)^{1/2}(1.20)^{1/2}}{1.8E-5} \right], \quad \text{or: } C \approx 3.48 \quad \text{for this data}$$

Further out, at  $y = 6$  mm, we assume that the same logarithmic relation holds. Thus

$$\text{At } y = 6 \text{ mm: } \frac{u}{\sqrt{(0.8/1.20)}} \approx 3.48 \ln \left[ \frac{(0.006)(0.8)^{1/2}(1.2)^{1/2}}{1.8E-5} \right], \text{ or } u \approx 16.4 \frac{\text{m}}{\text{s}} \text{ Ans.}$$


---

**5.40** Reconsider the slanted-plate surface tension problem (see Fig. C1.1) as an exercise in dimensional analysis. Let the capillary rise  $h$  vary only with fluid properties, bottom width, gravity, and the two angles in Fig. C1.1. That is,  $h = \text{fcn}(\rho, Y, g, L, \alpha, \theta)$ . (a) Rewrite this function in terms of dimensionless parameters. (b) Verify that the exact solution from Prob. C1.1 is consistent with your result to part (a).

**Solution:** There are  $n = 7$  variables and three dimensions (M, L, T), hence we expect  $n - j = 7 - 3 = 4$  Pi groups. (a) The author used  $(\rho, g, L)$  as repeating variables to yield

$$\frac{h}{L} = \text{fcn} \left( \frac{\rho g L^2}{Y}, \theta, \alpha \right) \text{ Ans. (a)}$$

(b) The exact solution to Prob. C1.1 is complicated, but is exactly of the form of (a):

$$\frac{h}{L} \left( 1 - \frac{h}{L} \tan \alpha \right) \left( \frac{\rho g L^2}{Y} \right) = 2 \cos(\theta - \alpha) \text{ Ans. (b)}$$


---

**5.41** A certain axial-flow turbine has an output torque  $M$  which is proportional to the volume flow rate  $Q$  and also depends upon the density  $\rho$ , rotor diameter  $D$ , and rotation rate  $\Omega$ . How does the torque change due to a doubling of (a)  $D$  and (b)  $\Omega$ ?

**Solution:** List the variables and their dimensions, one of which can be  $M/Q$ , since  $M$  is stated to be proportional to  $Q$ :

$$\begin{array}{cccc} M/Q & = & \text{fcn} & ( D , \rho , \Omega ) \\ \{M/LT\} & & & \{L\} \{M/L^3\} \{1/T\} \end{array}$$

Then  $n = 4$  and  $j = 3$ , hence we expect  $n - j = 4 - 3 = 1$  single Pi group:

$$\frac{M/Q}{\rho \Omega D^2} = \text{dimensionless constant}$$

(a) If turbine diameter  $D$  is doubled, the torque  $M$  increases by a factor of **4**. *Ans. (a)*

(b) If turbine speed  $\Omega$  is doubled, the torque  $M$  increases by a factor of **2**. *Ans. (b)*

---

**5.42** Non-dimensionalize the thermal energy partial differential equation (4.75) and its boundary conditions (4.62), (4.63), and (4.70) by defining dimensionless temperature  $T^* = T/T_o$ , where  $T_o$  is the fluid inlet temperature, assumed constant. Use other dimensionless variables as needed from Eqs. (5.23). Isolate all dimensionless parameters which you find, and relate them to the list given in Table 5.2.

**Solution:** Recall the previously defined variables in addition to  $T^*$  :

$$u^* = \frac{u}{U}; \quad x^* = \frac{x}{L}; \quad t^* = \frac{Ut}{L}; \quad \text{similarly, } v^* \text{ or } w^* = \frac{v \text{ or } w}{U}; \quad y^* \text{ or } z^* = \frac{y \text{ or } z}{L}$$

Then the dimensionless versions of Eqs. (4.75, 62, 63, 70) result as follows:

$$(4.75): \quad \frac{dT^*}{dt^*} = \underbrace{\left( \frac{k}{\rho c_p UL} \right)}_{\text{1/Peclet Number}} \nabla^{*2} T^* + \underbrace{\left( \frac{\mu U}{\rho c_p T_o L} \right)}_{\text{Eckert Number divided by Reynolds Number}} \Phi^*$$

$$(4.62): \quad T^*|_{\text{wall}} = T_w/T_o \quad (4.63): \quad T^*|_{\text{inlet,exit}} = \text{known function}$$

$$(4.70): \quad \left. \frac{\partial T^*}{\partial z^*} \right|_{\text{liquid}} = (k_{\text{gas}}/k_{\text{liquid}}) \left. \frac{\partial T^*}{\partial z^*} \right|_{\text{gas}} \quad \text{at a gas-liquid interface} \quad \text{Ans.}$$

**5.43** The differential equation of salt conservation for flowing seawater is

$$\frac{\partial S}{\partial t} + u \frac{\partial S}{\partial x} + v \frac{\partial S}{\partial y} + w \frac{\partial S}{\partial z} = \kappa \left( \frac{\partial^2 S}{\partial x^2} + \frac{\partial^2 S}{\partial y^2} + \frac{\partial^2 S}{\partial z^2} \right)$$

where  $\kappa$  is a (constant) coefficient of diffusion, with typical units of square meters per second, and  $S$  is the salinity in parts per thousand. Nondimensionalize this equation and discuss any parameters which appear.

**Solution:** Recall the previously defined variables from Eq. (5.23):

$$u^* = \frac{u}{U}; \quad x^* = \frac{x}{L}; \quad t^* = \frac{Ut}{L}; \quad \text{similarly, } v^* \text{ or } w^* = \frac{v \text{ or } w}{U}; \quad y^* \text{ or } z^* = \frac{y \text{ or } z}{L}$$

Substitute into this salt-conservation relation, noting that  $S$  itself is dimensionless:

$$\frac{\partial S}{\partial t^*} + u^* \frac{\partial S}{\partial x^*} + v^* \frac{\partial S}{\partial y^*} + w^* \frac{\partial S}{\partial z^*} = \left( \frac{\kappa}{UL} \right) \nabla^{*2} S$$

There is only one parameter:  $\kappa/UL$ , or  $UL/\kappa =$  “diffusion” Reynolds number (Peclet No.).



**5.44** The differential energy equation for incompressible two-dimensional flow through a “Darcy-type” porous medium is approximately

$$\rho c_p \frac{\sigma}{\mu} \frac{\partial p}{\partial x} \frac{\partial T}{\partial x} + \rho c_p \frac{\sigma}{\mu} \frac{\partial p}{\partial y} \frac{\partial T}{\partial y} + k \frac{\partial^2 T}{\partial y^2} = 0$$

where  $\sigma$  is the *permeability* of the porous medium. All other symbols have their usual meanings. (a) What are the appropriate dimensions for  $\sigma$ ? (b) Nondimensionalize this equation, using  $(L, U, \rho, T_0)$  as scaling constants, and discuss any dimensionless parameters which arise.

**Solution:** (a) The only way to establish  $\{\sigma\}$  is by comparing two terms in the PDE:

$$\left\{ \rho c_p \frac{\sigma}{\mu} \frac{\partial p}{\partial x} \frac{\partial T}{\partial x} \right\} = \left\{ k \frac{\partial^2 T}{\partial x^2} \right\}, \quad \text{or:} \quad \left\{ \frac{\text{M}}{\text{L}^3 \text{T}^3} \right\} \{\sigma\} \stackrel{?}{=} \left\{ \frac{\text{M}}{\text{LT}^3} \right\},$$

$$\text{Thus } \{\sigma\} = \{\text{L}^2\} \quad \text{Ans. (a)}$$

(b) Define dimensionless variables using the stated list of  $(L, U, \rho, T_0)$  for scaling:

$$x^* = \frac{x}{L}; \quad y^* = \frac{y}{L}; \quad p^* = \frac{p}{\rho U^2}; \quad T^* = \frac{T}{T_0}$$

Substitution into the basic PDE above yields only a *single* dimensionless parameter:

$$\zeta \left( \frac{\partial p^*}{\partial x^*} \frac{\partial T^*}{\partial x^*} + \frac{\partial p^*}{\partial y^*} \frac{\partial T^*}{\partial y^*} \right) + \frac{\partial^2 T^*}{\partial y^{*2}} = 0, \quad \text{where } \zeta = \frac{\rho^2 c_p U^2 \sigma}{\mu k} \quad \text{Ans. (b)}$$

I don't know the name of this parameter. It is related to the “Darcy-Rayleigh” number.

**5.45** A model differential equation, for chemical reaction dynamics in a plug reactor, is as follows:

$$u \frac{\partial C}{\partial x} = \mathcal{D} \frac{\partial^2 C}{\partial x^2} - kC - \frac{\partial C}{\partial t}$$

where  $u$  is the velocity,  $\mathcal{D}$  is a diffusion coefficient,  $k$  is a reaction rate,  $x$  is distance along the reactor, and  $C$  is the (dimensionless) concentration of a given chemical in the reactor.

(a) Determine the appropriate dimensions of  $\mathcal{D}$  and  $k$ . (b) Using a characteristic length scale  $L$  and average velocity  $V$  as parameters, rewrite this equation in dimensionless form and comment on any Pi groups appearing.

**Solution:** (a) Since all terms in the equation contain  $C$ , we establish the dimensions of  $k$  and  $\mathcal{D}$  by comparing  $\{k\}$  and  $\{\mathcal{D}\partial^2/\partial x^2\}$  to  $\{u\partial/\partial x\}$ :

$$\{k\} = \{\mathcal{D}\} \left\{ \frac{\partial^2}{\partial x^2} \right\} = \{\mathcal{D}\} \left\{ \frac{1}{L^2} \right\} = \{u\} \left\{ \frac{\partial}{\partial x} \right\} = \left\{ \frac{L}{T} \right\} \left\{ \frac{1}{L} \right\},$$

$$\text{hence } \{k\} = \left\{ \frac{1}{T} \right\} \text{ and } \{\mathcal{D}\} = \left\{ \frac{L^2}{T} \right\} \quad \text{Ans. (a)}$$

(b) To non-dimensionalize the equation, define  $u^* = u/V$ ,  $t^* = Vt/L$ , and  $x^* = x/L$  and substitute into the basic partial differential equation. The dimensionless result is

$$u^* \frac{\partial C}{\partial x^*} = \left( \frac{\mathcal{D}}{VL} \right) \frac{\partial^2 C}{\partial x^{*2}} - \left( \frac{kL}{V} \right) C - \frac{\partial C}{\partial t^*}, \text{ where } \frac{VL}{\mathcal{D}} = \text{mass-transfer Peclet number} \quad \text{Ans. (b)}$$

**5.46** The differential equation for compressible inviscid flow of a gas in the  $xy$  plane is

$$\frac{\partial^2 \phi}{\partial t^2} + \frac{\partial}{\partial t}(u^2 + v^2) + (u^2 - a^2) \frac{\partial^2 \phi}{\partial x^2} + (v^2 - a^2) \frac{\partial^2 \phi}{\partial y^2} + 2uv \frac{\partial^2 \phi}{\partial x \partial y} = 0$$

where  $\phi$  is the velocity potential and  $a$  is the (variable) speed of sound of the gas. Nondimensionalize this relation, using a reference length  $L$  and the inlet speed of sound  $a_0$  as parameters for defining dimensionless variables.

**Solution:** The appropriate dimensionless variables are  $u^* = u/a_0$ ,  $t^* = a_0 t/L$ ,  $x^* = x/L$ ,  $y^* = y/L$ , and  $\phi^* = \phi/(a_0 L)$ . Substitution into the PDE for  $\phi$  as above yields

$$\frac{\partial^2 \phi^*}{\partial t^{*2}} + \frac{\partial}{\partial t^*}(u^{*2} + v^{*2}) + (u^{*2} - a^{*2}) \frac{\partial^2 \phi^*}{\partial x^{*2}} + (v^{*2} - a^{*2}) \frac{\partial^2 \phi^*}{\partial y^{*2}} + 2u^*v^* \frac{\partial^2 \phi^*}{\partial x^* \partial y^*} = 0 \quad \text{Ans.}$$

The PDE comes clean and there are no dimensionless parameters. *Ans.*

**5.47** The differential equation for small-amplitude vibrations  $y(x, t)$  of a simple beam is given by

$$\rho A \frac{\partial^2 y}{\partial t^2} + EI \frac{\partial^4 y}{\partial x^4} = 0$$

where  $\rho$  = beam material density  
 $A$  = cross-sectional area  
 $I$  = area moment of inertia  
 $E$  = Young's modulus

Use only the quantities  $\rho$ ,  $E$ , and  $A$  to nondimensionalize  $y$ ,  $x$ , and  $t$ , and rewrite the differential equation in dimensionless form. Do any parameters remain? Could they be removed by further manipulation of the variables?

**Solution:** The appropriate dimensionless variables are

$$y^* = \frac{y}{\sqrt{A}}; \quad t^* = t \sqrt{\frac{E}{\rho A}}; \quad x^* = \frac{x}{\sqrt{A}}$$

Substitution into the PDE above yields a dimensionless equation with *one* parameter:

$$\frac{\partial^2 y^*}{\partial t^{*2}} + \left( \frac{I}{A^2} \right) \frac{\partial^4 y^*}{\partial x^{*4}} = 0; \quad \text{One geometric parameter: } \frac{I}{A^2} \quad \text{Ans.}$$

We could *remove*  $(I/A^2)$  completely by redefining  $x^* = x/I^{1/4}$ . *Ans.*

**5.48** A smooth steel ( $SG = 7.86$ ) sphere is immersed in a stream of ethanol at  $20^\circ\text{C}$  moving at  $1.5$  m/s. Estimate its drag in N from Fig. 5.3a. What stream velocity would quadruple its drag? Take  $D = 2.5$  cm.

**Solution:** For ethanol at  $20^\circ\text{C}$ , take  $\rho \approx 789$  kg/m<sup>3</sup> and  $\mu \approx 0.0012$  kg/m·s. Then

$$\text{Re}_D = \frac{\rho U D}{\mu} = \frac{789(1.5)(0.025)}{0.0012} \approx 24700; \quad \text{Read Fig. 5.3(a): } C_{D,\text{sphere}} \approx 0.4$$

$$\begin{aligned} \text{Compute drag } F &= C_D \left( \frac{1}{2} \right) \rho U^2 \frac{\pi}{4} D^2 = (0.4) \left( \frac{1}{2} \right) (789)(1.5)^2 \left( \frac{\pi}{4} \right) (0.025)^2 \\ &\approx \mathbf{0.17 \text{ N}} \quad \text{Ans.} \end{aligned}$$

Since  $C_D \approx$  constant in this range of  $\text{Re}_D$ , **doubling  $U$  quadruples the drag.** *Ans.*

**5.49** The sphere in Prob. 5.48 is dropped in gasoline at  $20^\circ\text{C}$ . Ignoring its acceleration phase, what will its terminal (constant) fall velocity be, from Fig. 5.3a?

**Solution:** For gasoline at  $20^\circ\text{C}$ , take  $\rho \approx 680$  kg/m<sup>3</sup> and  $\mu \approx 2.92\text{E}-4$  kg/m·s. For steel take  $\rho \approx 7800$  kg/m<sup>3</sup>. Then, in “terminal” velocity, the net weight equals the drag force:

$$\text{Net weight} = (\rho_{\text{steel}} - \rho_{\text{gasoline}}) g \frac{\pi}{6} D^3 = \text{Drag force,}$$

$$\text{or: } (7800 - 680)(9.81) \frac{\pi}{6} (0.025)^3 = 0.571 \text{ N} = C_D \left( \frac{1}{2} \right) (680) U^2 \frac{\pi}{4} (0.025)^2$$

Guess  $C_D \approx 0.4$  and compute  $U \approx 2.9 \frac{\text{m}}{\text{s}}$  Ans.

Now check  $Re_D = \rho U D / \mu = 680(2.9)(0.025) / (2.92E-4) \approx 170000$ . Yes,  $C_D \approx 0.4$ , OK.

**5.50** When a microorganism moves in a viscous fluid, inertia (fluid density) has a negligible influence on the organism's drag force. These are called *creeping flows*. The only important parameters are velocity  $U$ , viscosity  $\mu$ , and body length scale  $L$ . (a) Write this relationship in dimensionless form. (b) The drag coefficient  $C_D = F / (1/2 \rho U^2 A)$  is not appropriate for such flows. Define a more appropriate drag coefficient and call it  $C_c$  (for creeping flow). (c) For a spherical organism, the drag force can be calculated exactly from creeping-flow theory:  $F = 3\pi\mu U d$ . Evaluate both forms of the drag coefficient for creeping flow past a sphere.

**Solution:** (a) If  $F = \text{fcn}(U, \mu, L)$ , then  $n = 4$  and  $j = 3$  (MLT), whence we expect  $n - j = 4 - 3 =$  only *one* pi group, which must therefore be a constant:

$$\Pi_1 = \frac{F}{\mu U L} = \text{Const}, \quad \text{or: } F_{\text{creeping flow}} = \text{Const } \mu U L \quad \text{Ans. (a)}$$

(b) Clearly, the best 'creeping' coefficient is  $\Pi_1$  itself:  $C_c = F / (\mu U L)$ . Ans. (b)

(c) If  $F_{\text{sphere}} = 3\pi\mu U d$ , then  $C_c = F / (\mu U d) = 3\pi$ . Ans. (c—creeping coeff.)

The standard (inappropriate) form of drag coefficient would be

$$C_D = (3\pi\mu U d) / (1/2 \rho U^2 \pi d^2 / 4) = 24\mu / (\rho U d) = 24 / Re_d. \quad \text{Ans. (c—standard)}$$

**5.51** A ship is towing a sonar array which approximates a submerged cylinder 1 ft in diameter and 30 ft long with its axis normal to the direction of tow. If the tow speed is 12 kn (1 kn = 1.69 ft/s), estimate the horsepower required to tow this cylinder. What will be the frequency of vortices shed from the cylinder? Use Figs. 5.2 and 5.3.

**Solution:** For seawater at 20°C, take  $\rho \approx 1.99$  slug/ft<sup>3</sup> and  $\mu \approx 2.23E-5$  slug/ft·s. Convert  $V = 12$  knots  $\approx 20.3$  ft/s. Then the Reynolds number and drag of the towed cylinder is

$$Re_D = \frac{\rho U D}{\mu} = \frac{1.99(20.3)(1.0)}{2.23E-5} \approx 1.8E6. \quad \text{Fig. 5.3(a) cylinder: Read } C_D \approx 0.3$$

$$\text{Then } F = C_D \left(\frac{1}{2}\right) \rho U^2 D L = (0.3) \left(\frac{1}{2}\right) (1.99)(20.3)^2 (1)(30) \approx 3700 \text{ lbf}$$

$$\text{Power } P = F U = (3700)(20.3) \div 550 \approx 140 \text{ hp} \quad \text{Ans. (a)}$$

Data for cylinder vortex shedding is found from Fig. 5.2*b*. At a Reynolds number  $Re_D \approx 1.8E6$ , read  $fD/U \approx 0.24$ . Then

$$f_{shedding} = \frac{StU}{D} = \frac{(0.24)(20.3 \text{ ft/s})}{1.0 \text{ ft}} \approx \mathbf{5 \text{ Hz}} \quad \text{Ans. (b)}$$

**5.52** A 1-in-diameter telephone wire is mounted in air at 20°C and has a natural vibration frequency of 12 Hz. What wind velocity in ft/s will cause the wire to sing? At this condition what will the average drag force per unit wire length be?

**Solution:** For air at 20°C, take  $\rho \approx 0.00234 \text{ slug/ft}^3$  and  $\mu \approx 3.76E-7 \text{ slug/ft}\cdot\text{s}$ . Then

$$\text{Guess } f_{\text{Fig. 5.2}} \approx 0.2 = \frac{(12 \text{ Hz})(1/12 \text{ ft})}{U}, \quad \text{or } U \approx \mathbf{5 \frac{\text{ft}}{\text{s}}}$$

$$\text{Check } Re_D = \rho U D / \mu = (0.00234)(5)(1/12) / 3.76E-7 \approx 2600: \quad \text{OK, } f \approx 0.2 \text{ (check)}$$

For drag force, read Fig. 5.3(a) for a cylinder at  $Re_D \approx 2600$ :  $C_D \approx 1.2$ . Then

$$F_{\text{per ft}} = C_D \frac{1}{2} \rho U^2 D L = (1.2) \left( \frac{1}{2} \right) (0.00234)(5)^2 \left( \frac{1}{12} \right) (1) \approx \mathbf{0.003 \frac{\text{lbf}}{\text{ft}\cdot\text{width}}} \quad \text{Ans. (b)}$$

**5.53** Vortex shedding can be used to design a *vortex flowmeter* (Fig. 6.34). A blunt rod stretched across the pipe sheds vortices whose frequency is read by the sensor downstream. Suppose the pipe diameter is 5 cm and the rod is a cylinder of diameter 8 mm. If the sensor reads 5400 counts per minute, estimate the volume flow rate of water in  $\text{m}^3/\text{h}$ . How might the meter react to other liquids?

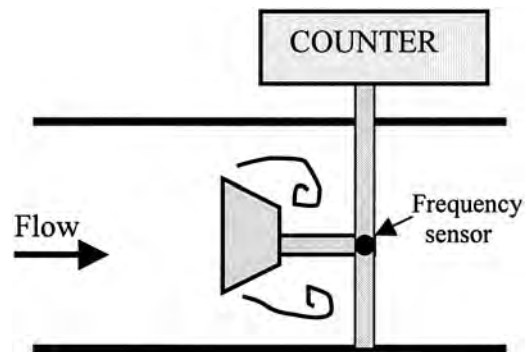


Fig. 6.34

**Solution:**  $5400 \text{ counts/min} = 90 \text{ Hz} = f$ .

$$\text{Guess } \frac{fD}{U} \approx 0.2 = \frac{90(0.008)}{U}, \quad \text{or } U \approx \mathbf{3.6 \frac{\text{m}}{\text{s}}}$$

$$\text{Check } \text{Re}_{D,\text{water}} = \frac{998(3.6)(0.008)}{0.001} \approx 29000; \quad \text{Fig. 5.2: Read } \text{St} \approx 0.2, \quad \text{OK.}$$

If the centerline velocity is 3.6 m/s and the flow is turbulent, then  $V_{\text{avg}} \approx 0.82V_{\text{center}}$  (see Ex. 3.4 of the text). Then the pipe volume flow is approximately:

$$Q = V_{\text{avg}} A_{\text{pipe}} = (0.82 \times 3.6) \frac{\pi}{4} (0.05 \text{ m})^2 \approx 0.0058 \frac{\text{m}^3}{\text{s}} \approx \mathbf{21 \frac{\text{m}^3}{\text{hr}}} \quad \text{Ans.}$$

**5.54** A fishnet is made of 1-mm-diameter strings knotted into  $2 \times 2$  cm squares. Estimate the horsepower required to tow  $300 \text{ ft}^2$  of this netting at 3 kn in seawater at  $20^\circ\text{C}$ . The net plane is normal to the flow direction.

**Solution:** For seawater at  $20^\circ\text{C}$ , take  $\rho \approx 1025 \text{ kg/m}^3$  and  $\mu \approx 0.00107 \text{ kg/m}\cdot\text{s}$ . Convert  $V = 3 \text{ knots} = 1.54 \text{ m/s}$ . Then, considering the strings as “cylinders in crossflow,” the Reynolds number is  $\text{Re}$

$$\text{Re}_D = \frac{\rho V D}{\mu} = \frac{(1025)(1.54)(0.001)}{0.00107} \approx 1500; \quad \text{Fig. 5.3(a): } C_{D,\text{cyl}} \approx 1.0$$

Drag of one 2-cm strand:

$$F = C_D \frac{\rho}{2} V^2 D L = (1.0) \left( \frac{1025}{2} \right) (1.54)^2 (0.001)(0.02) \approx 0.0243 \text{ N}$$

Now  $1 \text{ m}^2$  of net contains 5000 of these 2-cm strands, and  $300 \text{ ft}^2 = 27.9 \text{ m}^2$  of net contains  $(5000)(27.9) = 139400$  strands total, for a total net force  $F = 139400(0.0243) \approx 3390 \text{ N} \div 4.4482 = \mathbf{762 \text{ lbf}}$  on the net. Then the horsepower required to tow the net is

$$\text{Power} = FV = (3390 \text{ N})(1.54 \text{ m/s}) = 5220 \text{ W} \div 746 \approx \mathbf{7.0 \text{ hp}} \quad \text{Ans.}$$

**5.55** The radio antenna on a car begins to vibrate wildly at **8 Hz** when the car is driven at 45 mi/h over a rutted road which approximates a sine wave of amplitude 2 cm and wavelength  $\lambda = 2.5 \text{ m}$ . The antenna diameter is 4 mm. Is the vibration due to the road or to vortex shedding?

**Solution:** Convert  $U = 45 \text{ mi/h} = 20.1 \text{ m/s}$ . Assume sea level air,  $\rho = 1.2 \text{ kg/m}^3$ ,  $\mu = 1.8\text{E}-5 \text{ kg/m}\cdot\text{s}$ . Check the Reynolds number based on antenna diameter:  $\text{Re}_d = (1.2)(20.1)(0.004)/(1.8\text{E}-5) = 5400$ . From Fig. 5.2b, read  $\text{St} \approx 0.21 = (\omega/2\pi)d/U = (f_{\text{shed}})(0.004 \text{ m})/(20.1 \text{ m/s})$ , or  $f_{\text{shed}} \approx 1060 \text{ Hz} \neq 8 \text{ Hz}$ , so **rule out** vortex shedding.

Meanwhile, the rutted road introduces a forcing frequency  $f_{\text{road}} = U/\lambda = (20.1 \text{ m/s})/(2.5 \text{ m}) \approx 8.05 \text{ Hz}$ . We conclude that this resonance is due to **road roughness**.

**5.56** Flow past a long cylinder of square cross-section results in more drag than the comparable round cylinder. Here are data taken in a water tunnel for a square cylinder of side length  $b = 2 \text{ cm}$ :

$V, \text{ m/s}:$	1.0	2.0	3.0	4.0
Drag, N/(m of depth):	21	85	191	335

(a) Use this data to predict the drag force per unit depth of wind blowing at 6 m/s, in air at 20°C, over a tall square chimney of side length  $b = 55 \text{ cm}$ . (b) Is there any uncertainty in your estimate?

**Solution:** Convert the data to the dimensionless form  $F/(\rho V^2 bL) = \text{fcn}(\rho Vb/\mu)$ , like Eq. (5.2). For air, take  $\rho = 1.2 \text{ kg/m}^3$  and  $\mu = 1.8\text{E-}5 \text{ kg/m}\cdot\text{s}$ . For water, take  $\rho = 998 \text{ kg/m}^3$  and  $\mu = 0.001 \text{ kg/m}\cdot\text{s}$ . Make a new table using the water data, with  $L = 1 \text{ m}$ :

$F/(\rho V^2 bL):$	1.05	1.06	1.06	1.05
$\rho Vb/\mu:$	19960	39920	59880	79840

In this Reynolds number range, the force coefficient is approximately constant at about 1.055. Use this value to estimate the air drag on the large chimney:

$$F_{\text{air}} = C_F \rho_{\text{air}} V_{\text{air}}^2 (bL)_{\text{chimney}} = (1.055) \left( 1.2 \frac{\text{kg}}{\text{m}^3} \right) \left( 6 \frac{\text{m}}{\text{s}} \right)^2 (0.55 \text{ m})(1 \text{ m}) \approx \mathbf{25 \text{ N/m}} \quad \text{Ans. (a)}$$

(b) Yes, there is uncertainty, because  $\text{Re}_{\text{chimney}} = 220,000 > \text{Re}_{\text{model}} = 80,000$  or less.

**5.57** The simply supported 1040 carbon-steel rod of Fig. P5.57 is subjected to a crossflow stream of air at 20°C and 1 atm. For what stream velocity  $U$  will the rod center deflection be approximately 1 cm?

**Solution:** For air at 20°C, take  $\rho \approx 1.2 \text{ kg/m}^3$  and  $\mu \approx 1.8\text{E-}5 \text{ kg/m}\cdot\text{s}$ . For carbon steel take Young's modulus  $E \approx 29\text{E}6 \text{ psi} \approx 2.0\text{E}11 \text{ Pa}$ .

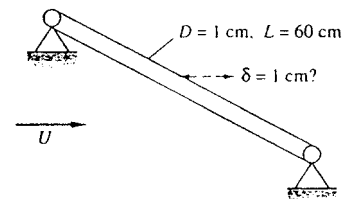


Fig. P5.57

This is not an elasticity course, so just use the formula for center deflection of a simply-supported beam:

$$\delta_{\text{center}} = \frac{FL^3}{48EI} = 0.01 \text{ m} = \frac{F(0.6)^3}{48(2.0\text{E}11)[(\pi/4)(0.005)^4]}, \quad \text{solve for } F \approx 218 \text{ N}$$

$$\text{Guess } C_D \approx 1.2, \quad \text{then } F = 218 \text{ N} = C_D \frac{\rho}{2} V^2 DL = (1.2) \left( \frac{1.2}{2} \right) V^2 (0.01)(0.6)$$

Solve for  $V \approx 225 \text{ m/s}$ , check  $Re_D = \rho VD/\mu \approx 150,000$ : OK,  $C_D \approx 1.2$  from Fig. 5.3a.

Then  $V \approx \mathbf{225 \text{ m/s}}$ , which is quite high subsonic speed, Mach number  $\approx 0.66$ . *Ans.*

**5.58** For the steel rod of Prob. 5.57, at what airstream velocity  $U$  will the rod begin to vibrate laterally in resonance in its first mode (a half sine wave)? (*Hint: Consult a vibration text under "lateral beam vibration."*)

**Solution:** From a vibrations book, the first mode frequency for a simply-supported slender beam is given by

$$\omega_n = \pi^2 \sqrt{\frac{EI}{mL^4}} \quad \text{where } m = \rho_{\text{steel}} \pi R^2 = \text{beam mass per unit length}$$

$$\text{Thus } f_n = \frac{\omega_n}{2\pi} = \frac{\pi}{2} \left[ \frac{2.0\text{E}11(\pi/4)(0.005)^4}{(7840)\pi(0.005)^2(0.6)^4} \right]^{1/2} \approx 55.1 \text{ Hz}$$

The beam will resonate if its vortex shedding frequency is the same. Guess  $fD/U \approx 0.2$ :

$$St = \frac{fD}{U} \approx 0.2 = \frac{55.1(0.01)}{U}, \quad \text{or } U \approx 2.8 \frac{\text{m}}{\text{s}}$$

Check  $Re_D = \rho VD/\mu \approx 1800$ . Fig. 5.2, OK,  $St \approx 0.2$ . Then  $V \approx \mathbf{2.8 \frac{m}{s}}$  *Ans.*

**5.59** Modify Prob. 5.55 as follows. If the circular antenna is steel, with  $L = 60 \text{ cm}$ , and the car speed is  $45 \text{ mi/h}$ , what rod diameter would cause the natural vibration frequency to equal the shedding frequency and thus be in a resonant condition?

**Solution:** For steel take Young's modulus  $E = 2.1\text{E}11 \text{ Pa}$  and  $\rho = 7840 \text{ kg/m}^3$ . Look up the natural frequency of a circular-cross-section elastic cantilever beam and set the two frequencies equal:

$$\omega_n = 1.758 \sqrt{\frac{E}{\rho} \frac{R}{L^2}} = 1.758 \sqrt{\frac{2.1\text{E}11}{7840} \frac{R}{0.6^2}} = \omega_{\text{shed}} \approx \frac{0.21(2\pi U)}{2R} = \frac{0.21(2\pi)(20.1)}{2R}$$



solve for  $R^2 = 0.000525$ ,  $R = 0.0229$  m, or: **D ≈ 0.046 m** Ans.

By substituting back, we would find  $\omega_h = \omega_{shed} = 579$  rad/s = 92 Hz. Thus, resonance is possible in theory, but the large antenna diameter (nearly 2 inches) is ridiculous.

**5.60** A prototype water pump has an impeller diameter of 2 ft and is designed to pump  $12 \text{ ft}^3/\text{s}$  at 750 r/min. A 1-ft-diameter model pump is tested in  $20^\circ\text{C}$  air at 1800 r/min, and Reynolds-number effects are found to be negligible. For similar conditions, what will the volume flow of the model be in  $\text{ft}^3/\text{s}$ ? If the model pump requires 0.082 hp to drive it, what horsepower is required for the prototype?

**Solution:** For air at  $20^\circ\text{C}$ , take  $\rho \approx 0.00234$  slug/ $\text{ft}^3$ . For water at  $20^\circ\text{C}$ , take  $\rho \approx 1.94$  slug/ $\text{ft}^3$ . The proper Pi groups for this problem are  $P/\rho\Omega^3D^5 = \text{fcn}(Q/\Omega D^3, \rho\Omega D^2/\mu)$ . Neglecting  $\mu$ :

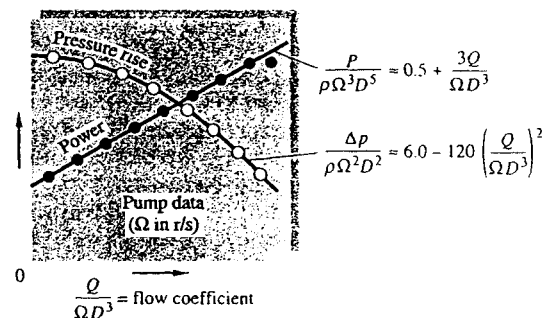
$$\frac{P}{\rho\Omega^3D^5} = \text{fcn}\left(\frac{Q}{\Omega D^3}\right) \quad \text{if Reynolds number is unimportant}$$

$$\text{Then } Q_{\text{model}} = Q_p (\Omega_m/\Omega_p)(D_m/D_p)^3 = 12 \left(\frac{1800}{750}\right) \left(\frac{1.0}{2.0}\right)^3 \approx \mathbf{3.6 \frac{ft^3}{s}} \quad \text{Ans.}$$

$$\text{Similarly, } P_p = P_m (\rho_p/\rho_m)(\Omega_p/\Omega_m)^3 (D_p/D_m)^5 = 0.082 \left(\frac{1.94}{0.00234}\right) \left(\frac{750}{1800}\right)^3 \left(\frac{2.0}{1.0}\right)^5$$

$$\text{or } P_{\text{proto}} \approx \mathbf{157 \text{ hp}} \quad \text{Ans.}$$

**5.61** If viscosity is neglected, typical pump-flow results are shown in Fig. P5.61 for a model pump tested in water. The pressure rise decreases and the power required increases with the dimensionless flow coefficient. Curve-fit expressions are given for the data. Suppose a similar pump of 12-cm diameter is built to move gasoline at  $20^\circ\text{C}$  and a flow rate of  $25 \text{ m}^3/\text{h}$ . If the pump rotation speed is 30 r/s, find (a) the pressure rise and (b) the power required.



**Fig. P5.61**

**Solution:** For gasoline at 20°C, take  $\rho \approx 680 \text{ kg/m}^3$  and  $\mu \approx 2.92\text{E-}4 \text{ kg/m}\cdot\text{s}$ . Convert  $Q = 25 \text{ m}^3/\text{hr} = 0.00694 \text{ m}^3/\text{s}$ . Then we can evaluate the “flow coefficient”:

$$\frac{Q}{\Omega D^3} = \frac{0.00694}{(30)(0.12)^3} \approx 0.134, \quad \text{whence} \quad \frac{\Delta p}{\rho \Omega^2 D^2} \approx 6 - 120(0.134)^2 \approx 3.85$$

$$\text{and} \quad \frac{P}{\rho \Omega^3 D^5} \approx 0.5 + 3(0.134) \approx 0.902$$

With the dimensionless pressure rise and dimensionless power known, we thus find

$$\Delta p = (3.85)(680)(30)^2(0.12)^2 \approx \mathbf{34000 \text{ Pa}} \quad \text{Ans. (a)}$$

$$P = (0.902)(680)(30)^3(0.12)^5 \approx \mathbf{410 \text{ W}} \quad \text{Ans. (b)}$$

**5.62** Modify Prob. 5.61 so that the rotation speed is unknown but  $D = 12 \text{ cm}$  and  $Q = 25 \text{ m}^3/\text{h}$ . What is the maximum rotation speed for which the power will not exceed 300 W? What will the pressure rise be for this condition?

**Solution:** For gasoline at 20°C, take  $\rho \approx 680 \text{ kg/m}^3$ . With power known, we solve for  $\Omega$ :

$$\frac{P}{\rho \Omega^3 D^5} = \frac{300}{680 \Omega^3 (0.12)^5} \approx 0.5 + \frac{3(25/3600)}{\Omega (0.12)^3}, \quad \text{solve for } \Omega_{\max} \approx \mathbf{26.5 \frac{\text{rev}}{\text{s}}} \quad \text{Ans.}$$

$$\text{Then} \quad \frac{\Delta p}{680(26.5)^2(0.12)^2} \approx 6 - 120 \left[ \frac{(25/3600)}{26.5(0.12)^3} \right]^2 \approx 3.24,$$

$$\text{or: } \Delta p \approx \mathbf{22300 \text{ Pa}} \quad \text{Ans.}$$

**5.63** The pressure drop per unit length  $\Delta p/L$  in smooth pipe flow is known to be a function only of the average velocity  $V$ , diameter  $D$ , and fluid properties  $\rho$  and  $\mu$ . The following data were obtained for flow of water at 20°C in an 8-cm-diameter pipe 50 m long:

$Q, \text{ m}^3/\text{s}$	0.005	0.01	0.015	0.020
$\Delta p, \text{ Pa}$	5800	20,300	42,100	70,800

Verify that these data are slightly outside the range of Fig. 5.10. What is a suitable power-law curve fit for the present data? Use these data to estimate the pressure drop for

flow of kerosene at 20°C in a smooth pipe of diameter 5 cm and length 200 m if the flow rate is 50 m<sup>3</sup>/h.

**Solution:** For water at 20°C, take  $\rho \approx 998 \text{ kg/m}^3$  and  $\mu \approx 0.001 \text{ kg/m}\cdot\text{s}$ . In the spirit of Fig. 5.10 and Example 5.7 in the text, we generate dimensionless  $\Delta p$  and  $V$ :

$Q, \text{ m}^3/\text{s}:$	0.005	0.010	0.015	0.020
$V = Q/A, \text{ m/s}:$	0.995	1.99	2.98	3.98
$Re = \rho VD/\mu:$	79400	158900	238300	317700
$\rho D^3 \Delta p / (L\mu^2):$	5.93E7	2.07E8	4.30E8	7.24E8

These data, except for the first point, exceed  $Re = 1E6$  and are thus off to the right of the plot in Fig. 5.10. They could fit a “1.75” Power-law, as in *Ans. (c)* as in Ex. 5.7 of the text, but only to  $\pm 4\%$ . They fit a “1.80” power-law much more accurately:

$$\frac{\rho \Delta p D^3}{L\mu^2} \approx 0.0901 \left( \frac{\rho VD}{\mu} \right)^{1.80} \pm 1\%$$

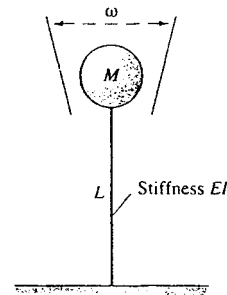
For kerosene at 20°C, take  $\rho \approx 804 \text{ kg/m}^3$  and  $\mu \approx 1.92E-3 \text{ kg/m}\cdot\text{s}$ . The new length is 200 m, the new diameter is 5 cm, and the new flow rate is 50 m<sup>3</sup>/hr. Then evaluate  $Re$ :

$$V = \frac{50/3600}{(\pi/4)(0.05)^2} \approx 7.07 \frac{\text{m}}{\text{s}}, \quad \text{and} \quad Re_D = \frac{\rho VD}{\mu} = \frac{804(7.07)(0.05)}{1.92E-3} \approx 148100$$

$$\text{Then } \rho \Delta p D^3 / (L\mu^2) \approx 0.0901(148100)^{1.80} \approx 1.83E8 = \frac{(804)\Delta p(0.05)^3}{(200)(1.92E-3)^2}$$

Solve for  $\Delta p \approx 1.34E6 \text{ Pa}$  *Ans.*

**5.64** The natural frequency  $\omega$  of vibration of a mass  $M$  attached to a rod, as in Fig. P5.64, depends only upon  $M$  and the stiffness  $EI$  and length  $L$  of the rod. Tests with a 2-kg mass attached to a 1040 carbon-steel rod of diameter 12 mm and length 40 cm reveal a natural frequency of 0.9 Hz. Use these data to predict the natural frequency of a 1-kg mass attached to a 2024 aluminum-alloy rod of the same size.



**Fig. P5.64**

**Solution:** For steel,  $E \approx 29E6 \text{ psi} \approx 2.03E11 \text{ Pa}$ . If  $\omega = f(M, EI, L)$ , then  $n = 4$  and  $j = 3$  (MLT), hence we get only 1 pi group, which we can evaluate from the steel data:

$$\frac{\omega(\text{ML}^3)^{1/2}}{(EI)^{1/2}} = \text{constant} = \frac{0.9[(2.0)(0.4)^3]^{1/2}}{[(2.03E11)(\pi/4)(0.006)^4]^{1/2}} \approx 0.0224$$

For 2024 aluminum,  $E \approx 10.6E6 \text{ psi} \approx 7.4E10 \text{ Pa}$ . Then re-evaluate the same pi group:

$$\text{New } \frac{\omega(\text{ML}^3)^{1/2}}{(EI)^{1/2}} = 0.0224 = \frac{\omega[(1.0)(0.4)^3]^{1/2}}{[(7.4E10)(\pi/4)(0.006)^4]^{1/2}}, \text{ or } \omega_{\text{alum}} \approx \mathbf{0.77 \text{ Hz}} \text{ Ans.}$$

**5.65** In turbulent flow near a flat wall, the local velocity  $u$  varies only with distance  $y$  from the wall, wall shear stress  $\tau_w$ , and fluid properties  $\rho$  and  $\mu$ . The following data were taken in the University of Rhode Island wind tunnel for airflow,  $\rho = 0.0023 \text{ slug/ft}^3$ ,  $\mu = 3.81E-7 \text{ slug/(ft}\cdot\text{s)}$ , and  $\tau_w = 0.029 \text{ lbf/ft}^2$ :

$y$ , in	0.021	0.035	0.055	0.080	0.12	0.16
$u$ , ft/s	50.6	54.2	57.6	59.7	63.5	65.9

(a) Plot these data in the form of dimensionless  $u$  versus dimensionless  $y$ , and suggest a suitable power-law curve fit. (b) Suppose that the tunnel speed is increased until  $u = 90 \text{ ft/s}$  at  $y = 0.11 \text{ in}$ . Estimate the new wall shear stress, in  $\text{lbf/ft}^2$ .

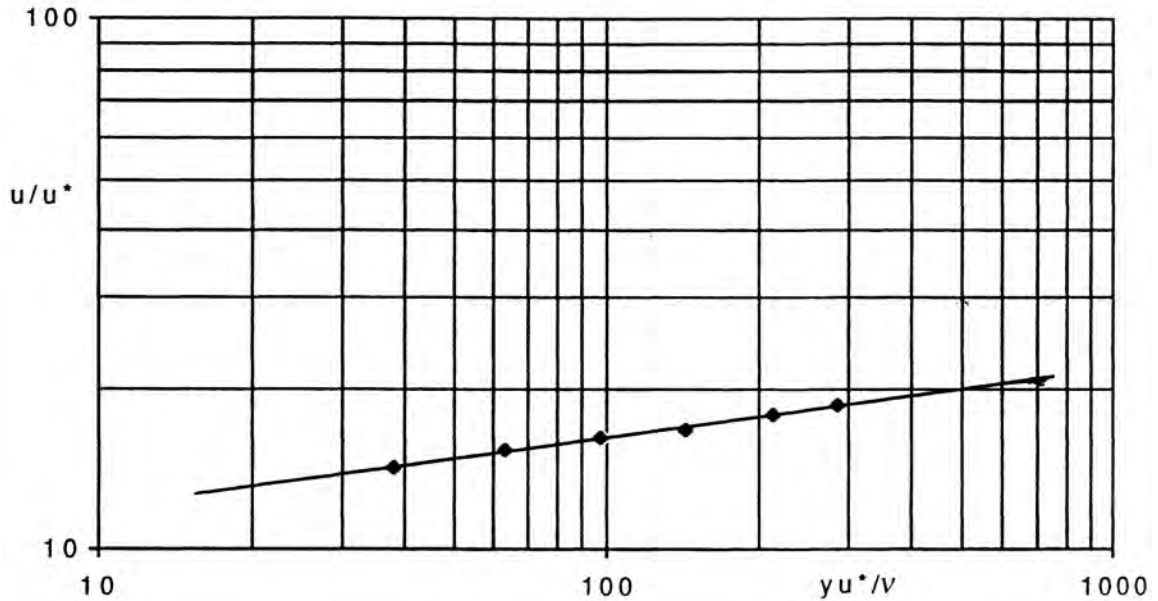
**Solution:** Given that  $u = \text{fcn}(y, \tau_w, \rho, \mu)$ , then  $n = 5$  and  $j = 3$  (MLT), so we expect  $n - j = 5 - 3 = 2$  pi groups, and they are traditionally chosen as follows (Chap. 6, Section 6.5):

$$\frac{u}{u^*} = \text{fcn}\left(\frac{\rho u^* y}{\mu}\right), \text{ where } u^* = (\tau_w/\rho)^{1/2} = \text{the 'friction velocity'}$$

We may compute  $u^* = (\tau_w/\rho)^{1/2} = (0.029/0.0023)^{1/2} = 3.55 \text{ ft/s}$  and then modify the given data into dimensionless parameters:

$y$ , in:	0.021	0.035	0.055	0.080	0.12	0.16
$\rho u^* y/\mu$ :	38	63	98	143	214	286
$u/u^*$ :	14.3	15.3	16.2	16.8	17.9	18.6

When plotted on log-log paper as follows, they form nearly a straight line:



The slope of the line is 0.13 and its intercept (at  $yu^*/\nu = 1$ ) is 8.9. Hence the formula:

$$u/u^* \approx 8.9(yu^*/\nu)^{0.13} \pm 1\% \quad \text{Ans. (a)}$$

Now if the tunnel speed is increased until  $u = 90$  ft/s at  $y = 0.11$  in, we may substitute in:

$$\frac{90}{u^*} \approx 8.9 \left[ \frac{0.0023(0.11/12)u^*}{3.87E-7} \right]^{0.13}, \quad \text{solve for } u^* \approx 4.89 \text{ ft/s}$$

$$\text{Solve for } \tau_w = \rho u^{*2} = (0.0023)(4.89)^2 \approx \mathbf{0.055 \text{ lbf/ft}^2} \quad \text{Ans. (b)}$$

**5.66** A torpedo 8 m below the surface in 20°C seawater cavitates at a speed of 21 m/s when atmospheric pressure is 101 kPa. If Reynolds-number and Froude-number effects are negligible, at what speed will it cavitate when running at a depth of 20 m? At what depth should it be to avoid cavitation at 30 m/s?

**Solution:** For seawater at 20°C, take  $\rho = 1025 \text{ kg/m}^3$  and  $p_v = 2337 \text{ Pa}$ . With Reynolds and Froude numbers neglected, the cavitation numbers must simply be the same:

$$Ca = \frac{p_a + \rho g z - p_v}{\rho V^2} \quad \text{for Flow 1} = \frac{101000 + (1025)(9.81)(8) - 2337}{(1025)(21)^2} \approx 0.396$$

$$(a) \text{ At } z = 20 \text{ m: } Ca = 0.396 = \frac{101000 + 1025(9.81)(20) - 2337}{1025V_a^2},$$

$$\text{or } V_a \approx 27.2 \frac{\text{m}}{\text{s}} \quad \text{Ans. (a)}$$

$$(b) \text{ At } V_b = 30 \frac{\text{m}}{\text{s}}: Ca = 0.396 = \frac{101000 + 1025(9.81)z_b - 2337}{1025(30)^2},$$

$$\text{or } z_b \approx 26.5 \text{ m} \quad \text{Ans. (b)}$$

**5.67** A student needs to measure the drag on a prototype of characteristic length  $d_p$  moving at velocity  $U_p$  in air at sea-level conditions. He constructs a model of characteristic length  $d_m$ , such that the ratio  $d_p/d_m = a$  factor  $f$ . He then measures the model drag under dynamically similar conditions, in sea-level air. The student claims that the drag force on the prototype will be identical to that of the model. Is this claim correct? Explain.

**Solution:** Assuming no compressibility effects, dynamic similarity requires that

$$Re_m = Re_p, \quad \text{or: } \frac{\rho_m U_m d_m}{\mu_m} = \frac{\rho_p U_p d_p}{\mu_p}, \quad \text{whence } \frac{U_m}{U_p} = \frac{d_p}{d_m} = f$$

Run the tunnel at “ $f$ ” times the prototype speed, then drag coefficients match:

$$\frac{F_m}{\rho_m U_m^2 d_m^2} = \frac{F_p}{\rho_p U_p^2 d_p^2}, \quad \text{or: } \frac{F_m}{F_p} = \left( \frac{U_m d_m}{U_p d_p} \right)^2 = \left( \frac{f}{f} \right)^2 = 1 \quad \text{Yes, drags are the same!}$$

**5.68** Consider viscous flow over a very small object. Analysis of the equations of motion shows that the inertial terms are much smaller than viscous and pressure terms. Fluid density drops out, and these are called *creeping flows*. The only important parameters are velocity  $U$ , viscosity  $\mu$ , and body length scale  $d$ . For three-dimensional bodies, like spheres, creeping-flow analysis yields very good results. It is uncertain, however, if creeping flow applies to two-dimensional bodies, such as cylinders, since even though the diameter may be very small, the length of the cylinder is infinite. Let us see if dimensional analysis can help.

(a) Apply the Pi theorem to two-dimensional drag force  $F_{2-D}$  as a function of the other parameters. Be careful: two-dimensional drag has dimensions of *force per unit length*, not simply force. (b) Is your analysis in part (a) physically plausible? If not, explain why not.

(c) It turns out that fluid density  $\rho$  cannot be neglected in analysis of creeping flow over two-dimensional bodies. Repeat the dimensional analysis, this time including  $\rho$  as a variable, and find the resulting nondimensional relation between the parameters in this problem.

**Solution:** If we assume, as given, that  $F_{2-D} = \text{fcn}(\mu, U, d)$ , then the dimensions are

$$\{F_{2-D}\} = \{M/T^2\}; \quad \{\mu\} = \{M/LT\}; \quad \{U\} = \{L/T\}; \quad \{d\} = \{L\}$$

Thus  $n = 4$  and  $j = 3$  (MLT), hence we expect  $n - j =$  only *one* Pi group, which is

$$\Pi_1 = \frac{F_{2-D}}{\mu U} = \text{Const}, \quad \text{or: } F_{2-D} = \text{Const } \mu U \quad \text{Ans. (a)}$$

(b) Is this physically plausible? **No**, because it states that *the body drag is independent of its size L*. Therefore something has been left out of the analysis:  $\rho$ . Ans. (b)

(c) If density is added, we have  $F_{2-D} = \text{fcn}(\rho, \mu, U, d)$ , and a *second* Pi group appears:

$$\Pi_2 = \frac{\rho U d}{\mu} = Re_d; \quad \text{Thus, realistically, } \frac{F_{2-D}}{\mu U} = \text{fcn}\left(\frac{\rho U d}{\mu}\right) \quad \text{Ans. (c)}$$

Experimental data and theory for *two*-dimensional bodies agree with part (c).

**5.69** A simple flow-measurement device for streams and channels is a notch, of angle  $\alpha$ , cut into the side of a dam, as shown in Fig. P5.69. The volume flow  $Q$  depends only on  $\alpha$ , the acceleration of gravity  $g$ , and the height  $\delta$  of the upstream water surface above the notch vertex. Tests of a model notch, of angle  $\alpha = 55^\circ$ , yield the following flow rate data:

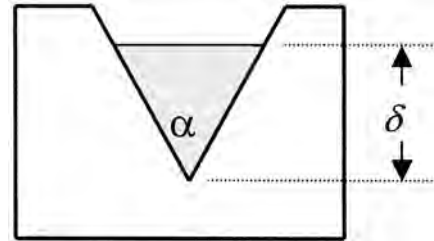


Fig. P5.69

$\delta$ , cm:	10	20	30	40
$Q$ , m <sup>3</sup> /h:	8	47	126	263

(a) Find a dimensionless correlation for the data. (b) Use the model data to predict the flow rate of a prototype notch, also of angle  $\alpha = 55^\circ$ , when the upstream height  $\delta$  is 3.2 m.

**Solution:** (a) The appropriate functional relation is  $Q = \text{fcn}(\alpha, g, \delta)$  and its dimensionless form is  $Q/(g^{1/2} \delta^{5/2}) = \text{fcn}(\alpha)$ . Recalculate the data in this dimensionless form, with  $\alpha$  constant:

$$Q/(g^{1/2} \delta^{5/2}) = \mathbf{0.224} \quad \mathbf{0.233} \quad \mathbf{0.227} \quad \mathbf{0.230} \quad \text{respectively} \quad \text{Ans. (a)}$$

(b) The average coefficient in the data is about 0.23. Since the notch angle is still  $55^\circ$ , we may use the formula to predict the larger flow rate:

$$Q_{\text{prototype}} = 0.23 g^{1/2} \delta^{5/2} = 0.23 \left( 9.81 \frac{m}{s^2} \right)^{1/2} (3.2 m)^{5/2} \approx \mathbf{13.2 m^3/s} \quad \text{Ans. (b)}$$

**5.70** A diamond-shaped body, of characteristic length 9 in, has the following measured drag forces when placed in a wind tunnel at sea-level standard conditions:

$V$ , ft/s:	30	38	48	56	61
$F$ , lbf:	1.25	1.95	3.02	4.05	4.81

Use these data to predict the drag force of a similar 15-in diamond placed at similar orientation in  $20^\circ\text{C}$  water flowing at 2.2 m/s.

**Solution:** For sea-level air, take  $\rho = 0.00237 \text{ slug/ft}^3$ ,  $\mu = 3.72\text{E-}7 \text{ slug/ft}\cdot\text{s}$ . For water at  $20^\circ\text{C}$ , take  $\rho = 1.94 \text{ kg/m}^3$ ,  $\mu = 2.09\text{E-}5 \text{ slug/ft}\cdot\text{s}$ . Convert the model data into drag coefficient and Reynolds number, taking  $L_m = 9 \text{ in} = 0.75 \text{ ft}$ :

$V_m$ , ft/s:	30	38	48	56	61
$F/(\rho V^2 L^2)$ :	0.667	0.649	0.630	0.621	0.621
$\rho V L / \mu$ :	143000	182000	229000	268000	291000

An excellent curve-fit to this data is the power-law

$$C_F \approx 2.5 \text{Re}_L^{-0.111} \pm 1\%$$

Now introduce the new case,  $V_{\text{proto}} = 2.2 \text{ m/s} = 7.22 \text{ ft/s}$ ,  $L_{\text{proto}} = 15 \text{ in} = 1.25 \text{ ft}$ . Then  $\text{Re}_{L,\text{proto}} = \frac{1.94(7.22)(1.25)}{2.09\text{E-}5} \approx 837000$ , which is outside the range of the model data.

Strictly speaking, we **cannot** use the model data to predict this new case. *Ans.*

If we wish to *extrapolate* to get an estimate, we obtain

$$C_{F,\text{proto}} \approx \frac{2.5}{(837000)^{0.111}} \approx 0.550 \approx \frac{F_{\text{proto}}}{1.94(7.22)^2(1.25)^2},$$

$$\text{or: } F_{\text{proto}} \approx \mathbf{87 \text{ lbf}} \quad \textit{Approximately}$$

**5.71** The pressure drop in a venturi meter (Fig. P3.165) varies only with the fluid density, pipe approach velocity, and diameter ratio of the meter. A model venturi meter tested in



water at 20°C shows a 5-kPa drop when the approach velocity is 4 m/s. A geometrically similar prototype meter is used to measure gasoline at 20°C and a flow rate of 9 m<sup>3</sup>/min. If the prototype pressure gage is most accurate at 15 kPa, what should the upstream pipe diameter be?

**Solution:** Given  $\Delta p = \text{fcn}(\rho, V, d/D)$ , then by dimensional analysis  $\Delta p/(\rho V^2) = \text{fcn}(d/D)$ . For water at 20°C, take  $\rho = 998 \text{ kg/m}^3$ . For gasoline at 20°C, take  $\rho = 680 \text{ kg/m}^3$ . Then, using the water ‘model’ data to obtain the function “ $\text{fcn}(d/D)$ ”, we calculate

$$\frac{\Delta p_m}{\rho_m V_m^2} = \frac{5000}{(998)(4.0)^2} = 0.313 = \frac{\Delta p_p}{\rho_p V_p^2} = \frac{15000}{(680)V_p^2}, \quad \text{solve for } V_p \approx 8.39 \frac{\text{m}}{\text{s}}$$

$$\text{Given } Q = \frac{9}{60} \frac{\text{m}^3}{\text{s}} = V_p A_p = (8.39) \frac{\pi}{4} D_p^2, \quad \text{solve for best } D_p \approx \mathbf{0.151 \text{ m}} \quad \text{Ans.}$$

**5.72** A one-fifteenth-scale model of a parachute has a drag of 450 lbf when tested at 20 ft/s in a water tunnel. If Reynolds-number effects are negligible, estimate the terminal fall velocity at 5000-ft standard altitude of a parachutist using the prototype if chute and chutist together weigh 160 lbf. Neglect the drag coefficient of the woman.

**Solution:** For water at 20°C, take  $\rho = 1.94 \text{ kg/m}^3$ . For air at 5000-ft standard altitude (Table A-6) take  $\rho = 0.00205 \text{ kg/m}^3$ . If Reynolds number is unimportant, then the two cases have the same drag-force coefficient:

$$C_{Dm} = \frac{F_m}{\rho_m V_m^2 D_m^2} = \frac{450}{1.94(20)^2 (D_p/15)^2} = C_{Dp} = \frac{160}{0.00205 V_p^2 D_p^2},$$

$$\text{solve } V_p \approx \mathbf{24.5 \frac{ft}{s}} \quad \text{Ans.}$$

**5.73** The power  $P$  generated by a certain windmill design depends upon its diameter  $D$ , the air density  $\rho$ , the wind velocity  $V$ , the rotation rate  $\Omega$ , and the number of blades  $n$ . (a) Write this relationship in dimensionless form. A model windmill, of diameter 50 cm, develops 2.7 kW at sea level when  $V = 40 \text{ m/s}$  and when rotating at 4800 rev/min. (b) What power will be developed by a geometrically and dynamically similar prototype, of diameter 5 m, in winds of 12 m/s at 2000 m standard altitude? (c) What is the appropriate rotation rate of the prototype?

**Solution:** (a) For the function  $P = \text{fcn}(D, \rho, V, \Omega, n)$  the appropriate dimensions are  $\{P\} = \{\text{ML}^2\text{T}^{-3}\}$ ,  $\{D\} = \{\text{L}\}$ ,  $\{\rho\} = \{\text{ML}^{-3}\}$ ,  $\{V\} = \{\text{L/T}\}$ ,  $\{\Omega\} = \{\text{T}^{-1}\}$ , and  $\{n\} = \{1\}$ . Using  $(D, \rho, V)$  as repeating variables, we obtain the desired dimensionless function:

$$\frac{P}{\rho D^2 V^3} = \text{fcn}\left(\frac{\Omega D}{V}, n\right) \quad \text{Ans. (a)}$$

(c) “Geometrically similar” means that  $n$  is the same for both windmills. For “dynamic similarity,” the advance ratio  $(\Omega D/V)$  must be the same:

$$\left(\frac{\Omega D}{V}\right)_{\text{model}} = \frac{(4800 \text{ r/min})(0.5 \text{ m})}{(40 \text{ m/s})} = 1.0 = \left(\frac{\Omega D}{V}\right)_{\text{proto}} = \frac{\Omega_{\text{proto}}(5 \text{ m})}{12 \text{ m/s}},$$

or:  $\Omega_{\text{proto}} = 144 \frac{\text{rev}}{\text{min}}$     Ans. (c)

(b) At 2000 m altitude,  $\rho = 1.0067 \text{ kg/m}^3$ . At sea level,  $\rho = 1.2255 \text{ kg/m}^3$ . Since  $\Omega D/V$  and  $n$  are the same, it follows that the power coefficients equal for model and prototype:

$$\frac{P}{\rho D^2 V^3} = \frac{2700 \text{ W}}{(1.2255)(0.5)^2(40)^3} = \frac{P_{\text{proto}}}{(1.0067)(5)^2(12)^3},$$

solve  $P_{\text{proto}} = 5990 \text{ W} \approx 6 \text{ kW}$     Ans. (b)

**5.74** A one-tenth-scale model of a supersonic wing tested at 700 m/s in air at 20°C and 1 atm shows a pitching moment of 0.25 kN·m. If Reynolds-number effects are negligible, what will the pitching moment of the prototype wing be flying at the same Mach number at 8-km standard altitude?

**Solution:** If Reynolds number is unimportant, then the dimensionless moment coefficient  $M/(\rho V^2 L^3)$  must be a function only of the Mach number,  $\text{Ma} = V/a$ . For sea-level air, take  $\rho = 1.225 \text{ kg/m}^3$  and sound speed  $a = 340 \text{ m/s}$ . For air at 8000-m standard altitude (Table A-6), take  $\rho = 0.525 \text{ kg/m}^3$  and sound speed  $a = 308 \text{ m/s}$ . Then

$$\text{Ma}_m = \frac{V_m}{a_m} = \frac{700}{340} = 2.06 = \text{Ma}_p = \frac{V_p}{308}, \quad \text{solve for } V_p \approx 634 \frac{\text{m}}{\text{s}}$$

$$\text{Then } M_p = M_m \left( \frac{\rho_p V_p^2 L_p^3}{\rho_m V_m^2 L_m^3} \right) = 0.25 \left( \frac{0.525}{1.225} \right) \left( \frac{634}{700} \right)^2 \left( \frac{10}{1} \right)^3 \approx 88 \text{ kN}\cdot\text{m} \quad \text{Ans.}$$

**5.75** A one-twelfth-scale model of an airplane is to be tested at 20°C in a pressurized wind tunnel. The prototype is to fly at 240 m/s at 10-km standard altitude. What should the tunnel pressure be in atm to scale both the Mach number and the Reynolds number accurately?

**Solution:** For air at 10000-m standard altitude (Table A-6), take  $\rho = 0.4125 \text{ kg/m}^3$ ,  $\mu = 1.47\text{E-}5 \text{ kg/m}\cdot\text{s}$ , and sound speed  $a = 299 \text{ m/s}$ . At sea level, unless the pressure rise is vast (it isn't),  $T = 288^\circ\text{K}$  and  $\rho = 1.225 \text{ kg/m}^3$ ,  $\mu = 1.80\text{E-}5 \text{ kg/m}\cdot\text{s}$ . Equate Ma and Re:

$$\text{Ma}_p = V_p/a_p = \frac{240}{299} = 0.803 = \text{Ma}_m = V_m/340, \quad \text{solve for } V_{\text{model}} \approx 273 \text{ m/s}$$

$$\text{Re}_p = \frac{\rho_p V_p L_p}{\mu_p} = \frac{0.4125(240)L_p}{1.47\text{E-}5} = \text{Re}_m = \frac{\rho_m (273)(L_p/12)}{1.80\text{E-}5}, \quad \text{solve for } \rho_m = 5.33 \frac{\text{kg}}{\text{m}^3}$$

Then, for an ideal gas,  $p_{\text{model}} = \rho_m RT_m = (5.33)(287)(293) \approx \mathbf{448,000 \text{ Pa} = 4.42 \text{ atm}}$  *Ans.*

**5.76** A 2-ft-long model of a ship is tested in a freshwater tow tank. The measured drag may be split into “friction” drag (Reynolds scaling) and “wave” drag (Froude scaling). The model data are as follows:

Tow speed, ft/s:	0.8	1.6	2.4	3.2	4.0	4.8
Friction drag, lbf:	0.016	0.057	0.122	0.208	0.315	0.441
Wave drag, lbf:	0.002	0.021	0.083	0.253	0.509	0.697

The prototype ship is 150 ft long. Estimate its total drag when cruising at 15 kn in seawater at 20°C.

**Solution:** For fresh water at 20°C, take  $\rho = 1.94 \text{ slug/ft}^3$ ,  $\mu = 2.09\text{E-}5 \text{ slug/ft}\cdot\text{s}$ . Then evaluate the Reynolds numbers and the Froude numbers and respective force coefficients:

$V_m$ , ft/s:	0.8	1.6	2.4	3.2	4.0	4.8
$\text{Re}_m = V_m L_m / \nu$ :	143000	297000	446000	594000	743000	892000
$C_{F,\text{friction}}$ :	0.00322	0.00287	0.00273	0.00261	0.00254	0.00247
$\text{Fr}_m = V_m / \sqrt{gL_m}$ :	0.099	0.199	0.299	0.399	0.498	0.598
$C_{F,\text{wave}}$ :	0.00040	0.00106	0.00186	0.00318	0.00410	0.00390

For seawater, take  $\rho = 1.99 \text{ slug/ft}^3$ ,  $\mu = 2.23\text{E-}5 \text{ slug/ft}\cdot\text{s}$ . With  $L_p = 150 \text{ ft}$  and  $V_p = 15 \text{ knots} = 25.3 \text{ ft/s}$ , evaluate

$$\text{Re}_{\text{proto}} = \frac{\rho_p V_p L_p}{\mu_p} = \frac{1.99(25.3)(150)}{2.23\text{E-}5} \approx 3.39\text{E}8; \quad \text{Fr}_p = \frac{25.3}{[32.2(150)]^{1/2}} \approx 0.364$$

For  $\text{Fr} \approx 0.364$ , interpolate to  $C_{F,\text{wave}} \approx 0.0027$

Thus we can immediately estimate  $F_{\text{wave}} \approx 0.0027(1.99)(25.3)^2(150)^2 \approx 77000 \text{ lbf}$ . However, as mentioned in Fig. 5.8 of the text,  $\text{Re}_p$  is far outside the range of the friction force data, therefore we must *extrapolate* as best we can. A power-law curve-fit is

$$C_{F,\text{friction}} \approx \frac{0.0178}{\text{Re}^{0.144}}, \quad \text{hence } C_{F,\text{proto}} \approx \frac{0.0178}{(3.39\text{E}8)^{0.144}} \approx 0.00105$$

Thus  $F_{\text{friction}} \approx 0.00105(1.99)(25.3)^2(150)^2 \approx 30000 \text{ lbf}$ .  **$F_{\text{total}} \approx 107000 \text{ lbf}$ .** *Ans.*

**5.77** A dam spillway is to be tested by using Froude scaling with a one-thirtieth-scale model. The model flow has an average velocity of  $0.6 \text{ m/s}$  and a volume flow of  $0.05 \text{ m}^3/\text{s}$ . What will the velocity and flow of the prototype be? If the measured force on a certain part of the model is  $1.5 \text{ N}$ , what will the corresponding force on the prototype be?

**Solution:** Given  $\alpha = L_m/L_p = 1/30$ , Froude scaling requires that

$$V_p = \frac{V_m}{\sqrt{\alpha}} = \frac{0.6}{(1/30)^{1/2}} \approx 3.3 \frac{\text{m}}{\text{s}}; \quad Q_p = \frac{Q_m}{\alpha^{5/2}} = \frac{0.05}{(1/30)^{5/2}} \approx 246 \frac{\text{m}^3}{\text{s}} \quad \text{Ans. (a)}$$

The force scales in similar manner, assuming that the density remains constant (water):

$$F_p = F_m \left( \frac{\rho_p}{\rho_m} \right) \left( \frac{V_p}{V_m} \right)^2 \left( \frac{L_p}{L_m} \right)^2 = F_m (1) \left( \frac{1}{\sqrt{\alpha}} \right)^2 \left( \frac{1}{\alpha} \right)^2 = (1.5)(30)^3 \approx 40500 \text{ N} \quad \text{Ans. (b)}$$

**5.78** A prototype spillway has a characteristic velocity of  $3 \text{ m/s}$  and a characteristic length of  $10 \text{ m}$ . A small model is constructed by using Froude scaling. What is the minimum scale ratio of the model which will ensure that its minimum Weber number is  $100$ ? Both flows use water at  $20^\circ\text{C}$ .

**Solution:** For water at  $20^\circ\text{C}$ ,  $\rho = 998 \text{ kg/m}^3$  and  $Y = 0.073 \text{ N/m}$ , for both model and prototype. Evaluate the Weber number of the prototype:

$$\text{We}_p = \frac{\rho_p V_p^2 L_p}{Y_p} = \frac{998(3.0)^2(10.0)}{0.073} \approx 1.23\text{E}6; \quad \text{for Froude scaling,}$$

$$\frac{We_m}{We_p} = \frac{\rho_m}{\rho_p} \left( \frac{V_m}{V_p} \right)^2 \left( \frac{L_m}{L_p} \right) \left( \frac{Y_p}{Y_m} \right) = (1)(\sqrt{\alpha})^2 (\alpha)(1) = \alpha^2 = \frac{100}{1.23E6} \quad \text{if } \alpha = 0.0090$$

Thus the model Weber number will be  $\geq 100$  if  $\alpha = L_m/L_p \geq 0.0090 = 1/111$ . *Ans.*

**5.79** An East Coast estuary has a tidal period of 12.42 h (the semidiurnal lunar tide) and tidal currents of approximately 80 cm/s. If a one-five-hundredth-scale model is constructed with tides driven by a pump and storage apparatus, what should the period of the model tides be and what model current speeds are expected?

**Solution:** Given  $T_p = 12.42$  hr,  $V_p = 80$  cm/s, and  $\alpha = L_m/L_p = 1/500$ . Then:

$$\text{Froude scaling: } T_m = T_p \sqrt{\alpha} = \frac{12.42}{\sqrt{500}} = 0.555 \text{ hr} \approx \mathbf{33 \text{ min}} \quad \text{Ans. (a)}$$

$$V_m = V_p \sqrt{\alpha} = 80/\sqrt{(500)} \approx \mathbf{3.6 \text{ cm/s}} \quad \text{Ans. (b)}$$

**5.80** A prototype ship is 35 m long and designed to cruise at 11 m/s (about 21 kn). Its drag is to be simulated by a 1-m-long model pulled in a tow tank. For Froude scaling find (a) the tow speed, (b) the ratio of prototype to model drag, and (c) the ratio of prototype to model power.

**Solution:** Given  $\alpha = 1/35$ , then Froude scaling determines everything:

$$V_{\text{tow}} = V_m = V_p \sqrt{\alpha} = 11/\sqrt{(35)} \approx \mathbf{1.86 \text{ m/s}}$$

$$F_m/F_p = (V_m/V_p)^2 (L_m/L_p)^2 = (\sqrt{\alpha})^2 (\alpha)^2 = \alpha^3 = (1/35)^3 \approx \frac{\mathbf{1}}{\mathbf{42900}} \quad \text{Ans.}$$

$$P_m/P_p = (F_m/F_p)(V_m/V_p) = \alpha^3 (\sqrt{\alpha}) = \alpha^{3.5} = 1/35^{3.5} \approx \frac{\mathbf{1}}{\mathbf{254000}}$$

**5.81** An airplane, of overall length 55 ft, is designed to fly at 680 m/s at 8000-m standard altitude. A one-thirtieth-scale model is to be tested in a pressurized helium wind tunnel at 20°C. What is the appropriate tunnel pressure in atm? Even at this (high) pressure, exact dynamic similarity is not achieved. Why?

**Solution:** For air at 8000-m standard altitude (Table A-6), take  $\rho = 0.525$  kg/m<sup>3</sup>,  $\mu = 1.53E-5$  kg/m·s, and sound speed  $a = 308$  m/s. For helium at 20°C (Table A-4), take

gas constant  $R = 2077 \text{ J}/(\text{kg}\cdot^\circ\text{K})$ ,  $\mu = 1.97\text{E-}5 \text{ kg}/\text{m}\cdot\text{s}$ , and  $a = 1005 \text{ m}/\text{s}$ . For similarity at this supersonic speed, we must match both the Mach and Reynolds numbers. First convert  $L_p = 55 \text{ ft} = 16.8 \text{ m}$ . Then

$$\text{Ma}_p = \frac{680}{308} = 2.21 = \text{Ma}_m = \frac{V_m}{1005}, \quad \text{solve for } V_{\text{model}} \approx 2219 \frac{\text{m}}{\text{s}}$$

$$\text{Re}_p = \frac{\rho VL}{\mu} \Big|_p = \frac{0.525(680)(16.8)}{1.53\text{E-}5} = 3.91\text{E}8 = \text{Re}_m = \frac{\rho_{\text{He}}(2219)(16.8/30)}{1.97\text{E-}5}$$

$$\text{Solve for } \rho_{\text{He}} \approx 6.21 \text{ kg}/\text{m}^3 = \frac{P}{RT} = \frac{P_{\text{He}}}{(2077)(293)},$$

or  **$p_{\text{He}} \approx 3.78 \text{ MPa} = 37.3 \text{ atm}$**  *Ans.*

Even with Ma and Re matched, true dynamic similarity is not achieved, because the specific heat ratio of helium,  $k \approx 1.66$ , is not equal to  $k_{\text{air}} \approx 1.40$ .

**5.82** A prototype ship is 400 ft long and has a wetted area of 30,000 ft<sup>2</sup>. A one-eightieth-scale model is tested in a tow tank according to Froude scaling at speeds of 1.3, 2.0, and 2.7 kn (1 kn = 1.689 ft/s). The measured friction drag of the model at these speeds is 0.11, 0.24, and 0.41 lbf, respectively. What are the three prototype speeds? What is the estimated prototype friction drag at these speeds if we correct for Reynolds-number discrepancy by extrapolation?

**Solution:** For water at 20°C, take  $\rho = 1.94 \text{ slug}/\text{ft}^3$ ,  $\mu = 2.09\text{E-}5 \text{ slug}/\text{ft}\cdot\text{s}$ . Convert the velocities to ft/sec. Calculate the Reynolds numbers for the model data:

$V_m, \text{ ft/s:}$	2.19	3.38	4.56
$\text{Re}_m = \rho VL/\mu:$	1.02E6	1.57E6	2.12E6
$C_{Fm} = F/\rho V^2 L^2:$	0.000473	0.000433	0.000407

The data may be fit to the Power-law expression  $C_{Fm} \approx \mathbf{0.00805/Re^{0.205}}$ . The related *prototype* speeds are given by Froude scaling,  $V_p = V_m/\sqrt{\alpha}$ , where  $\alpha = 1/80$ :

$V_m, \text{ ft/s:}$	2.19	3.38	4.56	
$V_p, \text{ ft/s:}$	<b>19.6</b>	<b>30.2</b>	<b>40.8</b>	<i>Ans. (a)</i>

Then we may compute the prototype Reynolds numbers and friction drag coefficients:

$$\text{Re}_p = \rho VL/\mu: \quad 7.27\text{E}8 \quad 1.12\text{E}9 \quad 1.51\text{E}9$$

Estimate the friction-drag coefficients by extrapolating the Power-law fit listed previously:

$$C_{Fp} = F/\rho V^2 L^2: \quad 0.000123 \quad 0.000112 \quad 0.000106$$

$$F_p = C_{Fp} \rho V_p^2 L_p^2: \quad \mathbf{14600 \text{ lbf}} \quad \mathbf{31800 \text{ lbf}} \quad \mathbf{54600 \text{ lbf}} \quad \text{Ans. (b)}$$

Among other approximations, this extrapolation assumes very smooth surfaces.

**5.83** A one-fortieth-scale model of a ship's propeller is tested in a tow tank at 1200 r/min and exhibits a power output of 1.4 ft·lbf/s. According to Froude scaling laws, what should the revolutions per minute and horsepower output of the prototype propeller be under dynamically similar conditions?

**Solution:** Given  $\alpha = 1/40$ , use Froude scaling laws:

$$\Omega_p/\Omega_m = T_m/T_p = \sqrt{\alpha}, \quad \text{thus } \Omega_p = \frac{1200}{(40)^{1/2}} \approx \mathbf{190 \frac{\text{rev}}{\text{min}}} \quad \text{Ans. (a)}$$

$$P_p = P_m \left( \frac{\rho_p}{\rho_m} \right) \left( \frac{\Omega_p}{\Omega_m} \right)^3 \left( \frac{D_p}{D_m} \right)^5 = (1.4)(1) \left( \frac{1}{\sqrt{40}} \right)^3 (40)^5$$

$$= 567000 \div 550 = \mathbf{1030 \text{ hp}} \quad \text{Ans. (b)}$$

**5.84** A prototype ocean-platform piling is expected to encounter currents of 150 cm/s and waves of 12-s period and 3-m height. If a one-fifteenth-scale model is tested in a wave channel, what current speed, wave period, and wave height should be encountered by the model?

**Solution:** Given  $\alpha = 1/15$ , apply straight Froude scaling (Fig. 5.6b) to these results:

$$\text{Velocity: } V_m = V_p \sqrt{\alpha} = \frac{150}{\sqrt{15}} = \mathbf{39 \frac{\text{cm}}{\text{s}}}$$

$$\text{Period: } T_m = T_p \sqrt{\alpha} = \frac{12}{\sqrt{15}} = \mathbf{3.1 \text{ s}}; \quad \text{Height: } H_m = \alpha H_p = \frac{3}{15} = \mathbf{0.20 \text{ m}} \quad \text{Ans.}$$

**5.85** Solve Prob. 5.49, using the modified sphere-drag plot of Fig. 5.11.

**Solution:** Recall that the problem was to estimate the terminal velocity of a 2.5-cm-diameter steel sphere falling in gasoline. For gasoline at 20°C, take  $\rho = 680 \text{ kg/m}^3$  and

$\mu = 2.92\text{E-}4 \text{ kg/m}\cdot\text{s}$ . For steel take  $\rho = 7800 \text{ kg/m}^3$ . Then the net sphere weight in gasoline is

$$W_{\text{net}} = (\rho_s - \rho)g \frac{\pi}{6} D^3 = (7800 - 680)(9.81) \frac{\pi}{6} (0.025)^3 = 0.571 \text{ N}$$

$$F_{\text{drag}} = W_{\text{net}}, \quad \text{dimensionless force} = \rho F / \mu^2 = \frac{680(0.571)}{(2.92\text{E-}4)^2} \approx 4.56\text{E}9$$

Fig. 5.11: read  $\text{Re}_D \approx 2\text{E}5$ , whence  $V = \frac{\mu \text{Re}_D}{\rho D} = \frac{(2.92\text{E-}4)(2\text{E}5)}{680(0.025)} \approx 3 \frac{\text{m}}{\text{s}}$  Ans.

You can't read the graph any closer than that. We are very near the 'transition' point.

**5.86** Solve Prob. 5.50, using the modified sphere-drag plot of Fig. 5.11.

**Solution:** Recall this problem is identical to Prob. 5.85 above except that the fluid is **glycerin**, with  $\rho = 1260 \text{ kg/m}^3$  and  $\mu = 1.49 \text{ kg/m}\cdot\text{s}$ . Evaluate the net weight:

$$W = (7800 - 1260)(9.81) \frac{\pi}{6} (0.025)^3 \approx 0.525 \text{ N}, \quad \text{whence} \quad \frac{\rho F}{\mu^2} = \frac{1260(0.525)}{(1.49)^2} \approx 298$$

From Fig. 5.11 read  $\text{Re} \approx 15$ , or  $V = 15(1.49)/[1260(0.025)] \approx 0.7 \text{ m/s}$ . Ans.

**5.87** In Prob. 5.62 it was difficult to solve for  $\Omega$  because it appeared in both power and flow coefficients. Rescale the problem, using the data of Fig. P5.61, to make a plot of dimensionless power versus dimensionless rotation speed. Enter this plot directly to solve Prob. 5.62 for  $\Omega$ .

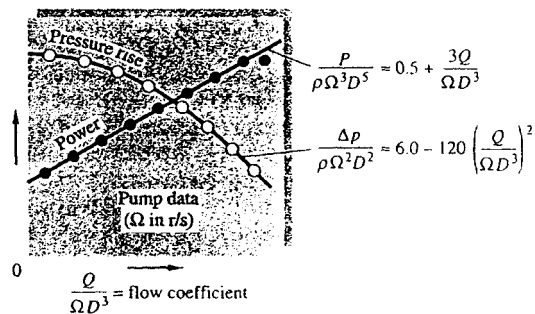


Fig. P5.61

**Solution:** Recall that the problem was to find the speed  $\Omega$  for this pump family if  $D = 12 \text{ cm}$ ,  $Q = 25 \text{ m}^3/\text{hr}$ , and  $P = 300 \text{ W}$ , in gasoline,  $\rho = 680 \text{ kg/m}^3$  and  $\mu = 2.92\text{E-}4 \text{ kg/m}\cdot\text{s}$ . We can eliminate  $\Omega$  from the power coefficient for a new type of coefficient:

$$\Pi_3 = \frac{P}{\rho \Omega^3 D^5} \cdot \frac{\Omega^3 D^9}{Q^3} = \frac{P D^4}{\rho Q^3}, \quad \text{to be plotted versus} \quad \frac{Q}{\Omega D^3}$$



The plot is shown below, as computed from the expressions in Fig. P5.61.

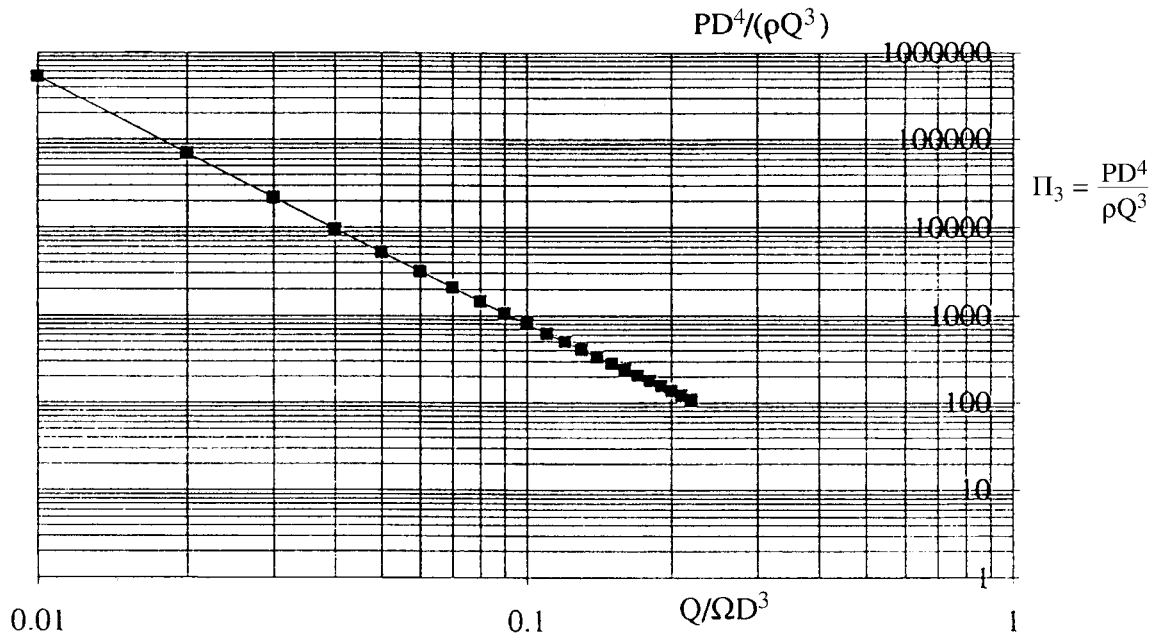


Fig. P5.87

Below  $\Pi_3 < 10,000$ , an excellent Power-law curve-fit is  $(Q/\Omega D^3) \approx 1.43/\Pi_3^{0.4} \pm 1\%$ . We use the given data to evaluate  $\Pi_3$  and hence compute  $Q/\Omega D^3$ :

$$\Pi_3 = \frac{(300)(0.12)^4}{(680)(25/3600)^3} = 273, \quad \text{whence} \quad \frac{Q}{\Omega D^3} \approx \frac{1.43}{(273)^{0.4}} \approx 0.152 = \frac{25/3600}{\Omega(0.12)^3}$$

Solve for  $\Omega \approx 26.5 \text{ rev/s}$  Ans.

**5.88** Modify Prob. 5.62 as follows: Let  $\Omega = 32 \text{ r/s}$  and  $Q = 24 \text{ m}^3/\text{h}$  for a geometrically similar pump. What is the maximum diameter if the power is not to exceed 340 W? Solve this problem by rescaling the data of Fig. P5.61 to make a plot of dimensionless power versus dimensionless diameter. Enter this plot directly to find the desired diameter.

**Solution:** We can eliminate  $D$  from the power coefficient for an alternate coefficient:

$$\Pi_4 = \frac{P}{\rho \Omega^3 D^5} \cdot \left( \frac{\Omega D^3}{Q} \right)^{5/3} = \frac{P}{\rho \Omega^{4/3} Q^{5/3}}, \quad \text{to be plotted versus} \quad \frac{Q}{\Omega D^3}$$

The plot is shown below, as computed from the expressions in Fig. P5.61.

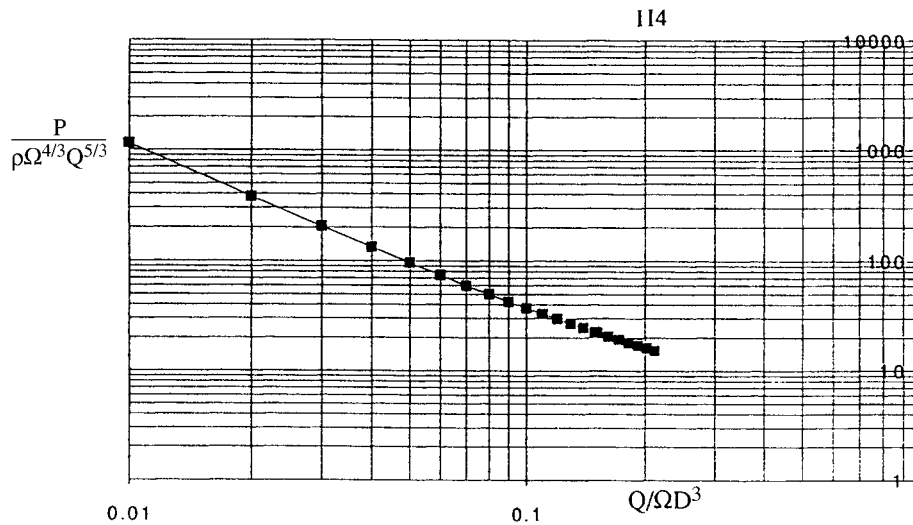


Fig. P5.88

Below  $\Pi_4 < 1,000$ , an excellent Power-law curve-fit is  $(Q/\Omega D^3) \approx 2.12/\Pi_4^{0.85} \pm 1\%$ . We use the given data to evaluate  $\Pi_4$  and hence compute  $Q/\Omega D^3$ :

$$\Pi_4 = \frac{340}{680(32)^{4/3}(24/3600)^{5/3}} = 20.8, \quad \text{whence} \quad \frac{Q}{\Omega D^3} = \frac{2.12}{(20.8)^{0.85}} \approx 0.161 = \frac{24/3600}{32D^3}$$

Solve for  $D \approx 0.109 \text{ m}$  Ans.

**5.89** Knowing that  $\Delta p$  is proportional to  $L$ , rescale the data of Example 5.7 to plot dimensionless  $\Delta p$  versus dimensionless *diameter*. Use this plot to find the diameter required in the first row of data in Example 5.7 if the pressure drop is increased to 10 kPa for the same flow rate, length, and fluid.

**Solution:** Recall that Example 5.7, where  $\Delta p/L = \text{fcn}(\rho, V, \mu, D)$ , led to the correlation

$$\frac{\rho D^3 \Delta p}{L \mu^2} \approx 0.155 \left( \frac{\rho V D}{\mu} \right)^{1.75}, \quad \text{which is awkward because } D \text{ occurs on both sides.}$$

Further, we need  $Q = (\pi/4)D^2V$ , not  $V$ , for the desired correlation, because  $Q$  is known. We form this by multiplying the equation by  $(\rho Q/D\mu)$  to get a new “ $\Delta p$  vs.  $D$ ” correlation:

$$\Pi_3 = \frac{\rho D^3 \Delta p}{L \mu^2} \left( \frac{\rho Q}{D \mu} \right)^3 = \frac{\rho^4 Q^3 \Delta p}{L \mu^5} \approx 0.155 \left( \frac{4 \rho Q}{\pi \mu D} \right)^{1.75} \left( \frac{\rho Q}{D \mu} \right)^3 \approx 0.236 \left( \frac{\rho Q}{D \mu} \right)^{4.75} \quad (2)$$

Correlation “2” can now be used to solve for an unknown diameter. The data are the first row of Example 5.7, with diameter unknown and a new pressure drop listed:

$$L = 5 \text{ m}; \quad Q = 0.3 \text{ m}^3/\text{hr}; \quad \Delta p = 10,000 \text{ Pa}; \quad \rho = 680 \text{ kg/m}^3; \quad \mu = 2.92\text{E-}4 \text{ kg/m}\cdot\text{s}$$

$$\text{Evaluate } \Pi_3 = \frac{(680)^4 (0.3/3600)^3 (10000)}{(5)(2.92\text{E-}4)^5} \approx 1.17\text{E}20 \approx 0.236(\rho Q/D\mu)^{4.75}$$

$$\text{Solve for } \frac{\rho Q}{D\mu} \approx 22700 = \frac{(680)(0.3/3600)}{D(2.92\text{E-}4)} \quad \text{or} \quad \mathbf{D \approx 0.0085 \text{ m}}$$

This solution is restricted to smooth walls, for which the data in Ex. 5.7 was taken.

---

**5.90** Knowing that  $\Delta p$  is proportional to  $L$ , rescale the data of Example 5.7 to plot dimensionless  $\Delta p$  versus dimensionless *viscosity*. Use this plot to find the viscosity required in the first row of data in Example 5.7 if the pressure drop is increased to 10 kPa for the same flow rate, length, and density.

**Solution:** Recall that Example 5.7, where  $\Delta p/L = \text{fcn}(\rho, V, \mu, D)$ , led to the correlation

$$\frac{\rho D^3 \Delta p}{L \mu^2} \approx 0.155 \left( \frac{\rho V D}{\mu} \right)^{1.75}, \quad \text{which is awkward because } \mu \text{ occurs on both sides.}$$

We can form a “ $\mu$ -free” parameter by dividing the left side by Reynolds-number-squared:

$$\Pi_4 = \frac{\rho D^3 \Delta p / L \mu^2}{(\rho V D / \mu)^2} = \frac{\Delta p D}{\rho V^2 L} \approx \frac{0.155}{(\rho V D / \mu)^{0.25}} \quad (3)$$

Correlation “3” can now be used to solve for an unknown viscosity. The data are the first row of Example 5.7, with viscosity unknown and a new pressure drop listed:

$$L = 5 \text{ m}; \quad D = 1 \text{ cm}; \quad Q = 0.3 \text{ m}^3/\text{hr}; \quad \Delta p = 10,000 \text{ Pa}; \quad \rho = 680 \frac{\text{kg}}{\text{m}^3}; \quad V = 1.06 \frac{\text{m}}{\text{s}}$$

$$\text{Evaluate } \Pi_4 = \frac{(10000)(0.01)}{(680)(1.06)^2 (5.0)} = 0.0262 \stackrel{?}{=} \frac{0.155}{\text{Re}^{0.25}}, \quad \text{or} \quad \text{Re} \approx 1230 \text{ ???}$$

This is a trap for the unwary:  $\text{Re} = 1230$  is **far below the range of the data** in Ex. 5.7, for which  $15000 < \text{Re} < 95000$ . The solution cannot be trusted and in fact is quite incorrect, for the flow would be laminar and follow an entirely different correlation. *Ans.*

---

**5.91** Develop a plot of dimensionless  $\Delta p$  versus dimensionless viscosity, as described in Prob. 5.90. Suppose that  $L = 200 \text{ m}$ ,  $Q = 60 \text{ m}^3/\text{h}$ , and the fluid is kerosene at  $20^\circ\text{C}$ . Use your plot to determine the minimum pipe diameter for which the pressure drop is no more than 220 kPa.

**Solution:** For kerosene at 20°C, take  $\rho = 804 \text{ kg/m}^3$  and  $\mu = 0.00192 \text{ kg/m}\cdot\text{s}$ . We have to convert correlation “3” in Prob. 5.90 to use the known  $Q$  instead of the unknown  $V$ . Substitute  $Q = (\pi/4)D^2V$  into both sides of the correlation:

$$\frac{\pi^2 \Delta p D^5}{16 \rho Q^2 L} \approx \frac{0.155}{(4 \rho Q / \pi \mu D)^{0.25}}, \quad \text{or:} \quad \frac{\pi^2 (220000) D^5}{16 (804) (60/3600)^2 (200)} \approx \frac{0.155 [\pi (0.00192) D]^{1/4}}{[4 (804) (60/3600)]^{1/4}}$$

$$\text{Solve for } D^{4.75} = 5.25\text{E-6}, \quad \text{or } \mathbf{D \approx 0.0774 \text{ m}} \quad \text{Ans.}$$

This looks OK, but check  $Re = 4\rho Q/(\pi\mu D) \approx 4(804)(60/3600)/[\pi(0.00192)(0.0774)] \approx \mathbf{115,000}$ —slightly to the right of the data in Eq. 5.7, Fig. 5.10. Extrapolation is somewhat risky but in this case gives the correct diameter, whereas the extrapolation in Prob. 5.90 was completely incorrect.

---

**FUNDAMENTALS OF ENGINEERING EXAM PROBLEMS: Answers**

FE5.1 Given the parameters ( $U$ ,  $L$ ,  $g$ ,  $\rho$ ,  $\mu$ ) which affect a certain liquid flow problem. The ratio  $V^2/(Lg)$  is usually known as the

(a) velocity head (b) Bernoulli head (c) **Froude No.** (d) kinetic energy (e) impact energy

FE5.2 A ship 150 m long, designed to cruise at 18 knots, is to be tested in a tow tank with a model 3 m long. The appropriate tow velocity is

(a) 0.19 m/s (b) 0.35 m/s (c) **1.31 m/s** (d) 2.55 m/s (e) 8.35 m/s

FE5.3 A ship 150 m long, designed to cruise at 18 knots, is to be tested in a tow tank with a model 3 m long. If the model wave drag is 2.2 N, the estimated full-size ship wave drag is

(a) 5500 N (b) 8700 N (c) 38900 N (d) 61800 N (e) **275000 N**

FE5.4 A tidal estuary is dominated by the semi-diurnal lunar tide, with a period of 12.42 hours. If a 1:500 model of the estuary is tested, what should be the model tidal period?

(a) 4.0 s (b) 1.5 min (c) 17 min (d) **33 min** (e) 64 min

FE5.5 A football, meant to be thrown at 60 mi/h in sea-level air ( $\rho = 1.22 \text{ kg/m}^3$ ,  $\mu = 1.78\text{E-}5 \text{ N}\cdot\text{s/m}^2$ ) is to be tested using a one-quarter scale model in a water tunnel ( $\rho = 998 \text{ kg/m}^3$ ,  $\mu = 0.0010 \text{ N}\cdot\text{s/m}^2$ ). For dynamic similarity, what is the proper model water velocity?

(a) 7.5 mi/hr (b) 15.0 mi/hr (c) 15.6 mi/hr (d) **16.5 mi/hr** (e) 30 mi/hr

FE5.6 A football, meant to be thrown at 60 mi/h in sea-level air ( $\rho = 1.22 \text{ kg/m}^3$ ,  $\mu = 1.78\text{E-}5 \text{ N}\cdot\text{s/m}^2$ ) is to be tested using a one-quarter scale model in a water tunnel ( $\rho = 998 \text{ kg/m}^3$ ,  $\mu = 0.0010 \text{ N}\cdot\text{s/m}^2$ ). For dynamic similarity, what is the ratio of model force to prototype force?

(a) **3.86:1** (b) 16:1 (c) 32:1 (d) 56.2:1 (e) 64:1

FE5.7 Consider liquid flow of density  $\rho$ , viscosity  $\mu$ , and velocity  $U$  over a very small model spillway of length scale  $L$ , such that the liquid surface tension coefficient  $Y$  is important. The quantity  $\rho U^2 L / Y$  in this case is important and is called the

(a) capillary rise (b) Froude No. (c) Prandtl No. (d) **Weber No.** (e) Bond No.

FE5.8 If a stream flowing at velocity  $U$  past a body of length  $L$  causes a force  $F$  on the body which depends only upon  $U$ ,  $L$  and fluid viscosity  $\mu$ , then  $F$  must be proportional to

(a)  $\rho UL / \mu$  (b)  $\rho U^2 L^2$  (c)  $\mu U / L$  (d)  **$\mu UL$**  (e)  $UL / \mu$

FE5.9 In supersonic wind tunnel testing, if different gases are used, dynamic similarity requires that the model and prototype have the same Mach number and the same

(a) Euler number (b) speed of sound (c) stagnation enthalpy  
(d) Froude number (e) **specific heat ratio**

FE5.10 The Reynolds number for a 1-ft-diameter sphere moving at 2.3 mi/hr through seawater (specific gravity 1.027, viscosity  $1.07\text{E-}3 \text{ N}\cdot\text{s/m}^2$ ) is approximately

(a) 300 (b) 3000 (c) 30,000 (d) **300,000** (e) 3,000,000

### COMPREHENSIVE PROBLEMS

**C5.1** Estimating pipe wall friction is one of the most common tasks in fluids engineering. For long circular, rough pipes in turbulent flow, wall shear  $\tau_w$  is a function of density  $\rho$ , viscosity  $\mu$ , average velocity  $V$ , pipe diameter  $d$ , and wall roughness height  $\varepsilon$ . Thus, functionally, we can write  $\tau_w = \text{fcn}(\rho, \mu, V, d, \varepsilon)$ . (a) Using dimensional analysis, rewrite this function in dimensionless form. (b) A certain pipe has  $d = 5$  cm and  $\varepsilon = 0.25$  mm. For flow of water at  $20^\circ\text{C}$ , measurements show the following values of wall shear stress:

Q (in gal/min)	~	1.5	3.0	6.0	9.0	12.0	14.0
$\tau_w$ (in Pa)	~	0.05	0.18	0.37	0.64	0.86	1.25

Plot this data in the dimensionless form suggested by your part (a) and suggest a curve-fit formula. Does your plot reveal the entire functional relation suggested in your part (a)?

**Solution:** (a) There are 6 variables and 3 primary dimensions, therefore we expect 3 Pi groups. The traditional choices are:

$$\frac{\tau_w}{\rho V^2} = \text{fcn}\left(\frac{\rho V d}{\mu}, \frac{\varepsilon}{d}\right) \quad \text{or:} \quad C_f = \text{fcn}\left(\text{Re}, \frac{\varepsilon}{d}\right) \quad \text{Ans. (a)}$$

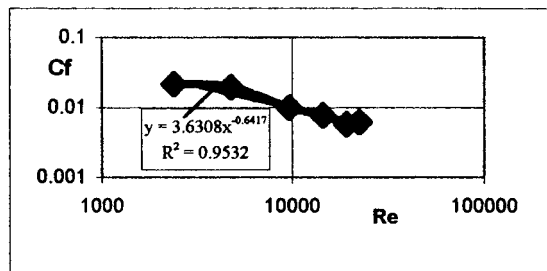
(b) In nondimensionalizing and plotting the above data, we find that  $\varepsilon/d = 0.25 \text{ mm}/50 \text{ mm} = 0.005$  for all the data. Therefore we only plot dimensionless shear versus Reynolds number, using  $\rho = 998 \text{ kg/m}^3$  and  $\mu = 0.001 \text{ kg/m}\cdot\text{s}$  for water. The results are tabulated as follows:

V, m/s	Re	Cf
0.0481972	2405	0.021567
0.0963944	4810	0.019411
0.1927888	9620	0.009975
0.2891832	14430	0.007668
0.3855776	19240	0.005796
0.4498406	22447	0.00619

When plotted on log-log paper,  $C_f$  versus Re makes a slightly curved line.

A reasonable power-law curve-fit is shown on the chart:  $C_f \approx 3.63\text{Re}^{-0.642}$  with 95% correlation. *Ans. (b)*

This curve is *only* for the narrow Reynolds number range 2000–22000 and a *single*  $\varepsilon/d$ .



**C5.2** When the fluid exiting a nozzle, as in Fig. P3.49, is a *gas*, instead of water, compressibility may be important, especially if upstream pressure  $p_1$  is large and exit diameter  $d_2$  is small. In this case, the difference  $(p_1 - p_2)$  is no longer controlling, and the gas mass flow,  $\dot{m}$ , reaches a maximum value which depends upon  $p_1$  and  $d_2$  and also upon the absolute upstream temperature,  $T_1$ , and the gas constant,  $R$ . Thus, functionally,  $\dot{m} = \text{fcn}(p_1, d_2, T_1, R)$ . (a) Using dimensional analysis, rewrite this function in dimensionless form. (b) A certain pipe has  $d_2 = 1$  mm. For flow of air, measurements show the following values of mass flow through the nozzle:

$T_1$ (in °K)	~	300	300	300	500	800
$p_1$ (in kPa)	~	200	250	300	300	300
$\dot{m}$ (in kg/s)	~	0.037	0.046	0.055	0.043	0.034

Plot this data in the dimensionless form suggested by your part (a). Does your plot reveal the entire functional relation suggested in your part (a)?

**Solution:** (a) There are  $n = 5$  variables and  $j = 4$  dimensions (M, L, T,  $\Theta$ ), hence we expect only  $n - j = 5 - 4 = 1$  Pi group, which turns out to be

$$\Pi_1 = \frac{\dot{m}\sqrt{RT_1}}{p_1 d_2^2} = \text{Constant} \quad \text{Ans. (a)}$$

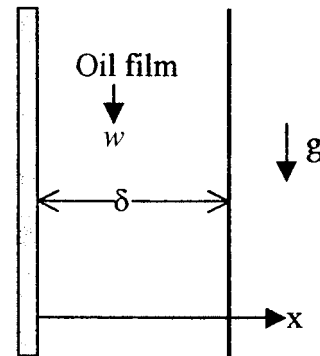
(b) The data should yield a *single* measured value of  $\Pi_1$  for all five points:

$T_1$ (in °K)	~	300	300	300	500	800
$\dot{m}\sqrt{(RT_1)}/(p_1 d_2^2)$ :		54.3	54.0	53.8	54.3	54.3

Thus the measured value of  $\Pi_1$  is about  $54.3 \pm 0.5$  (dimensionless). The problem asks you to *plot* this function, but since it is a *constant*, we shall not bother. *Ans. (a, b)*

PS: The correct value of  $\Pi_1$  (see Chap. 9) should be about **0.54**, not 54. Sorry: The nozzle diameter  $d_2$  was supposed to be **1 cm**, not 1 mm.

**C5.3** Reconsider the fully-developed draining vertical oil-film problem (see Fig. P4.80) as an exercise in dimensional analysis. Let the vertical velocity be a function only of distance from the plate, fluid properties, gravity, and film thickness. That is,  $w = \text{fcn}(x, \rho, \mu, g, \delta)$ . (a) Use the Pi theorem to rewrite this function in terms of dimensionless parameters. (b) Verify that the exact solution from Prob. 4.80 is consistent with your result in part (a).



**Solution:** There are  $n = 6$  variables and  $j = 3$  dimensions (M, L, T), hence we expect only  $n - j = 6 - 3 = 3$  Pi groups. The author selects  $(\rho, g, \delta)$  as repeating variables, whence

$$\Pi_1 = \frac{w}{\sqrt{g\delta}}; \quad \Pi_2 = \frac{\mu}{\rho\sqrt{g\delta^3}}; \quad \Pi_3 = \frac{x}{\delta}$$

Thus the expected function is

$$\frac{w}{\sqrt{g\delta}} = fcn\left(\frac{\mu}{\rho\sqrt{g\delta^3}}, \frac{x}{\delta}\right) \quad \text{Ans. (a)}$$

(b) The exact solution from Problem 4.80 can be written in just this form:

$$w = \frac{\rho g x}{2\mu}(x - 2\delta), \quad \text{or:} \quad \frac{w}{\sqrt{g\delta}} \frac{\mu}{\rho\sqrt{g\delta^3}} = \frac{1}{2} \frac{x}{\delta} \left(\frac{x}{\delta} - 2\right)$$

$\nearrow$   
 $\Pi_1$

$\nearrow$   
 $\Pi_2$

$\nearrow$   
 $\Pi_3$

Yes, the two forms of dimensionless function are the same. *Ans. (b)*

**C5.4** The Taco Inc. Model 4013 centrifugal pump has an impeller of diameter  $D = 12.95$  in. When pumping  $20^\circ\text{C}$  water at  $\Omega = 1160$  rev/min, the measured flow rate  $Q$  and pressure rise  $\Delta p$  are given by the manufacturer as follows:

$Q$ (gal/min)	~	200	300	400	500	600	700
$\Delta p$ (psi)	~	36	35	34	32	29	23

(a) Assuming that  $\Delta p = fcn(\rho, Q, D, \Omega)$ , use the Pi theorem to rewrite this function in terms of dimensionless parameters and then plot the given data in dimensionless form.

(b) It is desired to use the same pump, running at 900 rev/min, to pump  $20^\circ\text{C}$  gasoline at 400 gal/min. According to your dimensionless correlation, what pressure rise  $\Delta p$  is expected, in lbf/in<sup>2</sup>?

**Solution:** There are  $n = 5$  variables and  $j = 3$  dimensions (M, L, T), hence we expect  $n - j = 5 - 3 = 2$  Pi groups. The author selects  $(\rho, D, \Omega)$  as repeating variables, whence

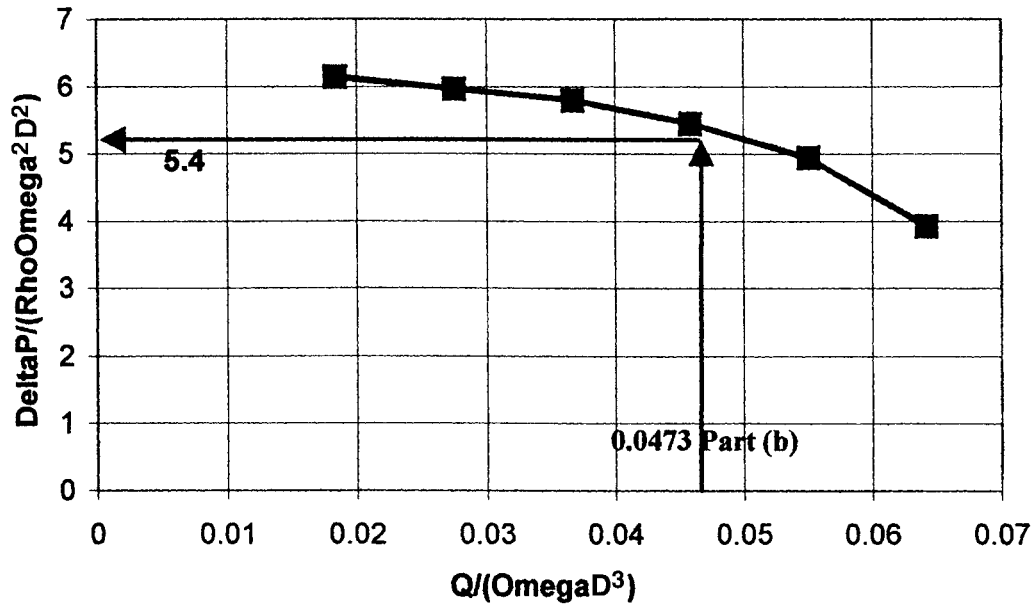
$$\Pi_1 = \frac{\Delta p}{\rho\Omega^2 D^2}; \quad \Pi_2 = \frac{Q}{\Omega D^3}, \quad \text{or:} \quad \frac{\Delta p}{\rho\Omega^2 D^2} = fcn\left(\frac{Q}{\Omega D^3}\right) \quad \text{Ans. (a)}$$



Convert the data to this form, using  $\Omega = 19.33 \text{ rev/s}$ ,  $D = 1.079 \text{ ft}$ ,  $\rho = 1.94 \text{ slug/ft}^3$ , and use  $\Delta p$  in  $\text{lb/ft}^2$ , not psi, and  $Q$  in  $\text{ft}^3/\text{s}$ , not gal/min:

$Q$ (gal/min)	~	200	300	400	500	600	700
$\Delta p/(\rho\Omega^2 D^2)$ :		6.14	5.97	5.80	5.46	4.95	3.92
$Q/(\Omega D^3)$ :		0.0183	0.0275	0.0367	0.0458	0.0550	0.0642

The dimensionless plot of  $\Pi_1$  versus  $\Pi_2$  is shown below.



(b) The dimensionless chart above is valid for the new conditions, also. Convert 400 gal/min to  $0.891 \text{ ft}^3/\text{s}$  and  $\Omega = 900 \text{ rev/min}$  to  $15 \text{ rev/s}$ . Then evaluate  $\Pi_2$ :

$$\Pi_2 = \frac{Q}{\Omega D^3} = \frac{0.891}{15(1.079)^3} = \mathbf{0.0473}$$

This value is entered in the chart above, from which we see that the corresponding value of  $\Pi_1$  is about **5.4**. For gasoline (Table A-3),  $\rho = 1.32 \text{ slug/ft}^3$ . Then this new running condition with gasoline corresponds to

$$\Pi_2 = 5.4 = \frac{\Delta p}{\rho\Omega^2 D^2} = \frac{\Delta p}{1.32(15)^2(1.079)^2}, \text{ solve for } \Delta p = 1870 \frac{\text{lb}}{\text{ft}^2} = \mathbf{13 \frac{\text{lb}}{\text{in}^2}} \text{ Ans. (b)}$$

**C5.5** Does an automobile radio antenna vibrate in resonance due to vortex shedding? Consider an antenna of length  $L$  and diameter  $D$ . According to beam-vibration theory [e.g. Kelly [34], p. 401], the first mode natural frequency of a solid circular cantilever beam is  $\omega_n = 3.516[EI/(\rho AL^4)]^{1/2}$ , where  $E$  is the modulus of elasticity,  $I$  is the area moment of inertia,  $\rho$  is the beam material density, and  $A$  is the beam cross-section area. (a) Show that  $\omega_n$  is proportional to the antenna radius  $R$ . (b) If the antenna is steel, with  $L = 60$  cm and  $D = 4$  mm, estimate the natural vibration frequency, in Hz. (c) Compare with the shedding frequency if the car moves at 65 mi/h.

**Solution:** (a) From Fig. 2.13 for a circular cross-section,  $A = \pi R^2$  and  $I = \pi R^4/4$ . Then the natural frequency is predicted to be:

$$\omega_n = 3.516 \sqrt{\frac{E\pi R^4/4}{\rho\pi R^2 L^4}} = \mathbf{1.758} \sqrt{\frac{E}{\rho}} \frac{R}{L^2} = \text{Const} \times RP \quad \text{Ans. (a)}$$

(b) For steel,  $E = 2.1\text{E}11$  Pa and  $\rho = 7840$  kg/m<sup>3</sup>. If  $L = 60$  cm and  $D = 4$  mm, then

$$\omega_n = 1.758 \sqrt{\frac{2.1\text{E}11}{7840}} \frac{0.002}{0.6^2} \approx 51 \frac{\text{rad}}{\text{s}} \approx \mathbf{8 \text{ Hz}} \quad \text{Ans. (b)}$$

(c) For  $U = 65$  mi/h = 29.1 m/s and sea-level air, check  $\text{Re}_D = \rho UD/\mu = 1.2(29.1)(0.004)/(0.000018) \approx 7800$ . From Fig. 5.2*b*, read Strouhal number  $\text{St} \approx 0.21$ . Then,

$$\frac{\omega_{shed} D}{2\pi U} = \frac{\omega_{shed}(0.004)}{2\pi(29.1)} \approx 0.21, \quad \text{or: } \omega_{shed} \approx 9600 \frac{\text{rad}}{\text{s}} \approx \mathbf{1500 \text{ Hz}} \quad \text{Ans. (c)}$$

Thus, for a typical antenna, the shedding frequency is far higher than the natural vibration frequency.

---

## Chapter 6 • Viscous Flow in Ducts

**6.1** In flow past a sphere, the boundary layer becomes turbulent at about  $Re_D \approx 2.5E5$ . To what air speed in mi/h does this correspond to a golf ball whose diameter is 1.6 in? Do the pressure, temperature, and humidity of the air make any difference in your calculation?

**Solution:** For air at 20°C, take  $\rho = 1.2 \text{ kg/m}^3$  and  $\mu = 1.8E-5 \text{ kg/m}\cdot\text{s}$ . Convert  $D = 1.6$  inches to 0.0406 m. The critical Reynolds number is

$$Re_D = 2.5E5 = \frac{\rho V D}{\mu} = \frac{1.2 V (0.0406)}{1.8E-5}, \quad \text{or} \quad V = 92 \frac{\text{m}}{\text{s}} \approx \mathbf{206 \frac{\text{mi}}{\text{h}}} \quad \text{Ans.}$$

Since air density and viscosity change with pressure, temperature, and humidity, the calculation does indeed depend upon the thermodynamic state of the air.

**6.2** Air at approximately 1 atm flows through a horizontal 4-cm-diameter pipe. (a) Find a formula for  $Q_{\max}$ , the maximum volume flow for which the flow remains laminar, and plot  $Q_{\max}$  versus temperature in the range  $0^\circ\text{C} \leq T \leq 500^\circ\text{C}$ . (b) Is your plot linear? If not, explain.

**Solution:** (a) First convert the Reynolds number from a velocity form to a volume flow form:

$$V = \frac{Q}{(\pi/4)d^2}, \quad \text{therefore} \quad Re_d = \frac{\rho V d}{\mu} = \frac{4\rho Q}{\pi\mu d} \leq 2300 \quad \text{for laminar flow}$$

$$\text{Maximum laminar volume flow is given by} \quad \mathbf{Q_{\max} = \frac{2300\pi d\mu}{4\rho}} \quad \text{Ans. (a)}$$

With  $d = 0.04 \text{ m} = \text{constant}$ , get  $\mu$  and  $\rho$  for air from Table A-2 and plot  $Q_{\max}$  versus  $T$  °C:

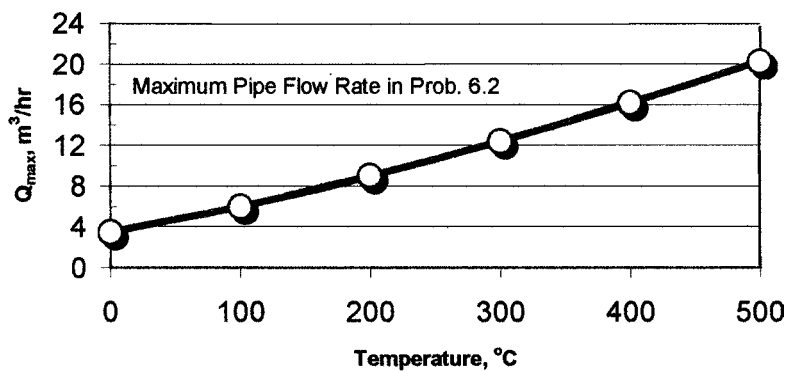


Fig. P6.2

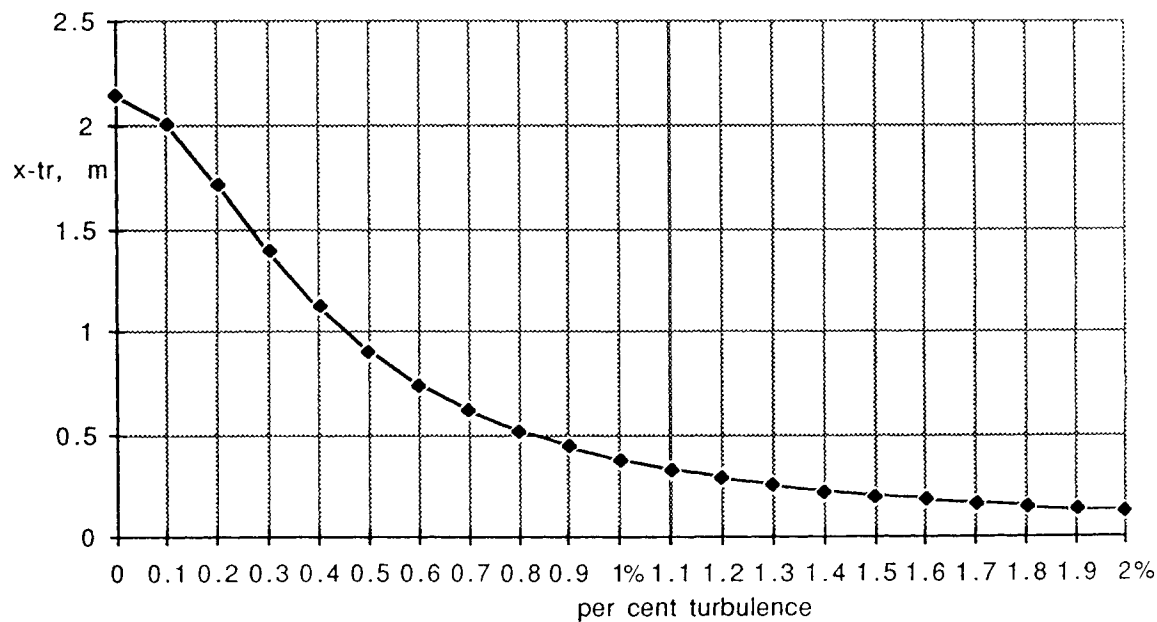
The curve is not quite linear because  $\nu = \mu/\rho$  is not quite linear with  $T$  for air in this range. *Ans.* (b)

**6.3** For a thin wing moving parallel to its chord line, transition to a turbulent boundary layer occurs at a “local” Reynolds number  $Re_x$ , where  $x$  is the distance from the leading edge of the wing. The critical Reynolds number depends upon the intensity of turbulent fluctuations in the stream and equals  $2.8E6$  if the stream is very quiet. A semiempirical correlation for this case [Ref. 3 of Ch. 6] is

$$Re_{x_{crit}}^{1/2} \approx \frac{-1 + (1 + 13.25\zeta^2)^{1/2}}{0.00392\zeta^2}$$

where  $\zeta$  is the tunnel-turbulence intensity in percent. If  $V = 20$  m/s in air at  $20^\circ\text{C}$ , use this formula to plot the transition position on the wing versus stream turbulence for  $\zeta$  between 0 and 2 percent. At what value of  $\zeta$  is  $x_{crit}$  decreased 50 percent from its value at  $\zeta = 0$ ?

**Solution:** This problem is merely to illustrate the *strong* effect of stream turbulence on the transition point. For air at  $20^\circ\text{C}$ , take  $\rho = 1.2$  kg/m<sup>3</sup> and  $\mu = 1.8E-5$  kg/m·s. Compute  $Re_{x_{crit}}$  from the correlation and plot  $x_{tr} = \mu Re_x / [\rho(20 \text{ m/s})]$  versus percent turbulence:



**Fig. P6.3**

The value of  $x_{crit}$  decreases by half (to 1.07 meters) at  $\zeta \approx 0.42\%$ . *Ans.*

**6.4** For flow of SAE 30 oil through a 5-cm-diameter pipe, from Fig. A.1, for what flow rate in  $\text{m}^3/\text{h}$  would we expect transition to turbulence at (a)  $20^\circ\text{C}$  and (b)  $100^\circ\text{C}$ ?

**Solution:** For SAE 30 oil take  $\rho = 891 \text{ kg/m}^3$  and take  $\mu = 0.29 \text{ kg/m}\cdot\text{s}$  at  $20^\circ\text{C}$  (Table A.3) and  $0.01 \text{ kg/m}\cdot\text{s}$  at  $100^\circ\text{C}$  (Fig A.1). Write the critical Reynolds number in terms of flow rate  $Q$ :

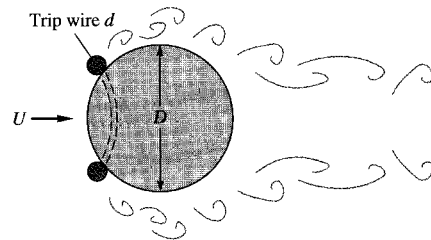
$$(a) \text{Re}_{crit} = 2300 = \frac{\rho V D}{\mu} = \frac{4\rho Q}{\pi\mu D} = \frac{4(891 \text{ kg/m}^3)Q}{\pi(0.29 \text{ kg/m}\cdot\text{s})(0.05 \text{ m})},$$

$$\text{solve } Q = 0.0293 \frac{\text{m}^3}{\text{s}} = \mathbf{106 \frac{\text{m}^3}{\text{h}}} \quad \text{Ans. (a)}$$

$$(b) \text{Re}_{crit} = 2300 = \frac{\rho V D}{\mu} = \frac{4\rho Q}{\pi\mu D} = \frac{4(891 \text{ kg/m}^3)Q}{\pi(0.010 \text{ kg/m}\cdot\text{s})(0.05 \text{ m})},$$

$$\text{solve } Q = 0.00101 \frac{\text{m}^3}{\text{s}} = \mathbf{3.6 \frac{\text{m}^3}{\text{h}}} \quad \text{Ans. (b)}$$

**6.5** In flow past a body or wall, early transition to turbulence can be induced by placing a trip wire on the wall across the flow, as in Fig. P6.5. If the trip wire in Fig. P6.5 is placed where the local velocity is  $U$ , it will trigger turbulence if  $Ud/\nu = 850$ , where  $d$  is the wire diameter [Ref. 3 of Ch. 6]. If the sphere diameter is 20 cm and transition is observed at  $\text{Re}_D = 90,000$ , what is the diameter of the trip wire in mm?



**Fig. P6.5**

**Solution:** For the same  $U$  and  $\nu$ ,

$$\text{Re}_d = \frac{Ud}{\nu} = 850; \quad \text{Re}_D = \frac{UD}{\nu} = 90000,$$

$$\text{or } d = D \frac{\text{Re}_d}{\text{Re}_D} = (200 \text{ mm}) \left( \frac{850}{90000} \right) \approx \mathbf{1.9 \text{ mm}}$$

**6.6** A fluid at  $20^\circ\text{C}$  flows at  $850 \text{ cm}^3/\text{s}$  through an 8-cm-diameter pipe. Determine the entrance length if the fluid is (a) hydrogen; (b) air; (c) gasoline; (d) water; (e) mercury; and (f) glycerin.

**Solution:** Tabulate the kinematic viscosities and compute  $\text{Re}_D = VD/\nu$ , where  $V = 4Q/(\pi D^2) = 4(850 \text{E-6 m}^3/\text{s})/[\pi(0.08 \text{ m})^2] = 0.169 \text{ m/s}$ . Thus  $\text{Re}_D = (0.169)(0.08)/\nu = 0.0135/\nu$ .

Depending upon whether the flow is laminar ( $Re_D < 2300$ ) or turbulent ( $Re_D > 2300$ ) use the formulas:

$$\text{Laminar: } \frac{L_{\text{entrance}}}{D} \approx 0.06Re_D; \quad \text{Turbulent: } \frac{L_{\text{entrance}}}{D} \approx 4.4Re_D^{1/6}$$

Fluid	$\nu, \text{m}^2/\text{s}$	$Re_D$	Type of flow	$L_{\text{entr}}/D$	Entrance Length
(a) Hydrogen	1.08E-4	125	Laminar	7.5	0.6 m
(b) Air	1.5E-5	900	Laminar	54.0	4.32 m
(c) Gasoline	4.3E-7	31400	Turbulent	24.7	1.98 m
(d) Water	1.0E-6	13500	Turbulent	21.5	1.72 m
(e) Mercury	1.15E-7	117000	Turbulent	30.8	2.46 m
(f) Glycerin	1.18E-3	11.4	Laminar	0.68	0.055 m

**6.7** Cola, approximated as pure water at 20°C, is to fill an 8-oz container (1 U.S. gal = 128 fl oz) through a 5-mm-diameter tube. Estimate the minimum filling time if the tube flow is to remain laminar. For what cola (water) temperature would this minimum time be 1 min?

**Solution:** For cola “water”, take  $\rho = 998 \text{ kg/m}^3$  and  $\mu = 0.001 \text{ kg/m}\cdot\text{s}$ . Convert 8 fluid ounces =  $(8/128)(231 \text{ in}^3) \approx 2.37\text{E}-4 \text{ m}^3$ . Then, if we assume transition at  $Re = 2300$ ,

$$Re_{\text{crit}} = 2300 = \frac{\rho VD}{\mu} = \frac{4\rho Q}{\pi\mu D}, \quad \text{or: } Q_{\text{crit}} = \frac{2300\pi(0.001)(0.005)}{4(998)} \approx 9.05\text{E}-6 \frac{\text{m}^3}{\text{s}}$$

$$\text{Then } \Delta t_{\text{fill}} = \nu/Q = 2.37\text{E}-4/9.05\text{E}-6 \approx \mathbf{26 \text{ s}} \quad \text{Ans. (a)}$$

(b) We fill in exactly one minute if  $Q_{\text{crit}} = 2.37\text{E}-4/60 = 3.94\text{E}-6 \text{ m}^3/\text{s}$ . Then

$$Q_{\text{crit}} = 3.94\text{E}-6 \frac{\text{m}^3}{\text{s}} = \frac{2300\pi\nu D}{4} \quad \text{if } \nu_{\text{water}} \approx 4.36\text{E}-7 \text{ m}^2/\text{s}$$

From Table A-1, this kinematic viscosity occurs at  $\mathbf{T \approx 66^\circ\text{C}}$  Ans. (b)

**6.8** When water at 20°C ( $\rho = 998 \text{ kg/m}^3$ ,  $\mu = 0.001 \text{ kg/m}\cdot\text{s}$ ) flows through an 8-cm-diameter pipe, the wall shear stress is 72 Pa. What is the axial pressure gradient ( $\partial p/\partial x$ ) if the pipe is (a) horizontal; and (b) vertical with the flow *up*?

**Solution:** Equation (6.9b) applies in both cases, noting that  $\tau_w$  is negative:

$$(a) \text{ Horizontal: } \frac{dp}{dx} = \frac{2\tau_w}{R} = \frac{2(-72 \text{ Pa})}{0.04 \text{ m}} = -3600 \frac{\text{Pa}}{\text{m}} \quad \text{Ans. (a)}$$

$$(b) \text{ Vertical, up: } \frac{dp}{dx} = \frac{2\tau_w}{R} - \rho g \frac{dz}{dx} = -3600 - 998(9.81) = -13,400 \frac{\text{Pa}}{\text{m}} \quad \text{Ans. (b)}$$

**6.9** A light liquid ( $\rho = 950 \text{ kg/m}^3$ ) flows at an average velocity of 10 m/s through a horizontal smooth tube of diameter 5 cm. The fluid pressure is measured at 1-m intervals along the pipe, as follows:

$x, \text{ m:}$	0	1	2	3	4	5	6
$p, \text{ kPa:}$	304	273	255	240	226	213	200

Estimate (a) the total head loss, in meters; (b) the wall shear stress in the fully developed section of the pipe; and (c) the overall friction factor.

**Solution:** As sketched in Fig. 6.6 of the text, the pressure drops fast in the entrance region (31 kPa in the first meter) and levels off to a linear decrease in the “fully developed” region (13 kPa/m for this data).

(a) The overall head loss, for  $\Delta z = 0$ , is defined by Eq. (6.8) of the text:

$$h_f = \frac{\Delta p}{\rho g} = \frac{304,000 - 200,000 \text{ Pa}}{(950 \text{ kg/m}^3)(9.81 \text{ m/s}^2)} = \mathbf{11.2 \text{ m}} \quad \text{Ans. (a)}$$

(b) The wall shear stress in the fully-developed region is defined by Eq. (6.9b):

$$\frac{\Delta p}{\Delta L} \Big|_{\text{fully developed}} = \frac{13000 \text{ Pa}}{1 \text{ m}} = \frac{4\tau_w}{d} = \frac{4\tau_w}{0.05 \text{ m}}, \quad \text{solve for } \tau_w = \mathbf{163 \text{ Pa}} \quad \text{Ans. (b)}$$

(c) The overall friction factor is defined by Eq. (6.10) of the text:

$$f_{\text{overall}} = h_{f, \text{overall}} \frac{d}{L} \frac{2g}{V^2} = (11.2 \text{ m}) \left( \frac{0.05 \text{ m}}{6 \text{ m}} \right) \frac{2(9.81 \text{ m/s}^2)}{(10 \text{ m/s})^2} = \mathbf{0.0182} \quad \text{Ans. (c)}$$

NOTE: The fully-developed friction factor is only 0.0137.

**6.10** Water at 20°C ( $\rho = 998 \text{ kg/m}^3$ ) flows through an inclined 8-cm-diameter pipe. At sections A and B,  $p_A = 186 \text{ kPa}$ ,  $V_A = 3.2 \text{ m/s}$ ,  $z_A = 24.5 \text{ m}$ , while  $p_B = 260 \text{ kPa}$ ,  $V_B = 3.2 \text{ m/s}$ , and  $z_B = 9.1 \text{ m}$ . Which way is the flow going? What is the head loss?

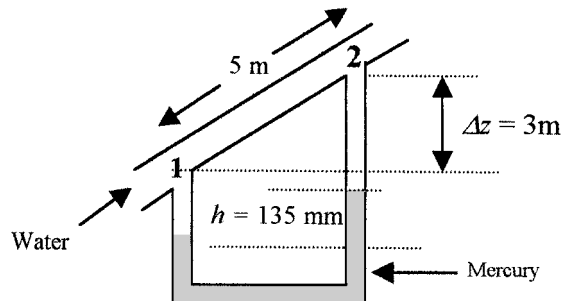
**Solution:** Guess that the flow is from A to B and write the steady flow energy equation:

$$\frac{p_A}{\rho g} + \frac{V_A^2}{2g} + z_A = \frac{p_B}{\rho g} + \frac{V_B^2}{2g} + z_B + h_f, \quad \text{or:} \quad \frac{186000}{9790} + 24.5 = \frac{260000}{9790} + 9.1 + h_f,$$

or:  $43.50 = 35.66 + h_f$ , solve:  $h_f = +7.84 \text{ m}$  Yes, flow is from A to B. Ans. (a, b)

**6.11** Water at 20°C flows upward at 4 m/s in a 6-cm-diameter pipe. The pipe length between points 1 and 2 is 5 m, and point 2 is 3 m higher. A mercury manometer, connected between 1 and 2, has a reading  $h = 135 \text{ mm}$ , with  $p_1$  higher. (a) What is the pressure change ( $p_1 - p_2$ )? (b) What is the head loss, in meters? (c) Is the manometer reading proportional to head loss? Explain. (d) What is the friction factor of the flow?

**Solution:** A sketch of this situation is shown at right. By moving through the manometer, we obtain the pressure change between points 1 and 2, which we compare with Eq. (6.9b):



$$p_1 + \gamma_w h - \gamma_m h - \gamma_w \Delta z = p_2,$$

$$\begin{aligned} \text{or: } p_1 - p_2 &= \left( 133100 - 9790 \frac{\text{N}}{\text{m}^3} \right) (0.135 \text{ m}) + \left( 9790 \frac{\text{N}}{\text{m}^3} \right) (3 \text{ m}) \\ &= 16650 + 29370 = \mathbf{46,000 \text{ Pa}} \quad \text{Ans. (a)} \end{aligned}$$

$$\text{From Eq. (6.9b), } h_f = \frac{\Delta p}{\gamma_w} - \Delta z = \frac{46000 \text{ Pa}}{9790 \text{ N/m}^3} - 3 \text{ m} = 4.7 - 3.0 = \mathbf{1.7 \text{ m}} \quad \text{Ans. (b)}$$

$$\text{The friction factor is } f = h_f \frac{d}{L} \frac{2g}{V^2} = (1.7 \text{ m}) \left( \frac{0.06 \text{ m}}{5 \text{ m}} \right) \frac{2(9.81 \text{ m/s}^2)}{(4 \text{ m/s})^2} = \mathbf{0.025} \quad \text{Ans. (d)}$$

By comparing the manometer relation to the head-loss relation above, we find that:

$$h_f = \frac{(\gamma_m - \gamma_w)}{\gamma_w} h \quad \text{and thus head loss is proportional to manometer reading.} \quad \text{Ans. (c)}$$



**NOTE: IN PROBLEMS 6.12 TO 6.99, MINOR LOSSES ARE NEGLECTED.**

**6.12** A 5-mm-diameter capillary tube is used as a viscometer for oils. When the flow rate is  $0.071 \text{ m}^3/\text{h}$ , the measured pressure drop per unit length is  $375 \text{ kPa/m}$ . Estimate the viscosity of the fluid. Is the flow laminar? Can you also estimate the density of the fluid?

**Solution:** Assume laminar flow and use the pressure drop formula (6.12):

$$\frac{\Delta p}{L} = \frac{8Q\mu}{\pi R^4}, \quad \text{or: } 375000 \frac{\text{Pa}}{\text{m}} = \frac{8(0.071/3600)\mu}{\pi(0.0025)^4}, \quad \text{solve } \mu \approx \mathbf{0.292} \frac{\text{kg}}{\text{m}\cdot\text{s}} \quad \text{Ans.}$$

$$\text{Guessing } \rho_{\text{oil}} \approx 900 \frac{\text{kg}}{\text{m}^3},$$

$$\text{check } \text{Re} = \frac{4\rho Q}{\pi\mu d} = \frac{4(900)(0.071/3600)}{\pi(0.292)(0.005)} \approx \mathbf{16} \quad \text{OK, laminar} \quad \text{Ans.}$$

It is not possible to find density from this data, laminar pipe flow is independent of density.

**6.13** A soda straw is 20 cm long and 2 mm in diameter. It delivers cold cola, approximated as water at  $10^\circ\text{C}$ , at a rate of  $3 \text{ cm}^3/\text{s}$ . (a) What is the head loss through the straw? What is the axial pressure gradient  $\partial p/\partial x$  if the flow is (b) vertically up or (c) horizontal? Can the human lung deliver this much flow?

**Solution:** For water at  $10^\circ\text{C}$ , take  $\rho = 1000 \text{ kg/m}^3$  and  $\mu = 1.307\text{E}-3 \text{ kg/m}\cdot\text{s}$ . Check Re:

$$\text{Re} = \frac{4\rho Q}{\pi\mu d} = \frac{4(1000)(3\text{E}-6 \text{ m}^3/\text{s})}{\pi(1.307\text{E}-3)(0.002)} = 1460 \quad (\text{OK, laminar flow})$$

$$\text{Then, from Eq. (6.12), } h_f = \frac{128\mu L Q}{\pi\rho g d^4} = \frac{128(1.307\text{E}-3)(0.2)(3\text{E}-6)}{\pi(1000)(9.81)(0.002)^4} \approx \mathbf{0.204 \text{ m}} \quad \text{Ans. (a)}$$

If the straw is *horizontal*, then the pressure gradient is simply due to the head loss:

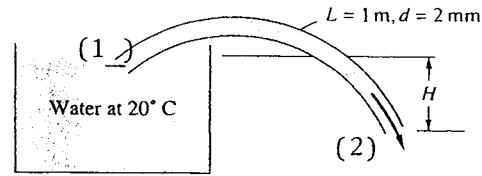
$$\frac{\Delta p}{L} \Big|_{\text{horiz}} = \frac{\rho g h_f}{L} = \frac{1000(9.81)(0.204 \text{ m})}{0.2 \text{ m}} \approx \mathbf{9980} \frac{\text{Pa}}{\text{m}} \quad \text{Ans. (c)}$$

If the straw is *vertical*, with flow *up*, the head loss and elevation change add together:

$$\frac{\Delta p}{L} \Big|_{\text{vertical}} = \frac{\rho g(h_f + \Delta z)}{L} = \frac{1000(9.81)(0.204 + 0.2)}{0.2} \approx \mathbf{19800} \frac{\text{Pa}}{\text{m}} \quad \text{Ans. (b)}$$

The human lung can certainly deliver case (c) and strong lungs can develop case (b) also.

**6.14** Water at 20°C is to be siphoned through a tube 1 m long and 2 mm in diameter, as in Fig. P6.14. Is there any height  $H$  for which the flow might not be laminar? What is the flow rate if  $H = 50$  cm? Neglect the tube curvature.



**Fig. P6.14**

**Solution:** For water at 20°C, take  $\rho = 998 \text{ kg/m}^3$  and  $\mu = 0.001 \text{ kg/m}\cdot\text{s}$ . Write the steady flow energy equation between points 1 and 2 above:

$$\frac{p_{\text{atm}}}{\rho g} + \frac{0^2}{2g} + z_1 = \frac{p_{\text{atm}}}{\rho g} + \frac{V_{\text{tube}}^2}{2g} + z_2 + h_f, \quad \text{or:} \quad H - \frac{V^2}{2g} = h_f = \frac{32\mu L}{\rho g d^2} V \quad (1)$$

$$\text{Enter data in Eq. (1):} \quad 0.5 - \frac{V^2}{2(9.81)} = \frac{32(0.001)(1.0)V}{(998)(9.81)(0.002)^2}, \quad \text{solve } V \approx 0.590 \frac{\text{m}}{\text{s}}$$

Equation (1) is quadratic in  $V$  and has only one positive root. The siphon flow rate is

$$Q_{H=50 \text{ cm}} = \frac{\pi}{4} (0.002)^2 (0.590) = 1.85\text{E-}6 \frac{\text{m}^3}{\text{s}} \approx \mathbf{0.0067 \frac{\text{m}^3}{\text{h}}} \quad \text{if } H = 50 \text{ cm} \quad \text{Ans.}$$

$$\text{Check } Re = (998)(0.590)(0.002)/(0.001) \approx 1180 \text{ (OK, laminar flow)}$$

It is possible to approach  $Re \approx 2000$  (possible transition to turbulent flow) for  $H < 1$  m, for the case of the siphon bent over nearly vertical. We obtain  **$Re = 2000$  at  $H \approx 0.87$  m.**

**6.15** Professor Gordon Holloway and his students at the University of New Brunswick went to a fast-food emporium and tried to drink chocolate shakes ( $\rho \approx 1200 \text{ kg/m}^3$ ,  $\mu \approx 6 \text{ kg/m}\cdot\text{s}$ ) through fat straws 8 mm in diameter and 30 cm long. (a) Verify that their human lungs, which can develop approximately 3000 Pa of vacuum pressure, would be unable to drink the milkshake through the vertical straw. (b) A student cut 15 cm from his straw and proceeded to drink happily. What rate of milkshake flow was produced by this strategy?

**Solution:** (a) Assume the straw is barely inserted into the milkshake. Then the energy equation predicts

$$\begin{aligned} \frac{p_1}{\rho g} + \frac{V_1^2}{2g} + z_1 &= \frac{p_2}{\rho g} + \frac{V_2^2}{2g} + z_2 + h_f \\ &= 0 + 0 + 0 = \frac{(-3000 \text{ Pa})}{(1200 \text{ kg/m}^3)(9.81 \text{ m/s}^2)} + \frac{V_{\text{tube}}^2}{2g} + 0.3 \text{ m} + h_f \end{aligned}$$

$$\text{Solve for } h_f = \mathbf{0.255 \text{ m} - 0.3 \text{ m} - \frac{V_{\text{tube}}^2}{2g} < 0} \quad \text{which is impossible} \quad \text{Ans. (a)}$$

(b) By cutting off 15 cm of vertical length and assuming laminar flow, we obtain a new energy equation

$$h_f = 0.255 - 0.15 - \frac{V^2}{2g} = \frac{32\mu LV}{\rho g d^2} = 0.105 m - \frac{V^2}{2(9.81)} = \frac{32(6.0)(0.15)V}{(1200)(9.81)(0.008)^2} = 38.23V$$

$$\text{Solve for } V = 0.00275 \text{ m/s, } Q = AV = (\pi/4)(0.008)^2(0.00275)$$

$$Q = 1.4E-7 \frac{\text{m}^3}{\text{s}} = \mathbf{0.14 \frac{\text{cm}^3}{\text{s}}} \quad \text{Ans. (b)}$$

Check the Reynolds number:  $Re_d = \rho V d / \mu = (1200)(0.00275)(0.008)/(6) = 0.0044$  (Laminar).

**6.16** Glycerin at 20°C is to be pumped through a horizontal smooth pipe at 3.1 m<sup>3</sup>/s. It is desired that (1) the flow be laminar and (2) the pressure drop be no more than 100 Pa/m. What is the minimum pipe diameter allowable?

**Solution:** For glycerin at 20°C, take  $\rho = 1260 \text{ kg/m}^3$  and  $\mu = 1.49 \text{ kg/m}\cdot\text{s}$ . We have two different constraints to satisfy, a pressure drop and a Reynolds number:

$$\frac{\Delta p}{L} = \frac{128\mu Q}{\pi d^4} \leq 100 \frac{\text{Pa}}{\text{m}} \quad (1); \quad \frac{128(1.49)(3.1)}{\pi d^4} \leq 100, \quad \mathbf{d \geq 1.17 \text{ m,}}$$

$$\text{or: } Re = \frac{4\rho Q}{\pi\mu d} \leq 2000 \quad (2); \quad \frac{4(1260)(3.1)}{\pi(1.49)d} \leq 2000, \quad \mathbf{d \geq 1.67 \text{ m}}$$

The first of these is more restrictive. Thus the proper diameter is  $\mathbf{d \geq 1.17 \text{ m}}$ . *Ans.*

**6.17** A capillary viscometer measures the time required for a specified volume  $v$  of liquid to flow through a small-bore glass tube, as in Fig. P6.17. This transit time is then correlated with fluid viscosity. For the system shown, (a) derive an approximate formula for the time required, assuming laminar flow with no entrance and exit losses. (b) If  $L = 12 \text{ cm}$ ,  $l = 2 \text{ cm}$ ,  $v = 8 \text{ cm}^3$ , and the fluid is water at 20°C, what capillary diameter  $D$  will result in a transit time  $t$  of 6 seconds?

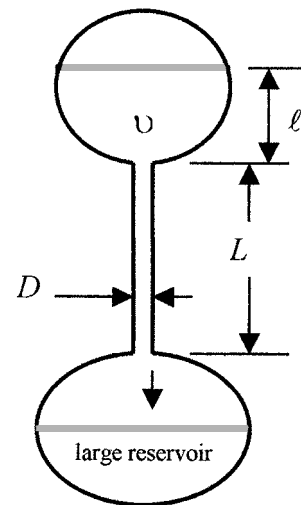


Fig. P6.17

**Solution:** (a) Assume no pressure drop and neglect velocity heads. The energy equation reduces to:

$$\frac{p_1}{\rho g} + \frac{V_1^2}{2g} + z_1 = 0 + 0 + (L+l) = \frac{p_2}{\rho g} + \frac{V_2^2}{2g} + z_2 + h_f = 0 + 0 + 0 + h_f, \quad \text{or: } h_f \approx L+l$$

$$\text{For laminar flow, } h_f = \frac{128\mu LQ}{\pi\rho g d^4} \quad \text{and, for uniform draining, } Q = \frac{v}{\Delta t}$$

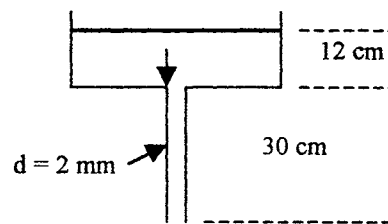
$$\text{Solve for } \Delta t = \frac{128\mu Lv}{\pi\rho g d^4(L+l)} \quad \text{Ans. (a)}$$

(b) Apply to  $\Delta t = 6$  s. For water, take  $\rho = 998$  kg/m<sup>3</sup> and  $\mu = 0.001$  kg/m·s. Formula (a) predicts:

$$\Delta t = 6 \text{ s} = \frac{128(0.001 \text{ kg/m}\cdot\text{s})(0.12 \text{ m})(8E-6 \text{ m}^3)}{\pi(998 \text{ kg/m}^3)(9.81 \text{ m/s}^2)d^4(0.12 + 0.02 \text{ m})}$$

$$\text{Solve for } d \approx \mathbf{0.0015 \text{ m}} \quad \text{Ans. (b)}$$

**6.18** To determine the viscosity of a liquid of specific gravity 0.95, you fill, to a depth of 12 cm, a large container which drains through a 30-cm-long vertical tube attached to the bottom. The tube diameter is 2 mm, and the rate of draining is found to be 1.9 cm<sup>3</sup>/s. What is your estimate of the fluid viscosity? Is the tube flow laminar?



**Fig. P6.18**

**Solution:** The known flow rate and diameter enable us to find the velocity in the tube:

$$V = \frac{Q}{A} = \frac{1.9E-6 \text{ m}^3/\text{s}}{(\pi/4)(0.002 \text{ m})^2} = 0.605 \frac{\text{m}}{\text{s}}$$

Evaluate  $\rho_{\text{liquid}} = 0.95(998) = 948$  kg/m<sup>3</sup>. Write the energy equation between the top surface and the tube exit:

$$\frac{p_a}{\rho g} + \frac{V_{\text{top}}^2}{2g} + z_{\text{top}} = \frac{p_a}{\rho g} + \frac{V^2}{2g} + 0 + h_f,$$

$$\text{or: } 0.42 = \frac{V^2}{2g} + \frac{32\mu LV}{\rho g d^4} = \frac{(0.605)^2}{2(9.81)} + \frac{32\mu(0.3)(0.605)}{948(9.81)(0.002)^4}$$

Note that “L” in this expression is the tube length only ( $L = 30$  cm).

$$\text{Solve for } \mu = \mathbf{0.00257} \frac{\text{kg}}{\text{m}\cdot\text{s}} \text{ (laminar flow) } \text{ Ans.}$$

$$Re_d = \frac{\rho V d}{\mu} = \frac{948(0.605)(0.002)}{0.00257} = 446 \text{ (laminar)}$$

**6.19** An oil ( $SG = 0.9$ ) issues from the pipe in Fig. P6.19 at  $Q = 35$  ft<sup>3</sup>/h. What is the kinematic viscosity of the oil in ft<sup>2</sup>/s? Is the flow laminar?

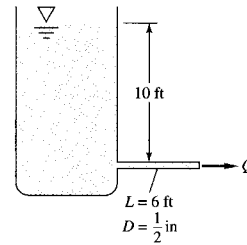


Fig. P6.19

**Solution:** Apply steady-flow energy:

$$\frac{p_{\text{atm}}}{\rho g} + \frac{0^2}{2g} + z_1 = \frac{p_{\text{atm}}}{\rho g} + \frac{V_2^2}{2g} + z_2 + h_f,$$

$$\text{where } V_2 = \frac{Q}{A} = \frac{35/3600}{\pi(0.25/12)^2} \approx 7.13 \frac{\text{ft}}{\text{s}}$$

$$\text{Solve } h_f = z_1 - z_2 - \frac{V_2^2}{2g} = 10 - \frac{(7.13)^2}{2(32.2)} = 9.21 \text{ ft}$$

Assuming laminar pipe flow, use Eq. (6.12) to relate head loss to viscosity:

$$h_f = 9.21 \text{ ft} = \frac{128\nu L Q}{\pi g d^4} = \frac{128(6)(35/3600)\nu}{\pi(32.2)(0.5/12)^4}, \text{ solve } \nu = \frac{\mu}{\rho} \approx \mathbf{3.76E-4} \frac{\text{ft}^2}{\text{s}} \text{ Ans.}$$

$$\text{Check } Re = 4Q/(\pi\nu d) = 4(35/3600)/[\pi(3.76E-4)(0.5/12)] \approx 790 \text{ (OK, laminar)}$$

**6.20** In Prob. 6.19 what will the flow rate be, in m<sup>3</sup>/h, if the fluid is SAE 10 oil at 20°C?

**Solution:** For SAE 10 oil at 20°C, take  $\rho = 1.69$  slug/ft<sup>3</sup> and  $\mu = 2.17E-3$  slug/ft·s. The steady flow energy analysis above gives, for laminar flow,

$$h_f = 10 - \frac{V^2}{2(32.2)} = \frac{32\mu L V}{\rho g d^2} = \frac{32(2.17E-3)(6.0)V}{(1.69)(32.2)(0.5/12)^2} = 4.41V \text{ (quadratic equation)}$$

$$\text{Solve for } V \approx 2.25 \frac{\text{ft}}{\text{s}}, \quad Q = \frac{\pi}{4} \left( \frac{0.5}{12} \right)^2 (2.25) = 0.00307 \frac{\text{ft}^3}{\text{s}} \approx \mathbf{0.31} \frac{\text{m}^3}{\text{h}} \text{ Ans.}$$

**6.21** In Tinyland, houses are less than a foot high! The rainfall is laminar! The drainpipe in Fig. P6.21 is only 2 mm in diameter. (a) When the gutter is full, what is the rate of draining? (b) The gutter is designed for a sudden rainstorm of up to 5 mm per hour. For this condition, what is the maximum roof area that can be drained successfully? (c) What is  $Re_d$ ?

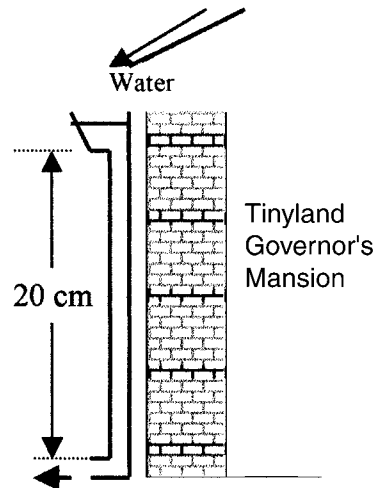


Fig. P6.21

**Solution:** If the velocity at the gutter surface is neglected, the energy equation reduces to

$$\Delta z = \frac{V^2}{2g} + h_f, \quad \text{where } h_{f,\text{laminar}} = \frac{32\mu LV}{\rho g d^2}$$

For water, take  $\rho = 998 \text{ kg/m}^3$  and  $\mu = 0.001 \text{ kg/m}\cdot\text{s}$ . (a) With  $\Delta z$  known, this is a quadratic equation for the pipe velocity  $V$ :

$$0.2 \text{ m} = \frac{V^2}{2(9.81 \text{ m/s}^2)} + \frac{32(0.001 \text{ kg/m}\cdot\text{s})(0.2 \text{ m})V}{(998 \text{ kg/m}^3)(9.81 \text{ m/s}^2)(0.002 \text{ m})^2},$$

$$\text{or: } 0.051V^2 + 0.1634V - 0.2 = 0, \quad \text{Solve for } V = 0.945 \frac{\text{m}}{\text{s}},$$

$$Q = \frac{\pi}{4}(0.002 \text{ m})^2 \left( 0.945 \frac{\text{m}}{\text{s}} \right) = 2.97E-6 \frac{\text{m}^3}{\text{s}} = \mathbf{0.0107 \frac{\text{m}^3}{\text{h}}} \quad \text{Ans. (a)}$$

(b) The roof area needed for maximum rainfall is  $0.0107 \text{ m}^3/\text{h} \div 0.005 \text{ m/h} = \mathbf{2.14 \text{ m}^2}$ . Ans. (b)

(c) The Reynolds number of the gutter is  $Re_d = (998)(0.945)(0.002)/(0.001) = \mathbf{1890}$  laminar. Ans. (c)

**6.22** A steady push on the piston in Fig. P6.22 causes a flow rate  $Q = 0.15 \text{ cm}^3/\text{s}$  through the needle. The fluid has  $\rho = 900 \text{ kg/m}^3$  and  $\mu = 0.002 \text{ kg/(m}\cdot\text{s)}$ . What force  $F$  is required to maintain the flow?

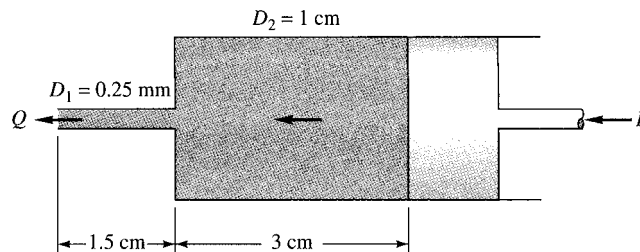


Fig. P6.22

**Solution:** Determine the velocity of exit from the needle and then apply the steady-flow energy equation:

$$V_1 = \frac{Q}{A} = \frac{0.15}{(\pi/4)(0.025)^2} = 306 \text{ cm/s}$$

$$\text{Energy: } \frac{p_2}{\rho g} + \frac{V_2^2}{2g} + z_2 = \frac{p_1}{\rho g} + \frac{V_1^2}{2g} + z_1 + h_{f1} + h_{f2}, \quad \text{with } z_1 = z_2, V_2 \approx 0, h_{f2} \approx 0$$

Assume laminar flow for the head loss and compute the pressure difference on the piston:

$$\frac{p_2 - p_1}{\rho g} = h_{f1} + \frac{V_1^2}{2g} = \frac{32(0.002)(0.015)(3.06)}{(900)(9.81)(0.00025)^2} + \frac{(3.06)^2}{2(9.81)} \approx 5.79 \text{ m}$$

$$\text{Then } F = \Delta p A_{\text{piston}} = (900)(9.81)(5.79) \frac{\pi}{4} (0.01)^2 \approx \mathbf{4.0 \text{ N}} \quad \text{Ans.}$$

**6.23** SAE 10 oil at 20°C flows in a vertical pipe of diameter 2.5 cm. It is found that the pressure is constant throughout the fluid. What is the oil flow rate in m<sup>3</sup>/h? Is the flow up or down?

**Solution:** For SAE 10 oil, take  $\rho = 870 \text{ kg/m}^3$  and  $\mu = 0.104 \text{ kg/m}\cdot\text{s}$ . Write the energy equation between point 1 upstream and point 2 downstream:

$$\frac{p_1}{\rho g} + \frac{V_1^2}{2g} + z_1 = \frac{p_2}{\rho g} + \frac{V_2^2}{2g} + z_2 + h_f, \quad \text{with } p_1 = p_2 \text{ and } V_1 = V_2$$

Thus  $h_f = z_1 - z_2 > 0$  by definition. Therefore, **flow is down.** *Ans.*

While flowing down, the pressure drop due to friction exactly balances the pressure rise due to gravity. Assuming laminar flow and noting that  $\Delta z = L$ , the pipe length, we get

$$h_f = \frac{128\mu L Q}{\pi \rho g d^4} = \Delta z = L,$$

$$\text{or: } Q = \frac{\pi(8.70)(9.81)(0.025)^4}{128(0.104)} = 7.87\text{E-}4 \frac{\text{m}^3}{\text{s}} = \mathbf{2.83 \frac{\text{m}^3}{\text{h}}} \quad \text{Ans.}$$

**6.24** Two tanks of water at 20°C are connected by a capillary tube 4 mm in diameter and 3.5 m long. The surface of tank 1 is 30 cm higher than the surface of tank 2. (a) Estimate the flow rate in m<sup>3</sup>/h. Is the flow laminar? (b) For what tube diameter will  $Re_d$  be 500?

**Solution:** For water, take  $\rho = 998 \text{ kg/m}^3$  and  $\mu = 0.001 \text{ kg/m}\cdot\text{s}$ . (a) Both tank surfaces are at atmospheric pressure and have negligible velocity. The energy equation, when neglecting minor losses, reduces to:

$$\Delta z = 0.3 \text{ m} = h_f = \frac{128\mu L Q}{\pi \rho g d^4} = \frac{128(0.001 \text{ kg/m}\cdot\text{s})(3.5 \text{ m})Q}{\pi(998 \text{ kg/m}^3)(9.81 \text{ m/s}^2)(0.004 \text{ m})^4}$$

$$\text{Solve for } Q = 5.3\text{E-}6 \frac{\text{m}^3}{\text{s}} = \mathbf{0.019 \frac{\text{m}^3}{\text{h}}} \quad \text{Ans. (a)}$$

$$\text{Check } \text{Re}_d = 4\rho Q/(\pi\mu d) = 4(998)(5.3\text{E-}6)/[\pi(0.001)(0.004)]$$

$$\mathbf{\text{Re}_d = 1675 \text{ laminar.}} \quad \text{Ans. (a)}$$

(b) If  $\text{Re}_d = 500 = 4\rho Q/(\pi\mu d)$  and  $\Delta z = h_f$ , we can solve for both  $Q$  and  $d$ :

$$\text{Re}_d = 500 = \frac{4(998 \text{ kg/m}^3)Q}{\pi(0.001 \text{ kg/m}\cdot\text{s})d}, \quad \text{or } Q = 0.000394d$$

$$h_f = 0.3 \text{ m} = \frac{128(0.001 \text{ kg/m}\cdot\text{s})(3.5 \text{ m})Q}{\pi(998 \text{ kg/m}^3)(9.81 \text{ m/s}^2)d^4}, \quad \text{or } Q = 20600d^4$$

$$\text{Combine these two to solve for } Q = 1.05\text{E-}6 \text{ m}^3/\text{s} \quad \text{and} \quad \mathbf{d = 2.67 \text{ mm}} \quad \text{Ans. (b)}$$

**6.25** For the configuration shown in Fig. P6.25, the fluid is ethyl alcohol at  $20^\circ\text{C}$ , and the tanks are very wide. Find the flow rate which occurs in  $\text{m}^3/\text{h}$ . Is the flow laminar?

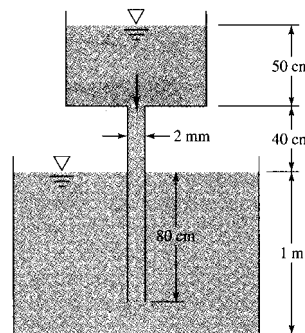
**Solution:** For ethanol, take  $\rho = 789 \text{ kg/m}^3$  and  $\mu = 0.0012 \text{ kg/m}\cdot\text{s}$ . Write the energy equation from upper free surface (1) to lower free surface (2):

$$\frac{p_1}{\rho g} + \frac{V_1^2}{2g} + z_1 = \frac{p_2}{\rho g} + \frac{V_2^2}{2g} + z_2 + h_f, \quad \text{with } p_1 = p_2 \text{ and } V_1 \approx V_2 \approx 0$$

$$\text{Then } h_f = z_1 - z_2 = 0.9 \text{ m} = \frac{128\mu L Q}{\pi \rho g d^4} = \frac{128(0.0012)(1.2 \text{ m})Q}{\pi(789)(9.81)(0.002)^4}$$

$$\text{Solve for } Q \approx 1.90\text{E-}6 \text{ m}^3/\text{s} = \mathbf{0.00684 \text{ m}^3/\text{h.}} \quad \text{Ans.}$$

Check the Reynolds number  $\text{Re} = 4\rho Q/(\pi\mu d) \approx 795$  – **OK, laminar flow.**



**Fig. P6.25**



**6.26** For the system in Fig. P6.25, if the fluid has density of  $920 \text{ kg/m}^3$  and the flow rate is unknown, for what value of viscosity will the capillary Reynolds number exactly equal the critical value of 2300?

**Solution:** Add to the energy analysis of Prob. 6.25 above that the Reynolds number must equal 2300:

$$h_f = 0.9 \text{ m} = \frac{128\mu L}{\pi\rho g d^4} Q = \frac{128\mu(1.2)}{\pi(920)(9.81)(0.002)^4} \left[ \frac{2300\pi\mu(0.002)}{4(920)} \right]$$

Solve for  $\mu = \mathbf{0.000823 \text{ kg/m}\cdot\text{s}}$  Ans.

**6.27** Let us attack Prob. 6.25 in symbolic fashion, using Fig. P6.27. All parameters are constant except the upper tank depth  $Z(t)$ . Find an expression for the flow rate  $Q(t)$  as a function of  $Z(t)$ . Set up a differential equation, and solve for the time  $t_0$  to drain the upper tank completely. Assume quasi-steady laminar flow.

**Solution:** The energy equation of Prob. 6.25, using symbols only, is combined with a control-volume mass balance for the tank to give the basic differential equation for  $Z(t)$ :

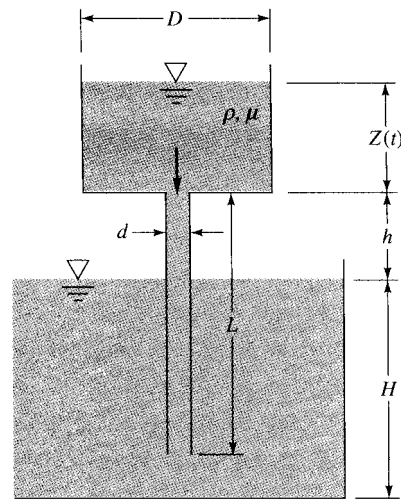


Fig. P6.27

$$\text{energy: } h_f = \frac{32\mu L V}{\rho g d^2} = h + Z; \quad \text{mass balance: } \frac{d}{dt} \left[ \frac{\pi}{4} D^2 Z + \frac{\pi}{4} d^2 L \right] = -Q = -\frac{\pi}{4} d^2 V,$$

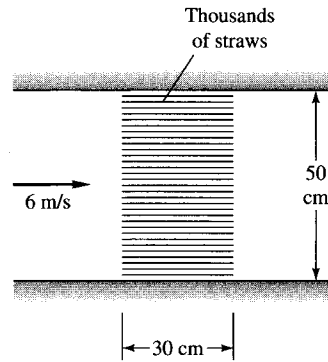
$$\text{or: } \frac{\pi}{4} D^2 \frac{dZ}{dt} = -\frac{\pi}{4} d^2 V, \quad \text{where } V = \frac{\rho g d^2}{32\mu L} (h + Z)$$

Separate the variables and integrate, combining all the constants into a single "C":

$$\int_{Z_0}^Z \frac{dZ}{h + Z} = -C \int_0^t dt, \quad \text{or: } Z = (h + Z_0) e^{-Ct} - h, \quad \text{where } C = \frac{\rho g d^4}{32\mu L D^2} \quad \text{Ans.}$$

$$\text{Tank drains completely when } Z = 0, \text{ at } t_0 = \frac{1}{C} \ln \left( 1 + \frac{Z_0}{h} \right) \quad \text{Ans.}$$

**6.28** For straightening and smoothing an airflow in a 50-cm-diameter duct, the duct is packed with a “honeycomb” of thin straws of length 30 cm and diameter 4 mm, as in Fig. P6.28. The inlet flow is air at 110 kPa and 20°C, moving at an average velocity of 6 m/s. Estimate the pressure drop across the honeycomb.



**Fig. P6.28**

**Solution:** For air at 20°C, take  $\mu \approx 1.8\text{E-}5$  kg/m·s and  $\rho = 1.31$  kg/m<sup>3</sup>. There would be approximately 12000 straws, but each one would see the average velocity of 6 m/s. Thus

$$\Delta p_{\text{laminar}} = \frac{32\mu LV}{d^2} = \frac{32(1.8\text{E-}5)(0.3)(6.0)}{(0.004)^2} \approx \mathbf{65 \text{ Pa}} \quad \text{Ans.}$$

Check  $Re = \rho Vd/\mu = (1.31)(6.0)(0.004)/(1.8\text{E-}5) \approx 1750$  OK, laminar flow.

**6.29** Oil, with  $\rho = 890$  kg/m<sup>3</sup> and  $\mu = 0.07$  kg/m·s, flows through a horizontal pipe 15 m long. The power delivered to the flow is 1 hp. (a) What is the appropriate pipe diameter if the flow is at the laminar transition point? For this condition, what are (b)  $Q$  in m<sup>3</sup>/h; and (c)  $\tau_w$  in kPa?

**Solution:** (a, b) Set the Reynolds number equal to 2300 and the (laminar) power equal to 1 hp:

$$Re_d = 2300 = \frac{(890 \text{ kg/m}^3)Vd}{0.07 \text{ kg/m}\cdot\text{s}} \quad \text{or} \quad Vd = 0.181 \text{ m}^2/\text{s}$$

$$\text{Power} = 1 \text{ hp} = 745.7 \text{ W} = Q\Delta p_{\text{laminar}} = \left(\frac{\pi}{4}d^2V\right)\left(\frac{32\mu LV}{d^2}\right) = \left(\frac{\pi}{4}\right)32(0.07)(15)V^2$$

$$\text{Solve for } V = 5.32 \frac{\text{m}}{\text{s}} \quad \text{and} \quad \mathbf{d = 0.034 \text{ m}} \quad \text{Ans. (a)}$$

It follows that  $Q = (\pi/4)d^2V = (\pi/4)(0.034 \text{ m})^2(5.32 \text{ m/s}) = 0.00484 \text{ m}^3/\text{s} = \mathbf{17.4 \text{ m}^3/\text{h}}$  Ans. (b)

(c) From Eq. (6.12), the wall shear stress is

$$\tau_w = \frac{8\mu V}{d} = \frac{8(0.07 \text{ kg/m}\cdot\text{s})(5.32 \text{ m/s})}{(0.034 \text{ m})} = 88 \text{ Pa} = \mathbf{0.088 \text{ kPa}} \quad \text{Ans. (c)}$$

**6.30** SAE 10 oil at 20°C flows through the 4-cm-diameter vertical pipe of Fig. P6.30. For the mercury manometer reading  $h = 42$  cm shown, (a) calculate the volume flow rate in  $\text{m}^3/\text{h}$ , and (b) state the direction of flow.

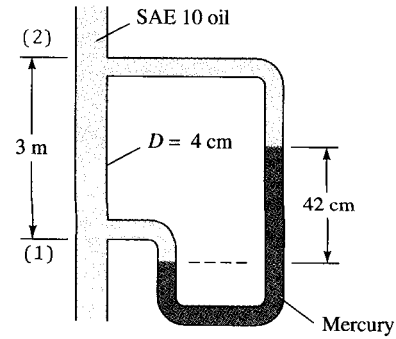


Fig. P6.30

**Solution:** For SAE 10 oil, take  $\rho = 870 \text{ kg/m}^3$  and  $\mu = 0.104 \text{ kg/m}\cdot\text{s}$ . The pressure at the lower point (1) is considerably higher than  $p_2$  according to the manometer reading:

$$p_1 - p_2 = (\rho_{\text{Hg}} - \rho_{\text{oil}})g\Delta h = (13550 - 870)(9.81)(0.42) \approx 52200 \text{ Pa}$$

$$\Delta p/(\rho_{\text{oil}}g) = 52200/[870(9.81)] \approx 6.12 \text{ m}$$

This is more than 3 m of oil, therefore it must include a friction loss: **flow is up**. Ans. (b)  
The energy equation between (1) and (2), with  $V_1 = V_2$ , gives

$$\frac{p_1 - p_2}{\rho g} = z_2 - z_1 + h_f, \quad \text{or} \quad 6.12 \text{ m} = 3 \text{ m} + h_f, \quad \text{or:} \quad h_f \approx 3.12 \text{ m} = \frac{128\mu LQ}{\pi\rho g d^4}$$

$$\text{Compute } Q = \frac{(6.12 - 3)\pi(870)(9.81)(0.04)^4}{128(0.104)(3.0)} = 0.00536 \frac{\text{m}^3}{\text{s}} \approx \mathbf{19.3 \frac{\text{m}^3}{\text{h}}} \quad \text{Ans. (a)}$$

Check  $Re = 4\rho Q/(\pi\mu d) = 4(870)(0.00536)/[\pi(0.104)(0.04)] \approx 1430$  (OK, laminar flow).

**6.31** Light oil,  $\rho = 880 \text{ kg/m}^3$  and  $\mu = 0.015 \text{ kg/(m}\cdot\text{s)}$ , flows down a vertical 6-mm-diameter tube due to gravity only. Estimate the volume flow rate in  $\text{m}^3/\text{h}$  if (a)  $L = 1$  m and (b)  $L = 2$  m. (c) Verify that the flow is laminar.

**Solution:** If the flow is due to gravity only, the head loss matches the elevation change:

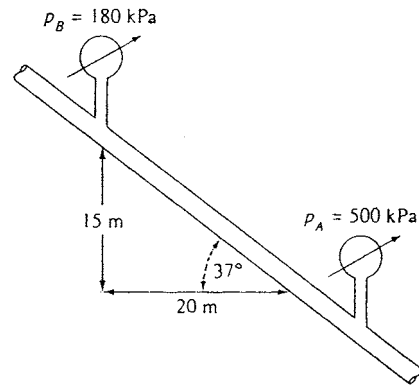
$$h_f = \Delta z = L = \frac{128\mu LQ}{\pi\rho g d^4}, \quad \text{or} \quad Q = \frac{\pi\rho g d^4}{128\mu} \quad \text{independent of pipe length}$$

For this case,

$$Q = \pi(880)(9.81)(0.006)^4/[128(0.015)] \approx 1.83\text{E-}5 \frac{\text{m}^3}{\text{s}} = \mathbf{0.066 \frac{\text{m}^3}{\text{h}}} \quad \text{Ans. (a, b)}$$

Check  $Re = 4\rho Q/(\pi\mu d) = 4(880)(1.83\text{E-}5)/[\pi(0.015)(0.006)] \approx \mathbf{228}$  (laminar). Ans. (c)

**6.32** SAE 30 oil at 20°C flows in the 3-cm-diameter pipe in Fig. P6.32, which slopes at 37°. For the pressure measurements shown, determine (a) whether the flow is up or down and (b) the flow rate in m<sup>3</sup>/h.



**Fig. P6.32**

**Solution:** For SAE 30 oil, take  $\rho = 891$  kg/m<sup>3</sup> and  $\mu = 0.29$  kg/m·s. Evaluate the hydraulic grade lines:

$$\text{HGL}_B = \frac{p_B}{\rho g} + z_B = \frac{180000}{891(9.81)} + 15 = 35.6 \text{ m}; \quad \text{HGL}_A = \frac{500000}{891(9.81)} + 0 = 57.2 \text{ m}$$

Since  $\text{HGL}_A > \text{HGL}_B$  the flow is up Ans. (a)

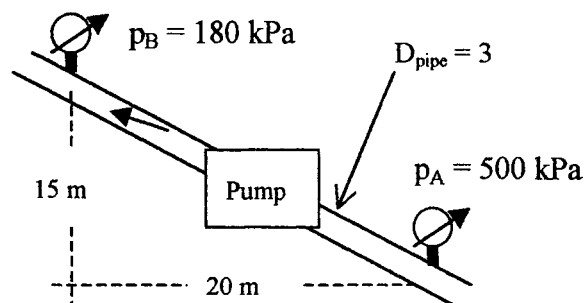
The head loss is the difference between hydraulic grade levels:

$$h_f = 57.2 - 35.6 = 21.6 \text{ m} = \frac{128\mu L Q}{\pi \rho g d^4} = \frac{128(0.29)(25)Q}{\pi(891)(9.81)(0.03)^4}$$

Solve for  $Q = 0.000518 \text{ m}^3/\text{s} \approx \mathbf{1.86 \text{ m}^3/\text{h}}$  Ans. (b)

Finally, check  $\text{Re} = 4\rho Q/(\pi\mu d) \approx 68$  (OK, laminar flow).

**6.33** In Problem 6.32, suppose it is desired to add a pump between A and B to drive the oil upward from A to B at a rate of 3 kg/s. At 100% efficiency, what pump power is required?



**Fig. P6.33**

**Solution:** For SAE 30 oil at 20°C,  $\rho = 891 \text{ kg/m}^3$  and  $\mu = 0.29 \text{ kg/m}\cdot\text{s}$ . With mass flow known, we can evaluate the pipe velocity:

$$V = \frac{\dot{m}}{\rho A} = \frac{3 \text{ kg/s}}{891\pi(0.015)^2} = 4.76 \frac{\text{m}}{\text{s}},$$

$$\text{Check } Re_d = \frac{891(4.76)(0.03)}{0.29} = \mathbf{439} \text{ (OK, laminar)}$$

Apply the steady flow energy equation between A and B:

$$\frac{p_A}{\rho g} + \frac{V_A^2}{2g} + z_A = \frac{p_B}{\rho g} + \frac{V_B^2}{2g} + z_B + h_f - h_p, \quad \text{or: } \frac{500000}{891(9.81)} = \frac{180000}{891(9.81)} + 15 + h_f - h_p$$

$$\text{where } h_f = \frac{32\mu LV}{\rho g d^2} = \frac{32(0.29)(25)(4.76)}{891(9.81)(0.03)^2} = 140.5 \text{ m}, \quad \text{Solve for } h_{pump} = 118.9 \text{ m}$$

The pump power is then given by

$$\mathbf{Power} = \rho g Q h_p = \dot{m} g h_p = \left(3 \frac{\text{kg}}{\text{s}}\right) \left(9.81 \frac{\text{m}}{\text{s}^2}\right) (118.9 \text{ m}) = \mathbf{3500 \text{ watts}} \quad \text{Ans.}$$

**6.34** Derive the time-averaged  $x$ -momentum equation (6.21) by direct substitution of Eqs. (6.19) into the momentum equation (6.14). It is convenient to write the convective acceleration as

$$\frac{d\mathbf{u}}{dt} = \frac{\partial}{\partial x}(u^2) + \frac{\partial}{\partial y}(uv) + \frac{\partial}{\partial z}(uw)$$

which is valid because of the continuity relation, Eq. (6.14).

**Solution:** Into the  $x$ -momentum eqn. substitute  $u = \bar{u} + u'$ ,  $v = \bar{v} + v'$ , etc., to obtain

$$\begin{aligned} \rho \left[ \frac{\partial}{\partial x}(\bar{u}^2 + 2\bar{u}u' + u'^2) + \frac{\partial}{\partial y}(\bar{v}\bar{u} + \bar{v}u' + v'\bar{u} + v'u') + \frac{\partial}{\partial z}(\bar{w}\bar{u} + \bar{w}u' + w'\bar{u} + w'u') \right] \\ = -\frac{\partial}{\partial x}(\bar{p} + p') + \rho g_x + \mu[\nabla^2(\bar{u} + u')] \end{aligned}$$

Now take the time-average of the entire equation to obtain Eq. (6.21) of the text:

$$\rho \left[ \frac{d\bar{u}}{dt} + \frac{\partial}{\partial x}(\overline{u'^2}) + \frac{\partial}{\partial y}(\overline{u'v'}) + \frac{\partial}{\partial z}(\overline{u'w'}) \right] = -\frac{\partial \bar{p}}{\partial x} + \rho g_x + \mu \nabla^2(\bar{u}) \quad \text{Ans.}$$

**6.35** By analogy with Eq. (6.21) write the turbulent mean-momentum differential equation for (a) the  $y$  direction and (b) the  $z$  direction. How many turbulent stress terms appear in each equation? How many unique turbulent stresses are there for the total of three directions?

**Solution:** You can re-derive, as in Prob. 6.34, or just permute the axes:

$$\begin{aligned} \text{(a) } y: \quad \rho \frac{d\bar{v}}{dt} &= -\frac{\partial \bar{p}}{\partial y} + \rho g_y + \frac{\partial}{\partial x} \left( \mu \frac{\partial \bar{v}}{\partial x} - \rho u'v' \right) + \frac{\partial}{\partial y} \left( \mu \frac{\partial \bar{v}}{\partial y} - \rho v'v' \right) \\ &\quad + \frac{\partial}{\partial z} \left( \mu \frac{\partial \bar{v}}{\partial z} - \rho v'w' \right) \\ \text{(b) } z: \quad \rho \frac{d\bar{w}}{dt} &= -\frac{\partial \bar{p}}{\partial z} + \rho g_z + \frac{\partial}{\partial x} \left( \mu \frac{\partial \bar{w}}{\partial x} - \rho u'w' \right) + \frac{\partial}{\partial y} \left( \mu \frac{\partial \bar{w}}{\partial y} - \rho v'w' \right) \\ &\quad + \frac{\partial}{\partial z} \left( \mu \frac{\partial \bar{w}}{\partial z} - \rho w'w' \right) \end{aligned}$$

**6.36** The following turbulent-flow velocity data  $u(y)$ , for air at 75°F and 1 atm near a smooth flat wall, were taken in the University of Rhode Island wind tunnel:

$y$ , in:	0.025	0.035	0.047	0.055	0.065
$u$ , ft/s:	51.2	54.2	56.8	57.6	59.1

Estimate (a) the wall shear stress and (b) the velocity  $u$  at  $y = 0.22$  in.

**Solution:** For air at 75°F and 1 atm, take  $\rho = 0.00230$  slug/ft<sup>3</sup> and  $\mu = 3.80\text{E-}7$  slug/ft·s. We fit each data point to the logarithmic-overlap law, Eq. (6.28):

$$\frac{u}{u^*} \approx \frac{1}{\kappa} \ln \frac{\rho u^* y}{\mu} + B \approx \frac{1}{0.41} \ln \left[ \frac{0.0023 u^* y}{3.80\text{E-}7} \right] + 5.0, \quad u^* = \sqrt{\tau_w / \rho}$$

Enter each value of  $u$  and  $y$  from the data and estimate the friction velocity  $u^*$ :

$y$ , in:	0.025	0.035	0.047	0.055	0.065
$u^*$ , ft/s:	<b>3.58</b>	<b>3.58</b>	<b>3.59</b>	<b>3.56</b>	<b>3.56</b>
$yu^*/\nu$ (approx):	45	63	85	99	117

Each point gives a good estimate of  $u^*$ , because each point is within the logarithmic layer in Fig. 6.10 of the text. The overall average friction velocity is

$$u_{\text{avg}}^* \approx 3.57 \frac{\text{ft}}{\text{s}} \pm 1\%, \quad \tau_{w,\text{avg}} = \rho u^*{}^2 = (0.0023)(3.57)^2 \approx \mathbf{0.0293} \frac{\text{lbf}}{\text{ft}^2} \quad \text{Ans. (a)}$$

Out at  $y = 0.22$  inches, we may estimate that the log-law still holds:

$$\frac{\rho u^* y}{\mu} = \frac{0.0023(3.57)(0.22/12)}{3.80E-7} \approx 396, \quad u \approx u^* \left[ \frac{1}{0.41} \ln(396) + 5.0 \right]$$

or:  $u \approx (3.57)(19.59) \approx 70 \frac{\text{ft}}{\text{s}}$  Ans. (b)

Figure 6.10 shows that this point ( $y^+ \approx 396$ ) seems also to be within the logarithmic layer.

**6.37** Two infinite plates a distance  $h$  apart are parallel to the  $xz$  plane with the upper plate moving at speed  $V$ , as in Fig. P6.37. There is a fluid of viscosity  $\mu$  and constant pressure between the plates. Neglecting gravity and assuming incompressible turbulent flow  $u(y)$  between the plates, use the logarithmic law and appropriate boundary conditions to derive a formula for dimensionless wall shear stress versus dimensionless plate velocity. Sketch a typical shape of the profile  $u(y)$ .

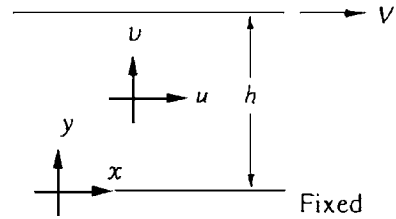
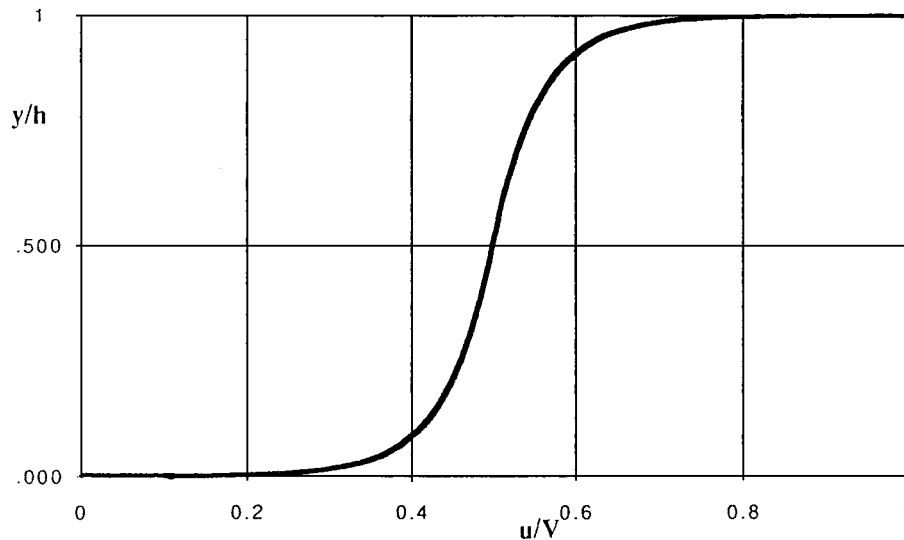


Fig. P6.37

**Solution:** The shear stress between parallel plates is *constant*, so the centerline velocity must be exactly  $u = V/2$  at  $y = h/2$ . Anti-symmetric log-laws form, one with increasing velocity for  $0 < y < h/2$ , and one with decreasing velocity for  $h/2 < y < h$ , as shown below:



The match-point at the center gives us a log-law estimate of the shear stress:

$$\frac{V}{2u^*} \approx \frac{1}{\kappa} \ln\left(\frac{hu^*}{2\nu}\right) + B, \quad \kappa \approx 0.41, B \approx 5.0, u^* = (\tau_w/\rho)^{1/2} \quad \text{Ans.}$$

This is one form of “dimensionless shear stress.” The more normal form is friction coefficient versus Reynolds number. Calculations from the log-law fit a Power-law curve-fit expression in the range  $2000 < \text{Re}_h < 1\text{E}5$ :

$$C_f = \frac{\tau_w}{(1/2)\rho V^2} \approx \frac{0.018}{(\rho V h/\nu)^{1/4}} = \frac{0.018}{\text{Re}_h^{1/4}} \quad \text{Ans.}$$

**6.38** Suppose in Fig. P6.37 that  $h = 3$  cm, the fluid is water at  $20^\circ\text{C}$  ( $\rho = 998$  kg/m<sup>3</sup>,  $\mu = 0.001$  kg/m·s), and the flow is turbulent, so that the logarithmic law is valid. If the shear stress in the fluid is 15 Pa, estimate  $V$  in m/s.

**Solution:** Just as in Prob. 6.37, apply the log-law at the center between the wall, that is,  $y = h/2$ ,  $u = V/2$ . With  $\tau_w$  known, we can evaluate  $u^*$  immediately:

$$u^* = \sqrt{\frac{\tau_w}{\rho}} = \sqrt{\frac{15}{998}} = 0.123 \frac{\text{m}}{\text{s}}, \quad \frac{V/2}{u^*} \approx \frac{1}{\kappa} \ln\left(\frac{u^* h/2}{\nu}\right) + B,$$

$$\text{or: } \frac{V/2}{0.123} = \frac{1}{0.41} \ln\left[\frac{0.123(0.03/2)}{0.001/998}\right] + 5.0 = 23.3, \quad \text{Solve for } V \approx 5.72 \frac{\text{m}}{\text{s}} \quad \text{Ans.}$$

**6.39** By analogy with laminar shear,  $\tau = \mu du/dy$ . T. V. Boussinesq in 1877 postulated that turbulent shear could also be related to the mean-velocity gradient  $\tau_{\text{urb}} = \varepsilon du/dy$ , where  $\varepsilon$  is called the *eddy viscosity* and is much larger than  $\mu$ . If the logarithmic-overlap law, Eq. (6.28), is valid with  $\tau \approx \tau_w$ , show that  $\varepsilon \approx \kappa \rho u^* y$ .

**Solution:** Differentiate the log-law, Eq. (6.28), to find  $du/dy$ , then introduce the eddy viscosity into the turbulent stress relation:

$$\text{If } \frac{u}{u^*} = \frac{1}{\kappa} \ln\left(\frac{yu^*}{\nu}\right) + B, \quad \text{then } \frac{du}{dy} = \frac{u^*}{\kappa y}$$

$$\text{Then, if } \tau \approx \tau_w \equiv \rho u^{*2} = \varepsilon \frac{du}{dy} = \varepsilon \frac{u^*}{\kappa y}, \quad \text{solve for } \varepsilon = \kappa \rho u^* y \quad \text{Ans.}$$



**6.40** Theodore von Kármán in 1930 theorized that turbulent shear could be represented by  $\tau_{\text{turb}} = \varepsilon du/dy$  where  $\varepsilon = \rho\kappa^2 y^2 |du/dy|$  is called the *mixing-length eddy viscosity* and  $\kappa \approx 0.41$  is Kármán's dimensionless *mixing-length constant* [2,3]. Assuming that  $\tau_{\text{turb}} \approx \tau_w$  near the wall, show that this expression can be integrated to yield the logarithmic-overlap law, Eq. (6.28).

**Solution:** This is accomplished by straight substitution:

$$\tau_{\text{turb}} \approx \tau_w = \rho u^{*2} = \varepsilon \frac{du}{dy} = \left[ \rho \kappa^2 y^2 \left| \frac{du}{dy} \right| \right] \frac{du}{dy}, \quad \text{solve for } \frac{du}{dy} = \frac{u^*}{\kappa y}$$

$$\text{Integrate: } \int du = \frac{u^*}{\kappa} \int \frac{dy}{y}, \quad \text{or: } \mathbf{u = \frac{u^*}{\kappa} \ln(y) + \text{constant} \quad \text{Ans.}}$$

To convert this to the exact form of Eq. (6.28) requires fitting to experimental data.

**6.41** Water at 20°C flows in a 9-cm-diameter pipe under fully developed conditions. The centerline velocity is 10 m/s. Compute (a)  $Q$ , (b)  $V$ , (c)  $\tau_w$ , and (d)  $\Delta p$  for a 100-m pipe length.

**Solution:** For water at 20°C, take  $\rho = 998 \text{ kg/m}^3$  and  $\mu = 0.001 \text{ kg/m}\cdot\text{s}$ . Check  $Re = \rho V D / \mu \approx 998(10)(0.09)/0.001 \approx 900,000$ , surely a turbulent flow. Use the log-law:

$$\frac{u_{\text{ctr}}}{u^*} \approx \frac{1}{\kappa} \ln \left( \frac{R u^*}{\nu} \right) + B, \quad \text{or: } \frac{10}{u^*} \approx \frac{1}{0.41} \ln \left[ \frac{998(0.045)u^*}{0.001} \right] + 5.0, \quad \text{solve } u^* \approx 0.350 \frac{\text{m}}{\text{s}}$$

$$\text{Then } \tau_w = \rho u^{*2} = (998)(0.350)^2 \approx \mathbf{122 \text{ Pa}} \quad \text{Ans. (c)}$$

We know that average velocity  $V$  is slightly less than centerline velocity, but we probably wouldn't know at this stage the *formula* for  $V$  from Eq. (6.43). So just make an estimate:

$$V \approx 0.85 u_{\text{ctr}} = (0.85)(10) \approx \mathbf{8.5 \frac{m}{s}} \quad \text{Ans. (b)}$$

$$Q = AV \approx (\pi/4)(0.09)^2(8.5) \approx \mathbf{0.054 \text{ m}^3/\text{s}} \quad \text{Ans. (a)}$$

Finally, assuming fully-developed horizontal flow, we use Eq. (6.9b) to compute  $\Delta p$ :

$$\Delta p = \frac{2\tau_w \Delta L}{R} = \frac{2(122 \text{ Pa})(100 \text{ m})}{(0.045 \text{ m})} \approx \mathbf{542,000 \text{ Pa}} \quad \text{Ans. (d)}$$

**6.42** It is clear by comparing Figs. 6.12*b* and 6.13 that the effects of sand roughness and commercial (manufactured) roughness are not quite the same. Take the special case of commercial roughness ratio  $\varepsilon/d = 0.001$  in Fig. 6.13, and replot in the form of the wall-law shift  $\Delta B$  (Fig. 6.12*a*) versus the logarithm of  $\varepsilon^+ = \varepsilon u^*/\nu$ . Compare your plot with Eq. (6.45).

**Solution:** To make this plot we must relate  $\Delta B$  to the Moody-chart friction factor. We use Eq. (6.33) of the text, which is valid for any  $B$ , in this case,  $B = B_o - \Delta B$ , where  $B_o \approx 5.0$ :

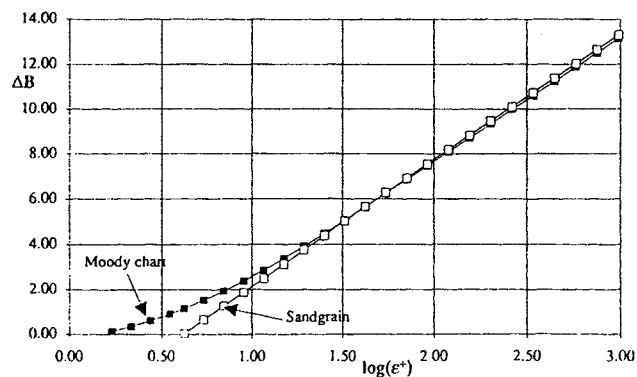
$$\frac{V}{u^*} \approx \frac{1}{\kappa} \ln\left(\frac{Ru^*}{\nu}\right) + B_o - \Delta B - \frac{3}{2\kappa}, \quad \text{where } \frac{V}{u^*} = \sqrt{\frac{8}{f}} \quad \text{and} \quad \frac{Ru^*}{\nu} = \frac{1}{2} Re_d \sqrt{\frac{f}{8}} \quad (1)$$

Combine Eq. (1) with the Colebrook friction formula (6.48) and the definition of  $\varepsilon^+$ :

$$\frac{1}{\sqrt{f}} \approx -2.0 \log_{10}\left(\frac{\varepsilon/d}{3.7} + \frac{2.51}{Re\sqrt{f}}\right) \quad (2)$$

$$\text{and } \varepsilon^+ = \frac{\varepsilon u^*}{\nu} = \frac{\varepsilon}{d} d^+ = \frac{\varepsilon}{d} Re \sqrt{\frac{f}{8}} \quad (3)$$

Equations (1, 2, 3) enable us to make the plot below of “commercial” log-shift  $\Delta B$ , which is similar to the ‘sand-grain’ shift predicted by Eq. (6.45):  $\Delta B_{\text{sand}} \approx (1/\kappa)\ln(\varepsilon^+) - 3.5$ .



**Fig. P6.42**

**6.43** Water at 20°C flows for 1 mi through a 3-in-diameter horizontal wrought-iron pipe at 250 gal/min. Estimate the head loss and the pressure drop in this length of pipe.

**Solution:** For water at 20°C, take  $\rho = 1.94$  slug/ft<sup>3</sup> and  $\mu = 2.09E-5$  slug/ft·s. Convert 250 gal/min  $\div 448.8 = 0.557$  ft<sup>3</sup>/s. For wrought iron take  $\varepsilon \approx 0.00015$  ft. Then compute

$$V = \frac{0.557}{(\pi/4)(3/12)^2} = 11.35 \frac{\text{ft}}{\text{s}}; \quad Re = \frac{1.94(11.35)(3/12)}{2.09E-5} = 263000 \text{ (turbulent flow)}$$

$$\frac{\varepsilon}{d} = \frac{0.00015}{3/12} = 0.0006; \quad \text{Moody chart or Eq. (6.48): } f \approx 0.0189$$

With  $f$  known, we compute the head loss and (horizontal) pressure drop as

$$h_f = f \frac{L V^2}{d 2g} = (0.0189) \left( \frac{5280}{3/12} \right) \frac{1(11.35)^2}{2(32.2)} \approx \mathbf{800 \text{ ft}} \quad \text{Ans. (a)}$$

$$\text{and } \Delta p = \rho g h_f = (1.94)(32.2)(800) \approx \mathbf{49900 \frac{\text{lbf}}{\text{ft}^2}} \quad \text{Ans. (b)}$$

**6.44** Mercury at 20°C flows through 4 meters of 7-mm-diameter glass tubing at an average velocity of 5 m/s. Estimate the head loss in meters and the pressure drop in kPa.

**Solution:** For mercury at 20°C, take  $\rho = 13550 \text{ kg/m}^3$  and  $\mu = 0.00156 \text{ kg/m}\cdot\text{s}$ . Glass tubing is considered hydraulically “smooth,”  $\varepsilon/d = 0$ . Compute the Reynolds number:

$$Re_d = \frac{\rho V d}{\mu} = \frac{13550(5)(0.007)}{0.00156} = 304,000; \quad \text{Moody chart smooth: } f \approx 0.0143$$

$$h_f = f \frac{L V^2}{d 2g} = 0.0143 \left( \frac{4.0}{0.007} \right) \frac{5^2}{2(9.81)} = \mathbf{10.4 \text{ m}} \quad \text{Ans. (a)}$$

$$\Delta p = \rho g h_f = (13550)(9.81)(10.4) = 1,380,000 \text{ Pa} = \mathbf{1380 \text{ kPa}} \quad \text{Ans. (b)}$$

**6.45** Oil,  $SG = 0.88$  and  $\nu = 4E-5 \text{ m}^2/\text{s}$ , flows at 400 gal/min through a 6-inch asphalted cast-iron pipe. The pipe is 0.5 miles long (2640 ft) and slopes upward at  $8^\circ$  in the flow direction. Compute the head loss in feet and the pressure change.

**Solution:** First convert 400 gal/min = 0.891 ft<sup>3</sup>/s and  $\nu = 0.000431 \text{ ft}^2/\text{s}$ . For asphalted cast-iron,  $\varepsilon = 0.0004 \text{ ft}$ , hence  $\varepsilon/d = 0.0004/0.5 = 0.0008$ . Compute  $V$ ,  $Re_d$ , and  $f$ :

$$V = \frac{0.891}{\pi(0.25)^2} = 4.54 \frac{\text{ft}}{\text{s}}; \quad Re_d = \frac{4.54(0.5)}{0.000431} = 5271; \quad \text{calculate } f_{\text{Moody}} = 0.0377$$

$$\text{then } h_f = f \frac{L V^2}{d 2g} = 0.0377 \left( \frac{2640}{0.5} \right) \frac{(4.54)^2}{2(32.2)} = \mathbf{63.8 \text{ ft}} \quad \text{Ans. (a)}$$

If the pipe slopes upward at  $8^\circ$ , the pressure drop must balance both friction and gravity:

$$\Delta p = \rho g (h_f + \Delta z) = 0.88(62.4)[63.8 + 2640 \sin 8^\circ] = \mathbf{23700 \frac{\text{lbf}}{\text{ft}^2}} \quad \text{Ans. (b)}$$

**6.46** Kerosene at 20°C is pumped at 0.15 m<sup>3</sup>/s through 20 km of 16-cm-diameter cast-iron horizontal pipe. Compute the input power in kW required if the pumps are 85 percent efficient.

**Solution:** For kerosene at 20°C, take  $\rho = 804 \text{ kg/m}^3$  and  $\mu = 1.92\text{E-}3 \text{ kg/m}\cdot\text{s}$ . For cast iron take  $\varepsilon \approx 0.26 \text{ mm}$ , hence  $\varepsilon/d = 0.26/160 \approx 0.001625$ . Compute  $V$ ,  $Re$ , and  $f$ :

$$V = \frac{0.15}{(\pi/4)(0.16)^2} = 7.46 \frac{\text{m}}{\text{s}}; \quad Re = \frac{4\rho Q}{\pi\mu d} = \frac{4(804)(0.15)}{\pi(0.00192)(0.16)} \approx 500,000$$

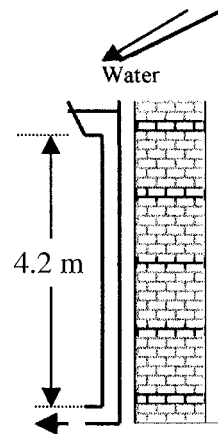
$$\varepsilon/d \approx 0.001625: \quad \text{Moody chart: } f \approx 0.0226$$

$$\text{Then } h_f = f \frac{L}{d} \frac{V^2}{2g} = (0.0226) \left( \frac{20000}{0.16} \right) \frac{(7.46)^2}{2(9.81)} \approx 8020 \text{ m}$$

At 85% efficiency, the pumping power required is:

$$P = \frac{\rho g Q h_f}{\eta} = \frac{804(9.81)(0.15)(8020)}{0.85} \approx 11.2\text{E}+6 \text{ W} = \mathbf{11.2 \text{ MW}} \quad \text{Ans.}$$

**6.47** The gutter and smooth drainpipe in Fig. P6.47 remove rainwater from the roof of a building. The smooth drainpipe is 7 cm in diameter. (a) When the gutter is full, estimate the rate of draining. (b) The gutter is designed for a sudden rainstorm of up to 5 inches per hour. For this condition, what is the maximum roof area that can be drained successfully?



**Fig. P6.47**

**Solution:** If the velocity at the gutter surface is neglected, the energy equation reduces to

$$\Delta z = \frac{V^2}{2g} + h_f, \quad h_f = f \frac{L}{d} \frac{V^2}{2g}, \quad \text{solve } V^2 = \frac{2g\Delta z}{1 + fL/d} = \frac{2(9.81)(4.2)}{1 + f(4.2/0.07)}$$

For water, take  $\rho = 998 \text{ kg/m}^3$  and  $\mu = 0.001 \text{ kg/m}\cdot\text{s}$ . Guess  $f \approx 0.02$  to obtain the velocity estimate  $V \approx 6 \text{ m/s}$  above. Then  $Re_d \approx \rho V d / \mu \approx (998)(6)(0.07)/(0.001) \approx 428,000$  (turbulent). Then, for a smooth pipe,  $f \approx 0.0135$ , and  $V$  is changed slightly to 6.74 m/s. After convergence, we obtain

$$V = 6.77 \text{ m/s}, \quad Q = V(\pi/4)(0.07)^2 = \mathbf{0.026 \text{ m}^3/\text{s}} \quad \text{Ans. (a)}$$

A rainfall of  $5 \text{ in/h} = (5/12 \text{ ft/h})(0.3048 \text{ m/ft})/(3600 \text{ s/h}) = 0.0000353 \text{ m/s}$ . The required roof area is

$$A_{\text{roof}} = Q_{\text{drain}}/V_{\text{rain}} = (0.026 \text{ m}^3/\text{s})/0.0000353 \text{ m/s} \approx \mathbf{740 \text{ m}^2} \quad \text{Ans. (b)}$$

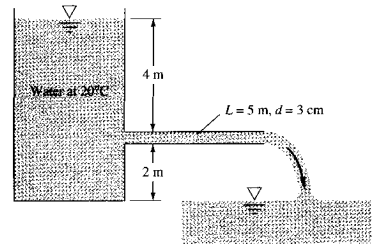
**6.48** Show that if Eq. (6.33) is accurate, the position in a turbulent pipe flow where local velocity  $u$  equals average velocity  $V$  occurs exactly at  $r = 0.777R$ , independent of the Reynolds number.

**Solution:** Simply find the log-law position  $y^+$  where  $u^+$  exactly equals  $V/u^*$ :

$$V = u^* \left[ \frac{1}{\kappa} \ln \frac{Ru^*}{\nu} + B - \frac{3}{2\kappa} \right] \stackrel{?}{=} u^* \left[ \frac{1}{\kappa} \ln \frac{yu^*}{\nu} + B \right] \quad \text{if} \quad \frac{1}{\kappa} \ln \frac{y}{R} = -\frac{3}{2\kappa}$$

$$\text{Since } y = R - r, \text{ this is equivalent to } \frac{r}{R} = 1 - e^{-3/2} = 1 - 0.223 \approx \mathbf{0.777} \quad \text{Ans.}$$

**6.49** The tank-pipe system of Fig. P6.49 is to deliver at least  $11 \text{ m}^3/\text{h}$  of water at  $20^\circ\text{C}$  to the reservoir. What is the maximum roughness height  $\varepsilon$  allowable for the pipe?



**Fig. P6.49**

**Solution:** For water at  $20^\circ\text{C}$ , take  $\rho = 998 \text{ kg/m}^3$  and  $\mu = 0.001 \text{ kg/m}\cdot\text{s}$ . Evaluate  $V$  and  $Re$  for the expected flow rate:

$$V = \frac{Q}{A} = \frac{11/3600}{(\pi/4)(0.03)^2} = 4.32 \frac{\text{m}}{\text{s}}; \quad Re = \frac{\rho V d}{\mu} = \frac{998(4.32)(0.03)}{0.001} = 129000$$

The energy equation yields the value of the head loss:

$$\frac{p_{\text{atm}}}{\rho g} + \frac{V_1^2}{2g} + z_1 = \frac{p_{\text{atm}}}{\rho g} + \frac{V_2^2}{2g} + z_2 + h_f \quad \text{or} \quad h_f = 4 - \frac{(4.32)^2}{2(9.81)} = 3.05 \text{ m}$$

$$\text{But also } h_f = f \frac{L}{d} \frac{V^2}{2g}, \quad \text{or: } 3.05 = f \left( \frac{5.0}{0.03} \right) \frac{(4.32)^2}{2(9.81)}, \quad \text{solve for } f \approx 0.0192$$

With  $f$  and  $Re$  known, we can find  $\varepsilon/d$  from the Moody chart or from Eq. (6.48):

$$\frac{1}{(0.0192)^{1/2}} = -2.0 \log_{10} \left[ \frac{\varepsilon/d}{3.7} + \frac{2.51}{129000(0.0192)^{1/2}} \right], \quad \text{solve for } \frac{\varepsilon}{d} \approx 0.000394$$

$$\text{Then } \varepsilon = 0.000394(0.03) \approx 1.2\text{E-}5 \text{ m} \approx \mathbf{0.012 \text{ mm}} \quad (\text{very smooth}) \quad \text{Ans.}$$

**6.50** Ethanol at 20°C flows at 125 U.S. gal/min through a horizontal cast-iron pipe with  $L = 12$  m and  $d = 5$  cm. Neglecting entrance effects, estimate (a) the pressure gradient,  $dp/dx$ ; (b) the wall shear stress,  $\tau_w$ ; and (c) the percent reduction in friction factor if the pipe walls are polished to a smooth surface.

**Solution:** For ethanol (Table A-3) take  $\rho = 789$  kg/m<sup>3</sup> and  $\mu = 0.0012$  kg/m·s. Convert 125 gal/min to 0.00789 m<sup>3</sup>/s. Evaluate  $V = Q/A = 0.00789/[\pi(0.05)^2/4] = 4.02$  m/s.

$$Re_d = \frac{\rho V d}{\mu} = \frac{789(4.02)(0.05)}{0.0012} = 132,000, \quad \frac{\varepsilon}{d} = \frac{0.26 \text{ mm}}{50 \text{ mm}} = 0.0052 \quad \text{Then } f_{\text{Moody}} \approx 0.0314$$

$$(b) \quad \tau_w = \frac{f}{8} \rho V^2 = \frac{0.0314}{8} (789)(4.02)^2 = \mathbf{50 \text{ Pa}} \quad \text{Ans. (b)}$$

$$(a) \quad \frac{dp}{dx} = -\frac{4\tau_w}{d} = \frac{-4(50)}{0.05} = \mathbf{-4000 \frac{\text{Pa}}{\text{m}}} \quad \text{Ans. (a)}$$

(c)  $Re = 132000$ ,  $f_{\text{smooth}} = 0.0170$ , hence the reduction in  $f$  is

$$\left(1 - \frac{0.0170}{0.0314}\right) = \mathbf{46\%} \quad \text{Ans. (c)}$$

**6.51** The viscous sublayer (Fig. 6.10) is normally less than 1 percent of the pipe diameter and therefore very difficult to probe with a finite-sized instrument. In an effort to generate a thick sublayer for probing, Pennsylvania State University in 1964 built a pipe with a flow of glycerin. Assume a smooth 12-in-diameter pipe with  $V = 60$  ft/s and glycerin at 20°C. Compute the sublayer thickness in inches and the pumping horsepower required at 75 percent efficiency if  $L = 40$  ft.

**Solution:** For glycerin at 20°C, take  $\rho = 2.44$  slug/ft<sup>3</sup> and  $\mu = 0.0311$  slug/ft·s. Then

$$Re = \frac{\rho V d}{\mu} = \frac{2.44(60)(1 \text{ ft})}{0.0311} = 4710 \quad (\text{barely turbulent!}) \quad \text{Smooth: } f_{\text{Moody}} \approx 0.0380$$

$$\text{Then } u^* = V(f/8)^{1/2} = 60 \left( \frac{0.0380}{8} \right)^{1/2} \approx 4.13 \frac{\text{ft}}{\text{s}}$$

The sublayer thickness is defined by  $y^+ \approx 5.0 = \rho y u^* / \mu$ . Thus

$$y_{\text{sublayer}} \approx \frac{5\mu}{\rho u^*} = \frac{5(0.0311)}{(2.44)(4.13)} = 0.0154 \text{ ft} \approx \mathbf{0.185 \text{ inches}} \quad \text{Ans.}$$

With  $f$  known, the head loss and the power required can be computed:

$$h_f = f \frac{L}{d} \frac{V^2}{2g} = (0.0380) \left( \frac{40}{1} \right) \frac{(60)^2}{2(32.2)} \approx 85 \text{ ft}$$

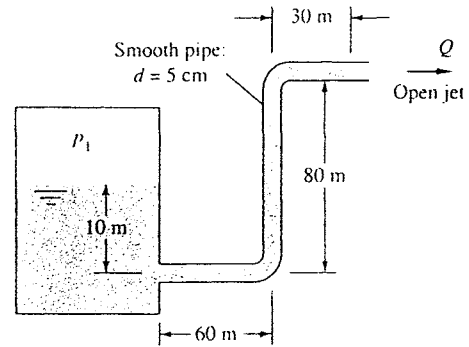
$$P = \frac{\rho g Q h_f}{\eta} = \frac{1}{0.75} (2.44)(32.2) \left[ \frac{\pi}{4} (1)^2 (60) \right] (85) = 419000 \div 550 \approx \mathbf{760 \text{ hp}} \quad \text{Ans.}$$

**6.52** The pipe flow in Fig. P6.52 is driven by pressurized air in the tank. What gage pressure  $p_1$  is needed to provide a  $20^\circ\text{C}$  water flow rate  $Q = 60 \text{ m}^3/\text{h}$ ?

**Solution:** For water at  $20^\circ\text{C}$ , take  $\rho = 998 \text{ kg/m}^3$  and  $\mu = 0.001 \text{ kg/m}\cdot\text{s}$ . Get  $V$ ,  $\text{Re}$ ,  $f$ :

$$V = \frac{60/3600}{(\pi/4)(0.05)^2} = 8.49 \frac{\text{m}}{\text{s}};$$

$$\text{Re} = \frac{998(8.49)(0.05)}{0.001} \approx 424000; \quad f_{\text{smooth}} \approx \mathbf{0.0136}$$



**Fig. P6.52**

Write the energy equation between points (1) (the tank) and (2) (the open jet):

$$\frac{p_1}{\rho g} + \frac{0^2}{2g} + 10 = \frac{0}{\rho g} + \frac{V_{\text{pipe}}^2}{2g} + 80 + h_f, \quad \text{where } h_f = f \frac{L}{d} \frac{V^2}{2g} \text{ and } V_{\text{pipe}} = 8.49 \frac{\text{m}}{\text{s}}$$

$$\text{Solve } p_1 = (998)(9.81) \left[ 80 - 10 + \frac{(8.49)^2}{2(9.81)} \left\{ 1 + 0.0136 \left( \frac{170}{0.05} \right) \right\} \right] \\ \approx \mathbf{2.38E6 \text{ Pa}} \quad \text{Ans.}$$

[This is a *gage* pressure (relative to the pressure surrounding the open jet.)]

**6.53** In Fig. P6.52 suppose  $p_1 = 700 \text{ kPa}$  and the fluid specific gravity is 0.68. If the flow rate is  $27 \text{ m}^3/\text{h}$ , estimate the viscosity of the fluid. What fluid in Table A-5 is the likely suspect?

**Solution:** Evaluate  $\rho = 0.68(998) = 679 \text{ kg/m}^3$ . Evaluate  $V = Q/A = (27/3600)/[\pi(0.025)^2] = 3.82 \text{ m/s}$ . The energy analysis of the previous problem now has  $f$  as the unknown:

$$\frac{p_1}{\rho g} = \frac{700000}{679(9.81)} = \Delta z + \frac{V^2}{2g} + f \frac{L}{d} \frac{V^2}{2g} = 70 + \frac{(3.82)^2}{2(9.81)} \left[ 1 + f \frac{170}{0.05} \right], \quad \text{solve } f = 0.0136$$

$$\text{Smooth pipe: } f = 0.0136, \quad Re_d = 416000 = \frac{679(3.82)(0.05)}{\mu},$$

$$\text{Solve } \mu = \mathbf{0.00031} \frac{\text{kg}}{\text{m}\cdot\text{s}} \quad \text{Ans.}$$

The density and viscosity are close to the likely suspect, **gasoline**. *Ans.*

**6.54\*** A swimming pool  $W$  by  $Y$  by  $h$  deep is to be emptied by gravity through the long pipe shown in Fig. P6.54. Assuming an average pipe friction factor  $f_{av}$  and neglecting minor losses, derive a formula for the time to empty the tank from an initial level  $h_o$ .

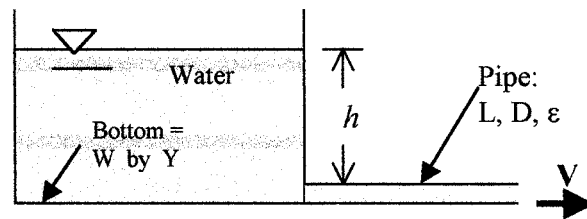


Fig. P6.54

**Solution:** With no driving pressure and negligible tank surface velocity, the energy equation can be combined with a control-volume mass conservation:

$$h(t) = \frac{V^2}{2g} + f_{av} \frac{L}{D} \frac{V^2}{2g}, \quad \text{or: } Q_{out} = A_{pipe} V = \frac{\pi}{4} D^2 \sqrt{\frac{2gh}{1 + f_{av}L/D}} = -WY \frac{dh}{dt}$$

We can separate the variables and integrate for time to drain:

$$\frac{\pi}{4} D^2 \sqrt{\frac{2g}{1 + f_{av}L/D}} \int_0^t dt = -WY \int_{h_o}^0 \frac{dh}{\sqrt{h}} = -WY (0 - 2\sqrt{h_o})$$

$$\text{Clean this up to obtain: } t_{drain} \approx \frac{4WY}{\pi D^2} \sqrt{\frac{2h_o(1 + f_{av}L/D)}{g}} \quad \text{Ans.}$$



**6.55** The reservoirs in Fig. P6.55 contain water at 20°C. If the pipe is smooth with  $L = 4500$  m and  $d = 4$  cm, what will the flow rate in  $\text{m}^3/\text{h}$  be for  $\Delta z = 100$  m?

**Solution:** For water at 20°C, take  $\rho = 998$   $\text{kg}/\text{m}^3$  and  $\mu = 0.001$   $\text{kg}/\text{m}\cdot\text{s}$ . The energy equation from surface 1 to surface 2 gives

$$p_1 = p_2 \quad \text{and} \quad V_1 = V_2,$$

thus  $h_f = z_1 - z_2 = 100$  m

$$\text{Then } 100 \text{ m} = f \left( \frac{4500}{0.04} \right) \frac{V^2}{2(9.81)}, \quad \text{or} \quad fV^2 \approx 0.01744$$

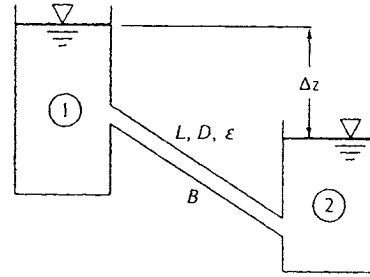
Iterate with an initial guess of  $f \approx 0.02$ , calculating  $V$  and  $Re$  and improving the guess:

$$V \approx \left( \frac{0.01744}{0.02} \right)^{1/2} \approx 0.934 \frac{\text{m}}{\text{s}}, \quad Re \approx \frac{998(0.934)(0.04)}{0.001} \approx 37300, \quad f_{\text{smooth}} \approx 0.0224$$

$$V_{\text{better}} \approx \left( \frac{0.01744}{0.0224} \right)^{1/2} \approx 0.883 \frac{\text{m}}{\text{s}}, \quad Re_{\text{better}} \approx 35300, \quad f_{\text{better}} \approx 0.0226, \text{ etc.....}$$

This process converges to

$$f = 0.0227, \quad Re = 35000, \quad V = 0.877 \text{ m/s}, \quad Q \approx 0.0011 \text{ m}^3/\text{s} \approx \mathbf{4.0 \text{ m}^3/\text{h}}. \quad \text{Ans.}$$



**Fig. P6.55**

**6.56** Consider a horizontal 4-ft-diameter galvanized-iron pipe simulating the Alaska Pipeline. The oil flow is 70 million U.S. gallons per day, at a density of 910  $\text{kg}/\text{m}^3$  and viscosity of 0.01  $\text{kg}/\text{m}\cdot\text{s}$  (see Fig. A.1 for SAE 30 oil at 100°C). Each pump along the line raises the oil pressure to 8 MPa, which then drops, due to head loss, to 400 kPa at the entrance to the next pump. Estimate (a) the appropriate distance between pumping stations; and (b) the power required if the pumps are 88% efficient.

**Solution:** For galvanized iron take  $\varepsilon = 0.15$  mm. Convert  $d = 4$  ft = 1.22 m. Convert  $Q = 7E7$  gal/day = 3.07  $\text{m}^3/\text{s}$ . The flow rate gives the velocity and Reynolds number:

$$V = \frac{Q}{A} = \frac{3.07}{\pi(1.22)^2/4} = 2.63 \frac{\text{m}}{\text{s}}; \quad Re_d = \frac{\rho V d}{\mu} = \frac{910(2.63)(1.22)}{0.01} = 292,500$$

$$\frac{\varepsilon}{d} = \frac{0.15 \text{ mm}}{1220 \text{ mm}} = 0.000123, \quad f_{\text{Moody}} \approx 0.0157$$

Relating the known pressure drop to friction factor yields the unknown pipe length:

$$\Delta p = 8,000,000 - 400,000 \text{ Pa} = f \frac{L}{d} \frac{\rho}{2} V^2 = 0.0157 \frac{L}{1.22} \left( \frac{910}{2} \right) (2.63)^2,$$

$$\text{Solve } L = \mathbf{188,000 \text{ m}} = 117 \text{ miles} \quad \text{Ans. (a)}$$

The pumping power required follows from the pressure drop and flow rate:

$$\begin{aligned} \text{Power} &= \frac{Q \Delta p}{\text{Efficiency}} = \frac{3.07(8E6 - 4E5)}{0.88} = 2.65E7 \text{ watts} \\ &= \mathbf{26.5 \text{ MW}} \text{ (35,500 hp)} \quad \text{Ans. (b)} \end{aligned}$$

**6.57** Apply the analysis of Prob. 6.54 to the following data. Let  $W = 5 \text{ m}$ ,  $Y = 8 \text{ m}$ ,  $h_o = 2 \text{ m}$ ,  $L = 15 \text{ m}$ ,  $D = 5 \text{ cm}$ , and  $\varepsilon = 0$ . (a) By letting  $h = 1.5 \text{ m}$  and  $0.5 \text{ m}$  as representative depths, estimate the average friction factor. Then (b) estimate the time to drain the pool.

**Solution:** For water, take  $\rho = 998 \text{ kg/m}^3$  and  $\mu = 0.001 \text{ kg/m}\cdot\text{s}$ . The velocity in Prob. 6.54 is calculated from the energy equation:

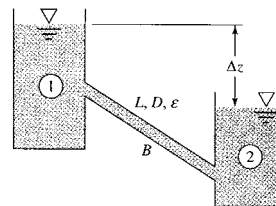
$$V = \sqrt{\frac{2gh}{1 + fL/D}} \quad \text{with } f = f_{cn}(\text{Re}_D)_{\text{smooth pipe}} \quad \text{and } \text{Re}_D = \frac{\rho V D}{\mu}, \quad L/D = 300$$

(a) With a bit of iteration for the Moody chart, we obtain  $\text{Re}_D = 108,000$  and  $f \approx 0.0177$  at  $h = 1.5 \text{ m}$ , and  $\text{Re}_D = 59,000$  and  $f \approx .0202$  at  $h = 0.5 \text{ m}$ ; thus the average value  $f_{av} \approx \mathbf{0.019}$ . *Ans. (a)*

The drain formula from Prob. 6.54 then predicts:

$$\begin{aligned} t_{\text{drain}} &\approx \frac{4WY}{\pi D^2} \sqrt{\frac{2h_o(1 + f_{av}L/D)}{g}} \approx \frac{4(5)(8)}{\pi(0.05)^2} \sqrt{\frac{2(2)[1 + 0.019(300)]}{9.81}} \\ &= 33700 \text{ s} = \mathbf{9.4 \text{ h}} \quad \text{Ans. (b)} \end{aligned}$$

**6.58** In Fig. P6.55 assume that the pipe is cast iron with  $L = 550 \text{ m}$ ,  $d = 7 \text{ cm}$ , and  $\Delta z = 100 \text{ m}$ . If an 80 percent efficient pump is placed at point  $B$ , what input power is required to deliver  $160 \text{ m}^3/\text{h}$  of water upward from reservoir 2 to 1?



**Fig. P6.55**

**Solution:** For water at 20°C, take  $\rho = 998 \text{ kg/m}^3$  and  $\mu = 0.001 \text{ kg/m}\cdot\text{s}$ . Compute  $V$ ,  $Re$ :

$$V = \frac{Q}{A} = \frac{160/3600}{(\pi/4)(0.07)^2} \approx 11.55 \frac{\text{m}}{\text{s}}; \quad Re = \frac{998(11.55)(0.07)}{0.001} \approx 807000$$

$$\frac{\varepsilon}{d} \Big|_{\text{cast iron}} = \frac{0.26 \text{ mm}}{70 \text{ mm}} \approx 0.00371; \quad \text{Moody chart: } f \approx 0.00280$$

The energy equation from surface 1 to surface 2, with a pump at B, gives

$$h_{\text{pump}} = \Delta z + h_f = 100 + (0.0280) \left( \frac{550}{0.07} \right) \frac{(11.55)^2}{2(9.81)} = 100 + 1494 \approx 1594 \text{ m}$$

$$\text{Power} = \frac{\rho g Q h_p}{\eta} = \frac{(998)(9.81)(160/3600)(1594)}{0.80} = 8.67\text{E}5 \text{ W} \approx \mathbf{867 \text{ kW}} \quad \text{Ans.}$$

**6.59** The following data were obtained for flow of 20°C water at 20 m<sup>3</sup>/hr through a badly corroded 5-cm-diameter pipe which slopes downward at an angle of 8°:  $p_1 = 420 \text{ kPa}$ ,  $z_1 = 12 \text{ m}$ ,  $p_2 = 250 \text{ kPa}$ ,  $z_2 = 3 \text{ m}$ . Estimate (a) the roughness ratio of the pipe; and (b) the percent change in head loss if the pipe were smooth and the flow rate the same.

**Solution:** The pipe length is given indirectly as  $L = \Delta z / \sin \theta = (9 \text{ m}) / \sin 8^\circ = 64.7 \text{ m}$ . The steady flow energy equation then gives the head loss:

$$\frac{p_1}{\rho g} + \frac{V_1^2}{2g} + z_1 = \frac{p_2}{\rho g} + \frac{V_2^2}{2g} + z_2 + h_f, \quad \text{or: } \frac{420000}{9790} + 12 = \frac{250000}{9790} + 3 + h_f,$$

$$\text{Solve } h_f = 26.4 \text{ m}$$

Now relate the head loss to the Moody friction factor:

$$h_f = 26.4 = f \frac{L V^2}{d 2g} = f \frac{64.7 (2.83)^2}{0.05 2(9.81)}, \quad \text{Solve } f = 0.050, \quad Re = 141000, \quad \text{Read } \frac{\varepsilon}{d} \approx 0.0211$$

The estimated (and uncertain) pipe roughness is thus  $\varepsilon = 0.0211d \approx \mathbf{1.06 \text{ mm}}$  Ans. (a)

(b) At the same  $Re_d = 141000$ ,  $f_{\text{smooth}} = 0.0168$ , or **66% less head loss.** Ans. (b)

**6.60** J. Nikuradse in 1932 suggested that smooth-wall turbulent pipe flow could be approximated by a Power-law profile

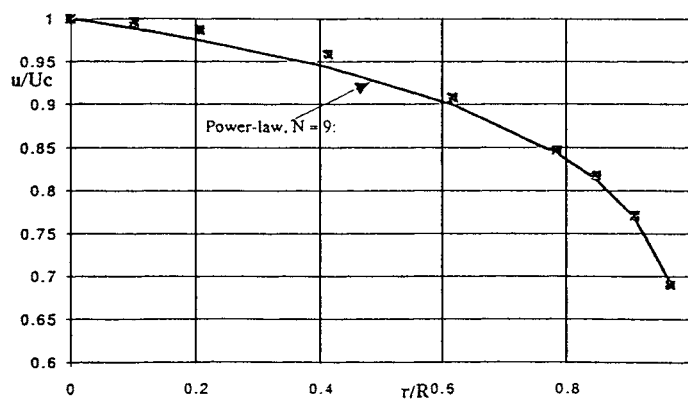
$$u/u_{\text{CL}} \approx \left( \frac{y}{R} \right)^{1/N}$$

where  $y$  is distance from the wall and  $N \approx 6$  to  $9$ . Find the best value of  $N$  which fits Laufer's data in Prob. C6.6. Then use your formula to estimate the pipe volume flow, and compare with the measured value of  $45 \text{ ft}^3/\text{s}$ .

**Solution:** Simply take the values of  $u$  and  $y$  from the data in Prob. C6.6 and evaluate " $N$ "  $\approx \ln(y/R)/\ln(u/u_{CL})$  for each data point. The results may be tabulated:

$y/R =$	0.898	0.794	0.588	0.383	0.216	0.154	0.093	0.037
$u/u_{CL} =$	0.997	0.988	0.959	0.908	0.847	0.818	0.771	0.690
" $N$ " =	35.7 (?)	19.1	12.7	<b>9.9</b>	<b>9.2</b>	<b>9.3</b>	<b>9.1</b>	<b>8.9</b>

Points near the wall are a good fit to  $N \approx 9$ . *Ans.* Points near the center are not a good fit, numerically, but they don't look bad in the graph below, because  $u/u_{CL}$  is near unity.



The Power-law may be integrated to find both  $V$  and  $Q$ :

$$V = \frac{1}{\pi R^2} \int_0^R u_{CL} \left( \frac{R-r}{R} \right)^{1/N} 2\pi r dr = u_{CL} \frac{2N^2}{(N+1)(2N+1)} = 0.853u_{CL} \quad \text{if } N \approx 9$$

$$\text{Then } V \approx 0.853(30.5) \approx 26.0 \frac{\text{m}}{\text{s}}, \quad Q = \frac{\pi}{4} (0.247)^2 (26.0) = 1.25 \frac{\text{m}^3}{\text{s}} \approx 44 \frac{\text{ft}^3}{\text{s}} \quad \text{Ans.}$$

**6.61** What level  $h$  must be maintained in Fig. P6.61 to deliver a flow rate of  $0.015 \text{ ft}^3/\text{s}$  through the  $\frac{1}{2}$ -in commercial-steel pipe?

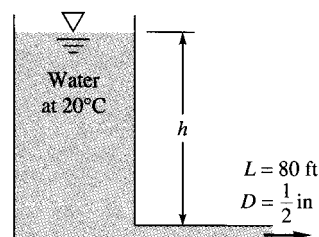


Fig. P6.61

**Solution:** For water at 20°C, take  $\rho = 1.94 \text{ slug/ft}^3$  and  $\mu = 2.09\text{E-}5 \text{ slug/ft}\cdot\text{s}$ . For commercial steel, take  $\varepsilon \approx 0.00015 \text{ ft}$ , or  $\varepsilon/d = 0.00015/(0.5/12) \approx 0.0036$ . Compute

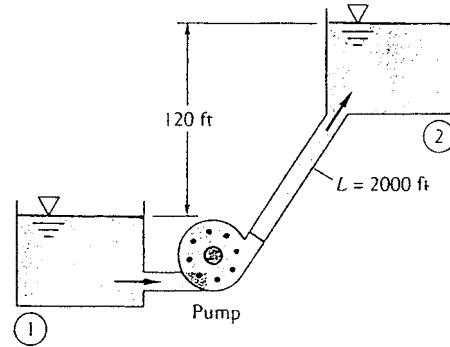
$$V = \frac{Q}{A} = \frac{0.015}{(\pi/4)(0.5/12)^2} = 11.0 \frac{\text{ft}}{\text{s}};$$

$$\text{Re} = \frac{\rho V d}{\mu} = \frac{1.94(11.0)(0.5/12)}{2.09\text{E-}5} \approx 42500 \quad \varepsilon/d = 0.0036, \quad f_{\text{Moody}} \approx 0.0301$$

The energy equation, with  $p_1 = p_2$  and  $V_1 \approx 0$ , yields an expression for surface elevation:

$$h = h_f + \frac{V^2}{2g} = \frac{V^2}{2g} \left( 1 + f \frac{L}{d} \right) = \frac{(11.0)^2}{2(32.2)} \left[ 1 + 0.0301 \left( \frac{80}{0.5/12} \right) \right] \approx \mathbf{111 \text{ ft}} \quad \text{Ans.}$$

**6.62** Water at 20°C is to be pumped through 2000 ft of pipe from reservoir 1 to 2 at a rate of 3 ft<sup>3</sup>/s, as shown in Fig. P6.62. If the pipe is cast iron of diameter 6 in and the pump is 75 percent efficient, what horsepower pump is needed?



**Fig. P6.62**

**Solution:** For water at 20°C, take  $\rho = 1.94 \text{ slug/ft}^3$  and  $\mu = 2.09\text{E-}5 \text{ slug/ft}\cdot\text{s}$ . For cast iron, take  $\varepsilon \approx 0.00085 \text{ ft}$ , or  $\varepsilon/d = 0.00085/(6/12) \approx 0.0017$ . Compute  $V$ ,  $\text{Re}$ , and  $f$ :

$$V = \frac{Q}{A} = \frac{3}{(\pi/4)(6/12)^2} = 15.3 \frac{\text{ft}}{\text{s}};$$

$$\text{Re} = \frac{\rho V d}{\mu} = \frac{1.94(15.3)(6/12)}{2.09\text{E-}5} \approx 709000 \quad \varepsilon/d = 0.0017, \quad f_{\text{Moody}} \approx 0.0227$$

The energy equation, with  $p_1 = p_2$  and  $V_1 \approx V_2 \approx 0$ , yields an expression for pump head:

$$h_{\text{pump}} = \Delta z + f \frac{L}{d} \frac{V^2}{2g} = 120 \text{ ft} + 0.0227 \left( \frac{2000}{6/12} \right) \frac{(15.3)^2}{2(32.2)} = 120 + 330 \approx 450 \text{ ft}$$

$$\text{Power: } P = \frac{\rho g Q h_p}{\eta} = \frac{1.94(32.2)(3.0)(450)}{0.75} = 112200 \div 550 \approx \mathbf{204 \text{ hp}} \quad \text{Ans.}$$

**6.63** A tank contains  $1 \text{ m}^3$  of water at  $20^\circ\text{C}$  and has a drawn-capillary outlet tube at the bottom, as in Fig. P6.63. Find the outlet volume flux  $Q$  in  $\text{m}^3/\text{h}$  at this instant.

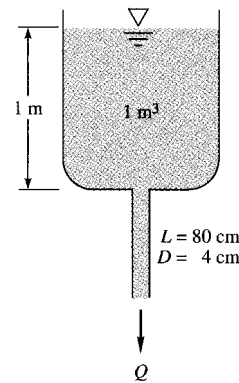


Fig. P6.63

**Solution:** For water at  $20^\circ\text{C}$ , take  $\rho = 998 \text{ kg/m}^3$  and  $\mu = 0.001 \text{ kg/m}\cdot\text{s}$ . For drawn tubing, take  $\varepsilon \approx 0.0015 \text{ mm}$ , or  $\varepsilon/d = 0.0015/40 \approx 0.0000375$ . The steady-flow energy equation, with  $p_1 = p_2$  and  $V_1 \approx 0$ , gives

$$h_f = f \frac{L}{d} \frac{V^2}{2g} = \Delta z - \frac{V^2}{2g}, \quad \text{or:} \quad \frac{V^2}{2g} \left( 1 + \frac{0.8}{0.04} f \right) \approx 1.8 \text{ m}, \quad V^2 \approx \frac{35.32}{1 + 20f}$$

$$\text{Guess } f \approx 0.015, \quad V = \left[ \frac{35.32}{1 + 20(0.015)} \right]^{1/2} \approx 5.21 \frac{\text{m}}{\text{s}}, \quad \text{Re} = \frac{998(5.21)(0.04)}{0.001} \approx 208000$$

$$f_{\text{better}} \approx 0.0158, \quad V_{\text{better}} \approx 5.18 \text{ m/s}, \quad \text{Re} \approx 207000 \text{ (converged)}$$

$$\text{Thus } V \approx 5.18 \text{ m/s}, \quad Q = (\pi/4)(0.04)^2(5.18) = 0.00651 \text{ m}^3/\text{s} \approx \mathbf{23.4 \text{ m}^3/\text{h}}. \quad \text{Ans.}$$

**6.64** Repeat Prob. 6.63 to find the flow rate if the fluid is SAE 10 oil. Is the flow laminar or turbulent?

**Solution:** For SAE 10 oil at  $20^\circ\text{C}$ , take  $\rho = 870 \text{ kg/m}^3$  and  $\mu = 0.104 \text{ kg/m}\cdot\text{s}$ . For drawn tubing, take  $\varepsilon \approx 0.0015 \text{ mm}$ , or  $\varepsilon/d = 0.0015/40 \approx 0.0000375$ . Guess laminar flow:

$$h_f = 1.8 \text{ m} - \frac{V^2}{2g} = \frac{32\mu LV}{\rho g d^2}, \quad \text{or:} \quad 1.8 - \frac{V^2}{2(9.81)} = \frac{32(0.104)(0.8)V}{870(9.81)(0.04)^2} = 0.195V$$

$$\text{Quadratic equation: } V^2 + 3.83V - 35.32 = 0, \quad \text{solve } V = 4.33 \text{ m/s}$$

$$\text{Check } \text{Re} = (870)(4.33)(0.04)/(0.104) \approx \mathbf{1450 \text{ (OK, laminar)}}$$

$$\text{So it is laminar flow, and } Q = (\pi/4)(0.04)^2(4.33) = 0.00544 \text{ m}^3/\text{s} = \mathbf{19.6 \text{ m}^3/\text{h}}. \quad \text{Ans.}$$

**6.65** In Prob. 6.63 the initial flow is turbulent. As the water drains out of the tank, will the flow revert to laminar motion as the tank becomes nearly empty? If so, at what tank depth? Estimate the time, in h, to drain the tank completely.

**Solution:** Recall that  $\rho = 998 \text{ kg/m}^3$ ,  $\mu = 0.001 \text{ kg/m}\cdot\text{s}$ , and  $\varepsilon/d \approx 0.0000375$ . Let  $Z$  be the depth of water in the tank ( $Z = 1 \text{ m}$  in Fig. P6.63). When  $Z = 0$ , find the flow rate:

$$Z = 0, h_f = 0.8 \text{ m}, \quad V^2 \approx \frac{2(9.81)(0.8)}{1 + 20f} \quad \text{converges to } f = 0.0171, \text{ Re} = 136000$$

$$V \approx 3.42 \text{ m/s}, \quad Q \approx 12.2 \text{ m}^3/\text{h} \quad (Z = 0)$$

So even when the tank is empty, the flow is still turbulent. *Ans.*

$$\text{The time to drain the tank is } \frac{d}{dt}(v_{\text{tank}}) = -Q = \frac{d}{dt}(A_{\text{tank}}Z) = (1 \text{ m}^2) \frac{dZ}{dt} = -Q,$$

$$\text{or } t_{\text{drain}} = - \int_{1\text{m}}^{0\text{m}} \frac{dZ}{Q} = \left( \frac{1}{Q} \right)_{\text{avg}} (1 \text{ m})$$

So all we need is the average value of  $(1/Q)$  during the draining period. We know  $Q$  at  $Z = 0$  and  $Z = 1 \text{ m}$ , let's check it also at  $Z = 0.5 \text{ m}$ : Calculate  $Q_{\text{midway}} \approx 19.8 \text{ m}^3/\text{h}$ . Then

$$\frac{1}{Q}_{\text{avg}} \approx \frac{1}{6} \left[ \frac{1}{23.4} + \frac{4}{19.8} + \frac{1}{12.2} \right] \approx 0.0544 \frac{\text{h}}{\text{m}^3}, \quad t_{\text{drain}} = \mathbf{0.0544 \text{ h} \approx 3.3 \text{ min}} \quad \text{Ans.}$$

**6.66** Ethyl alcohol at  $20^\circ\text{C}$  flows through a 10-cm horizontal drawn tube 100 m long. The fully developed wall shear stress is 14 Pa. Estimate (a) the pressure drop, (b) the volume flow rate, and (c) the velocity  $u$  at  $r = 1 \text{ cm}$ .

**Solution:** For ethyl alcohol at  $20^\circ\text{C}$ ,  $\rho = 789 \text{ kg/m}^3$ ,  $\mu = 0.0012 \text{ kg/m}\cdot\text{s}$ . For drawn tubing, take  $\varepsilon \approx 0.0015 \text{ mm}$ , or  $\varepsilon/d = 0.0015/100 \approx 0.000015$ . From Eq. (6.12),

$$\Delta p = 4\tau_w \frac{L}{d} = 4(14) \left( \frac{100}{0.1} \right) \approx \mathbf{56000 \text{ Pa}} \quad \text{Ans. (a)}$$

The wall shear is directly related to  $f$ , and we may iterate to find  $V$  and  $Q$ :

$$\tau_w = \frac{f}{8} \rho V^2, \quad \text{or: } fV^2 = \frac{8(14)}{789} = 0.142 \quad \text{with } \frac{\varepsilon}{d} = 0.000015$$

$$\text{Guess } f \approx 0.015, \quad V = \left[ \frac{0.142}{0.015} \right]^{1/2} \approx 3.08 \frac{\text{m}}{\text{s}}, \quad \text{Re} = \frac{789(3.08)(0.1)}{0.0012} \approx 202000$$

$$f_{\text{better}} \approx 0.0158, \quad V_{\text{better}} \approx 3.00 \text{ m/s}, \quad \text{Re}_{\text{better}} \approx 197000 \quad (\text{converged})$$

Then  $V \approx 3.00 \text{ m/s}$ , and  $Q = (\pi/4)(0.1)^2(3.00) = 0.0236 \text{ m}^3/\text{s} = 85 \text{ m}^3/\text{h}$ . *Ans.* (b)  
 Finally, the log-law Eq. (6.28) can estimate the velocity at  $r = 1 \text{ cm}$ , “ $y$ ” =  $R - r = 4 \text{ cm}$ :

$$u^* = \left( \frac{\tau_w}{\rho} \right)^{1/2} = \left( \frac{14}{789} \right)^{1/2} = 0.133 \frac{\text{m}}{\text{s}};$$

$$\frac{u}{u^*} \approx \frac{1}{\kappa} \ln \left[ \frac{\rho u^* y}{\mu} \right] + B = \frac{1}{0.41} \ln \left[ \frac{789(0.133)(0.04)}{0.0012} \right] + 5.0 = 24.9$$

Then  $u \approx 24.9(0.133) \approx 3.3 \text{ m/s}$  at  $r = 1 \text{ cm}$ . *Ans.* (c)

**6.67** A straight 10-cm commercial-steel pipe is 1 km long and is laid on a constant slope of  $5^\circ$ . Water at  $20^\circ\text{C}$  flows downward, due to gravity only. Estimate the flow rate in  $\text{m}^3/\text{h}$ . What happens if the pipe length is 2 km?

**Solution:** For water at  $20^\circ\text{C}$ , take  $\rho = 998 \text{ kg/m}^3$  and  $\mu = 0.001 \text{ kg/m}\cdot\text{s}$ . If the flow is due to gravity only, then the head loss exactly balances the elevation change:

$$h_f = \Delta z = L \sin \theta = f \frac{L V^2}{d 2g}, \quad \text{or} \quad f V^2 = 2gd \sin \theta = 2(9.81)(0.1) \sin 5^\circ \approx 0.171$$

Thus the flow rate is independent of the pipe length  $L$  if laid on a constant slope. *Ans.*  
 For commercial steel, take  $\varepsilon \approx 0.046 \text{ mm}$ , or  $\varepsilon/d \approx 0.00046$ . Begin by guessing fully-rough flow for the friction factor, and iterate  $V$  and  $Re$  and  $f$ :

$$f \approx 0.0164, \quad V \approx \left( \frac{0.171}{0.0164} \right)^{1/2} \approx 3.23 \frac{\text{m}}{\text{s}}, \quad Re = \frac{998(3.23)(0.1)}{0.001} \approx 322000$$

$$f_{\text{better}} \approx 0.0179, \quad V_{\text{better}} \approx 3.09 \text{ m/s}, \quad Re \approx 308000 \text{ (converged)}$$

$$\text{Then } Q \approx (\pi/4)(0.1)^2(3.09) \approx 0.0243 \text{ m}^3/\text{s} \approx 87 \text{ m}^3/\text{h}. \quad \textit{Ans.}$$

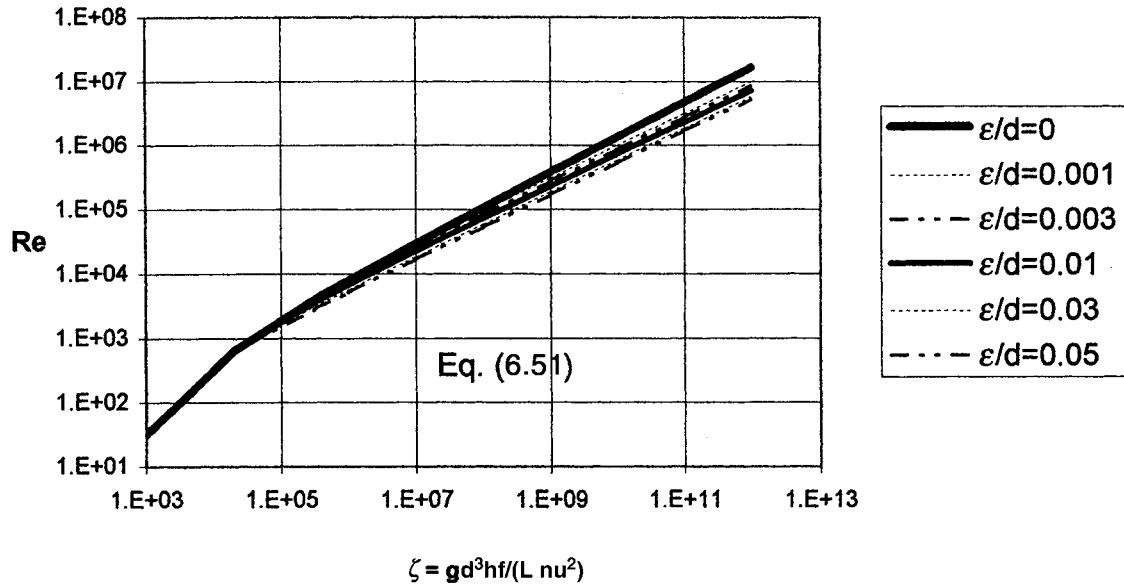
**6.68** The Moody chart, Fig. 6.13, is best for finding head loss (or  $\Delta p$ ) when  $Q$ ,  $V$ ,  $d$ , and  $L$  are known. It is awkward for the “2nd” type of problem, finding  $Q$  when  $h_f$  or  $\Delta p$  are known (see Ex. 6.9). Prepare a modified Moody chart whose abscissa is independent of  $Q$  and  $V$ , using  $\varepsilon/d$  as a parameter, from which one can immediately read the ordinate to find (dimensionless)  $Q$  or  $V$ . Use your chart to solve Example 6.9.

**Solution:** This problem was mentioned *analytically* in the text as Eq. (6.51). The proper parameter which contains head loss only, and *not* flow rate, is  $\zeta$ :

$$\zeta = \frac{gd^3 h_f}{LV^2} \quad Re_d = -(8\zeta)^{1/2} \log \left( \frac{\varepsilon/d}{3.7} + \frac{1.775}{\sqrt{\zeta}} \right) \quad \text{Eq. (6.51)}$$



We simply plot Reynolds number versus  $\zeta$  for various  $\varepsilon/d$ , as shown below:



To solve Example 6.9, a 100-m-long, 30-cm-diameter pipe with a head loss of 8 m and  $\varepsilon/d = 0.0002$ , we use that data to compute  $\zeta = 5.3E7$ . The oil properties are  $\rho = 950 \text{ kg/m}^3$  and  $\nu = 2E-5 \text{ m}^2/\text{s}$ . Enter the chart above: let's face it, the scale is very hard to read, but we estimate, at  $\zeta = 5.3E7$ , that  $6E4 < Re_d < 9E4$ , which translates to a flow rate of  $0.28 < Q < 0.42 \text{ m}^3/\text{s}$ . *Ans.* (Example 6.9 gave  $Q = 0.342 \text{ m}^3/\text{s}$ .)

**6.69** For Prob. 6.62 suppose the only pump available can deliver only 80 hp to the fluid. What is the proper pipe size in inches to maintain the  $3 \text{ ft}^3/\text{s}$  flow rate?

**Solution:** For water at  $20^\circ\text{C}$ , take  $\rho = 1.94 \text{ slug/ft}^3$  and  $\mu = 2.09E-5 \text{ slug/ft}\cdot\text{s}$ . For cast iron, take  $\varepsilon \approx 0.00085 \text{ ft}$ . We can't specify  $\varepsilon/d$  because we don't know  $d$ . The energy analysis above is correct and should be modified to replace  $V$  by  $Q$ :

$$h_p = 120 + f \frac{L}{d} \frac{(4Q/\pi d^2)^2}{2g} = 120 + f \frac{2000}{d} \frac{[4(3.0)/\pi d^2]^2}{2(32.2)} = 120 + 453 \frac{f}{d^5}$$

$$\text{But also } h_p = \frac{\text{Power}}{\rho g Q} = \frac{80(550)}{62.4(3.0)} = 235 = 120 + \frac{453 f}{d^5}, \quad \text{or: } d^5 \approx 3.94f$$

Guess  $f \approx 0.02$ , calculate  $d$ ,  $\varepsilon/d$  and  $Re$  and get a better  $f$  and iterate:

$$f \approx 0.020, \quad d \approx [3.94(0.02)]^{1/5} \approx 0.602 \text{ ft}, \quad Re = \frac{4\rho Q}{\pi\mu d} = \frac{4(1.94)(3.0)}{\pi(2.09E-5)(0.602)},$$

$$\text{or } Re \approx 589000, \quad \frac{\varepsilon}{d} = \frac{0.00085}{0.602} \approx 0.00141, \quad \text{Moody chart: } f_{\text{better}} \approx 0.0218 \text{ (repeat)}$$

We are nearly converged. The final solution is  $f \approx 0.0217$ ,  $d \approx 0.612 \text{ ft} \approx \mathbf{7.3 \text{ in}}$  *Ans.*

**6.70** In Prob. 6.62 suppose the pipe is 6-inch-diameter cast iron and the pump delivers 75 hp to the flow. What flow rate  $Q$  in  $\text{ft}^3/\text{s}$  results?

**Solution:** For water at  $20^\circ\text{C}$ , take  $\rho = 1.94 \text{ slug/ft}^3$  and  $\mu = 2.09E-5 \text{ slug/ft}\cdot\text{s}$ . For cast iron, take  $\varepsilon \approx 0.00085 \text{ ft}$ , or  $\varepsilon/d = 0.00085/(6/12) \approx 0.0017$ . The energy analysis holds:

$$\text{Power} = \rho g Q h_p = 62.4Q \left\{ 120 + f \left( \frac{2000}{6/12} \right) \frac{[4Q/\pi(6/12)^2]^2}{2(32.2)} \right\} = 75(550) \frac{\text{ft}\cdot\text{lbf}}{\text{s}}$$

Clean up:  $661 \approx Q(120 + 1611Q^2f)$ , solve by iteration using  $\varepsilon/d$  and  $Re$

Guess  $f \approx 0.02$ ,  $Q \approx 2.29 \text{ ft}^3/\text{s}$ ,  $Re = 4\rho Q/\pi\mu d \approx 541000$ , then  $f_{\text{better}} \approx 0.0228$

Convergence is near:  $f \approx 0.02284$ ,  $Re \approx 522000$ ,  $\mathbf{Q \approx 2.21 \text{ ft}^3/\text{s}}$ . *Ans.*

**6.71** It is desired to solve Prob. 6.62 for the most economical pump and cast-iron pipe system. If the pump costs \$125 per horsepower delivered to the fluid and the pipe costs \$7000 per inch of diameter, what are the minimum cost and the pipe and pump size to maintain the  $3 \text{ ft}^3/\text{s}$  flow rate? Make some simplifying assumptions.

**Solution:** For water at  $20^\circ\text{C}$ , take  $\rho = 1.94 \text{ slug/ft}^3$  and  $\mu = 2.09E-5 \text{ slug/ft}\cdot\text{s}$ . For cast iron, take  $\varepsilon \approx 0.00085 \text{ ft}$ . Write the energy equation (from Prob. 6.62) in terms of  $Q$  and  $d$ :

$$P_{\text{in hp}} = \frac{\rho g Q}{550} (\Delta z + h_f) = \frac{62.4(3.0)}{550} \left\{ 120 + f \left( \frac{2000}{d} \right) \frac{[4(3.0)/\pi d^2]^2}{2(32.2)} \right\} = 40.84 + \frac{154.2f}{d^5}$$

$$\text{Cost} = \$125P_{\text{hp}} + \$7000d_{\text{inches}} = 125(40.84 + 154.2f/d^5) + 7000(12d), \quad \text{with } d \text{ in ft.}$$

$$\text{Clean up: } \text{Cost} \approx \$5105 + 19278f/d^5 + 84000d$$

Regardless of the (unknown) value of  $f$ , this Cost relation does show a minimum. If we assume for simplicity that  $f$  is constant, we may use the differential calculus:

$$\frac{d(\text{Cost})}{d(d)} \Big|_{f \approx \text{const}} = \frac{-5(19278)f}{d^6} + 84000, \quad \text{or} \quad d_{\text{best}} \approx (1.148 f)^{1/6}$$

$$\text{Guess } f \approx 0.02, \quad d \approx [1.148(0.02)]^{1/6} \approx 0.533 \text{ ft}, \quad \text{Re} = \frac{4\rho Q}{\pi\mu d} \approx 665000, \quad \frac{\varepsilon}{d} \approx 0.00159$$

$$\text{Then } f_{\text{better}} \approx 0.0224, \quad d_{\text{better}} \approx 0.543 \text{ ft (converged)}$$

Result:  $d_{\text{best}} \approx 0.543 \text{ ft} \approx \mathbf{6.5 \text{ in}}$ ,  $\text{Cost}_{\text{min}} \approx \$14300_{\text{pump}} + \$45600_{\text{pipe}} \approx \mathbf{\$60000}$ . *Ans.*

**6.72** Modify Prob. P6.57 by letting the diameter be unknown. Find the proper pipe diameter for which the pool will drain in about 2 hours flat.

**Solution:** Recall the data: Let  $W = 5 \text{ m}$ ,  $Y = 8 \text{ m}$ ,  $h_o = 2 \text{ m}$ ,  $L = 15 \text{ m}$ , and  $\varepsilon = 0$ , with water,  $\rho = 998 \text{ kg/m}^3$  and  $\mu = 0.001 \text{ kg/m}\cdot\text{s}$ . We apply the same theory as Prob. 6.57:

$$V = \sqrt{\frac{2gh}{1 + fL/D}}, \quad t_{\text{drain}} \approx \frac{4WY}{\pi D^2} \sqrt{\frac{2h_o(1 + f_{\text{av}}L/D)}{g}}, \quad f_{\text{av}} = f_{\text{cn}}(\text{Re}_D) \quad \text{for a smooth pipe.}$$

For the present problem,  $t_{\text{drain}} = 2 \text{ hours}$  and  $D$  is the unknown. Use an average value  $h = 1 \text{ m}$  to find  $f_{\text{av}}$ . Enter these equations on EES (or you can iterate by hand) and the final results are

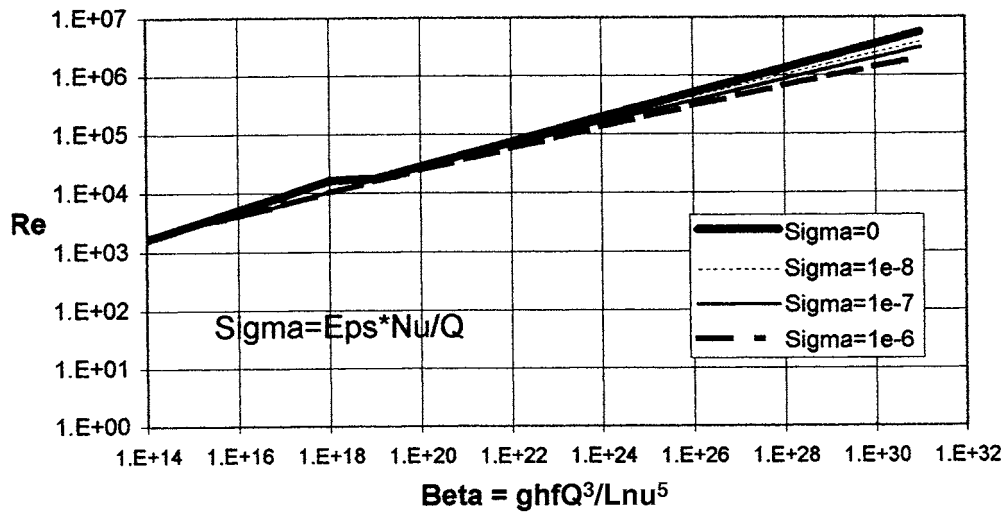
$$V = 2.36 \text{ m/s}; \quad \text{Re}_D = 217,000; \quad f_{\text{av}} \approx 0.0154; \quad D = 0.092 \text{ m} \approx \mathbf{9.2 \text{ cm}} \quad \text{Ans.}$$

**6.73** The Moody chart, Fig. 6.13, is best for finding head loss (or  $\Delta p$ ) when  $Q$ ,  $V$ ,  $d$ , and  $L$  are known. It is awkward for the “3rd” type of problem, finding  $d$  when  $h_f$  (or  $\Delta p$ ) and  $Q$  are known (see Ex. 6.11). Prepare a modified Moody chart whose abscissa is independent of  $d$ , using as a parameter  $\varepsilon$  non-dimensionalized without  $d$ , from which one can immediately read the (dimensionless) ordinate to find  $d$ . Use your chart to solve Ex. 6.11.

**Solution:** An appropriate Pi group which does not contain  $d$  is  $\beta = (gh_f Q^3)/(L V^5)$ . Similarly, an appropriate roughness parameter without  $d$  is  $\sigma = (\varepsilon V/Q)$ . After a lot of algebra, the Colebrook friction factor formula (6.48) becomes

$$\text{Re}_d^{5/2} = -2.0 \left( \frac{128\beta}{\pi^3} \right)^{1/2} \log_{10} \left[ \frac{\pi\sigma \text{Re}_d}{14.8} + \frac{2.51 \text{Re}_d^{3/2}}{(128\beta/\pi^3)^{1/2}} \right]$$

A plot of this messy relation is given below.



To solve Example 6.11, a 100-m-long, unknown-diameter pipe with a head loss of 8 m, flow rate of  $0.342 \text{ m}^3/\text{s}$ , and  $\varepsilon = 0.06 \text{ mm}$ , we use that data to compute  $\beta = 9.8\text{E}21$  and  $\sigma = 3.5\text{E}-6$ . The oil properties are  $\rho = 950 \text{ kg/m}^3$  and  $\nu = 2\text{E}-5 \text{ m}^2/\text{s}$ . Enter the chart above: let's face it, the scale is very hard to read, but we estimate, at  $\beta = 9.8\text{E}21$  and  $\sigma = 3.5\text{E}-6$ , that  $6\text{E}4 < \text{Re}_d < 8\text{E}4$ , which translates to a diameter of  $0.27 < d < 0.36 \text{ m}$ . *Ans.* (Example 6.11 gave  $d = 0.3 \text{ m}$ .)

**6.74** In Fig. P6.67 suppose the fluid is **gasoline** at  $20^\circ\text{C}$  and  $h = 90 \text{ ft}$ . What commercial-steel pipe diameter is required for the flow rate to be  $0.015 \text{ ft}^3/\text{s}$ ?

**Solution:** For commercial steel, take  $\varepsilon \approx 0.00015 \text{ ft}$ . For gasoline, take  $\rho = 1.32 \text{ slug/ft}^3$  and  $\mu = 6.1\text{E}-6 \text{ slug/ft}\cdot\text{s}$ . From Prob. 6.61 the energy relation gives

$$h = \frac{V^2}{2g} + h_f = \frac{(4Q/\pi d^2)^2}{2g} \left( 1 + f \frac{L}{d} \right), \quad \text{or:} \quad 90 \text{ ft} = \frac{[4(0.015)/\pi d^2]^2}{2(32.2)} \left\{ 1 + f \frac{80}{d} \right\}$$

$$\text{Clean up: } d \approx 0.0158(1 + 80f/d)^{1/4} \quad \text{with } f \text{ determined from } \text{Re} \text{ and } \frac{\varepsilon}{d} = \frac{0.00015}{d}$$

Because  $d$  appears implicitly in two places, considerable iteration is required:

$$\text{Guess } f \approx 0.02, \quad d \approx 0.0158[1 + 80(0.02)/d]^{1/4} \approx 0.0401 \text{ ft},$$

$$\text{Re} = \frac{4\rho Q}{\pi\mu d} = \frac{4(1.32)(0.015)}{\pi(6.1\text{E}-6)(0.0401)} \approx 103000, \quad \frac{\varepsilon}{d} \approx 0.00374, \quad f_{\text{better}} \approx 0.0290$$

Converges to  $f \approx 0.0290$ ,  $\text{Re} \approx 96000$ ,  $d \approx 0.0431 \text{ ft} \approx \mathbf{0.52 \text{ inches}}$  *Ans.*

**6.75** You wish to water your garden with 100 ft of  $\frac{5}{8}$ -in-diameter hose whose roughness is 0.011 in. What will be the delivery, in  $\text{ft}^3/\text{s}$ , if the gage pressure at the faucet is  $60 \text{ lbf/in}^2$ ? If there is no nozzle (just an open hose exit), what is the maximum horizontal distance the exit jet will carry?

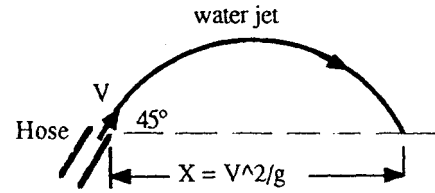


Fig. P6.75

**Solution:** For water, take  $\rho = 1.94 \text{ slug/ft}^3$  and  $\mu = 2.09\text{E-}5 \text{ slug/ft}\cdot\text{s}$ . We are given  $\varepsilon/d = 0.011/(5/8) \approx 0.0176$ . For constant area hose,  $V_1 = V_2$  and energy yields

$$\frac{P_{\text{faucet}}}{\rho g} = h_f, \quad \text{or:} \quad \frac{60 \times 144 \text{ psf}}{1.94(32.2)} = 138 \text{ ft} = f \frac{L}{d} \frac{V^2}{2g} = f \frac{100}{(5/8)/12} \frac{V^2}{2(32.2)},$$

$$\text{or } fV^2 \approx 4.64. \quad \text{Guess } f \approx f_{\text{fully rough}} = 0.0463, \quad V \approx 10.0 \frac{\text{ft}}{\text{s}}, \quad \text{Re} \approx 48400$$

$$\text{then } f_{\text{better}} \approx 0.0472, \quad V_{\text{final}} \approx \mathbf{9.91 \text{ ft/s}} \text{ (converged)}$$

$$\text{The hose delivery then is } Q = (\pi/4)(5/8/12)^2(9.91) = \mathbf{0.0211 \text{ ft}^3/\text{s}}. \quad \text{Ans. (a)}$$

From elementary particle-trajectory theory, the maximum horizontal distance  $X$  travelled by the jet occurs at  $\theta = 45^\circ$  (see figure) and is  $X = V^2/g = (9.91)^2/(32.2) \approx \mathbf{3.05 \text{ ft}}$  Ans. (b), which is pitiful. You need a *nozzle* on the hose to increase the exit velocity.

**6.76** The small turbine in Fig. P6.76 extracts 400 W of power from the water flow. Both pipes are wrought iron. Compute the flow rate  $Q \text{ m}^3/\text{h}$ . Sketch the EGL and HGL accurately.

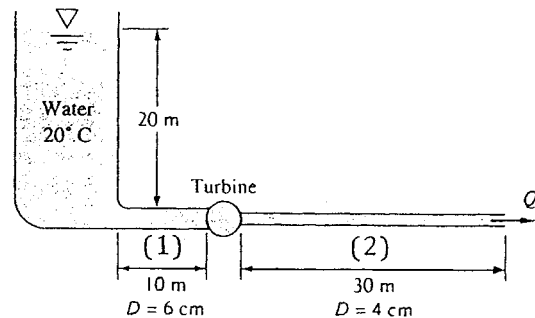


Fig. P6.76

**Solution:** For water, take  $\rho = 998 \text{ kg/m}^3$  and  $\mu = 0.001 \text{ kg/m}\cdot\text{s}$ . For wrought iron, take  $\varepsilon \approx 0.046 \text{ mm}$ , hence  $\varepsilon/d_1 = 0.046/60 \approx 0.000767$  and  $\varepsilon/d_2 = 0.046/40 \approx 0.00115$ . The energy equation, with  $V_1 \approx 0$  and  $p_1 = p_2$ , gives

$$z_1 - z_2 = 20 \text{ m} = \frac{V_2^2}{2g} + h_{f2} + h_{f1} + h_{\text{turbine}}, \quad h_{f1} = f_1 \frac{L_1}{d_1} \frac{V_1^2}{2g} \quad \text{and} \quad h_{f2} = f_2 \frac{L_2}{d_2} \frac{V_2^2}{2g}$$

$$\text{Also, } h_{\text{turbine}} = \frac{P}{\rho g Q} = \frac{400 \text{ W}}{998(9.81)Q} \quad \text{and} \quad Q = \frac{\pi}{4} d_1^2 V_1 = \frac{\pi}{4} d_2^2 V_2$$

The only unknown is  $Q$ , which we may determine by iteration after an initial guess:

$$h_{\text{turb}} = \frac{400}{998(9.81)Q} = 20 - \frac{8f_1L_1Q^2}{\pi^2gd_1^5} - \frac{8f_2L_2Q^2}{\pi^2gd_2^5} - \frac{8Q^2}{\pi^2gd_2^4}$$

Guess  $Q = 0.003 \frac{\text{m}^3}{\text{s}}$ , then  $\text{Re}_1 = \frac{4\rho Q}{\pi\mu d_1} = 63500$ ,  $f_{1,\text{Moody}} \approx 0.0226$ ,

$$\text{Re}_2 = 95300, \quad f_2 \approx 0.0228.$$

But, for this guess,  $h_{\text{turb}}$ (left hand side)  $\approx 13.62$  m,  $h_{\text{turb}}$ (right hand side)  $\approx 14.53$  m (wrong). Other guesses converge to  $h_{\text{turb}} \approx 9.9$  meters. For  $Q \approx 0.00413 \text{ m}^3/\text{s} \approx \mathbf{15 \text{ m}^3/\text{h}}$ . *Ans.*

**6.77** Modify Prob. 6.76 into an economic analysis, as follows. Let the 40 m of wrought-iron pipe have a uniform diameter  $d$ . Let the steady water flow available be  $Q = 30 \text{ m}^3/\text{h}$ . The cost of the turbine is \$4 per watt developed, and the cost of the piping is \$75 per centimeter of diameter. The power generated may be sold for \$0.08 per kilowatt hour. Find the proper pipe diameter for minimum *payback time*, i.e., minimum time for which the power sales will equal the initial cost of the system.

**Solution:** With flow rate known, we need only guess a diameter and compute power from the energy equation similar to Prob. 6.76:

$$P = \rho g Q h_t, \quad \text{where } h_t = 20 \text{ m} - \frac{V^2}{2g} \left( 1 + f \frac{L}{d} \right) = 20 - \frac{8Q^2}{\pi^2 g d^4} \left( 1 + f \frac{L}{d} \right)$$

$$\text{Then Cost} = \$4 * P + \$75(100d) \quad \text{and} \quad \text{Annual income} = \$0.08 \left( \frac{P}{1000} \right) (24)(365)$$

The Moody friction factor is computed from  $\text{Re} = 4\rho Q/(\pi\mu d)$  and  $\epsilon/d = 0.066/d(\text{mm})$ . The payback time, in years, is then the cost divided by the annual income. For example,

$$\text{If } d = 0.1 \text{ m}, \quad \text{Re} \approx 106000, \quad f \approx 0.0200, \quad h_t \approx 19.48 \text{ m}, \quad P = 1589.3 \text{ W}$$

$$\text{Cost} \approx \$7107 \quad \text{Income} = \$1,114/\text{year} \quad \text{Payback} \approx \mathbf{6.38 \text{ years}}$$

Since the piping cost is very small ( $< \$1000$ ), both cost and income are nearly proportional to power, hence the payback will be nearly the same (6.38 years) regardless of diameter. There is an almost invisible minimum at  $\mathbf{d \approx 7 \text{ cm}}$ ,  $\text{Re} \approx 151000$ ,  $f \approx 0.0201$ ,  $h_t \approx 17.0$  m,  $\text{Cost} \approx \$6078$ ,  $\text{Income} \approx \$973$ ,  $\text{Payback} \approx 6.25$  years. However, as diameter  $d$  decreases, we generate less power and gain little in payback time.

**6.78** In Fig. P6.78 the connecting pipe is commercial steel 6 cm in diameter. Estimate the flow rate, in  $\text{m}^3/\text{h}$ , if the fluid is water at  $20^\circ\text{C}$ . Which way is the flow?

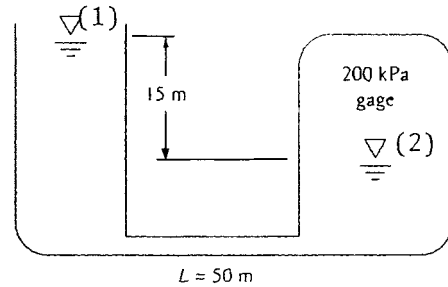


Fig. P6.78

**Solution:** For water, take  $\rho = 998 \text{ kg/m}^3$  and  $\mu = 0.001 \text{ kg/m}\cdot\text{s}$ . For commercial steel, take  $\varepsilon \approx 0.046 \text{ mm}$ , hence  $\varepsilon/d = 0.046/60 \approx 0.000767$ . With  $p_1$ ,  $V_1$ , and  $V_2$  all  $\approx 0$ , the energy equation between surfaces (1) and (2) yields

$$0 + 0 + z_1 \approx \frac{p_2}{\rho g} + 0 + z_2 + h_f, \quad \text{or} \quad h_f = 15 - \frac{200000}{998(9.81)} \approx -5.43 \text{ m (flow to left)} \leftarrow$$

$$\text{Guess turbulent flow: } h_f = f \frac{L}{d} \frac{V^2}{2g} = f \frac{50}{0.06} \frac{V^2}{2(9.81)} = 5.43, \quad \text{or: } fV^2 \approx 0.1278$$

$$\frac{\varepsilon}{d} = 0.00767, \quad \text{guess } f_{\text{fully rough}} \approx 0.0184, \quad V \approx \left( \frac{0.1278}{0.0184} \right)^{1/2} \approx 2.64 \frac{\text{m}}{\text{s}}, \quad \text{Re} = 158000$$

$$f_{\text{better}} \approx 0.0204, \quad V_{\text{better}} = 2.50 \frac{\text{m}}{\text{s}}, \quad \text{Re}_{\text{better}} \approx 149700, \quad f_{\text{3rd iteration}} \approx 0.0205 \text{ (converged)}$$

The iteration converges to

$$f \approx 0.0205, \quad V \approx 2.49 \text{ m/s}, \quad Q = (\pi/4)(0.06)^2(2.49) = 0.00705 \text{ m}^3/\text{s} = \mathbf{25 \text{ m}^3/\text{h}} \leftarrow \text{Ans.}$$

**6.79** A garden hose is used as the return line in a waterfall display at the mall. In order to select the proper pump, you need to know the hose wall roughness, which is not supplied by the manufacturer. You devise a simple experiment: attach the hose to the drain of an above-ground pool whose surface is 3 m above the hose outlet. You estimate the minor loss coefficient in the entrance region as 0.5, and the drain valve has a minor-loss equivalent length of 200 diameters when fully open. Using a bucket and stopwatch, you open the valve and measure a flow rate of  $2.0\text{E-}4 \text{ m}^3/\text{s}$  for a hose of inside diameter 1.5 cm and length 10 m. Estimate the roughness height of the hose inside surface.

**Solution:** First evaluate the average velocity in the hose and its Reynolds number:

$$V = \frac{Q}{A} = \frac{2.0\text{E-}4}{(\pi/4)(0.015)^2} = 1.13 \frac{\text{m}}{\text{s}}, \quad \text{Re}_d = \frac{\rho V d}{\mu} = \frac{998(1.13)(0.015)}{0.001} = 16940 \text{ (turbulent)}$$

Write the energy equation from surface (point 1) to outlet (point 2), assuming an energy correction factor  $\alpha = 1.05$ :

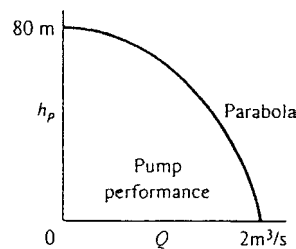
$$\frac{p_1}{\rho g} + \frac{\alpha_1 V_1^2}{2g} + z_1 = \frac{p_2}{\rho g} + \frac{\alpha_2 V_2^2}{2g} + z_2 + h_f + \sum h_{loss}, \quad \text{where } \sum h_{loss} = \left( K_e + f \frac{L_{eq}}{d} \right) \frac{\alpha_2 V_2^2}{2g}$$

The unknown is the friction factor:

$$f = \frac{\frac{z_1 - z_2}{V^2/2g} - \alpha_2 - K_e}{(L + L_{eq})/d} = \frac{\frac{3\text{m}}{(1.13)^2/2(9.81)} - 1.05 - 0.5}{(10/0.015 + 200)} = 0.0514$$

For  $f = 0.0514$  and  $Re_d = 16940$ , the Moody chart (Eq. 6.48) predicts  $\varepsilon/d \approx 0.0206$ . Therefore the estimated hose-wall roughness is  $\varepsilon = 0.0206(1.5 \text{ cm}) = \mathbf{0.031 \text{ cm}}$  *Ans.*

**6.80** The head-versus-flow-rate characteristics of a centrifugal pump are shown in Fig. P6.80. If this pump drives water at 20°C through 120 m of 30-cm-diameter cast-iron pipe, what will be the resulting flow rate, in  $\text{m}^3/\text{s}$ ?



**Fig. P6.80**

**Solution:** For water, take  $\rho = 998 \text{ kg/m}^3$  and  $\mu = 0.001 \text{ kg/m}\cdot\text{s}$ . For cast iron, take  $\varepsilon \approx 0.26 \text{ mm}$ , hence  $\varepsilon/d = 0.26/300 \approx 0.000867$ .

The head loss must match the pump head:

$$h_f = f \frac{L}{d} \frac{V^2}{2g} = \frac{8fLQ^2}{\pi^2 g d^5} = h_{\text{pump}} \approx 80 - 20Q^2, \quad \text{with } Q \text{ in } \text{m}^3/\text{s}$$

$$\text{Evaluate } h_f = \frac{8f(120)Q^2}{\pi^2 (9.81)(0.3)^5} = 80 - 20Q^2, \quad \text{or: } Q^2 \approx \frac{80}{20 + 4080f}$$

$$\text{Guess } f \approx 0.02, \quad Q = \left[ \frac{80}{20 + 4080(0.02)} \right]^{1/2} \approx 0.887 \frac{\text{m}^3}{\text{s}}, \quad Re = \frac{4\rho Q}{\pi\mu d} \approx 3.76\text{E}6$$

$$\frac{\varepsilon}{d} = 0.000867, \quad f_{\text{better}} \approx 0.0191, \quad Re_{\text{better}} \approx 3.83\text{E}6, \quad \text{converges to } Q \approx \mathbf{0.905 \frac{\text{m}^3}{\text{s}}} \quad \text{Ans.}$$



**6.81** The pump in Fig. P6.80 is used to deliver gasoline at 20°C through 350 m of 30-cm-diameter galvanized iron pipe. Estimate the resulting flow rate, in m<sup>3</sup>/s. (Note that the pump head is now in meters of gasoline.)

**Solution:** For gasoline, take  $\rho = 680 \text{ kg/m}^3$  and  $\mu = 2.92\text{E-}4 \text{ kg/m}\cdot\text{s}$ . For galvanized iron, take  $\varepsilon \approx 0.15 \text{ mm}$ , hence  $\varepsilon/d = 0.15/300 \approx 0.0005$ . Head loss matches pump head:

$$h_f = \frac{8fLQ^2}{\pi^2 g d^5} = \frac{8f(350)Q^2}{\pi^2 (9.81)(0.3)^5} = 11901fQ^2 = h_{\text{pump}} \approx 80 - 20Q^2, \quad Q^2 = \frac{80}{20 + 11901f}$$

$$\text{Guess } f_{\text{rough}} \approx 0.017, \quad Q \approx 0.600 \frac{\text{m}^3}{\text{s}},$$

$$\text{Re}_{\text{better}} \approx 5.93\text{E}6, \quad \frac{\varepsilon}{d} = 0.0005, \quad f_{\text{better}} \approx 0.0168$$

This converges to  $f \approx 0.0168$ ,  $\text{Re} \approx 5.96\text{E}6$ ,  $\mathbf{Q \approx 0.603 \text{ m}^3/\text{s}}$ . *Ans.*

---

**6.82** The pump in Fig. P6.80 has its maximum efficiency at a head of 45 m. If it is used to pump ethanol at 20°C through 200 m of commercial-steel pipe, what is the proper pipe diameter for maximum pump efficiency?

**Solution:** For ethanol, take  $\rho = 789 \text{ kg/m}^3$  and  $\mu = 1.2\text{E-}3 \text{ kg/m}\cdot\text{s}$ . For commercial steel, take  $\varepsilon \approx 0.046 \text{ mm}$ , hence  $\varepsilon/d = 0.046/(1000d)$ . We know the head and flow rate:

$$h_{\text{pump}} = 45 \text{ m} \approx 80 - 20Q^2, \quad \text{solve for } Q \approx 1.323 \text{ m}^3/\text{s}.$$

$$\text{Then } h_p = h_f = \frac{8fLQ^2}{\pi^2 g d^5} = \frac{8f(200)(1.323)^2}{\pi^2 (9.81)d^5} = \frac{28.92f}{d^5} = 45 \text{ m}, \quad \text{or: } d \approx 0.915f^{1/5}$$

$$\text{Guess } f \approx 0.02, \quad d \approx 0.915(0.02)^{1/5} \approx 0.419 \text{ m},$$

$$\text{Re} = \frac{4\rho Q}{\pi\mu d} \approx 2.6\text{E}6, \quad \frac{\varepsilon}{d} \approx 0.000110$$

$$\text{Then } f_{\text{better}} \approx 0.0130, \quad d_{\text{better}} \approx 0.384 \text{ m}, \quad \text{Re}_{\text{better}} \approx 2.89\text{E}6, \quad \left. \frac{\varepsilon}{d} \right|_{\text{better}} \approx 0.000120$$

This converges to  $f \approx 0.0129$ ,  $\text{Re} \approx 2.89\text{E}6$ ,  $\mathbf{d \approx 0.384 \text{ m}}$ . *Ans.*

---

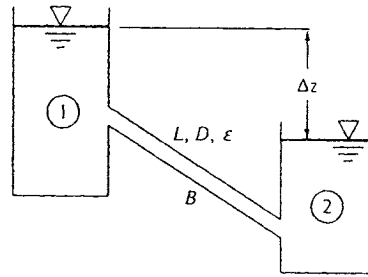
**6.83** For the system of Fig. P6.55, let  $\Delta z = 80$  m and  $L = 185$  m of cast-iron pipe. What is the pipe diameter for which the flow rate will be  $7 \text{ m}^3/\text{h}$ ?

**Solution:** For water, take  $\rho = 998 \text{ kg/m}^3$  and  $\mu = 0.001 \text{ kg/m}\cdot\text{s}$ . For cast iron, take  $\varepsilon \approx 0.26 \text{ mm}$ , but  $d$  is unknown. The energy equation is simply

$$\Delta z = 80 \text{ m} = h_f = \frac{8fLQ^2}{\pi^2 g d^5} = \frac{8f(185)(7/3600)^2}{\pi^2 (9.81)d^5} = \frac{5.78\text{E-}5 f}{d^5}, \quad \text{or} \quad d \approx 0.0591 f^{1/5}$$

$$\text{Guess } f \approx 0.03, \quad d = 0.0591(0.03)^{1/5} \approx 0.0293 \text{ m}, \quad \text{Re} = \frac{4\rho Q}{\pi\mu d} \approx 84300, \quad \frac{\varepsilon}{d} \approx 0.00887$$

Iterate:  $f_{\text{better}} \approx 0.0372$ ,  $d_{\text{better}} \approx 0.0306 \text{ m}$ ,  $\text{Re}_{\text{better}} \approx 80700$ ,  $\varepsilon/d|_{\text{better}} \approx 0.00850$ , etc. The process converges to  $f \approx 0.0367$ ,  $d \approx \mathbf{0.0305 \text{ m}}$ . *Ans.*



**Fig. P6.55**

**6.84** It is desired to deliver  $60 \text{ m}^3/\text{h}$  of water ( $\rho = 998 \text{ kg/m}^3$ ,  $\mu = 0.001 \text{ kg/m}\cdot\text{s}$ ) at  $20^\circ\text{C}$  through a horizontal asphalted cast-iron pipe. Estimate the pipe diameter which will cause the pressure drop to be exactly  $40 \text{ kPa}$  per  $100$  meters of pipe length.

**Solution:** Write out the relation between  $\Delta p$  and friction factor, taking “ $L$ ” =  $100$  m:

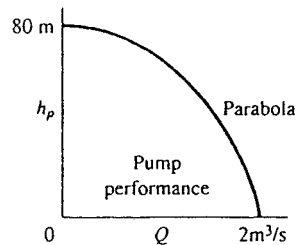
$$\Delta p = f \frac{L}{d} \frac{\rho}{2} V^2 = f \frac{100}{d} \frac{(998)}{2} \left[ \frac{60/3600}{(\pi/4)d^2} \right]^2 = 40,000 = 22.48 \frac{f}{d^5}, \quad \text{or: } d^5 = 0.00562f$$

Knowing  $\varepsilon = 0.12 \text{ mm}$ , then  $\varepsilon/d = 0.00012/d$  and  $\text{Re}_d = 4\rho Q/(\pi\mu d) = 21178/d$ . Use EES, or guess  $f \approx 0.02$  and iterate until the proper diameter and friction factor are found.

Final convergence:  $f \approx 0.0216$ ;  $\text{Re}_d \approx 204,000$ ;  $d = \mathbf{0.104 \text{ m}}$ . *Ans.*

**6.85** The pump of Fig. P6.80 is used to deliver  $0.7 \text{ m}^3/\text{s}$  of methanol at  $20^\circ\text{C}$  through  $95$  m of cast-iron pipe. What is the proper pipe diameter?

**Solution:** For methanol, take  $\rho = 791 \text{ kg/m}^3$  and  $\mu = 5.98\text{E-}4 \text{ kg/m}\cdot\text{s}$ . For cast iron, take



**Fig. P6.80**

$\varepsilon \approx 0.26$  mm, hence  $\varepsilon/d = 0.26/(1000d)$  with  $d$  unknown. Head loss must match pump head:

$$h_f = \frac{8fLQ^2}{\pi^2 g d^5} = \frac{8f(95)(0.7)^2}{\pi^2 (9.81)d^5} = \frac{3.85f}{d^5} = h_{\text{pump}} \approx 80 - 20Q^2 = 80 - 20(0.7)^2 \approx 70.2 \text{ m},$$

$$\text{or: } d \approx 0.559f^{1/5}. \quad \text{Guess } f \approx 0.02, \quad d \approx 0.559(0.02)^{1/5} \approx 0.256 \text{ m}$$

$$\text{Re} = 4\rho Q/(\pi\mu d) \approx 4.61\text{E}6, \quad \varepsilon/d = 0.26/[1000(0.256)] \approx 0.00102$$

Keep iterating:  $f_{\text{better}} \approx 0.0198$ ,  $d_{\text{better}} \approx 0.255$  m,  $\text{Re}_{\text{better}} \approx 4.62\text{E}6$ ,  $\varepsilon/d|_{\text{better}} \approx 0.00102$ , etc. The process converges to  $f \approx 0.0198$ ,  $d \approx \mathbf{0.255}$  m. *Ans.*

**6.86** SAE 10 oil at 20°C flows at an average velocity of 2 m/s between two smooth parallel horizontal plates 3 cm apart. Estimate (a) the centerline velocity, (b) the head loss per meter, and (c) the pressure drop per meter.

**Solution:** For SAE 10 oil, take  $\rho = 870$  kg/m<sup>3</sup> and  $\mu = 0.104$  kg/m·s. The half-distance between plates is called “ $h$ ” (see Fig. 6.37). Check  $D_h$  and  $\text{Re}$ :

$$D_h = \frac{4A}{P} = 4h = 6 \text{ cm}, \quad \text{Re}_{D_h} = \frac{\rho V D_h}{\mu} = \frac{870(2.0)(0.06)}{0.104} \approx 1004 \text{ (laminar)}$$

$$\text{Then } u_{\text{CL}} = u_{\text{max}} = \frac{3}{2}V = \frac{3}{2}(2.0) \approx \mathbf{3.0} \text{ m/s} \quad \text{Ans. (a)}$$

The head loss and pressure drop per meter follow from laminar theory, Eq. (6.63):

$$\Delta p = \frac{3\mu VL}{h^2} = \frac{3(0.104)(2.0)(1.0)}{(0.015 \text{ m})^2} \approx \mathbf{2770} \text{ Pa/m} \quad \text{Ans. (c)}$$

$$h_f = \frac{\Delta p}{\rho g} = \frac{2770}{870(9.81)} \approx \mathbf{0.325} \text{ m/m} \quad \text{Ans. (b)}$$

**6.87** A commercial-steel annulus 40 ft long, with  $a = 1$  in and  $b = \frac{1}{2}$  in, connects two reservoirs which differ in surface height by 20 ft. Compute the flow rate in ft<sup>3</sup>/s through the annulus if the fluid is water at 20°C.

**Solution:** For water, take  $\rho = 1.94 \text{ slug/ft}^3$  and  $\mu = 2.09\text{E-}5 \text{ slug/ft}\cdot\text{s}$ . For commercial steel, take  $\varepsilon \approx 0.00015 \text{ ft}$ . Compute the hydraulic diameter of the annulus:

$$D_h = \frac{4A}{P} = 2(a - b) = 1 \text{ inch};$$

$$h_f = 20 \text{ ft} = f \frac{L}{D_h} \frac{V^2}{2g} = f \left( \frac{40}{1/12} \right) \frac{V^2}{2(32.2)}, \quad \text{or: } fV^2 \approx 2.683$$

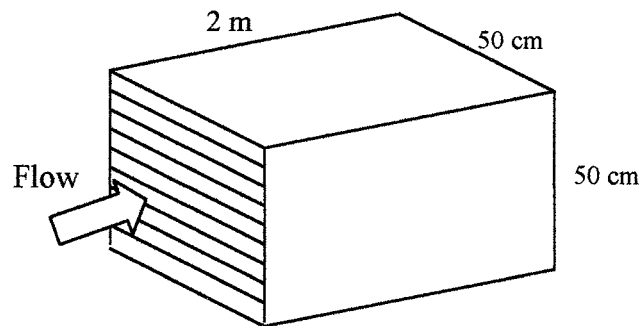
We can make a reasonable estimate by simply relating the Moody chart to  $D_h$ , rather than the more complicated “effective diameter” method of Eq. (6.77). Thus

$$\frac{\varepsilon}{D_h} = \frac{0.00015}{1/12} \approx 0.0018, \quad \text{Guess } f_{\text{rough}} \approx 0.023, \quad V = (2.683/0.023)^{1/2} \approx 10.8 \frac{\text{ft}}{\text{s}}$$

$$\text{Re} = \frac{\rho V D_h}{\mu} = \frac{1.94(10.8)(1/12)}{2.09\text{E-}5} \approx 83550, \quad f_{\text{better}} \approx 0.0249, \quad V_{\text{better}} \approx 10.4 \frac{\text{ft}}{\text{s}}$$

This converges to  $f \approx 0.0250$ ,  $V \approx 10.37 \text{ ft/s}$ ,  $Q = \pi(a^2 - b^2)V = \mathbf{0.17 \text{ ft}^3/\text{s}}$ . *Ans.*

**6.88** An oil cooler consists of multiple parallel-plate passages, as shown in Fig. P6.88. The available pressure drop is 6 kPa, and the fluid is SAE 10W oil at 20°C. If the desired total flow rate is 900 m<sup>3</sup>/h, estimate the appropriate number of passages. The plate walls are hydraulically smooth.



**Fig. P6.88**

**Solution:** For SAE 10W oil,  $\rho = 870 \text{ kg/m}^3$  and  $\mu = 0.104 \text{ kg/m}\cdot\text{s}$ . The pressure drop remains 6 kPa no matter how many passages there are (ducts in parallel). Guess laminar flow, Eq. (6.63),

$$Q_{\text{one passage}} = \frac{bh^3}{3\mu} \frac{\Delta p}{L}$$

where  $h$  is the half-thickness between plates. If there are  $N$  passages, then  $b = 50$  cm for all and  $h = 0.5$  m/( $2N$ ). We find  $h$  and  $N$  such that  $NQ = 900$  m<sup>3</sup>/h for the full set of passages. The problem is ideal for EES, but one can iterate with a calculator also. We find that 18 passages are one too many— $Q$  only equals 835 m<sup>3</sup>/h. The better solution is:

$$N = 17 \text{ passages, } Q_N = 935 \text{ m}^3/\text{h, } h = 1.47 \text{ cm, } Re_{D_h} = 512 \text{ (laminar flow)}$$

**6.89** An annulus of narrow clearance causes a very large pressure drop and is useful as an accurate measurement of viscosity. If a smooth annulus 1 m long with  $a = 50$  mm and  $b = 49$  mm carries an oil flow at 0.001 m<sup>3</sup>/s, what is the oil viscosity if the pressure drop is 250 kPa?

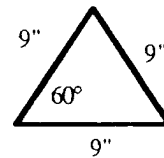
**Solution:** Assuming laminar flow, use Eq. (6.73) for the pressure drop and flow rate:

$$Q = \frac{\pi}{8\mu} \frac{\Delta p}{L} \left[ a^4 - b^4 - \frac{(a^2 - b^2)^2}{\ln(a/b)} \right], \text{ or, for the given data:}$$

$$0.001 \text{ m}^3/\text{s} = \frac{\pi}{8\mu} \left( \frac{250000}{1 \text{ m}} \right) \left[ (0.05)^4 - (0.049)^4 - \frac{\{(0.05)^2 - (0.049)^2\}^2}{\ln(0.05/0.049)} \right]$$

$$\text{Solve for } \mu \approx \mathbf{0.0065 \text{ kg/m}\cdot\text{s}} \text{ Ans.}$$

**6.90** A 90-ft-long sheet-steel duct carries air at approximately 20°C and 1 atm. The duct cross section is an equilateral triangle whose side measures 9 in. If a blower can supply 1 hp to the flow, what flow rate, in ft<sup>3</sup>/s, will result?



**Fig. P6.90**

**Solution:** For air at 20°C and 1 atm, take  $\rho \approx 0.00234$  slug/ft<sup>3</sup> and  $\mu = 3.76\text{E-}7$  slug/ft·s. Compute the hydraulic diameter, and express the head loss in terms of  $Q$ :

$$D_h = \frac{4A}{P} = \frac{4(1/2)(9)(9 \sin 60^\circ)}{3(9)} = 5.2'' = 0.433 \text{ ft}$$

$$h_f = f \frac{L}{D_h} \frac{(Q/A)^2}{2g} = f \left( \frac{90}{0.433} \right) \frac{\{Q/[0.5(9/12)^2 \sin 60^\circ]\}^2}{2(32.2)} \approx 54.4fQ^2$$

For sheet steel, take  $\varepsilon \approx 0.00015$  ft, hence  $\varepsilon/D_h \approx 0.000346$ . Now relate everything to the input power:

$$\text{Power} = 1 \text{ hp} = 550 \frac{\text{ft}\cdot\text{lbf}}{\text{s}} = \rho g Q h_f = (0.00234)(32.2)Q[54.4fQ^2],$$

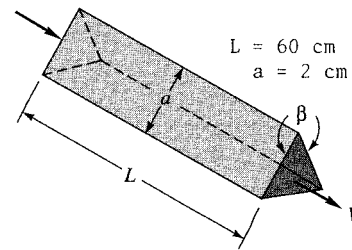
$$\text{or: } fQ^3 \approx 134 \quad \text{with } Q \text{ in ft}^3/\text{s}$$

$$\text{Guess } f \approx 0.02, \quad Q = (134/0.02)^{1/3} \approx 18.9 \frac{\text{ft}^3}{\text{s}}, \quad \text{Re} = \frac{\rho(Q/A)D_h}{\mu} \approx 209000$$

Iterate:  $f_{\text{better}} \approx 0.0179$ ,  $Q_{\text{better}} \approx 19.6 \text{ ft}^3/\text{s}$ ,  $\text{Re}_{\text{better}} \approx 216500$ . The process converges to

$$f \approx 0.01784, \quad V \approx 80.4 \text{ ft/s}, \quad Q \approx \mathbf{19.6 \text{ ft}^3/\text{s}}. \quad \text{Ans.}$$

**6.91** Heat exchangers often consist of many triangular passages. Typical is Fig. P6.91, with  $L = 60$  cm and an isosceles-triangle cross section of side length  $a = 2$  cm and included angle  $\beta = 80^\circ$ . If the average velocity is  $V = 2$  m/s and the fluid is SAE 10 oil at  $20^\circ\text{C}$ , estimate the pressure drop.



**Fig. P6.91**

**Solution:** For SAE 10 oil, take  $\rho = 870 \text{ kg/m}^3$  and  $\mu = 0.104 \text{ kg/m}\cdot\text{s}$ . The Reynolds number based on side length  $a$  is  $\text{Re} = \rho Va/\mu \approx \mathbf{335}$ , so the flow is *laminar*. The bottom side of the triangle is  $2(2 \text{ cm})\sin 40^\circ \approx 2.57 \text{ cm}$ . Calculate hydraulic diameter:

$$A = \frac{1}{2}(2.57)(2 \cos 40^\circ) \approx 1.97 \text{ cm}^2; \quad P = 6.57 \text{ cm}; \quad D_h = \frac{4A}{P} \approx 1.20 \text{ cm}$$

$$\text{Re}_{D_h} = \frac{\rho V D_h}{\mu} = \frac{870(2.0)(0.0120)}{0.104} \approx 201; \quad \text{from Table 6.4, } \theta = 40^\circ, \quad f\text{Re} \approx 52.9$$

$$\text{Then } f = \frac{52.9}{201} \approx 0.263, \quad \Delta p = f \frac{L}{D_h} \frac{\rho}{2} V^2 = (0.263) \left( \frac{0.6}{0.012} \right) \left( \frac{870}{2} \right) (2)^2$$

$$\approx \mathbf{23000 \text{ Pa}} \quad \text{Ans.}$$

**6.92** A large room uses a fan to draw in atmospheric air at 20°C through a 30 cm by 30 cm commercial-steel duct 12 m long, as in Fig. P6.92. Estimate (a) the air flow rate in m<sup>3</sup>/hr if the room pressure is 10 Pa vacuum; and (b) the room pressure if the flow rate is 1200 m<sup>3</sup>/hr. Neglect minor losses.

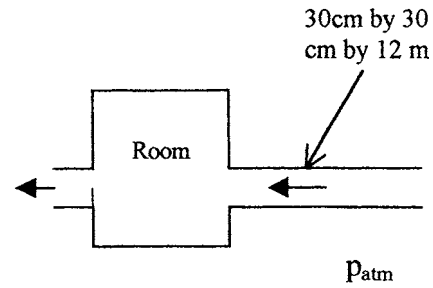


Fig. P6.92

**Solution:** For air, take  $\rho = 1.2 \text{ kg/m}^3$  and  $\mu = 1.8\text{E-}5 \text{ kg/m}\cdot\text{s}$ . For commercial steel,  $\varepsilon = 0.046 \text{ mm}$ . For a square duct,  $D_h = \text{side-length} = 30 \text{ cm}$ , hence  $\varepsilon/d = 0.046/300 = 0.000153$ . The (b) part is easier, with flow rate known we can evaluate velocity, Reynolds number, and friction factor:

$$V = \frac{Q}{A} = \frac{1200/3600}{(0.3)(0.3)} = 3.70 \frac{\text{m}}{\text{s}}, \quad Re_{D_h} = \frac{1.2(3.70)(0.3)}{1.8\text{E-}5} = 74100, \quad \text{thus } f_{\text{Moody}} \approx 0.0198$$

Then the pressure drop follows immediately:

$$\Delta p = f \frac{L}{D_h} \frac{\rho}{2} V^2 = 0.0198 \left( \frac{12}{0.3} \right) \left( \frac{1.2}{2} \right) (3.70)^2 = 6.53 \text{ Pa},$$

$$\text{or: } \mathbf{p_{\text{room}} = 6.5 \text{ Pa (vacuum) Ans. (b)}}$$

(a) If  $\Delta p = 10 \text{ Pa (vacuum)}$  is known, we must iterate to find friction factor:

$$\Delta p = 10 \text{ Pa} = f \left( \frac{12}{0.3} \right) \left( \frac{1.2}{2} \right) V^2, \quad V = \frac{Q}{(0.3)^2}, \quad f = f_{\text{cn}} \left( \frac{1.2V(0.3)}{1.8\text{E-}5}, \frac{\varepsilon}{D_h} = 0.000153 \right)$$

After iteration, the results converge to:

$$V = 4.69 \text{ m/s}; \quad Re_d = 93800; \quad f = 0.0190; \quad \mathbf{Q = 0.422 \text{ m}^3/\text{s} = 1520 \text{ m}^3/\text{h} \text{ Ans. (a)}}$$

**6.93** Modify Prob. 6.91 so that the angle  $\beta$  is unknown. For SAE 10 oil at 20°C, if the pressure drop is 120 kPa and the flow rate is 4 m<sup>3</sup>/h, what is the proper value of the angle  $\beta$ , in degrees?

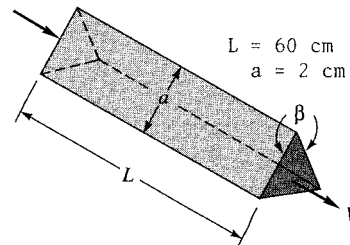


Fig. P6.91

**Solution:** For SAE 10 oil, take  $\rho = 870 \text{ kg/m}^3$  and  $\mu = 0.104 \text{ kg/m}\cdot\text{s}$ . This problem can be done by hand but would benefit from a computer program. Note that, for arbitrary  $\beta$ ,

$$A = \frac{1}{2}(a \sin \theta)(2a \cos \theta) = \frac{a^2}{2} \sin \beta; \quad P = 2a(1 + \sin \theta); \quad D_h = \frac{4A}{P} = \frac{a \sin \beta}{1 + \sin \theta}, \quad \theta = \frac{\beta}{2}$$

Let “C” =  $f\text{Re}$  as tabulated for various  $\beta$  in Table 6.4. Then, with  $V = Q/A$ ,

$$\Delta p = f \frac{L}{D_h} \frac{\rho}{2} V^2 = \frac{C\mu}{\rho V D_h} \frac{L}{D_h} \frac{\rho V^2}{2} = \frac{C\mu L Q}{2D_h^2 A}$$

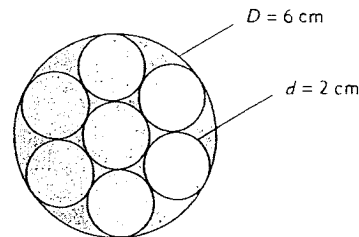
Introduce  $D_h$  and  $A$  in terms of  $a$  and  $\beta$  above to obtain: 
$$\frac{\sin^3 \beta}{[1 + \sin(\beta/2)]^2} = \frac{\mu L C Q}{a^4 \Delta p}$$

where  $C \approx 50 \pm 6\%$  as taken from Table 6.4. For our particular data, we have

$$\frac{\sin^3 \beta}{[1 + \sin(\beta/2)]^2} = \frac{(0.104)(0.6)(4/3600)C}{(0.02)^4 (120000)} = 0.0036C \approx 0.18 \pm 6\%$$

By trial and error,  $\beta \approx 45^\circ$  *Ans.*

**6.94** As shown in Fig. P6.94, a multiduct cross section consists of seven 2-cm-diameter smooth thin tubes packed tightly in a hexagonal “bundle” within a single 6-cm-diameter tube. Air, at about  $20^\circ\text{C}$  and 1 atm, flows through this system at  $150 \text{ m}^3/\text{h}$ . Estimate the pressure drop per meter.



**Fig. P6.94**

**Solution:** For air, take  $\rho = 1.2 \text{ kg/m}^3$  and  $\mu = 1.8\text{E}-5 \text{ kg/m}\cdot\text{s}$ . A separate analysis would show that the small triangular cusped passages have *fifty times more resistance* to the flow than the 2-cm-diameter tubes. Therefore we assume all the flow goes through the seven 2-cm tubes. Thus each tube takes one-seventh of the flow rate:

$$V = \frac{Q}{A_{7 \text{ tubes}}} = \frac{150/3600}{7\pi(0.01)^2} \approx 18.95 \frac{\text{m}}{\text{s}}, \quad \text{Re} = \frac{\rho V d}{\mu} = \frac{1.2(18.95)(0.02)}{1.8\text{E}-5} \approx 25300$$

$$\text{Turbulent: } f_{\text{smooth}} \approx 0.0245, \quad \Delta p = f \frac{L}{d} \frac{\rho}{2} V^2 = 0.0245 \left( \frac{1.0}{0.02} \right) \frac{1.2}{2} (18.95)^2$$

$\Delta p \approx 260 \text{ Pa}$  *Ans.*



**6.95** A wind tunnel is made of wood and is 28 m long, with a rectangular section 50 cm by 80 cm. It draws in sea-level standard air with a fan. If the fan delivers 7 kW of power to the air, estimate (a) the average velocity; and (b) the pressure drop in the wind tunnel.

**Solution:** For sea-level air,  $\rho = 1.22 \text{ kg/m}^3$  and  $\mu = 1.81\text{E-}5 \text{ kg/m}\cdot\text{s}$ . The hydraulic diameter is:

$$D_h = \frac{4A}{P} = \frac{4(50 \text{ cm})(80 \text{ cm})}{2(50 + 80 \text{ cm})} = 61.54 \text{ cm} = 0.6154 \text{ m}$$

(a, b) The known power is related to both the flow rate and the pressure drop:

$$\begin{aligned} \text{Power} &= Q\Delta p = [HWV] \left[ f \frac{L}{D_h} \frac{\rho}{2} V^2 \right] \\ &= [(0.5 \text{ m})(0.8 \text{ m})V] \left[ f \frac{28 \text{ m}}{0.6154 \text{ m}} \frac{1.22 \text{ kg/m}^3}{2} V^2 \right] = 11.1fV^3 = 7000 \text{ W} \end{aligned}$$

Thus we need to find  $V$  such that  $fV^3 = 631 \text{ m}^3/\text{s}^3$ . For wood, take roughness  $\varepsilon = 0.5 \text{ mm}$ . Then  $\varepsilon/D_h = 0.0005 \text{ m}/0.6154 \text{ m} = 0.000813$ . Use the Moody chart to find  $V$  and the Reynolds number. Guess  $f \approx 0.02$  to start, or use EES. The iteration converges to:

$$f = 0.0189, \quad \text{Re}_{D_h} = 1.33\text{E}6, \quad V = 32 \text{ m/s}, \quad \Delta p = 540 \text{ Pa} \quad \text{Ans. (a, b)}$$

**6.96** Water at 20°C is flowing through a 20-cm-square smooth duct at a (turbulent) Reynolds number of 100,000. For a “laminar flow element” measurement, it is desired to pack the pipe with a honeycomb array of small square passages (see Fig. P6.28 for an example). What passage width  $h$  will ensure that the flow in each tube will be laminar (Reynolds number less than 2000)?

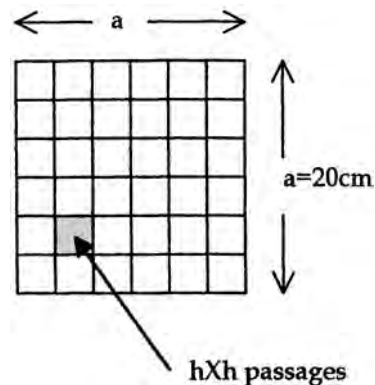


Fig. P6.96

**Solution:** The hydraulic diameter of a square is the side length  $h$  (or  $a$ ). For water, take  $\rho = 998 \text{ kg/m}^3$  and  $\mu = 0.001 \text{ kg/m}\cdot\text{s}$ . The Reynolds number establishes flow velocity:

$$\text{Re}_{D_h} = 100,000 = \frac{\rho V d}{\mu} = \frac{998V(0.2)}{0.001}, \quad \text{Solve for } V = 0.501 \frac{\text{m}}{\text{s}}$$

This velocity is the same when we introduce small passages, if we neglect the blockage of the thin passage walls. Thus we merely set the passage Reynolds number = 2000:

$$Re_h \frac{\rho V h}{\mu} = \frac{998(0.501)h}{0.001} \leq 2000 \quad \text{if } h \leq \mathbf{0.004 \text{ m} = 4 \text{ mm}} \quad \text{Ans.}$$

**6.97** A heat exchanger consists of multiple parallel-plate passages, as shown in Fig. P6.97. The available pressure drop is 2 kPa, and the fluid is water at 20°C. If the desired total flow rate is 900 m<sup>3</sup>/h, estimate the appropriate number of passages. The plate walls are hydraulically smooth.

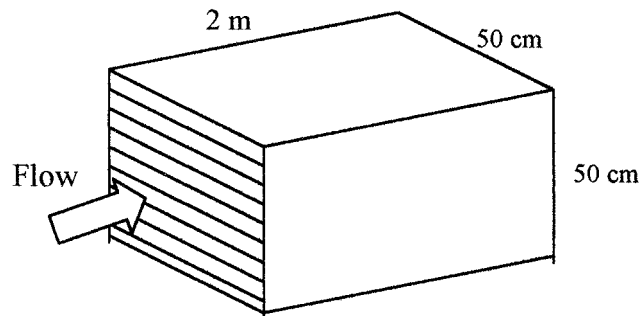


Fig. P6.97

**Solution:** For water,  $\rho = 998 \text{ kg/m}^3$  and  $\mu = 0.001 \text{ kg/m}\cdot\text{s}$ . Unlike Prob. 6.88, here we expect turbulent flow. If there are  $N$  passages, then  $b = 50 \text{ cm}$  for all  $N$  and the passage thickness is  $H = 0.5 \text{ m}/N$ . The hydraulic diameter is  $D_h = 2H$ . The velocity in each passage is related to the pressure drop by Eq. (6.58):

$$\Delta p = f \frac{L}{D_h} \frac{\rho}{2} V^2 \quad \text{where } f = f_{\text{smooth}} = f_{\text{cn}} \left( \frac{\rho V D_h}{\mu} \right)$$

$$\text{For the given data, } 2000 \text{ Pa} = f \frac{2.0 \text{ m}}{2(0.5 \text{ m}/N)} \frac{998 \text{ kg/m}^3}{2} V^2$$

Select  $N$ , find  $H$  and  $V$  and  $Q_{\text{total}} = AV = b^2 V$  and compare to the desired flow of 900 m<sup>3</sup>/h. For example, guess  $N = 20$ , calculate  $f = 0.0173$  and  $Q_{\text{total}} = 2165 \text{ m}^3/\text{h}$ . The converged result is

$$Q_{\text{total}} = 908 \text{ m}^3/\text{h}, \quad f = 0.028,$$

$$Re_{D_h} = 14400, \quad H = 7.14 \text{ mm}, \quad N = \mathbf{70 \text{ passages}} \quad \text{Ans.}$$

**6.98** A rectangular heat exchanger is to be divided into smaller sections using sheets of commercial steel 0.4 mm thick, as sketched in Fig. P6.98. The flow rate is 20 kg/s of water at 20°C. Basic dimensions are  $L = 1$  m,  $W = 20$  cm, and  $H = 10$  cm. What is the proper number of *square* sections if the overall pressure drop is to be no more than 1600 Pa?

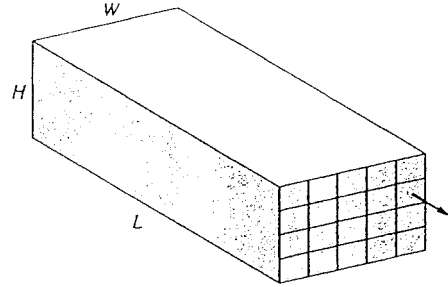


Fig. P6.98

**Solution:** For water at 20°C, take  $\rho = 998$  kg/m<sup>3</sup> and  $\mu = 0.001$  kg/m·s. For commercial steel,  $\varepsilon \approx 0.046$  mm. Let the short side (10 cm) be divided into “J” squares. Then the long (20 cm) side divides into “2J” squares and altogether there are  $N = 2J^2$  squares. Denote the side length of the square as “a,” which equals (10 cm)/J minus the wall thickness. The hydraulic diameter of a square exactly equals its side length,  $D_h = a$ . Then the pressure drop relation becomes

$$\Delta p = f \frac{L}{D_h} \frac{\rho}{2} V^2 = f \frac{1.0}{a} \left( \frac{998}{2} \right) \left( \frac{Q}{Na^2} \right)^2 \leq 1600 \text{ Pa, where } N = 2J^2 \text{ and } a = \frac{0.1}{J} - 0.0004$$

As a first estimate, neglect the 0.4-mm wall thickness, so  $a \approx 0.1/J$ . Then the relation for  $\Delta p$  above reduces to  $fJ \approx 0.32$ . Since  $f \approx 0.036$  for this turbulent Reynolds number ( $Re \approx 1E4$ ) we estimate that  $J \approx 9$  and in fact this is not bad even including wall thickness:

$$J = 9, \quad N = 2(9)^2 = 162, \quad a = \frac{0.1}{9} - 0.0004 = 0.0107 \text{ m}, \quad V = \frac{20/998}{162(0.0107)^2} \approx 1.078 \frac{\text{m}}{\text{s}}$$

$$Re = \frac{\rho Va}{\mu} = \frac{998(1.078)(0.0107)}{0.001} \approx 11526, \quad \frac{\varepsilon}{a} = \frac{0.046}{10.7} \approx 0.00429, \quad f_{\text{Moody}} \approx 0.0360$$

$$\text{Then } \Delta p = (0.036) \left( \frac{1.0}{0.0107} \right) \left( \frac{998}{2} \right) (1.078)^2 \approx 1950 \text{ Pa}$$

So the wall thickness increases  $V$  and decreases  $a$  so  $\Delta p$  is too large. Try  $J = 8$ :

$$J = 8, \quad N = 128, \quad a = 0.0121 \text{ m}, \quad V = 1.069 \frac{\text{m}}{\text{s}},$$

$$Re = 12913, \quad \frac{\varepsilon}{a} = 0.0038, \quad f \approx 0.0347$$

$$\text{Then } \Delta p = f(L/a)(\rho/2)V^2 \approx \mathbf{1636 \text{ Pa.}} \quad \text{Close enough, } J = 8, \mathbf{N = 128} \quad \text{Ans.}$$

[I suppose a practical person would specify  $J = 7$ ,  $N = 98$ , to keep  $\Delta p < 1600$  Pa.]

**6.99** Air, approximately at sea-level standard conditions, is to be delivered at  $3 \text{ m}^3/\text{s}$  through a horizontal square commercial-steel duct. What are the appropriate duct dimensions if the pressure drop is not to exceed  $90 \text{ Pa}$  over a  $100\text{-m}$  length?

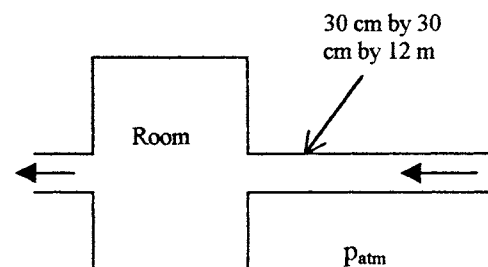
**Solution:** For air at  $15^\circ\text{C}$ , take  $\rho = 1.225 \text{ kg/m}^3$  and  $\mu = 1.78\text{E-}5 \text{ kg/m}\cdot\text{s}$ . Denote the side length of the square duct by  $a$ , note that  $D_h = a$  itself. For commercial steel,  $\varepsilon = 0.046 \text{ mm}$ , hence  $\varepsilon/d = 4.6\text{E-}5/a$ , with  $a$  in meters. The pressure drop specification is

$$\Delta p = f \frac{L}{D_h} \frac{\rho}{2} V^2 = f \left( \frac{100}{a} \right) \left( \frac{1.225}{2} \right) \left( \frac{3.0}{a^2} \right)^2 = \frac{551f}{a^5} < 90 \text{ Pa}, \quad \text{or: } a^5 > 6.125f$$

We find  $f_{\text{Moody}}$  based on  $\text{Re}_{D_h} = \rho Va/\mu = \rho Q/a\mu = 206500/a$  and  $\varepsilon/d = 4.6\text{E-}5/a$ . Iteration is required, and the results converge to

$$\text{Re}_{D_h} = 333,000; \quad f = 0.0150; \quad a \geq \mathbf{0.62 \text{ m}} \quad \text{Ans.}$$

**6.100** Repeat Prob. 6.92 by including minor losses due to a sharp-edged entrance, the exit into the room, and an open gate valve. If the room pressure is  $10 \text{ Pa}$  (vacuum), by what percentage is the flow rate decreased from part (a) of Prob. 6.92?



**Fig. P6.100**

**Solution:** For air, take  $\rho = 1.2 \text{ kg/m}^3$  and  $\mu = 1.8\text{E-}5 \text{ kg/m}\cdot\text{s}$ . For commercial steel,  $\varepsilon = 0.046 \text{ mm}$ . For a square duct,  $D_h = \text{side-length} = 30 \text{ cm}$ , hence  $\varepsilon/d = 0.046/300 = 0.000153$ . Now add  $K_{\text{entrance}} = 0.5$ ,  $K_{\text{exit}} = 1.0$ , and  $K_{\text{valve}} = 0.03$  to the energy equation:

$$\Delta p = 10 \text{ Pa} = \frac{\rho}{2} V^2 \left( f \frac{L}{D_h} + \sum K_{\text{minor}} \right) = \left( \frac{1.2}{2} \right) \left[ \frac{Q}{(0.3)^2} \right]^2 \left( f \frac{12}{0.3} + 0.5 + 1.0 + 0.03 \right)$$

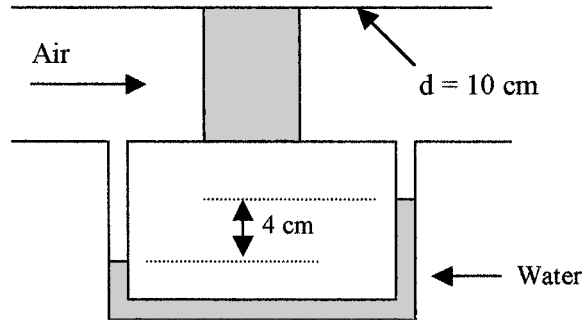
where we compute  $f$  based on  $\text{Re}_{D_h} = (1.2)V(0.3)/1.8\text{E-}5$  and  $\varepsilon/D_h = 0.000153$ . The iteration converges to

$$V = 2.65 \text{ m/s}; \quad \text{Re}_d = 53000; \quad f = 0.0212; \quad Q = 0.238 \text{ m}^3/\text{s} = \mathbf{860 \text{ m}^3/\text{h}}$$

*Moral:* Don't forget minor losses! The flow rate is **43%** less than Prob. 6.92! *Ans.*

**NOTE: IN PROBLEMS 6.100–6.110, MINOR LOSSES ARE INCLUDED.**

**6.101** In Fig. P6.101 a thick filter is being tested for losses. The flow rate in the pipe is  $7 \text{ m}^3/\text{min}$ , and the upstream pressure is  $120 \text{ kPa}$ . The fluid is air at  $20^\circ\text{C}$ . Using the water-manometer reading, estimate the loss coefficient  $K$  of the filter.



**Fig. P6.101**

**Solution:** The upstream density is  $\rho_{\text{air}} = p/(RT) = 120000/[287(293)] = 1.43 \text{ kg/m}^3$ . The average velocity  $V$  (which is used to correlate loss coefficient) follows from the flow rate:

$$V = \frac{Q}{A_{\text{pipe}}} = \frac{7/60 \text{ m}^3/\text{s}}{(\pi/4)(0.1 \text{ m})^2} = 14.85 \text{ m/s}$$

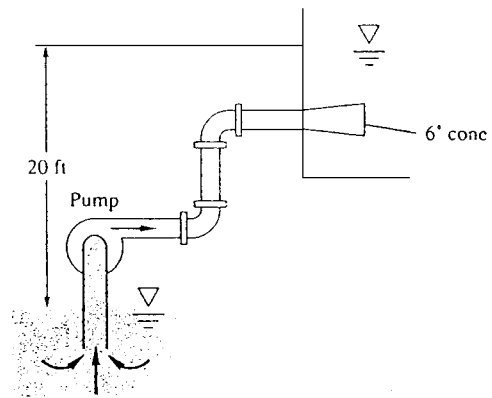
The manometer measures the pressure drop across the filter:

$$\Delta p_{\text{mano}} = (\rho_w - \rho_a)gh_{\text{mano}} = (998 - 1.43 \text{ kg/m}^3)(9.81 \text{ m/s}^2)(0.04 \text{ m}) = 391 \text{ Pa}$$

This pressure is correlated as a loss coefficient using Eq. (6.78):

$$K_{\text{filter}} = \frac{\Delta p_{\text{filter}}}{(1/2)\rho V^2} = \frac{391 \text{ Pa}}{(1/2)(1.43 \text{ kg/m}^3)(14.85 \text{ m/s})^2} \approx 2.5 \text{ Ans.}$$

**6.102** A 70 percent efficient pump delivers water at  $20^\circ\text{C}$  from one reservoir to another 20 ft higher, as in Fig. P6.102. The piping system consists of 60 ft of galvanized-iron 2-in pipe, a reentrant entrance, two screwed  $90^\circ$  long-radius elbows, a screwed-open gate valve, and a sharp exit. What is the input power required in horsepower with and without a  $6^\circ$  well-designed conical expansion added to the exit? The flow rate is  $0.4 \text{ ft}^3/\text{s}$ .



**Fig. P6.102**

**Solution:** For water at 20°C, take  $\rho = 1.94 \text{ slug/ft}^3$  and  $\mu = 2.09\text{E-}5 \text{ slug/ft}\cdot\text{s}$ . For galvanized iron,  $\varepsilon \approx 0.0005 \text{ ft}$ , whence  $\varepsilon/d = 0.0005/(2/12 \text{ ft}) \approx 0.003$ . Without the 6° cone, the minor losses are:

$$K_{\text{reentrant}} \approx 1.0; \quad K_{\text{elbows}} \approx 2(0.41); \quad K_{\text{gate valve}} \approx 0.16; \quad K_{\text{sharp exit}} \approx 1.0$$

$$\text{Evaluate } V = \frac{Q}{A} = \frac{0.4}{\pi(2/12)^2/4} = 18.3 \frac{\text{ft}}{\text{s}}; \quad \text{Re} = \frac{\rho V d}{\mu} = \frac{1.94(18.3)(2/12)}{2.09\text{E-}5} \approx 284000$$

At this Re and roughness ratio, we find from the Moody chart that  $f \approx 0.0266$ . Then

$$(a) \quad h_{\text{pump}} = \Delta z + \frac{V^2}{2g} \left( f \frac{L}{d} + \sum K \right) = 20 + \frac{(18.3)^2}{2(32.2)} \left[ 0.0266 \left( \frac{60}{2/12} \right) + 1.0 + 0.82 + 0.16 + 1.0 \right]$$

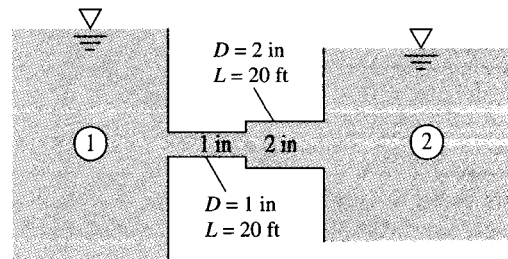
$$\text{or } h_{\text{pump}} \approx 85.6 \text{ ft}, \quad \text{Power} = \frac{\rho g Q h_p}{\eta} = \frac{(62.4)(0.4)(85.6)}{0.70} \\ = 3052 \div 550 \approx \mathbf{5.55 \text{ hp}} \quad \text{Ans. (a)}$$

(b) If we replace the sharp exit by a 6° conical diffuser, from Fig. 6.23,  $K_{\text{exit}} \approx 0.3$ . Then

$$h_p = 20 + \frac{(18.3)^2}{2(32.2)} \left[ 0.0266 \left( \frac{60}{2/12} \right) + 1.0 + .82 + .16 + 0.3 \right] = 81.95 \text{ ft}$$

$$\text{then } \text{Power} = (62.4)(0.4)(81.95)/0.7 \div 550 \approx \mathbf{5.31 \text{ hp}} \text{ (4\% less)} \quad \text{Ans. (b)}$$

**6.103** The reservoirs in Fig. P6.103 are connected by cast-iron pipes joined abruptly, with sharp-edged entrance and exit. Including minor losses, estimate the flow of water at 20°C if the surface of reservoir 1 is 45 ft higher than that of reservoir 2.



**Fig. P6.103**

**Solution:** For water at 20°C, take  $\rho = 1.94 \text{ slug/ft}^3$  and  $\mu = 2.09\text{E-}5 \text{ slug/ft}\cdot\text{s}$ . Let “a” be the small pipe and “b” the larger. For wrought iron,  $\varepsilon \approx 0.00015 \text{ ft}$ , whence  $\varepsilon/d_a = 0.0018$  and  $\varepsilon/d_b = 0.0009$ . From the continuity relation,

$$Q = V_a \frac{\pi}{4} d_a^2 = V_b \frac{\pi}{4} d_b^2 \quad \text{or, since } d_b = 2d_a, \quad \text{we obtain } V_b = \frac{1}{4} V_a$$

For pipe “a” there are two minor losses: a sharp entrance,  $K_1 = 0.5$ , and a sudden expansion, Fig. 6.22, Eq. (6.101),  $K_2 = [1 - (1/2)^2]^2 \approx 0.56$ . For pipe “b” there is one minor loss, the submerged exit,  $K_3 \approx 1.0$ . The energy equation, with equal pressures at (1) and (2) and near zero velocities at (1) and (2), yields

$$\Delta z = h_{f-a} + \sum h_{m-a} + h_{f-b} + \sum h_{m-b} = \frac{V_a^2}{2g} \left( f_a \frac{L_a}{d_a} + 0.5 + 0.56 \right) + \frac{V_b^2}{2g} \left( f_b \frac{L_b}{d_b} + 1.0 \right),$$

$$\text{or, since } V_b = V_a/4, \quad \Delta z = 45 \text{ ft} = \frac{V_a^2}{2(32.2)} \left[ 240f_a + 1.06 + \frac{120}{16} f_b + \frac{1.0}{16} \right]$$

where  $f_a$  and  $f_b$  are separately related to different values of  $Re$  and  $\varepsilon/d$ . Guess to start:

$$f_a \approx f_b \approx 0.02: \quad \text{then } V_a = 21.85 \text{ ft/s}, \quad Re_a \approx 169000, \quad \varepsilon/d_a = 0.0018, \quad f_{a-2} \approx 0.0239$$

$$V_b = 5.46 \text{ ft/s}, \quad Re_b \approx 84500, \quad \varepsilon/d_b = 0.0009, \quad f_{b-2} \approx 0.0222$$

$$\text{Converges to: } f_a = 0.024, \quad f_b = 0.0224, \quad V_a \approx 20.3 \text{ ft/s},$$

$$Q = V_a A_a \approx \mathbf{0.111 \text{ ft}^3/\text{s}}. \quad \text{Ans.}$$

**6.104** Reconsider the air hockey table of Problem 3.162, but with inclusion of minor losses. The table is 3 ft by 6 ft in area, with 1/16-in-diameter holes spaced every inch in a rectangular grid (2592 holes total). The required jet speed from each hole is 50 ft/s. Your job is to select an appropriate blower to meet the requirements.

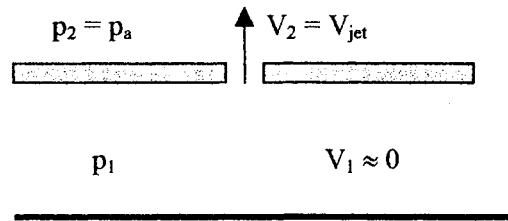


Fig. P3.162

*Hint:* Assume that the air is stagnant in the manifold under the table surface, and assume sharp-edge inlets at each hole. (a) Estimate the pressure rise (in lbf/in<sup>2</sup>) required of the blower. (b) Compare your answer to the previous calculation in Prob. 3.162, where minor losses were ignored. Are minor losses significant?

**Solution:** Write the energy equation between manifold and atmosphere:

$$\frac{p_1}{\rho g} + \alpha_1 \frac{V_1^2}{2g} + z_1 = \frac{p_2}{\rho g} + \alpha_2 \frac{V_2^2}{2g} + z_2 + h_{losses}, \quad \text{where } h_{losses} \approx K_{inlet} \frac{V_{jet}^2}{2g}$$

Neglect  $V_1 \approx 0$  and  $z_1 \approx z_2$ , assume  $\alpha_{1,2} = 1.0$ , and solve for

$$\Delta p = p_1 - p_2 = \frac{\rho}{2} V_{jet}^2 (1 + K_{inlet}), \quad \text{where } K_{sharp-edge-inlet} \approx 0.5$$

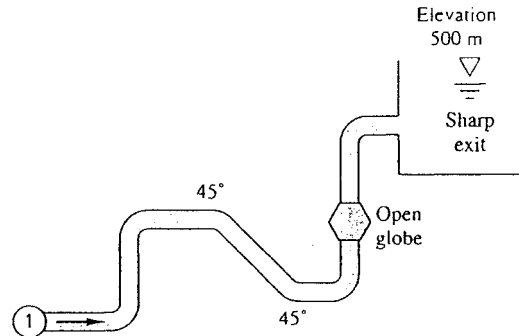
Clearly, the pressure drop is about **50% greater** due to the minor loss. *Ans. (b)*

Work out  $\Delta p$ , assuming  $\rho_{\text{air}} \approx 0.00234 \text{ slug/ft}^3$ :

$$\Delta p = \frac{0.00234}{2}(50)^2(1+0.5) = 4.39 \frac{\text{lb}_f}{\text{ft}^2} \div 144 = \mathbf{0.0305 \frac{\text{lb}_f}{\text{in}^2}} \quad \text{Ans. (a)}$$

(Again, this is 50% higher than Prob. 3.162.)

**6.105** The system in Fig. P6.105 consists of 1200 m of 5 cm cast-iron pipe, two 45° and four 90° flanged long-radius elbows, a fully open flanged globe valve, and a sharp exit into a reservoir. If the elevation at point 1 is 400 m, what gage pressure is required at point 1 to deliver 0.005 m<sup>3</sup>/s of water at 20°C into the reservoir?



**Fig. P6.105**

**Solution:** For water at 20°C, take  $\rho = 998 \text{ kg/m}^3$  and  $\mu = 0.001 \text{ kg/m}\cdot\text{s}$ . For cast iron, take  $\epsilon \approx 0.26 \text{ mm}$ , hence  $\epsilon/d = 0.0052$ . With the flow rate known, we can compute  $V$ ,  $Re$ :

$$V = \frac{Q}{A} = \frac{0.005}{(\pi/4)(0.05)^2} = 2.55 \frac{\text{m}}{\text{s}}; \quad Re = \frac{998(2.55)(0.05)}{0.001} \approx 127000, \quad f_{\text{Moody}} \approx 0.0315$$

The minor losses may be listed as follows:

45° long-radius elbow:  $K \approx 0.2$ ; 90° long-radius elbow:  $K \approx 0.3$

Open flanged globe valve:  $K \approx 8.5$ ; submerged exit:  $K \approx 1.0$

Then the energy equation between (1) and (2—the reservoir surface) yields

$$\frac{p_1}{\rho g} + \frac{V_1^2}{2g} + z_1 = 0 + 0 + z_2 + h_f + \sum h_m,$$

$$\text{or: } p_1/(\rho g) = 500 - 400 + \frac{(2.55)^2}{2(9.81)} \left[ 0.0315 \left( \frac{1200}{0.05} \right) + 0.5 + 2(0.2) + 4(0.3) + 8.5 + 1 - 1 \right]$$

$$= 100 + 253 = 353 \text{ m, or: } p_1 = (998)(9.81)(353) \approx \mathbf{3.46 \text{ MPa}} \quad \text{Ans.}$$



**6.106** The water pipe in Fig. 6.106 slopes upward at  $30^\circ$ . The pipe is 1-inch diameter and *smooth*. The flanged globe valve is fully open. If the mercury manometer shows a 7-inch deflection, what is the flow rate in cubic feet per sec?

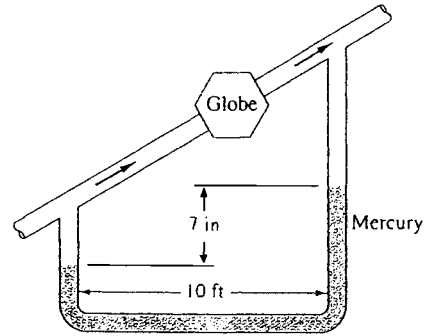


Fig. P6.106

**Solution:** For water at  $20^\circ\text{C}$ , take  $\rho = 1.94 \text{ slug/ft}^3$  and  $\mu = 2.09\text{E-}5 \text{ slug/ft}\cdot\text{s}$ . The pipe length and elevation change are

$$L = \frac{10 \text{ ft}}{\cos 30^\circ} = 11.55 \text{ ft}; \quad z_2 - z_1 = 10 \tan 30^\circ = 5.77 \text{ ft}, \quad \text{Open 1'' globe valve: } K \approx 13$$

The manometer indicates the total pressure change between (1) and (2):

$$p_1 - p_2 = (\rho_{\text{Merc}} - \rho_w)gh + \rho_w g \Delta z = (13.6 - 1)(62.4) \left( \frac{7}{12} \right) + 62.4(5.77) \approx 819 \text{ psf}$$

The energy equation yields

$$\frac{p_1 - p_2}{\rho g} = \Delta z + h_f + h_m = 5.77 + \frac{V^2}{2(32.2)} \left[ f \frac{11.55}{1/12} + 13 \right] \approx \frac{819 \text{ lbf/ft}^2}{62.4 \text{ lbf/ft}^3}$$

or:  $V^2 \approx \frac{2(32.2)(7.35)}{(139f + 13)}$ . Guess  $f \approx 0.02$ ,  $V \approx 5.48 \frac{\text{ft}}{\text{s}}$ ,  $\text{Re} \approx 42400$ ,  $f_{\text{new}} \approx 0.0217$

Rapid convergence to  $f \approx 0.0217$ ,  $V \approx 5.44 \text{ ft/s}$ ,  $Q = V(\pi/4)(1/12)^2 \approx \mathbf{0.0296 \text{ ft}^3/\text{s}}$ . *Ans.*  
[NOTE that the manometer reading of 7 inches exactly balances the friction losses, and the hydrostatic pressure change  $\rho g \Delta z$  cancels out of the energy equation.]

**6.107** In Fig. P6.107 the pipe is galvanized iron. Estimate the percentage increase in the flow rate (a) if the pipe entrance is cut off flush with the wall and (b) if the butterfly valve is opened wide.

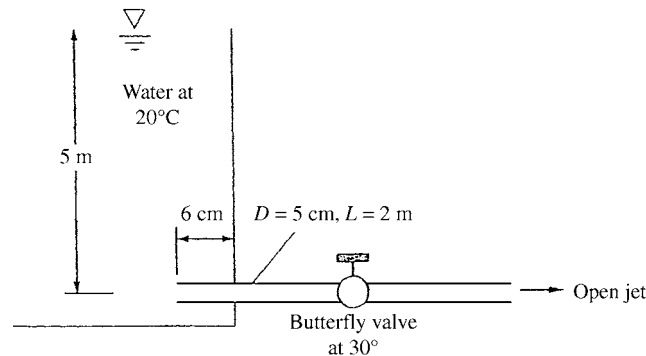


Fig. P6.107

**Solution:** For water at 20°C, take  $\rho = 998 \text{ kg/m}^3$  and  $\mu = 0.001 \text{ kg/m}\cdot\text{s}$ . For galvanized iron, take  $\varepsilon \approx 0.15 \text{ mm}$ , hence  $\varepsilon/d = 0.003$ . First establish minor losses as shown:

$$\text{Protruding entrance (Fig. 6.21a), } \frac{L}{d} \approx 1.2, K \approx 1;$$

$$\text{Butterfly @ } 30^\circ \text{ (Fig 6.19) } K \approx 80 \pm 20$$

The energy equation, with  $p_1 = p_2$ , yields:

$$\Delta z = \frac{V^2}{2g} + h_f + \sum h_m = \frac{V^2}{2g} \left[ 1 + f \frac{L}{d} + \sum K \right] = \frac{V^2}{2(9.81)} \left[ 1 + f \left( \frac{2}{0.05} \right) + 1.0 + 80 \pm 20 \right] = 5 \text{ m}$$

$$\text{Guess } f \approx 0.02, \quad V \approx 1.09 \frac{\text{m}}{\text{s}}, \quad \text{Re} \approx 54300, \quad \frac{\varepsilon}{d} = 0.003,$$

$$f_{\text{new}} \approx 0.0284, \quad V_{\text{new}} \approx 1.086 \frac{\text{m}}{\text{s}}$$

Thus the “base” flow, for our comparison, is  $V_o \approx 1.086 \text{ m/s}$ ,  $Q_o \approx 0.00213 \text{ m}^3/\text{s}$ .

If we cut off the entrance flush, we reduce  $K_{\text{ent}}$  from 1.0 to **0.5**; hardly a significant reduction in view of the huge butterfly valve loss  $K_{\text{valve}} \approx 80$ . The energy equation is

$$5 \text{ m} = \frac{V^2}{2(9.81)} [1 + 40f + 0.5 + 80 \pm 20], \quad \text{solve } V \approx 1.090 \frac{\text{m}}{\text{s}},$$

$$Q = \mathbf{0.00214} \frac{\text{m}^3}{\text{s}} \text{ (0.3\% more) } \text{ Ans. (a)}$$

If we open the butterfly wide,  $K_{\text{valve}}$  decreases from 80 to only **0.3**, a *huge* reduction:

$$5 \text{ m} = \frac{V^2}{2(9.81)} [1 + 40f + 1.0 + 0.3], \quad \text{solve } V \approx 5.4 \frac{\text{m}}{\text{s}},$$

$$Q = \mathbf{0.0106} \frac{\text{m}^3}{\text{s}} \text{ (5 times more) } \text{ Ans. (b)}$$

Obviously opening the valve has a dominant effect for this system.

**6.108** The water pump in Fig. P6.108 maintains a pressure of 6.5 psig at point 1. There is a filter, a half-open disk valve, and two regular screwed elbows. There are 80 ft of 4-inch diameter commercial steel pipe. (a) If the flow rate is  $0.4 \text{ ft}^3/\text{s}$ , what is the loss coefficient of the filter? (b) If the disk valve is wide open and  $K_{\text{filter}} = 7$ , what is the resulting flow rate?

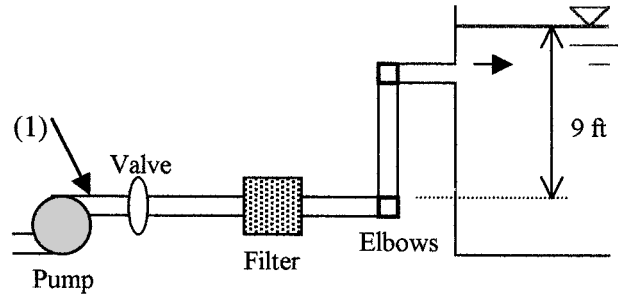


Fig. P6.108

**Solution:** For water, take  $\rho = 1.94 \text{ slug/ft}^3$  and  $\mu = 2.09\text{E-}5 \text{ slug/ft}\cdot\text{s}$ . The energy equation is written from point 1 to the surface of the tank:

$$\frac{p_1}{\rho g} + \frac{V_1^2}{2g} + z_1 = \frac{p_2}{\rho g} + \frac{V_2^2}{2g} + z_2 + h_f + K_{valve} + K_{filter} + 2K_{elbow} + K_{exit}$$

(a) From the flow rate,  $V_1 = Q/A = (0.4 \text{ ft}^3/\text{s})/[(\pi/4)(4/12 \text{ ft})^2] = 4.58 \text{ ft/s}$ . Look up minor losses and enter into the energy equation:

$$\begin{aligned} & \frac{(6.5)(144) \text{ lbf/ft}^2}{62.4 \text{ lbf/ft}^3} + \frac{(4.58 \text{ ft/s})^2}{2(32.2 \text{ ft/s}^2)} + 0 \\ & = 0 + 0 + 9 \text{ ft} + \frac{(4.58)^2}{2(32.2)} \left[ f \frac{80 \text{ ft}}{(4/12 \text{ ft})} + 2.8 + K_{filter} + 2(0.64) + 1 \right] \end{aligned}$$

We can solve for  $K_{filter}$  if we evaluate  $f$ . Compute  $Re_D = (1.94)(4.58)(4/12)/(2.09\text{E-}5) = 141,700$ . For commercial steel,  $\varepsilon/D = 0.00015 \text{ ft}/0.333 \text{ ft} = 0.00045$ . From the Moody chart,  $f \approx 0.0193$ , and  $fL/D = 4.62$ . The energy equation above becomes:

$$15.0 \text{ ft} + 0.326 \text{ ft} = 9 \text{ ft} + 0.326(4.62 + 2.8 + K_{filter} + 1.28 + 1) \text{ ft},$$

$$\text{Solve } K_{filter} \approx 9.7 \text{ Ans. (a)}$$

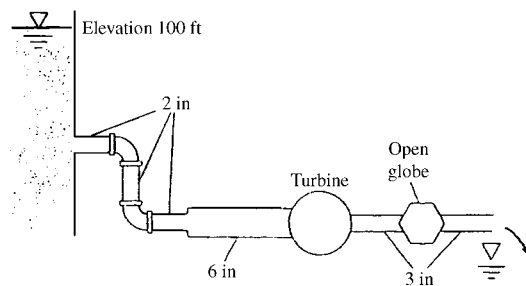
(b) If  $K_{filter} = 7.0$  and  $V$  is unknown, we must iterate for the velocity and flow rate. The energy equation becomes, with the disk valve wide open ( $K_{valve} \approx 0$ ):

$$15.0 \text{ ft} + \frac{V^2}{2(32.2)} = 9 \text{ ft} + \frac{V^2}{2(32.2)} \left( f \frac{80}{1/3} + 0 + 7.0 + 1.28 + 1 \right)$$

$$\text{Iterate to find } f \approx 0.0189, \quad Re_D = 169,000, \quad V = 5.49 \text{ ft/s},$$

$$\mathbf{Q = AV = 0.48 \text{ ft}^3/\text{s} \text{ Ans. (b)}}$$

**6.109** In Fig. P6.109 there are 125 ft of 2-in pipe, 75 ft of 6-in pipe, and 150 ft of 3-in pipe, all cast iron. There are three 90° elbows and an open globe valve, all flanged. If the exit elevation is zero, what horsepower is extracted by the turbine when the flow rate is 0.16 ft<sup>3</sup>/s of water at 20°C?



**Fig. P6.109**

**Solution:** For water at 20°C, take  $\rho = 1.94$  slug/ft<sup>3</sup> and  $\mu = 2.09\text{E-}5$  slug/ft·s. For cast iron,  $\varepsilon \approx 0.00085$  ft. The 2", 6", and 3" pipes have, respectively,

- (a)  $L/d = 750$ ,  $\varepsilon/d = 0.0051$ ; (b)  $L/d = 150$ ,  $\varepsilon/d = 0.0017$ ;  
 (c)  $L/d = 600$ ,  $\varepsilon/d = 0.0034$

The flow rate is known, so each velocity, Reynolds number, and  $f$  can be calculated:

$$V_a = \frac{0.16}{\pi(2/12)^2/4} = 7.33 \frac{\text{ft}}{\text{s}}; \quad \text{Re}_a = \frac{1.94(7.33)(2/12)}{2.09\text{E-}5} = 113500, \quad f_a \approx 0.0314$$

$$\text{Also, } V_b = 0.82 \text{ ft/s, } \text{Re}_b = 37800, \quad f_c \approx 0.0266; \quad V_c = 3.26, \quad \text{Re}_c = 75600, \quad f_c \approx 0.0287$$

Finally, the minor loss coefficients may be tabulated:

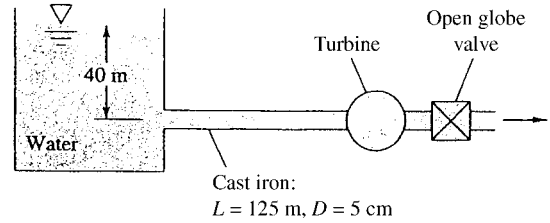
$$\begin{aligned} \text{sharp 2" entrance: } K &= 0.5; & \text{three 2" 90° elbows: } K &= 3(0.95) \\ \text{2" sudden expansion: } K &\approx 0.79; & \text{3" open globe valve: } K &\approx 6.3 \end{aligned}$$

The turbine head equals the elevation difference minus losses and the exit velocity head:

$$\begin{aligned} h_t &= \Delta z - \sum h_f - \sum h_m - V_c^2/(2g) \\ &= 100 - \frac{(7.33)^2}{2(32.2)} [0.0314(750) + 0.5 + 3(0.95) + 0.79] \\ &\quad - \frac{(0.82)^2}{2(32.2)} (0.0266)(150) - \frac{(3.26)^2}{2(32.2)} [0.0287(600) + 6.3 + 1] \approx \mathbf{72.8 \text{ ft}} \end{aligned}$$

The resulting turbine power =  $\rho g Q h_t = (62.4)(0.16)(72.8) \div 550 \approx \mathbf{1.32 \text{ hp}}$ . *Ans.*

**6.110** In Fig. P6.110 the pipe entrance is sharp-edged. If the flow rate is  $0.004 \text{ m}^3/\text{s}$ , what power, in W, is extracted by the turbine?



**Fig. P6.110**

**Solution:** For water at  $20^\circ\text{C}$ , take  $\rho = 998 \text{ kg/m}^3$  and  $\mu = 0.001 \text{ kg/m}\cdot\text{s}$ . For cast iron,  $\varepsilon \approx 0.26 \text{ mm}$ , hence  $\varepsilon/d = 0.26/50 \approx 0.0052$ . The minor loss coefficients are Entrance:  $K \approx 0.5$ ; 5-cm ( $\approx 2''$ ) open globe valve:  $K \approx 6.9$

The flow rate is known, hence we can compute  $V$ ,  $Re$ , and  $f$ :

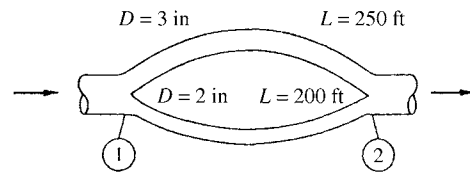
$$V = \frac{Q}{A} = \frac{0.004}{(\pi/4)(0.05)^2} = 2.04 \frac{\text{m}}{\text{s}}, \quad Re = \frac{998(2.04)(0.05)}{0.001} \approx 102000, \quad f \approx 0.0316$$

The turbine head equals the elevation difference minus losses and exit velocity head:

$$h_t = \Delta z - h_f - \sum h_m - \frac{V^2}{2g} = 40 - \frac{(2.04)^2}{2(9.81)} \left[ (0.0316) \left( \frac{125}{0.05} \right) + 0.5 + 6.9 + 1 \right] \approx 21.5 \text{ m}$$

$$\text{Power} = \rho g Q h_t = (998)(9.81)(0.004)(21.5) \approx \mathbf{840 \text{ W}} \quad \text{Ans.}$$

**6.111** For the parallel-pipe system of Fig. P6.111, each pipe is cast iron, and the pressure drop  $p_1 - p_2 = 3 \text{ lbf/in}^2$ . Compute the total flow rate between 1 and 2 if the fluid is SAE 10 oil at  $20^\circ\text{C}$ .



**Fig. P6.111**

**Solution:** For SAE 10 oil at  $20^\circ\text{C}$ , take  $\rho = 1.69 \text{ slug/ft}^3$  and  $\mu = 0.00217 \text{ slug/ft}\cdot\text{s}$ . For cast iron,  $\varepsilon \approx 0.00085 \text{ ft}$ . Convert  $\Delta p = 3 \text{ psi} = 432 \text{ psf}$  and guess laminar flow in each:

$$\Delta p_a = \frac{? 128\mu L_a Q_a}{\pi d_a^4} = 432 = \frac{128(0.00217)(250)Q_a}{\pi(3/12)^4},$$

$$Q_a \approx 0.0763 \frac{\text{ft}^3}{\text{s}}. \quad \text{Check } Re \approx 300 \text{ (OK)}$$

$$\Delta p_b = \frac{? 128\mu L_b Q_b}{\pi d_b^4} = 432 = \frac{128(0.00217)(200)Q_b}{\pi(2/12)^4},$$

$$Q_b \approx 0.0188 \frac{\text{ft}^3}{\text{s}}. \quad \text{Check } Re \approx 112 \text{ (OK)}$$

$$\text{The total flow rate is } \mathbf{Q = Q_a + Q_b = 0.0763 + 0.0188 \approx 0.095 \text{ ft}^3/\text{s}. \quad \text{Ans.}}$$

**6.112** If the two pipes in Fig. P6.111 are instead laid in **series** with the same total pressure drop of 3 psi, what will the flow rate be? The fluid is SAE 10 oil at 20°C.

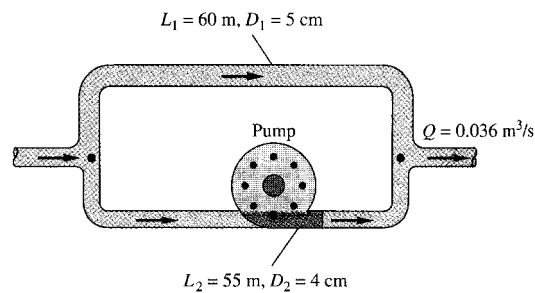
**Solution:** For SAE 10 oil at 20°C, take  $\rho = 1.69$  slug/ft<sup>3</sup> and  $\mu = 0.00217$  slug/ft·s. Again guess laminar flow. Now, instead of  $\Delta p$  being the same,  $Q_a = Q_b = Q$ :

$$\Delta p_a + \Delta p_b = 432 \text{ psf} = \frac{128\mu L_a Q}{\pi d_a^4} + \frac{128\mu L_b Q}{\pi d_b^4} = \frac{128(0.00217)}{\pi} Q \left[ \frac{250}{(3/12)^4} + \frac{200}{(2/12)^4} \right]$$

Solve for  $Q \approx \mathbf{0.0151 \text{ ft}^3/\text{s}}$  Ans. Check  $Re_a \approx 60$  (OK) and  $Re_b \approx 90$  (OK)

In series, the flow rate is six times less than when the pipes are in parallel.

**6.113** The parallel galvanized-iron pipe system of Fig. P6.113 delivers water at 20°C with a total flow rate of 0.036 m<sup>3</sup>/s. If the pump is wide open and not running, with a loss coefficient  $K = 1.5$ , determine (a) the flow rate in each pipe and (b) the overall pressure drop.



**Fig. P6.113**

**Solution:** For water at 20°C, take  $\rho = 998$  kg/m<sup>3</sup> and  $\mu = 0.001$  kg/m·s. For galvanized iron,  $\varepsilon = 0.15$  mm. Assume turbulent flow, with  $\Delta p$  the same for each leg:

$$h_{f1} = f_1 \frac{L_1}{d_1} \frac{V_1^2}{2g} = h_{f2} + h_{m2} = \frac{V_2^2}{2g} \left( f_2 \frac{L_2}{d_2} + 1.5 \right),$$

$$\text{and } Q_1 + Q_2 = (\pi/4)d_1^2 V_1 + (\pi/4)d_2^2 V_2 = Q_{\text{total}} = 0.036 \text{ m}^3/\text{s}$$

When the friction factors are correctly found from the Moody chart, these two equations may be solved for the two velocities (or flow rates). Begin by guessing  $f \approx 0.020$ :

$$(0.02) \left( \frac{60}{0.05} \right) \frac{V_1^2}{2(9.81)} = \frac{V_2^2}{2(9.81)} \left[ (0.02) \left( \frac{55}{0.04} \right) + 1.5 \right], \text{ solve for } V_1 \approx 1.10V_2$$

$$\text{then } \frac{\pi}{4}(0.05)^2(1.10V_2) + \frac{\pi}{4}(0.04)^2 V_2 = 0.036. \text{ Solve } V_2 \approx 10.54 \frac{\text{m}}{\text{s}}, V_1 \approx 11.59 \frac{\text{m}}{\text{s}}$$

Correct  $Re_1 \approx 578000$ ,  $f_1 \approx 0.0264$ ,  $Re_2 \approx 421000$ ,  $f_2 \approx 0.0282$ , repeat.

The 2nd iteration converges:  $f_1 \approx 0.0264$ ,  $V_1 = 11.69$  m/s,  $f_2 \approx 0.0282$ ,  $V_2 = 10.37$  m/s,

$$Q_1 = A_1 V_1 = \mathbf{0.023 \text{ m}^3/\text{s}}, \quad Q_2 = A_2 V_2 = \mathbf{0.013 \text{ m}^3/\text{s}}. \text{ Ans. (a)}$$

The pressure drop is the same in either leg:

$$\Delta p = f_1 \frac{L_1 \rho V_1^2}{d_1} = \left( f_2 \frac{L_2}{d_2} + 1.5 \right) \frac{\rho V_2^2}{2} \approx \mathbf{2.16E6 \text{ Pa}} \quad \text{Ans. (b)}$$

**6.114** Modify Prob. 6.113 as follows: Let the pump be running and delivering 45 kW to the flow in pipe 2. The fluid is gasoline at 20°C. Determine (a) the flow rate in each pipe, and (b) the overall pressure drop.

**Solution:** For gasoline at 20°C, take  $\rho = 680 \text{ kg/m}^3$  and  $\mu = 2.92\text{E-}4 \text{ kg/m}\cdot\text{s}$ . For galvanized iron, take  $\varepsilon = 0.15 \text{ mm}$ , hence  $\varepsilon/d_1 = 0.0030$  and  $\varepsilon/d_2 = 0.00375$ . The volume-flow relation is the same as in Prob. 6.113, but the head loss in pipe 2 is reduced by the pump head delivered:

$$h_{f1} = f_1 \frac{L_1}{d_1} \frac{V_1^2}{2g} = h_{f2} - h_{\text{pump}} = f_2 \frac{L_2}{d_2} \frac{V_2^2}{2g} - \frac{45000 \text{ W}}{\rho g Q_2}$$

$$Q_1 + Q_2 = (\pi/4)d_1^2 V_1 + (\pi/4)d_2^2 V_2 = Q_{\text{total}} = 0.036 \text{ m}^3/\text{s}$$

If we introduce the given data, we obtain two simultaneous algebraic equations:

$$f_1 \frac{60}{0.05} \frac{V_1^2}{2(9.81)} = f_2 \frac{55}{0.04} \frac{V_2^2}{2(9.81)} - \frac{45000}{680(9.81)(\pi/4)(0.04)^2 V_2},$$

or:  $61.16 f_1 V_1^2 = 70.08 f_2 V_2^2 - 5368/V_2$  with V in m/s

plus  $(\pi/4)(0.05)^2 V_1 + (\pi/4)(0.04)^2 V_2 = 0.036 \text{ m}^3/\text{s}$

The right hand side of the 1st equation should not be negative, hence  $V_2 > 15 \text{ m/s}$ . One solution scheme is to guess  $V_2 \geq 15$  and then calculate  $V_1$  from each equation. We also guess  $f_1 \approx 0.026$  and  $f_2 \approx 0.028$  from the solution to Prob. 6.113—but remember, the fluid is *gasoline* now:

If  $V_2 \approx 15 \frac{\text{m}}{\text{s}}$ , head loss gives  $V_1 \approx 7.19 \frac{\text{m}}{\text{s}}$ , volume flow gives  $V_1 \approx 8.73 \frac{\text{m}}{\text{s}}$

If  $V_2 \approx 16 \frac{\text{m}}{\text{s}}$ , head loss gives  $V_1 \approx 10.18 \frac{\text{m}}{\text{s}}$ , volume flow gives  $V_1 \approx 8.09 \frac{\text{m}}{\text{s}}$

Clearly the correct  $V_2$  is somewhere *between* 15 and 16 m/s. The iteration converges to:

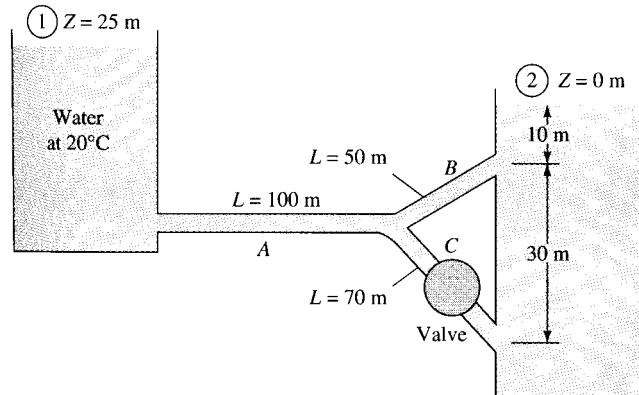
$$V_2 = 15.39 \text{ m/s}, \quad \text{Re}_2 = 1.43\text{E}6, \quad f_2 \approx 0.0280, \quad Q_2 = A_2 V_2 = \mathbf{0.0193 \text{ m}^3/\text{s}} \quad \text{Ans. (a)}$$

$$V_1 = 8.48 \text{ m/s}, \quad \text{Re}_1 = 9.94\text{E}5, \quad f_1 \approx 0.0263, \quad Q_1 = A_1 V_1 = \mathbf{0.0167 \text{ m}^3/\text{s}} \quad \text{Ans. (a)}$$

The pressure drop is the same in either leg:

$$\Delta p = f_1 \frac{L_1}{d_1} \frac{\rho V_1^2}{2} = f_2 \frac{L_2}{d_2} \frac{\rho V_2^2}{2} = \frac{45000}{Q_2} \approx \mathbf{774,000 \text{ Pa}} \quad \text{Ans. (b)}$$

**6.115** In Fig. P6.115 all pipes are 8-cm-diameter cast iron. Determine the flow rate from reservoir (1) if valve C is (a) closed; and (b) open, with  $K_{\text{valve}} = 0.5$ .



**Fig. P6.115**

**Solution:** For water at 20°C, take  $\rho = 998 \text{ kg/m}^3$  and  $\mu = 0.001 \text{ kg/m}\cdot\text{s}$ . For cast iron,  $\varepsilon \approx 0.26 \text{ mm}$ , hence  $\varepsilon/d = 0.26/80 \approx 0.00325$  for all three pipes. Note  $p_1 = p_2$ ,  $V_1 = V_2 \approx 0$ . These are long pipes, but we might wish to account for minor losses anyway:

sharp entrance at A:  $K_1 \approx 0.5$ ; line junction from A to B:  $K_2 \approx 0.9$  (Table 6.5)

branch junction from A to C:  $K_3 \approx 1.3$ ; two submerged exits:  $K_B = K_C \approx 1.0$

If valve C is closed, we have a straight *series* path through A and B, with the same flow rate  $Q$ , velocity  $V$ , and friction factor  $f$  in each. The energy equation yields

$$z_1 - z_2 = h_{fA} + \sum h_{mA} + h_{fB} + \sum h_{mB},$$

$$\text{or: } 25 \text{ m} = \frac{V^2}{2(9.81)} \left[ f \frac{100}{0.08} + 0.5 + 0.9 + f \frac{50}{0.08} + 1.0 \right], \quad \text{where } f = \text{fcn} \left( \text{Re}, \frac{\varepsilon}{d} \right)$$

Guess  $f \approx f_{\text{fully rough}} \approx 0.027$ , then  $V \approx 3.04 \text{ m/s}$ ,  $\text{Re} \approx 998(3.04)(0.08)/(0.001) \approx 243000$ ,  $\varepsilon/d = 0.00325$ , then  $f \approx 0.0273$  (converged). Then the velocity through A and B is  $V = 3.03 \text{ m/s}$ , and  $Q = (\pi/4)(0.08)^2(3.03) \approx \mathbf{0.0152 \text{ m}^3/\text{s}}$ . *Ans. (a).*



If valve C is open, we have parallel flow through B and C, with  $Q_A = Q_B + Q_C$  and, with  $d$  constant,  $V_A = V_B + V_C$ . The total head loss is the same for paths A-B and A-C:

$$z_1 - z_2 = h_{fA} + \sum h_{m_{A-B}} + h_{fB} + \sum h_{m_B} = h_{fA} + \sum h_{m_{A-C}} + h_{fC} + \sum h_{m_C},$$

$$\begin{aligned} \text{or: } 25 &= \frac{V_A^2}{2(9.81)} \left[ f_A \frac{100}{0.08} + 0.5 + 0.9 \right] + \frac{V_B^2}{2(9.81)} \left[ f_B \frac{50}{0.08} + 1.0 \right] \\ &= \frac{V_A^2}{2(9.81)} \left[ f_A \frac{100}{0.08} + 0.5 + 1.3 \right] + \frac{V_C^2}{2(9.81)} \left[ f_C \frac{70}{0.08} + 1.0 \right] \end{aligned}$$

plus the additional relation  $V_A = V_B + V_C$ . Guess  $f \approx f_{\text{fully rough}} \approx 0.027$  for all three pipes and begin. The initial numbers work out to

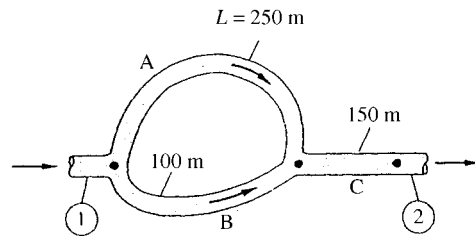
$$2g(25) = 490.5 = V_A^2(1250f_A + 1.4) + V_B^2(625f_B + 1) = V_A^2(1250f_A + 1.8) + V_C^2(875f_C + 1)$$

If  $f \approx 0.027$ , solve (laboriously)  $V_A \approx 3.48$  m/s,  $V_B \approx 1.91$  m/s,  $V_C \approx 1.57$  m/s.

$$\begin{aligned} \text{Compute } Re_A &= 278000, \quad f_A \approx 0.0272, \quad Re_B = 153000, \quad f_B = 0.0276, \\ Re_C &= 125000, \quad f_C = 0.0278 \end{aligned}$$

Repeat once for convergence:  $V_A \approx 3.46$  m/s,  $V_B \approx 1.90$  m/s,  $V_C \approx 1.56$  m/s. The flow rate from reservoir (1) is  $Q_A = (\pi/4)(0.08)^2(3.46) \approx \mathbf{0.0174 \text{ m}^3/\text{s}}$ . (14% more) *Ans. (b)*

**6.116** For the series-parallel system of Fig. P6.116, all pipes are 8-cm-diameter asphalted cast iron. If the total pressure drop  $p_1 - p_2 = 750$  kPa, find the resulting flow rate  $Q$  m<sup>3</sup>/h for water at 20°C. Neglect minor losses.



**Fig. P6.116**

**Solution:** For water at 20°C, take  $\rho = 998$  kg/m<sup>3</sup> and  $\mu = 0.001$  kg/m·s. For asphalted cast iron,  $\epsilon \approx 0.12$  mm, hence  $\epsilon/d = 0.12/80 \approx 0.0015$  for all three pipes. The head loss is the same through AC and BC:

$$\frac{\Delta p}{\rho g} = h_{fA} + h_{fC} = h_{fB} + h_{fC} = \left( f \frac{L}{d} \frac{V^2}{2g} \right)_A + \left( f \frac{L}{d} \frac{V^2}{2g} \right)_C = \left( f \frac{L}{d} \frac{V^2}{2g} \right)_B + \left( f \frac{L}{d} \frac{V^2}{2g} \right)_C$$

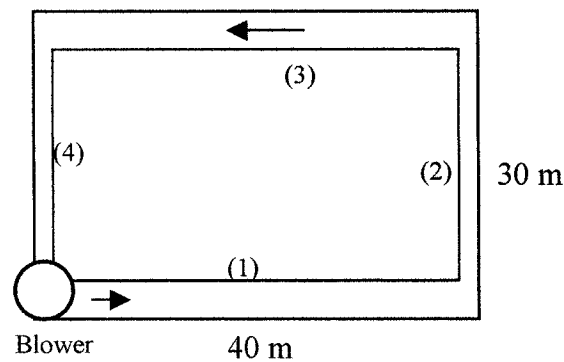
Since  $d$  is the same,  $V_A + V_B = V_C$  and  $f_A, f_B, f_C$  are found from the Moody chart. Cancel  $g$  and introduce the given data:

$$\frac{750000}{998} = f_A \frac{250}{0.08} \frac{V_A^2}{2} + f_C \frac{150}{0.08} \frac{V_C^2}{2} = f_B \frac{100}{0.08} \frac{V_B^2}{2} + f_C \frac{150}{0.08} \frac{V_C^2}{2}, \quad V_A + V_B = V_C$$

Guess  $f_{\text{rough}} \approx 0.022$  and solve laboriously:  $V_A \approx 2.09 \frac{\text{m}}{\text{s}}, V_B \approx 3.31 \frac{\text{m}}{\text{s}}, V_C \approx 5.40 \frac{\text{m}}{\text{s}}$

Now compute  $Re_A \approx 167000, f_A \approx 0.0230, Re_B \approx 264000, f_B \approx 0.0226, Re_C \approx 431000,$  and  $f_C \approx 0.0222$ . Repeat the head loss iteration and we converge:  $V_A \approx 2.06 \text{ m/s}, V_B \approx 3.29 \text{ m/s}, V_C \approx 5.35 \text{ m/s}, Q = (\pi/4)(0.08)^2(5.35) \approx \mathbf{0.0269 \text{ m}^3/\text{s}}$ . *Ans.*

**6.117** A blower delivers air at  $3000 \text{ m}^3/\text{h}$  to the duct circuit in Fig. P6.117. Each duct is commercial steel and of square cross-section, with side lengths  $a_1 = a_3 = 20 \text{ cm}$  and  $a_2 = a_4 = 12 \text{ cm}$ . Assuming sea-level air conditions, estimate the power required if the blower has an efficiency of 75%. Neglect minor losses.



**Fig. P6.117**

**Solution:** For air take  $\rho = 1.2 \text{ kg/m}^3$  and  $\mu = 1.8E-5 \text{ kg/m}\cdot\text{s}$ . Establish conditions in each duct:

$$Q = \frac{3000}{3600} = 0.833 \frac{\text{m}^3}{\text{s}}; \quad V_{1\&3} = \frac{0.833 \text{ m}^3/\text{s}}{(0.2 \text{ m})^2} = 20.8 \text{ m/s}; \quad Re_{1\&3} = \frac{1.2(20.8)(0.2)}{1.8E-5} = 278,000$$

$$V_{2\&4} = \frac{0.833 \text{ m}^3/\text{s}}{(0.12 \text{ m})^2} = 57.8 \text{ m/s}; \quad Re_{2\&4} = \frac{1.2(57.8)(0.12)}{1.8E-5} = 463,000$$

For commercial steel (Table 6.1)  $\varepsilon = 0.046 \text{ mm}$ . Then we can find the two friction factors:

$$\frac{\varepsilon}{D}|_{1\&3} = \frac{0.046}{200} = 0.00023; \quad Re_{1\&3} = 278000; \quad \text{Moody chart: } f_{1\&3} \approx 0.0166$$

$$\frac{\varepsilon}{D}|_{2\&4} = \frac{0.046}{120} = 0.000383; \quad Re_{2\&4} = 463000; \quad \text{Moody chart: } f_{1\&3} \approx 0.0170$$

$$\text{Then } \Delta p_{1\&3} = \left( f \frac{L}{D} \frac{\rho V^2}{2} \right)_{1\&3} = (0.0166) \left( \frac{80}{0.2} \right) \frac{(1.2)(20.8)^2}{2} = 1730 \text{ Pa}$$

$$\text{and } \Delta p_{2\&4} = \left( f \frac{L}{D} \frac{\rho V^2}{2} \right)_{1\&3} = (0.0170) \left( \frac{60}{0.12} \right) \frac{(1.2)(57.8)^2}{2} = 17050 \text{ Pa}$$

The total power required, at 75% efficiency, is thus:

$$Power = \frac{Q\Delta p}{\eta} = \frac{(0.833 \text{ m}^3/\text{s})(1730 + 17050 \text{ Pa})}{0.75} = \mathbf{20900 \text{ W}} \quad \text{Ans.}$$

**6.118** For the piping system of Fig. P6.118, all pipes are concrete with a roughness of 0.04 inch. Neglecting minor losses, compute the overall pressure drop  $p_1 - p_2$  in  $\text{lbf/in}^2$ . The flow rate is  $20 \text{ ft}^3/\text{s}$  of water at  $20^\circ\text{C}$ .

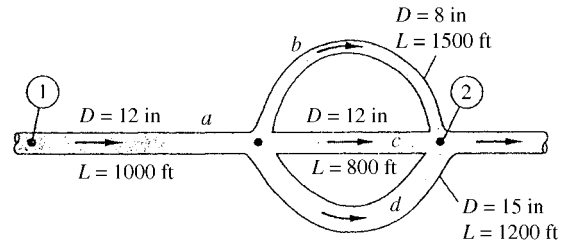


Fig. P6.118

**Solution:** For water at  $20^\circ\text{C}$ , take  $\rho = 1.94 \text{ slug/ft}^3$  and  $\mu = 2.09\text{E-}5 \text{ slug/ft}\cdot\text{s}$ . Since the pipes are all different make a little table of their respective  $L/d$  and  $\epsilon/d$ :

(a)	$L = 1000 \text{ ft}$ ,	$d = 12 \text{ in}$ ,	$L/d = 1000$ ,	$\epsilon/d = \mathbf{0.00333}$
(b)	$1500 \text{ ft}$	$8 \text{ in}$	$2250$	$\mathbf{0.00500}$
(c)	$800 \text{ ft}$	$12 \text{ in}$	$800$	$\mathbf{0.00333}$
(d)	$1200 \text{ ft}$	$15 \text{ in}$	$960$	$\mathbf{0.00267}$

With the flow rate known, we can find everything in pipe (a):

$$V_a = \frac{Q_a}{A_a} = \frac{20}{(\pi/4)(1 \text{ ft})^2} = 25.5 \frac{\text{ft}}{\text{s}}, \quad Re_a = \frac{1.94(25.5)(1)}{2.09\text{E-}5} = 2.36\text{E}6, \quad f_a \approx 0.0270$$

Then pipes (b,c,d) are in parallel, each having the same head loss and with flow rates which must add up to the total of  $20 \text{ ft}^3/\text{s}$ :

$$h_{fb} = \frac{8f_b L_b Q_b^2}{\pi^2 g d_b^5} = h_{fc} = \frac{8f_c L_c Q_c^2}{\pi^2 g d_c^5} = h_{fd} = \frac{8f_d L_d Q_d^2}{\pi^2 g d_d^5}, \quad \text{and} \quad Q_b + Q_c + Q_d = 20 \frac{\text{ft}^3}{\text{s}}$$

Introduce  $L_b, d_b$ , etc. to find that  $Q_c = 3.77Q_b(f_b/f_c)^{1/2}$  and  $Q_d = 5.38Q_b(f_b/f_d)^{1/2}$

Then the flow rates are iterated from the relation

$$\Sigma Q = 20 \frac{\text{ft}^3}{\text{s}} = Q_b [1 + 3.77(f_b/f_c)^{1/2} + 5.38(f_b/f_d)^{1/2}]$$

First guess:  $f_b = f_c = f_d$ :  $Q_b \approx 1.97 \text{ ft}^3/\text{s}$ ;  $Q_c \approx 7.43 \text{ ft}^3/\text{s}$ ;  $Q_d \approx 10.6 \text{ ft}^3/\text{s}$

Improve by computing  $Re_b \approx 349000$ ,  $f_b \approx 0.0306$ ,  $Re_c \approx 878000$ ,  $f_c \approx 0.0271$ ,  $Re_d \approx 1002000$ ,  $f_d \approx 0.0255$ . Repeat to find  $Q_b \approx 1.835 \text{ ft}^3/\text{s}$ ,  $Q_c \approx 7.351 \text{ ft}^3/\text{s}$ ,  $Q_d \approx 10.814 \text{ ft}^3/\text{s}$ . Repeat once more and quit:  $Q_b \approx 1.833 \text{ ft}^3/\text{s}$ ,  $Q_c \approx 7.349 \text{ ft}^3/\text{s}$ ,  $Q_d \approx 10.819 \text{ ft}^3/\text{s}$ , from which  $V_b \approx 5.25 \text{ ft/s}$ ,  $V_c \approx 9.36 \text{ ft/s}$ ,  $V_d \approx 8.82 \text{ ft/s}$ . The pressure drop is

$$\begin{aligned} p_1 - p_2 = \Delta p_a + \Delta p_b &= f_a \frac{L_a}{d_a} \frac{\rho V_a^2}{2} + f_b \frac{L_b}{d_b} \frac{\rho V_b^2}{2} \\ &= 17000 + 1800 \approx 18800 \text{ psf} \approx \mathbf{131 \frac{\text{lbf}}{\text{in}^2}} \quad \text{Ans.} \end{aligned}$$

**6.119** Modify Prob. 6.118 as follows. Let the pressure drop ( $p_1 - p_2$ ) be  $98 \text{ lbf/in}^2$ . Neglecting minor losses, determine the flow rate in  $\text{ft}^3/\text{s}$ .

**Solution:** From the solution just above for  $\Delta p \approx 131 \text{ psi}$ , we can see that  $\Delta p_a$  is about 90.2% of the total drop. Therefore our first guess can be that

$$\Delta p_a \approx 0.902 \Delta p = 0.902(98 \times 144) \approx 12729 \text{ psf} = f_a \frac{L_a}{d_a} \frac{\rho V_a^2}{2} \approx (0.027)(1000) \frac{1.94 V_a^2}{2}$$

$$\text{Solve for } V_a \approx 22.05 \frac{\text{ft}}{\text{s}}$$

$$\text{and } Q_a = A_a V_a \approx 17.3 \frac{\text{ft}^3}{\text{s}} = Q_b [1 + 3.77(f_b/f_c)^{1/2} + 5.38(f_b/f_d)^{1/2}]$$

The last relation is still valid just as it was in Prob. 6.188. We can iterate to find

$$f_a \approx 0.0270, \quad Q_b \approx 1.585 \frac{\text{ft}^3}{\text{s}}, \quad Q_c \approx 6.357 \frac{\text{ft}^3}{\text{s}}, \quad Q_d \approx 9.358 \frac{\text{ft}^3}{\text{s}}, \quad f_b \approx 0.0307$$

$$p_1 - p_2 = f_a (L_a/d_a) (\rho V_a^2/2) + f_b (L_b/d_b) (\rho V_b^2/2) \approx 12717 + 1382 = 14099 \text{ psf} \approx 97.9 \text{ psi}$$

This is certainly close enough. We conclude the flow rate is  $Q \approx \mathbf{17.3 \text{ ft}^3/\text{s}}$ . *Ans.*

**6.120** Three cast-iron pipes are laid in parallel with these dimensions:

$$\text{Pipe 1: } \quad L_1 = 800 \text{ m} \quad d_1 = 12 \text{ cm}$$

$$\text{Pipe 2: } \quad L_2 = 600 \text{ m} \quad d_2 = 8 \text{ cm}$$

$$\text{Pipe 3: } \quad L_3 = 900 \text{ m} \quad d_3 = 10 \text{ cm}$$

The total flow rate is  $200 \text{ m}^3/\text{h}$  of water at  $20^\circ\text{C}$ . Determine (a) the flow rate in each pipe; and (b) the pressure drop across the system.

**Solution:** For water at 20°C, take  $\rho = 998 \text{ kg/m}^3$  and  $\mu = 0.001 \text{ kg/m}\cdot\text{s}$ . For cast iron,  $\varepsilon = 0.26 \text{ mm}$ . Then,  $\varepsilon/d_1 = 0.00217$ ,  $\varepsilon/d_2 = 0.00325$ , and  $\varepsilon/d_3 = 0.0026$ . The head losses are the same for each pipe, and the flow rates add:

$$h_f = \frac{8f_1L_1Q_1^2}{\pi^2gd_1^5} = \frac{8f_2L_2Q_2^2}{\pi^2gd_2^5} = \frac{8f_3L_3Q_3^2}{\pi^2gd_3^5}; \quad \text{and} \quad Q_1 + Q_2 + Q_3 = \frac{200 \text{ m}^3}{3600 \text{ s}}$$

$$\text{Substitute and combine: } Q_1[1 + 0.418(f_1/f_2)^{1/2} + 0.599(f_1/f_3)^{1/2}] = 0.0556 \text{ m}^3/\text{s}$$

We could either go directly to EES or begin by guessing  $f_1 = f_2 = f_3$ , which gives  $Q_1 = 0.0275 \text{ m}^3/\text{s}$ ,  $Q_2 = 0.0115 \text{ m}^3/\text{s}$ , and  $Q_3 = 0.0165 \text{ m}^3/\text{s}$ . This is *very* close! Further iteration gives

$$\text{Re}_1 = 298000, \quad f_1 = 0.0245; \quad \text{Re}_2 = 177000, \quad f_2 = 0.0275; \quad \text{Re}_3 = 208000, \quad f_3 = 0.0259$$

$$Q_1 = \mathbf{0.0281 \text{ m}^3/\text{s}}, \quad Q_2 = \mathbf{0.0111 \text{ m}^3/\text{s}}, \quad \text{and} \quad Q_3 = \mathbf{0.0163 \text{ m}^3/\text{s}} \quad \text{Ans. (a)}$$

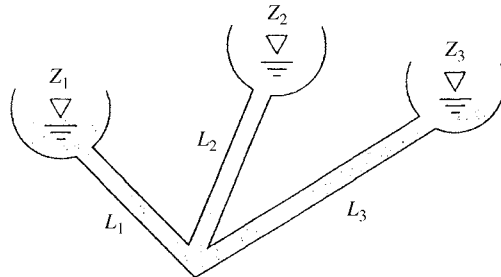
$$h_f = 51.4 \text{ m}, \quad \Delta p = \rho gh_f = (998 \text{ kg/m}^3)(9.81 \text{ m/s}^2)(51.4 \text{ m}) = \mathbf{503,000 \text{ Pa}} \quad \text{Ans. (b)}$$

**6.121** Consider the three-reservoir system of Fig. P6.121 with the following data:

$$L_1 = 95 \text{ m} \quad L_2 = 125 \text{ m} \quad L_3 = 160 \text{ m}$$

$$z_1 = 25 \text{ m} \quad z_2 = 115 \text{ m} \quad z_3 = 85 \text{ m}$$

All pipes are 28-cm-diameter unfinished concrete ( $\varepsilon = 1 \text{ mm}$ ). Compute the steady flow rate in all pipes for water at 20°C.



**Fig. P6.121**

**Solution:** For water at 20°C, take  $\rho = 998 \text{ kg/m}^3$  and  $\mu = 0.001 \text{ kg/m}\cdot\text{s}$ . All pipes have  $\varepsilon/d = 1/280 = 0.00357$ . Let the intersection be “a.” The head loss at “a” is desired:

$$z_1 - h_a = f_1 \frac{L_1}{d_1} \frac{V_1^2}{2g}; \quad z_2 - h_a = f_2 \frac{L_2}{d_2} \frac{V_2^2}{2g}; \quad z_3 - h_a = f_3 \frac{L_3}{d_3} \frac{V_3^2}{2g}$$

$$\text{plus the requirement that } Q_1 + Q_2 + Q_3 = 0 \quad \text{or, for same } d, \quad V_1 + V_2 + V_3 = 0$$

We guess  $h_a$  then iterate each friction factor to find  $V$  and  $Q$  and then check if  $\sum Q = 0$ .

$$h_a = 75 \text{ m: } 25 - 75 = (-)50 = f_1 \left( \frac{95}{0.28} \right) \frac{V_1^2}{2(9.81)}, \quad \text{solve } f_1 \approx 0.02754, \quad V_1 \approx -10.25 \frac{\text{m}}{\text{s}}$$

Similarly,  $115 - 75 = f_2(125/0.28) \left[ V_2^2/2(9.81) \right]$  gives  $f_2 \approx 0.02755$ .  $V_2 \approx +7.99$

and  $85 - 75 = f_3(160/0.28) \left[ V_3^2/2(9.81) \right]$

gives  $f_3 \approx 0.02762$ ,  $V_3 \approx +3.53 \frac{\text{m}}{\text{s}}$ ,  $\sum V = +1.27$

Repeating for  $h_a = 80 \text{ m}$  gives  $V_1 = -10.75$ ,  $V_2 = +7.47$ ,  $V_3 = +2.49 \text{ m/s}$ ,  $\sum V = -0.79$ .  
Interpolate to  $h_a \approx 78 \text{ m}$ , gives  $V_1 = -10.55 \text{ m/s}$ ,  $V_2 = +7.68 \text{ m/s}$ ,  $V_3 = +2.95 \text{ m/s}$ , or:

$$Q_1 = -0.65 \text{ m}^3/\text{s}, \quad Q_2 = +0.47 \text{ m}^3/\text{s}, \quad Q_3 = +0.18 \text{ m}^3/\text{s}. \quad \text{Ans.}$$


---

**6.122** Modify Prob. 6.121 by reducing the diameter to 15 cm, with  $\varepsilon = 1 \text{ mm}$ . Compute the flow rate in each pipe. They all reduce, compared to Prob. 6.121, by a factor of about 5.2. Can you explain this?

**Solution:** The roughness ratio increases to  $\varepsilon/d = 1/150 = 0.00667$ , and all  $L/d$ 's increase. Guess  $h_a = 75 \text{ m}$ : converges to  $f_1 = 0.0333$ ,  $f_2 = 0.0333$ ,  $f_4 = 0.0334$

and  $V_1 \approx -6.82 \text{ m/s}$ ,  $V_2 \approx +5.32 \text{ m/s}$ ,  $V_3 \approx +2.34 \text{ m/s}$ ,  $\sum V \approx +0.85$

We finally obtain  $h_a \approx 78.2 \text{ m}$ , giving  $V_1 = -7.04 \text{ m/s}$ ,  $V_2 = +5.10 \text{ m/s}$ ,  $V_3 = +1.94 \text{ m/s}$ ,  
or:  $Q_1 = -0.124 \text{ m}^3/\text{s}$ ,  $Q_2 = +0.090 \text{ m}^3/\text{s}$ ,  $Q_3 = +0.034 \text{ m}^3/\text{s}$ . *Ans.*

---

**6.123** Modify Prob. 6.121 on the previous page as follows. Let  $z_3$  be unknown and find its value such that the flow rate in pipe 3 is  $0.2 \text{ m}^3/\text{s}$  toward the junction. (This problem is best suited for computer iteration.)

**Solution:** For water at  $20^\circ\text{C}$ , take  $\rho = 998 \text{ kg/m}^3$  and  $\mu = 0.001 \text{ kg/m}\cdot\text{s}$ . All pipes have  $\varepsilon/d = 1/280 = 0.00357$ . Let the intersection be "a." The head loss at "a" is desired for each in order to check the flow rate in pipe 3.

In Prob. 6.121, with  $z_3 = 85 \text{ m}$ , we found  $Q_3$  to be  $0.18 \text{ m}^3/\text{s}$  toward the junction, pretty close. We repeat the procedure with a few new values of  $z_3$ , closing to  $\sum Q = 0$  each time:

Guess  $z_3 = 85 \text{ m}$ :  $h_a = 78.19 \text{ m}$ ,  $Q_1 = -0.6508$ ,  $Q_2 = +0.4718$ ,  $Q_3 = +0.1790 \text{ m}^3/\text{s}$

90 m:  $80.65 \text{ m}$ ,  $-0.6657$ ,  $+0.6657$ ,  $+0.2099 \text{ m}^3/\text{s}$

Interpolate:  $h_a \approx 79.89$ ,  $Q_1 \approx -0.6611$ ,

$Q_2 \approx +0.4608$ ,  $Q_3 \approx +0.200 \text{ m}^3/\text{s}$ ,  $z_3 \approx 88.4 \text{ m}$  *Ans.*

---

**6.124** The three-reservoir system in Fig. P6.124 delivers water at 20°C. The system data are as follows:

$$D_1 = 8 \text{ in} \quad D_2 = 6 \text{ in} \quad D_3 = 9 \text{ in}$$

$$L_1 = 1800 \text{ ft} \quad L_2 = 1200 \text{ ft} \quad L_3 = 1600 \text{ ft}$$

All pipes are galvanized iron. Compute the flow rate in all pipes.

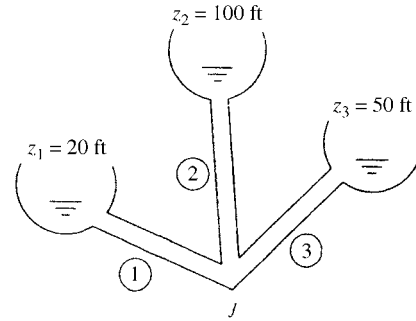


Fig. P6.124

**Solution:** For water at 20°C, take  $\rho = 1.94 \text{ slug/ft}^3$  and  $\mu = 2.09\text{E-}5 \text{ slug/ft}\cdot\text{s}$ . For galvanized iron, take  $\varepsilon = 0.0005 \text{ ft}$ . Then the roughness ratios are

$$\varepsilon/d_1 = 0.00075 \quad \varepsilon/d_2 = 0.0010 \quad \varepsilon/d_3 = 0.00667$$

Let the intersection be “a.” The head loss at “a” is desired:

$$z_1 - h_a = \frac{f_1 L_1}{d_1} \frac{V_1^2}{2g}; \quad z_2 - h_a = \frac{f_2 L_2}{d_2} \frac{V_2^2}{2g}; \quad z_3 - h_a = \frac{f_3 L_3}{d_3} \frac{V_3^2}{2g}; \quad \text{plus } Q_1 + Q_2 + Q_3 = 0$$

We guess  $h_a$  then iterate each friction factor to find  $V$  and  $Q$  and then check if  $\sum Q = 0$ .

$$\text{Guess } h_a = 50 \text{ ft: } 20 - 50 = (-)30 \text{ ft} = \frac{f_1 (1800) V_1^2}{(8/12) 2 (32.2)},$$

$$\text{solve } f_1 = 0.0194, \quad V_1 = -6.09 \frac{\text{ft}}{\text{s}}$$

Similarly,  $f_2 = 0.0204$ ,  $V_2 \approx +8.11 \text{ ft/s}$  and of course  $V_3 = 0$ . Get  $\sum Q = -0.54 \text{ ft}^3/\text{s}$

Try again with a slightly lower  $h_a$  to reduce  $Q_1$  and increase  $Q_2$  and  $Q_3$ :

$$h_a = 48 \text{ ft: } \text{converges to } Q_1 = -2.05 \frac{\text{ft}^3}{\text{s}}, \quad Q_2 = +1.62 \frac{\text{ft}^3}{\text{s}},$$

$$Q_3 = +0.76 \frac{\text{ft}^3}{\text{s}}, \quad \sum Q = +0.33$$

Interpolate to

$$h_a = 49.12 \text{ ft: } Q_1 = -2.09 \text{ ft}^3/\text{s}, \quad Q_2 = +1.61 \text{ ft}^3/\text{s}, \quad Q_3 = +0.49 \text{ ft}^3/\text{s} \quad \text{Ans.}$$

**6.125** Suppose that the three cast-iron pipes in Prob. 6.120 are instead connected to meet smoothly at a point B, as shown in Fig. P6.125. The inlet pressures in each pipe are:  $p_1 = 200$  kPa;  $p_2 = 160$  kPa;  $p_3 = 100$  kPa. The fluid is water at  $20^\circ\text{C}$ . Neglect minor losses. Estimate the flow rate in each pipe and whether it is toward or away from point B.

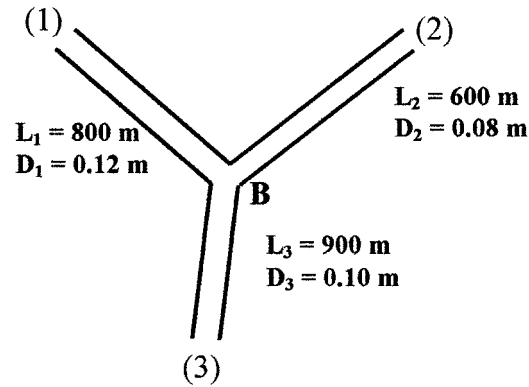


Fig. P6.125

**Solution:** For water take  $\rho = 998$  kg/m<sup>3</sup> and  $\mu = 0.001$  kg/m·s. The pressure at point B must be a known (constant) value which makes the net flow rate equal to zero at junction B. The flow clearly goes from (1) to B, and from B to (3), but we are not sure about pipe (2). For cast iron (Table 6.1),  $\varepsilon = 0.26$  mm. Each pipe has a flow rate based upon its pressure drop:

$$p_1 - p_B = f_1 \frac{L_1}{D_1} \frac{\rho V_1^2}{2}; \quad |p_2 - p_B| = f_2 \frac{L_2}{D_2} \frac{\rho V_2^2}{2}; \quad p_B - p_3 = f_3 \frac{L_3}{D_3} \frac{\rho V_3^2}{2}$$

where the  $f$ 's are determined from the Moody chart for each pipe's  $\varepsilon/D$  and  $\text{Re}_D$ . The correct value of  $p_B$  makes the flow rates  $Q_i = (\pi/4)D_i^2 V_i$  balance at junction B. EES is excellent for this type of iteration, and the final results balance for  $p_B = 166.7$  kPa:

$$f_1 = 0.0260; \quad \text{Re}_1 = 74300; \quad \varepsilon/D_1 = 0.00217; \quad Q_1 = +0.00701 \text{ m}^3/\text{s} \text{ (toward B)}$$

$$f_2 = 0.0321; \quad \text{Re}_2 = 18900; \quad \varepsilon/D_2 = 0.00325; \quad Q_2 = -0.00119 \text{ m}^3/\text{s} \text{ (away from B) } \textit{Ans.}$$

$$f_3 = 0.0270; \quad \text{Re}_3 = 74000; \quad \varepsilon/D_3 = 0.00260; \quad Q_3 = -0.00582 \text{ m}^3/\text{s} \text{ (away from B)}$$

**6.126** Modify Prob. 6.124 as follows. Let all data be the same except that pipe 1 is fitted with a butterfly valve (Fig. 6.19b). Estimate the proper valve opening angle (in degrees) for the flow rate through pipe 1 to be reduced to  $1.5$  ft<sup>3</sup>/s toward reservoir 1. (This problem requires iteration and is best suited to a digital computer.)

**Solution:** For water at  $20^\circ\text{C}$ , take  $\rho = 1.94$  slug/ft<sup>3</sup> and  $\mu = 2.09\text{E}-4$  slug/ft·s. For galvanized iron, take  $\varepsilon = 0.0005$  ft. Then the roughness ratios are

$$\varepsilon/d_1 = 0.00075 \quad \varepsilon/d_2 = 0.0010 \quad \varepsilon/d_3 = 0.00667$$



For a butterfly valve loss coefficient “K” (to be found). Let the junction be “J.” The head loss at “J” is desired and then to be iterated to give the proper flow rate in pipe (1):

$$z_1 - h_J = \frac{V_1^2}{2g} \left( f \frac{L}{d} + K \right)_1 ; \quad z_2 - h_J = \frac{V_2^2}{2g} \left( f \frac{L}{d} \right)_2 ;$$

$$z_3 - h_J = \frac{V_3^2}{2g} \left( f \frac{L}{d} \right)_3 ; \quad \text{and} \quad Q_1 + Q_2 + Q_3 = 0$$

We know  $z_1 = 20$  ft,  $z_2 = 100$  ft, and  $z_3 = 50$  ft. From Prob. 6.124, where  $K = 0$ , the flow rate was  $2.09 \text{ ft}^3/\text{s}$  toward reservoir 1. Now guess a finite value of K and repeat:

$K = 40$ : converges to  $h_J = 50.0$ ,  $Q_1 = -1.59 \text{ ft}^3/\text{s}$ ,  $Q_2 = +1.59 \text{ ft}^3/\text{s}$ ;  $Q_3 \approx 0$

$K = 50$ : converges to  $h_J = 50.03$  ft,  $Q_1 = -1.513$ ,  $Q_2 = +1.591$ ,  $Q_3 = -0.078$

$K = 52$ : gives  $h_J = 50.04$  ft,  $Q_1 = -1.500 \text{ ft}^3/\text{s}$ ,  $Q_2 = 1.591$ ,  $Q_3 = -0.091$  Ans.

From Fig. 6.19b, a butterfly valve coefficient  $K \approx 52$  occurs at  $\theta_{\text{opening}} \approx 35^\circ$ . Ans.

**6.127** In the five-pipe horizontal network of Fig. P6.127, assume that all pipes have a friction factor  $f = 0.025$ . For the given inlet and exit flow rate of  $2 \text{ ft}^3/\text{s}$  of water at  $20^\circ\text{C}$ , determine the flow rate and direction in all pipes. If  $p_A = 120 \text{ lbf/in}^2$  gage, determine the pressures at points B, C, and D.

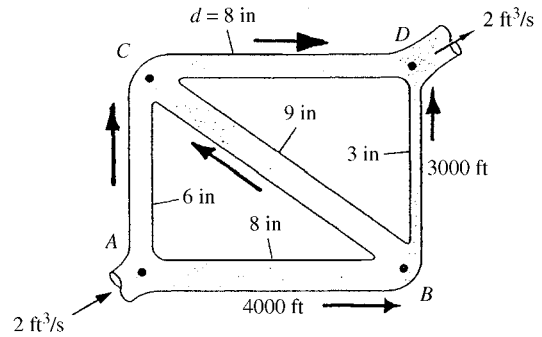


Fig. P6.127

**Solution:** For water at  $20^\circ\text{C}$ , take  $\rho = 1.94 \text{ slug/ft}^3$  and  $\mu = 2.09\text{E}-5 \text{ slug/ft}\cdot\text{s}$ . Each pipe has a head loss which is known except for the square of the flow rate:

$$\text{Pipe AC: } h_f = \frac{8fLQ^2}{\pi^2gd^5} \Big|_{AC} = \frac{8(0.025)(3000)Q_{AC}^2}{\pi^2(32.2)(6/12)^5} = K_{AC}Q_{AC}^2, \quad \text{where } K_{AC} \approx 60.42$$

$$\text{Similarly, } K_{AB} = 19.12, \quad K_{BC} = 13.26, \quad K_{CD} = 19.12, \quad K_{BD} = 1933. \quad \left( Q \text{ in } \frac{\text{ft}^3}{\text{s}} \right)$$

There are two triangular closed loops, and the total head loss must be zero for each. Using the flow directions assumed on the figure P6.127 above, we have

$$\text{Loop A-B-C: } 19.12Q_{AB}^2 + 13.26Q_{BC}^2 - 60.42Q_{AC}^2 = 0$$

$$\text{Loop B-C-D: } 13.26Q_{BC}^2 + 19.12Q_{CD}^2 - 1933.0Q_{BD}^2 = 0$$

And there are three independent junctions which have zero net flow rate:

$$\text{Junction A: } Q_{AB} + Q_{AC} = 2.0; \quad \text{B: } Q_{AB} = Q_{BC} + Q_{BD}; \quad \text{C: } Q_{AC} + Q_{BC} = Q_{CD}$$

These are five algebraic equations to be solved for the five flow rates. The answers are:

$$Q_{AB} = \mathbf{1.19}, \quad Q_{AC} = \mathbf{0.81}, \quad Q_{BC} = \mathbf{0.99}, \quad Q_{CD} = \mathbf{1.80}, \quad Q_{BD} = \mathbf{0.20} \frac{\text{ft}^3}{\text{s}} \quad \text{Ans. (a)}$$

The pressures follow by starting at A (120 psi) and subtracting off the friction losses:

$$p_B = p_A - \rho g K_{AB} Q_{AB}^2 = 120 \times 144 - 62.4(19.12)(1.19)^2$$

$$p_B = 15590 \text{ psf} \div 144 = \mathbf{108} \frac{\text{lbf}}{\text{in}^2}$$

$$\text{Similarly, } p_C \approx \mathbf{103} \text{ psi} \quad \text{and} \quad p_D \approx \mathbf{76} \text{ psi} \quad \text{Ans. (b)}$$

**6.128** Modify Prob. 6.127 above as follows: Let the inlet flow at A and the exit flow at D be unknown. Let  $p_A - p_B = 100$  psi. Compute the flow rate in all five pipes.

**Solution:** Our head loss coefficients “K” from above are all the same. Head loss AB is known, plus we have two “loop” equations and two “junction” equations:

$$\frac{p_A - p_B}{\rho g} = \frac{100 \times 144}{62.4} = 231 \text{ ft} = K_{AB} Q_{AB}^2 = 19.12 Q_{AB}^2, \quad \text{or} \quad Q_{AB} = \mathbf{3.47} \frac{\text{ft}^3}{\text{s}}$$

$$\text{Two loops: } 231 + 13.26 Q_{BC}^2 - 60.42 Q_{AC}^2 = 0$$

$$13.26 Q_{BC}^2 + 19.12 Q_{CD}^2 - 1933.0 Q_{BD}^2 = 0$$

$$\text{Two junctions: } Q_{AB} = 3.47 = Q_{BC} + Q_{BD}; \quad Q_{AC} + Q_{BC} = Q_{CD}$$

The solutions are in exactly the same ratio as the lower flow rates in Prob. 6.127:

$$Q_{AB} = \mathbf{3.47} \frac{\text{ft}^3}{\text{s}}, \quad Q_{BC} = \mathbf{2.90} \frac{\text{ft}^3}{\text{s}}, \quad Q_{BD} = \mathbf{0.58} \frac{\text{ft}^3}{\text{s}},$$

$$Q_{CD} = \mathbf{5.28} \frac{\text{ft}^3}{\text{s}}, \quad Q_{AC} = \mathbf{2.38} \frac{\text{ft}^3}{\text{s}} \quad \text{Ans.}$$

**6.129** In Fig. P6.129 all four horizontal cast-iron pipes are 45 m long and 8 cm in diameter and meet at junction *a*, delivering water at 20°C. The pressures are known at four points as shown:

$$\begin{aligned} p_1 &= 950 \text{ kPa} & p_2 &= 350 \text{ kPa} \\ p_3 &= 675 \text{ kPa} & p_4 &= 100 \text{ kPa} \end{aligned}$$

Neglecting minor losses, determine the flow rate in each pipe.

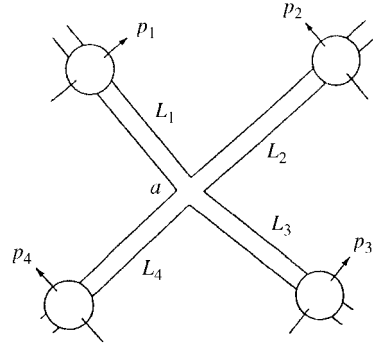


Fig. P6.129

**Solution:** For water at 20°C, take  $\rho = 998 \text{ kg/m}^3$  and  $\mu = 0.001 \text{ kg/m}\cdot\text{s}$ . All pipes are cast iron, with  $\epsilon/d = 0.26/80 = 0.00325$ . All pipes have  $L/d = 45/0.08 = 562.5$ . One solution method is to guess the junction pressure  $p_a$ , iterate to calculate the friction factors and flow rates, and check to see if the net junction flow is zero:

$$\text{Guess } p_a = 500 \text{ kPa: } h_{f1} = \frac{950000 - 500000}{998(9.81)} = 45.96 \text{ m} = \frac{8f_1L_1Q_1^2}{\pi^2gd_1^5} = 1.135E6f_1Q_1^2$$

$$\text{then guess } f_1 \approx 0.02, \quad Q_1 = 0.045 \text{ m}^3/\text{s}, \quad Re_1 = 4\rho Q_1/(\pi\mu d_1) = 715000, \quad f_{1\text{-new}} \approx 0.0269$$

$$\text{converges to } f_1 \approx 0.0270, \quad Q_1 \approx 0.0388 \text{ m}^3/\text{s}$$

$$\text{Iterate also to } Q_2 = -0.0223 \frac{\text{m}^3}{\text{s}} \text{ (away from } a), \quad Q_3 = 0.0241, \quad Q_4 = -0.0365$$

$$\Sigma Q = +0.00403, \quad \text{so we have guessed } p_a \text{ a little low.}$$

Trying  $p_a = 530 \text{ kPa}$  gives  $\Sigma Q = -0.00296$ , hence iterate to  $p_a \approx 517 \text{ kPa}$ :

$$Q_1 = +0.0380 \frac{\text{m}^3}{\text{s}} \text{ (toward } a), \quad Q_2 = -0.0236 \frac{\text{m}^3}{\text{s}},$$

$$Q_3 = +0.0229 \frac{\text{m}^3}{\text{s}}, \quad Q_4 = -0.0373 \frac{\text{m}^3}{\text{s}} \quad \text{Ans.}$$

**6.130** In Fig. P6.130 lengths *AB* and *BD* are 2000 and 1500 ft, respectively. The friction factor is 0.022 everywhere, and  $p_A = 90 \text{ lbf/in}^2$  gage. All pipes have a diameter of 6 in. For water at 20°C, determine the flow rate in all pipes and the pressures at points *B*, *C*, and *D*.

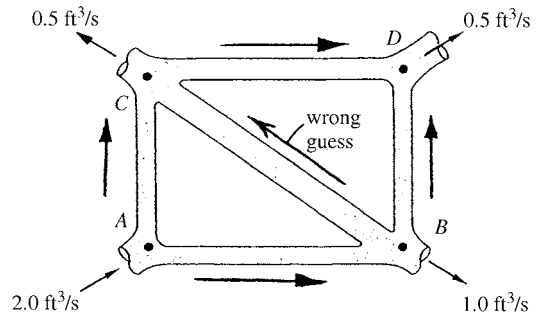


Fig. P6.130

**Solution:** For water at 20°C, take  $\rho = 1.94$  slug/ft<sup>3</sup> and  $\mu = 2.09\text{E-}5$  slug/ft·s. Each pipe has a head loss which is known except for the square of the flow rate:

$$\text{Pipe AC: } h_f = \frac{8fLQ^2}{\pi^2 g d^5} = \frac{8(0.022)(1500)Q_{AC}^2}{\pi^2 (32.2)(6/12)^5} = K_{AC} Q_{AC}^2, \quad \text{where } K_{AC} \approx \mathbf{26.58}$$

$$\text{Similarly, } K_{AB} = K_{CD} = 35.44, K_{BD} = 26.58, \text{ and } K_{BC} = 44.30.$$

The solution is similar to Prob. 6.127, except that (1) the  $K$ 's are different; and (2) junctions B and C have additional flow leaving the network. The basic flow relations are:

$$\text{Loop ABC: } 35.44Q_{AB}^2 + 44.3Q_{BC}^2 - 26.58Q_{AC}^2 = 0$$

$$\text{Loop BCD: } 44.3Q_{BC}^2 + 35.44Q_{CD}^2 - 26.58Q_{BD}^2 = 0$$

$$\text{Junctions A,B,C: } Q_{AB} + Q_{AC} = 2.0;$$

$$Q_{AB} = Q_{BC} + Q_{BD} + 1.0; \quad Q_{AC} + Q_{BC} = Q_{CD} + 0.5$$

In this era of PC “equation solvers” such as MathCAD, etc., it is probably not necessary to dwell upon any solution methods. For hand work, one might guess  $Q_{AB}$ , then the other four are obtained in sequence from the above relations, plus a check on the original guess for  $Q_{AB}$ . The assumed arrows are shown above. It turns out that we have guessed the direction incorrectly on  $Q_{BC}$  above, but the others are OK. The final results are:

$$Q_{AB} = \mathbf{0.949 \text{ ft}^3/\text{s}} \text{ (toward B); } \quad Q_{AC} = \mathbf{1.051 \text{ ft}^3/\text{s}} \text{ (toward C)}$$

$$Q_{BC} = \mathbf{0.239} \text{ (toward B); } \quad Q_{CD} = \mathbf{0.312} \text{ (toward D); } \quad Q_{BD} = \mathbf{0.188} \text{ (to D)} \quad \text{Ans. (a)}$$

The pressures start at A, from which we subtract the friction losses in each pipe:

$$p_B = p_A - \rho g K_{AB} Q_{AB}^2 = 90 \times 144 - 62.4(35.44)(0.949)^2 = 10969 \text{ psf} \div 144 = \mathbf{76 \text{ psi}}$$

$$\text{Similarly, we obtain } p_C = 11127 \text{ psf} = \mathbf{77 \text{ psi}; } \quad p_D = 10911 \text{ psf} \approx \mathbf{76 \text{ psi}} \quad \text{Ans. (b)}$$

**6.131** A water-tunnel test section has a 1-m diameter and flow properties  $V = 20$  m/s,  $p = 100$  kPa, and  $T = 20^\circ\text{C}$ . The boundary-layer blockage at the end of the section is 9 percent. If a conical diffuser is to be added at the end of the section to achieve maximum pressure recovery, what should its angle, length, exit diameter, and exit pressure be?

**Solution:** For water at 20°C, take  $\rho = 998$  kg/m<sup>3</sup> and  $\mu = 0.001$  kg/m·s. The Reynolds number is very high,  $Re = \rho V d / \mu = (998)(20)(1)/(0.001) \approx 2.0\text{E}7$ ; much higher than the diffuser data in Fig. 6.28b ( $Re \approx 1.2\text{E}5$ ). But what can we do (?) Let's use it anyway:

$$B_t = 0.09, \quad \text{read } C_{p,\max} \approx 0.71 \quad \text{at } L/d \approx 25, \quad 2\theta \approx 4^\circ, \quad AR \approx 8:$$

Then  $\theta_{\text{cone}} \approx 2^\circ$ ,  $L \approx 25d \approx \mathbf{25\ m}$ ,  $D_{\text{exit}} = d(8)^{1/2} \approx \mathbf{2.8\ m}$  *Ans.* (a)

$$C_p \approx 0.71 = \frac{p_e - p_t}{(1/2)\rho V_t^2} = \frac{p_e - 100000}{(1/2)(998)(20)^2}, \quad \text{or: } p_{\text{exit}} \approx \mathbf{242000\ Pa} \quad \text{Ans. (b)}$$

**6.132** For Prob. 6.131, suppose we are limited by space to a total diffuser length of 10 meters. What should be the diffuser angle, exit diameter, and exit pressure for maximum recovery?

**Solution:** We are limited to  $L/D = 10.0$ . From Fig. 6.28b, read  $C_{p,\text{max}} \approx 0.62$  at  $AR \approx 4$  and  $2\theta \approx 6^\circ$ . *Ans.* The exit diameter and pressure are

$$D_e = d\sqrt{(AR)} = (1.0)(4.0)^{1/2} \approx \mathbf{2.0\ m} \quad \text{Ans.}$$

$$C_{p,\text{max}} \approx 0.62 = (p_e - 100000)/[(1/2)(998)(20)^2], \quad \text{or: } p_{\text{exit}} \approx \mathbf{224000\ Pa} \quad \text{Ans.}$$

**6.133** A wind-tunnel test section is 3 ft square with flow properties  $V = 150\ \text{ft/s}$ ,  $p = 15\ \text{lbf/in}^2$  absolute, and  $T = 68^\circ\text{F}$ . Boundary-layer blockage at the end of the test section is 8 percent. Find the angle, length, exit height, and exit pressure of a flat-walled diffuser added onto the section to achieve maximum pressure recovery.

**Solution:** For air at  $20^\circ\text{C}$  and 15 psi, take  $\rho = 0.00238\ \text{slug/ft}^3$  and  $\mu = 3.76\text{E-}7\ \text{slug/ft}\cdot\text{s}$ . The Reynolds number is rather high,  $Re = \rho V d / \mu = (0.00238)(150)(3)/(3.76\text{E-}7) \approx 2.9\text{E}6$ ; much higher than the diffuser data in Fig. 6.28a ( $Re \approx 2.8\text{E}5$ ). But what can we do (?) Let's use it anyway:

$$B_t = 0.08, \quad \text{read } C_{p,\text{max}} \approx 0.70 \quad \text{at } L/W_1 \approx 17, \quad 2\theta \approx 9.5^\circ, \quad AR \approx 3.75:$$

Then  $\theta_{\text{best}} \approx \mathbf{4.75^\circ}$ ,  $L \approx 17W_1 \approx \mathbf{51\ ft}$ ,  $W_2 \approx (AR)W_1 = 3.75(3) \approx \mathbf{11\ ft}$  *Ans.*

$$C_p \approx 0.70 = \frac{p_e - p_t}{(1/2)\rho V_1^2} = \frac{p_e - 15 \times 144}{(1/2)(0.00238)(150)^2}, \quad \text{or: } p_{\text{exit}} \approx \mathbf{2180\ \frac{lbf}{ft^2}} \quad \text{Ans.}$$

**6.134** For Prob. 6.133 above, suppose we are limited by space to a total diffuser length of 30 ft. What should the diffuser angle, exit height, and exit pressure be for maximum recovery?

**Solution:** We are limited to  $L/W_1 = 10.0$ . From Fig. 6.28a, read  $C_{p,\max} \approx 0.645$  at  $AR \approx 2.8$  and  $2\theta \approx 10^\circ$ . *Ans.* The exit height and pressure are

$$W_{1,e} = (AR)W_1 = (2.8)(3.0) \approx \mathbf{8.4 \text{ ft}} \quad \text{Ans.}$$

$$C_{p,\max} \approx 0.645 = [p_e - (15)144] / [(1/2)(0.00238)(150)^2], \quad \text{or} \quad p_e = \mathbf{2180 \frac{\text{lbf}}{\text{ft}^2}} \quad \text{Ans.}$$

**6.135** An airplane uses a pitot-static tube as a velocimeter. The measurements, with their uncertainties, are a static temperature of  $(-11 \pm 3)^\circ\text{C}$ , a static pressure of  $60 \pm 2 \text{ kPa}$ , and a pressure difference  $(p_o - p_s) = 3200 \pm 60 \text{ Pa}$ . (a) Estimate the airplane's velocity and its uncertainty. (b) Is a compressibility correction needed?

**Solution:** The air density is  $\rho = p/(RT) = (60000 \text{ Pa}) / [(287 \text{ m}^2/\text{s}^2 \cdot \text{K})(262 \text{ K})] = 0.798 \text{ kg/m}^3$ . (a) Estimate the velocity from the incompressible Pitot formula, Eq. (6.97):

$$V = \sqrt{\frac{2\Delta p}{\rho}} = \sqrt{\frac{2\Delta p}{p/(RT)}} = \sqrt{\frac{2(3200 \text{ Pa})}{0.798 \text{ kg/m}^3}} = 90 \frac{\text{m}}{\text{s}}$$

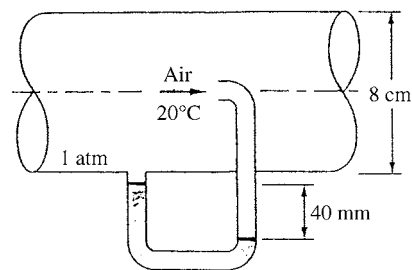
The overall uncertainty involves pressure difference, absolute pressure, and absolute temperature:

$$\frac{\delta V}{V} = \left[ \left( \frac{1}{2} \frac{\delta \Delta p}{\Delta p} \right)^2 + \left( \frac{1}{2} \frac{\delta p}{p} \right)^2 + \left( \frac{1}{2} \frac{\delta T}{T} \right)^2 \right]^{1/2} = \frac{1}{2} \left[ \left( \frac{60}{3200} \right)^2 + \left( \frac{2}{60} \right)^2 + \left( \frac{3}{262} \right)^2 \right]^{1/2} = 0.020$$

The uncertainty in velocity is 2%, therefore our final estimate is  $V \approx \mathbf{90 \pm 2 \text{ m/s}}$  *Ans.* (a) Check the Mach number. The speed of sound is  $a = (kRT)^{1/2} = [1.4(287)(262)]^{1/2} = 324 \text{ m/s}$ . Therefore

$$Ma = V/a = 90/324 = 0.28 < 0.3. \quad \mathbf{\text{No compressibility correction is needed.}} \quad \text{Ans. (b)}$$

**6.136** For the pitot-static pressure arrangement of Fig. P6.136, the manometer fluid is (colored) water at  $20^\circ\text{C}$ . Estimate (a) the centerline velocity, (b) the pipe volume flow, and (c) the (smooth) wall shear stress.



**Fig. P6.136**

**Solution:** For air at 20°C and 1 atm, take  $\rho = 1.2 \text{ kg/m}^3$  and  $\mu = 1.8\text{E-}5 \text{ kg/m}\cdot\text{s}$ . For water at 20°C, take  $\rho = 998 \text{ kg/m}^3$  and  $\mu = 0.001 \text{ kg/m}\cdot\text{s}$ . The manometer reads

$$p_o - p = (\rho_{\text{water}} - \rho_{\text{air}})gh = (998 - 1.2)(9.81)(0.040) \approx 391 \text{ Pa}$$

$$\text{Therefore } V_{\text{CL}} = [2\Delta p/\rho]^{1/2} = [2(391)/1.2]^{1/2} \approx \mathbf{25.5 \text{ m/s}} \quad \text{Ans. (a)}$$

We can estimate the friction factor and then compute average velocity from Eq. (6.43):

$$\text{Guess } V_{\text{avg}} \approx 0.85V_{\text{CL}} \approx 21.7 \frac{\text{m}}{\text{s}}, \quad \text{then } \text{Re}_d = \frac{\rho V d}{\mu} = \frac{1.2(21.7)(0.08)}{1.8\text{E-}5} \approx 115,700$$

$$\text{Then } f_{\text{smooth}} \approx 0.0175, \quad V_{\text{better}} = \frac{25.5}{[1 + 1.33\sqrt{0.0175}]} \approx 21.69 \frac{\text{m}}{\text{s}} \quad (\text{converged})$$

$$\text{Thus the volume flow is } Q = (\pi/4)(0.08)^2(21.69) \approx \mathbf{0.109 \text{ m}^3/\text{s}}. \quad \text{Ans. (b)}$$

$$\text{Finally, } \tau_w = \frac{f}{8}\rho V^2 = \frac{0.0175}{8}(1.2)(21.69)^2 \approx \mathbf{1.23 \text{ Pa}} \quad \text{Ans. (c)}$$

**6.137** For the 20°C water flow of Fig. P6.137, use the pitot-static arrangement to estimate (a) the centerline velocity and (b) the volume flow in the 5-in-diameter smooth pipe. (c) What error in flow rate is caused by neglecting the 1-ft elevation difference?

**Solution:** For water at 20°C, take  $\rho = 1.94 \text{ slug/ft}^3$  and  $\mu = 2.09\text{E-}5 \text{ slug/ft}\cdot\text{s}$ . For the manometer reading  $h = 2$  inches,

$$p_{oB} - p_A = (SG_{\text{merc}} - 1)(\rho g)_{\text{water}} h$$

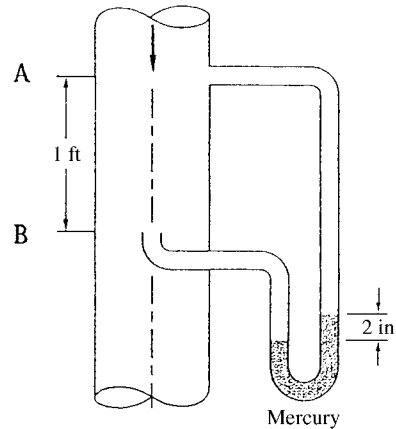
$$+ \rho_{\text{water}} g(1 \text{ ft}) \quad \text{but from the energy equation,}$$

$$p_A - p_B = \rho_{\text{water}} g h_{f-AB} - \rho_{\text{water}} g(1 \text{ ft}) \quad \text{Therefore } p_{oB} - p_B = (SG - 1)\rho g h_{\text{mano}} + \rho g h_{f-AB}$$

$$\text{where friction loss } h_{f-AB} \approx f(\Delta L/d)(V^2/2g)$$

Thus the pitot tube reading equals the manometer reading (of about 130 psf) plus the friction loss between A and B (which is only about 3 psf), so there is only a small error:

$$(SG - 1)\rho g h = (13.56 - 1)(62.4)(2/12) \approx 130.6 \text{ psf}, \quad V_{\text{CL}} \approx \left[ \frac{2\Delta p}{\rho} \right]^{1/2} = \left[ \frac{2(130.6)}{1.94} \right]^{1/2}$$



**Fig. P6.137**

$$\text{or } V_{CL} \approx 11.6 \frac{\text{ft}}{\text{s}}, \text{ so } V_{\text{avg}} \approx 0.85V_{CL} \approx 9.9 \frac{\text{ft}}{\text{s}}, \text{ Re} = \frac{1.94(9.9)(5/12)}{2.09E-5} \approx 381500,$$

$$\text{so } f_{\text{smooth}} \approx 0.0138, \text{ or } \Delta p_{\text{friction}} = f(L/d)\rho V^2/2 \approx 3.2 \text{ lbf/ft}^2$$

If we now correct the pitot tube reading to  $\Delta p_{\text{pitot}} \approx 130.6 + 3.2 = 133.8$  psf, we may iterate and converge rapidly to the final estimate:

$$f \approx 0.01375, V_{CL} \approx \mathbf{11.75 \frac{\text{ft}}{\text{s}}}; \quad Q \approx \mathbf{1.39 \frac{\text{ft}^3}{\text{s}}}; \quad V_{\text{avg}} \approx \mathbf{10.17 \frac{\text{ft}}{\text{s}}} \quad \text{Ans. (a, b)}$$

The error compared to our earlier estimate  $V \approx 9.91$  ft/s is about **2.6%** Ans.(c)

**6.138** An engineer who took college fluid mechanics on a pass-fail basis has placed the static pressure hole far upstream of the stagnation probe, as in Fig. P6.138, thus contaminating the pitot measurement ridiculously with pipe friction losses. If the pipe flow is air at 20°C and 1 atm and the manometer fluid is Meriam red oil (SG = 0.827), estimate the air centerline velocity for the given manometer reading of 16 cm. Assume a smooth-walled tube.

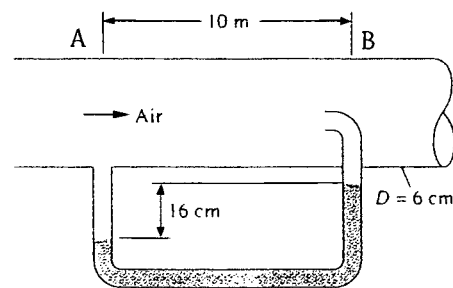


Fig. P6.138

**Solution:** For air at 20°C and 1 atm, take  $\rho = 1.2 \text{ kg/m}^3$  and  $\mu = 1.8E-5 \text{ kg/m}\cdot\text{s}$ . Because of the high friction loss over 10 meters of length, the manometer actually shows  $p_{oB}$  less than  $p_A$ , which is a bit weird but correct:

$$p_A - p_{oB} = (\rho_{\text{mano}} - \rho_{\text{air}})gh = [0.827(998) - 1.2](9.81)(0.16) \approx 1294 \text{ Pa}$$

$$\text{Meanwhile, } p_A - p_B = \rho gh_f = f \frac{L}{d} \frac{\rho V^2}{2}, \text{ or } p_{oB} - p_B = \frac{fL}{d} \frac{\rho V^2}{2} - 1294 = \frac{\rho}{2} V_{CL}^2$$

$$\text{Guess } f \approx 0.02, \quad V \approx 0.85V_{CL}, \quad \text{whence } 0.02 \left( \frac{10}{0.06} \right) \left( \frac{1.2}{2} \right) V^2 - 1294 = \frac{1.2}{2} \left( \frac{V}{0.85} \right)^2$$

$$\text{Solve for } V \approx 33.3 \frac{\text{m}}{\text{s}}, \quad \text{Re}_d = \frac{1.2(33.3)(0.06)}{1.8E-5} \approx 133000, \quad f_{\text{better}} \approx 0.0170,$$

$$V \approx V_{CL} [1 + 1.33\sqrt{f}] \approx 0.852V_{CL}, \quad \text{repeat to convergence}$$

Finally converges,  $f \approx 0.0164$ ,  $V \approx 39.87 \text{ m/s}$ ,  $V_{CL} = V/0.8546 \approx \mathbf{46.65 \text{ m/s}}$ . Ans.



**6.139** Professor Walter Tunnel must measure velocity in a water tunnel. Due to budgetary restrictions, he cannot afford a pitot-static tube, so he inserts a total-head probe and a static-head probe, as shown, both in the mainstream away from the wall boundary layers. The two probes are connected to a manometer. (a) Write an expression for tunnel velocity  $V$  in terms of the parameters in the figure. (b) Is it critical that  $h_1$  be measured accurately? (c) How does part (a) differ from a pitot-static tube formula?

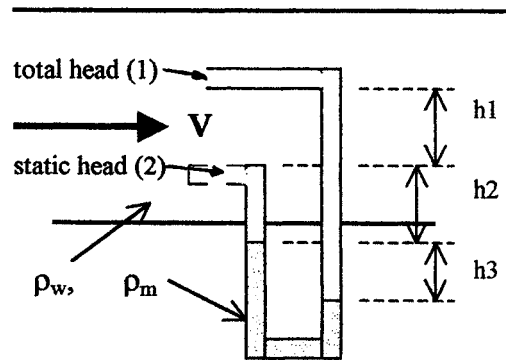


Fig. P6.139

**Solution:** Write Bernoulli from total-head inlet (1) to static-head inlet (2):

$$p_o + \rho_w g z_1 = p_s + \frac{\rho_w}{2} V^2 + \rho_w g z_2, \quad \text{Solve } V = \sqrt{\frac{2(p_o - p_s + \rho_w g h_1)}{\rho_w}}$$

Combine this with hydrostatics through the manometer:

$$p_s + \rho_w g h_2 + \rho_m g h_3 = p_o + \rho_w g h_1 + \rho_w g h_2 + \rho_w g h_3, \quad \text{cancel out } \rho_w g h_2$$

$$\text{or: } p_o - p_s + \rho_w g h_1 = (\rho_m - \rho_w) g h_3$$

Introduce this into the expression for  $V$  above, for the final result:

$$V_{\text{tunnel}} = \sqrt{\frac{2(\rho_m - \rho_w) g h_3}{\rho_w}} \quad \text{Ans. (a)}$$

**This is exactly the same as a pitot-static tube— $h_1$  is not important.** Ans. (b, c)

**6.140** Kerosene at  $20^\circ\text{C}$  flows at  $18 \text{ m}^3/\text{h}$  in a 5-cm-diameter pipe. If a 2-cm-diameter thin-plate orifice with corner taps is installed, what will the measured pressure drop be, in Pa?

**Solution:** For kerosene at  $20^\circ\text{C}$ , take  $\rho = 804 \text{ kg/m}^3$  and  $\mu = 1.92\text{E-}3 \text{ kg/m}\cdot\text{s}$ . The orifice beta ratio is  $\beta = 2/5 = 0.4$ . The pipe velocity and Reynolds number are:

$$V = \frac{Q}{A} = \frac{18/3600}{(\pi/4)(0.05)^2} = 2.55 \frac{\text{m}}{\text{s}}, \quad \text{Re} = \frac{804(2.55)(0.05)}{1.92\text{E-}3} = 53300$$

From Eqs. (6.112) and (6.113a) [corner taps], estimate  $C_d \approx 0.6030$ . Then the orifice

pressure-drop formula predicts

$$Q = \frac{18}{3600} = 0.6030 \frac{\pi}{4} (0.02)^2 \sqrt{\frac{2\Delta p}{804[1-(0.4)^4]}}, \quad \text{solve } \Delta p \approx \mathbf{273 \text{ kPa}} \quad \text{Ans.}$$

**6.141** Gasoline at 20°C flows at 105 m<sup>3</sup>/h in a 10-cm-diameter pipe. We wish to meter the flow with a thin-plate orifice and a differential pressure transducer which reads best at about 55 kPa. What is the proper  $\beta$  ratio for the orifice?

**Solution:** For gasoline at 20°C, take  $\rho = 680 \text{ kg/m}^3$  and  $\mu = 2.92\text{E-}4 \text{ kg/m}\cdot\text{s}$ . This problem is similar to Example 6.21 in the text, but we don't have to be so precise because we don't know the exact geometry: corner taps,  $D:\frac{1}{2}D$  taps, etc. The pipe velocity is

$$V_1 = \frac{Q}{A_1} = \frac{105/3600}{(\pi/4)(0.1)^2} = 3.71 \frac{\text{m}}{\text{s}}, \quad \text{Re}_D = \frac{680(3.71)(0.1)}{2.92\text{E-}4} \approx 865000$$

From Fig. 6.41, which is reasonable for all orifice geometries, read  $C_d \approx 0.61$ . Then

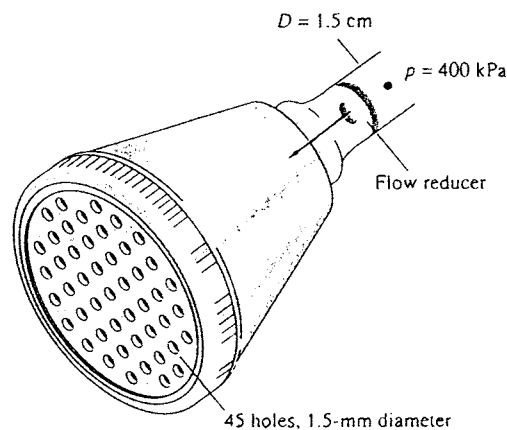
$$V_{\text{throat}} = \frac{3.71 \text{ m/s}}{\beta^2} = C_d \sqrt{\frac{2(55000)}{680(1-\beta^4)}}, \quad \text{or} \quad \frac{\beta^2}{(1-\beta^4)^{1/2}} \approx 0.478$$

Solve for  $\beta \approx \mathbf{0.66}$  Ans.

Checking back with Fig. 6.41, we see that this is about right, so no further iteration is needed for this level of accuracy.

**6.142** The shower head in Fig. P6.142 delivers water at 50°C. An orifice-type flow reducer is to be installed. The upstream pressure is constant at 400 kPa. What flow rate, in gal/min, results without the reducer? What reducer orifice diameter would decrease the flow by 40 percent?

**Solution:** For water at 50°C, take  $\rho = 988 \text{ kg/m}^3$  and  $\mu = 0.548\text{E-}3 \text{ kg/m}\cdot\text{s}$ . Further assume that the shower head is a *poor diffuser*, so the pressure in the head is



**Fig. P6.142**

also about 400 kPa. Assume the outside pressure is sea-level standard, 101 kPa. From Fig. 6.41 for a ‘typical’ orifice, estimate  $C_d \approx 0.61$ . Then, with  $\beta \approx 0$  for the small holes, each hole delivers a flow rate of

$$Q_{1 \text{ hole}} \approx C_d A_{\text{hole}} \sqrt{\frac{2\Delta p}{\rho(1-\beta^4)}} \approx 0.61 \left(\frac{\pi}{4}\right) (0.0015)^2 \sqrt{\frac{2(400000-101000)}{988(1-0^4)}},$$

or  $Q_{1 \text{ hole}} \approx 2.65\text{E-}5 \text{ m}^3/\text{s}$  and  $Q_{\text{total}} = 45Q_{1 \text{ hole}} \approx 0.00119 \frac{\text{m}^3}{\text{s}} \left(\approx 19 \frac{\text{gal}}{\text{min}}\right)$

This is a *large* flow rate—a lot of expensive hot water. Checking back, the inlet pipe for this flow rate has  $Re_D \approx 183000$ , so  $C_d \approx 0.60$  would be slightly better and a repeat of the calculation would give  $Q_{\text{no reducer}} \approx 0.00117 \text{ m}^3/\text{s} \approx \mathbf{18.6 \text{ gal/min}}$ . *Ans.*

A 40% reduction would give  $Q = 0.6(0.00117) = 7.04\text{E-}4 \text{ m}^3/\text{s} \div 45 = 1.57\text{E-}5 \text{ m}^3/\text{s}$  for each hole, which corresponds to a pressure drop

$$Q_{1 \text{ hole}} = 1.57\text{E-}5 = 0.60 \left(\frac{\pi}{4}\right) (0.0015)^2 \sqrt{\frac{2\Delta p}{988}}, \text{ or } \Delta p \approx 108000 \text{ Pa}$$

or  $p_{\text{inside head}} \approx 101 + 108 \approx 209 \text{ kPa}$ , the reducer must drop the inlet pressure to this.

$$Q = 7.04\text{E-}4 \approx 0.61 \left(\frac{\pi}{4}\right) (0.015\beta)^2 \left[\frac{2(400000-209000)}{988(1-\beta^4)}\right]^{1/2}, \text{ or } \frac{\beta^2}{(1-\beta^4)^{1/2}} \approx 0.332$$

Solve for  $\beta \approx 0.56$ ,  $d_{\text{reducer}} \approx 0.56(1.5) \approx \mathbf{0.84 \text{ cm}}$  *Ans.*

**6.143** A 10-cm-diameter smooth pipe contains an orifice plate with  $D: \frac{1}{2}D$  taps and  $\beta = 0.5$ . The measured orifice pressure drop is 75 kPa for water flow at 20°C. Estimate the flow rate, in  $\text{m}^3/\text{h}$ . What is the nonrecoverable head loss?

**Solution:** For water at 20°C, take  $\rho = 998 \text{ kg/m}^3$  and  $\mu = 0.001 \text{ kg/m}\cdot\text{s}$ . We know everything in the orifice relation, Eq. (6.104), except  $C_d$ , which we can estimate (as 0.61):

$$Q = C_d A_t \sqrt{\frac{2\Delta p}{\rho(1-\beta^4)}} = C_d \frac{\pi}{4} (0.05)^2 \sqrt{\frac{2(75000)}{998[1-(0.5)^4]}} = 0.0249 C_d$$

Guess  $C_d \approx 0.61$ ,  $Q \approx 0.0152 \frac{\text{m}^3}{\text{s}}$ ,  $Re_D = \frac{4\rho Q}{\pi\mu D} \approx 193000$ ,  $C_d$  (Eq. 6.112)  $\approx 0.605$

This is converged:  $Q = 0.0249(0.605) = 0.0150 \text{ m}^3/\text{s} \approx \mathbf{54 \text{ m}^3/\text{h}}$ . *Ans. (a)*

(b) From Fig. 6.44, the non-recoverable head loss coefficient is  $K \approx 1.8$ , based on  $V_t$ :

$$V_t = \frac{Q}{A_t} = \frac{0.0150}{\pi(0.025)^2} \approx 7.66 \frac{\text{m}}{\text{s}},$$

$$\Delta p_{\text{loss}} = K \frac{\rho}{2} V_t^2 = 1.8 \left( \frac{998}{2} \right) (7.66)^2 \approx \mathbf{53000 \text{ Pa}} \quad \text{Ans. (b)}$$

**6.144** Accurate solution of Prob. 6.143, using Fig. 6.41, requires iteration because both the ordinate and the abscissa of this figure contain the unknown flow rate  $Q$ . In the spirit of Example 5.8, rescale the variables and construct a new plot in which  $Q$  may be read directly from the ordinate. Solve Prob. 6.143 with your new chart.

**Solution:** Figure 6.41 has  $C_d$  versus  $\text{Re}_D$ , both of which contain  $Q$ :

$$C_d = \frac{Q}{A_t [2\Delta p / \rho(1 - \beta^4)]^{1/2}}; \quad \text{Re}_D = \frac{4\rho Q}{\pi\mu D}, \quad \text{then } \zeta = C_d^{-1} \text{Re}_D = \frac{\beta\rho d}{\mu} \left[ \frac{2\Delta p}{\rho(1 - \beta^4)} \right]^{1/2}$$

The quantity  $\zeta$  is independent of  $Q$ —sort of a  $Q$ -less Reynolds number. If we plot  $C_d$  versus  $\zeta$ , we should solve the problem of finding an unknown  $Q$  when  $\Delta p$  is known. The plot is shown below. For the data of Prob. 6.143, we compute

$$\left[ \frac{2\Delta p}{\rho(1 - \beta^4)} \right]^{1/2} = \left[ \frac{2(75000)}{998(1 - .5^4)} \right]^{1/2} = 12.7 \frac{\text{m}}{\text{s}}, \quad \zeta = \frac{0.5(998)(0.05)(12.7)}{0.001} \approx 316000$$

From the figure below, read  $C_d \approx \mathbf{0.605}$  (!) hence  $Q = C_d A_t [2\Delta p / \rho(1 - \beta^4)]^{1/2} = \mathbf{54 \text{ m}^3/\text{h}}$ .

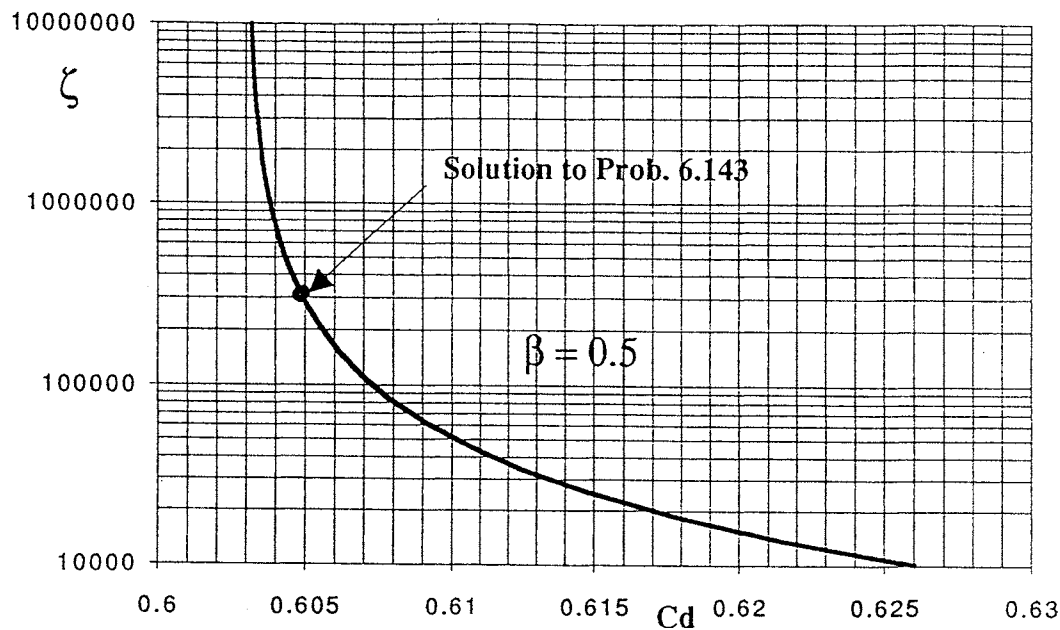


Fig. P6.144

**6.145** The 1-m-diameter tank in Fig. P6.145 is initially filled with gasoline at 20°C. There is a 2-cm-diameter orifice in the bottom. If the orifice is suddenly opened, estimate the time for the fluid level  $h(t)$  to drop from 2.0 to 1.6 meters.

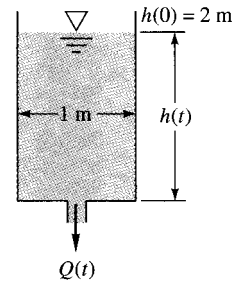


Fig. P6.145

**Solution:** For gasoline at 20°C, take  $\rho = 680 \text{ kg/m}^3$  and  $\mu = 2.92\text{E-}4 \text{ kg/m}\cdot\text{s}$ . The orifice simulates “corner taps” with  $\beta \approx 0$ , so, from Eq. (6.112),  $C_d \approx 0.596$ . From the energy equation, the pressure drop across the orifice is  $\Delta p = \rho gh(t)$ , or

$$Q = C_d A_t \sqrt{\frac{2\rho gh}{\rho(1-\beta^4)}} \approx 0.596 \left(\frac{\pi}{4}\right) (0.02)^2 \sqrt{2(9.81)h} \approx 0.000829\sqrt{h}$$

$$\text{But also } Q = -\frac{d}{dt}(v_{\text{tank}}) = -A_{\text{tank}} \frac{dh}{dt} = -\frac{\pi}{4} (1.0 \text{ m})^2 \frac{dh}{dt}$$

Set the  $Q$ 's equal, separate the variables, and integrate to find the draining time:

$$-\int_{2.0}^{1.6} \frac{dh}{\sqrt{h}} = 0.001056 \int_0^{t_{\text{final}}} dt, \quad \text{or } t_{\text{final}} = \frac{2[\sqrt{2} - \sqrt{1.6}]}{0.001056} = 283 \text{ s} \approx \mathbf{4.7 \text{ min}} \quad \text{Ans.}$$

**6.146** A pipe connecting two reservoirs, as in Fig. P6.146, contains a thin-plate orifice. For water flow at 20°C, estimate (a) the volume flow through the pipe and (b) the pressure drop across the orifice plate.

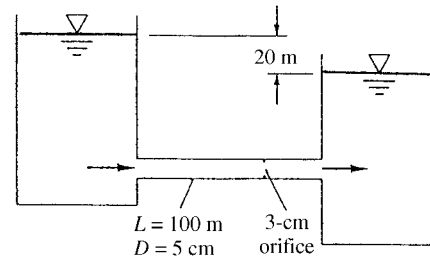


Fig. P6.146

**Solution:** For water at 20°C, take  $\rho = 998 \text{ kg/m}^3$  and  $\mu = 0.001 \text{ kg/m}\cdot\text{s}$ . The energy equation should include the orifice head loss and the entrance and exit losses:

$$\Delta z = 20 \text{ m} = \frac{V^2}{2g} \left( f \frac{L}{d} + \sum K \right), \quad \text{where } K_{\text{entr}} \approx 0.5, K_{\text{exit}} \approx 1.0, K_{\text{orifice}}^{\beta=0.6} \approx 1.5 \text{ (Fig. 6.44)}$$

$$V^2 = \frac{2(9.81)(20)}{[f(100/0.05) + 0.5 + 1.0 + 1.5]} = \frac{392.4}{2000f + 3.0}; \quad \text{guess } f \approx 0.02, V \approx 3.02 \text{ m/s}$$

$$\text{Iterate to } f_{\text{smooth}} \approx 0.0162, \quad V \approx 3.33 \text{ m/s}$$

The final  $\text{Re} = \rho V D / \mu \approx 166000$ , and  $Q = (\pi/4)(0.05)^2(3.33) \approx \mathbf{0.00653 \text{ m}^3/\text{s}}$  Ans. (a)

(b) The pressure drop across the orifice is given by the orifice formula:

$$\text{Re}_D = 166000, \quad \beta = 0.6, \quad C_d \approx 0.609 \text{ (Fig. 6.41):}$$

$$Q = 0.00653 = C_d A_t \left[ \frac{2\Delta p}{\rho(1-\beta^4)} \right]^{1/2} = 0.609 \left( \frac{\pi}{4} \right) (0.03)^2 \left[ \frac{2\Delta p}{998(1-0.6^4)} \right]^{1/2},$$

$$\Delta p = \mathbf{100 \text{ kPa}} \quad \text{Ans.}$$

**6.147** Air flows through a 6-cm-diameter smooth pipe which has a 2 m-long perforated section containing 500 holes (diameter 1 mm), as in Fig. P6.147. Pressure outside the pipe is sea-level standard air. If  $p_1 = 105 \text{ kPa}$  and  $Q_1 = 110 \text{ m}^3/\text{h}$ , estimate  $p_2$  and  $Q_2$ , assuming that the holes are approximated by thin-plate orifices. *Hint:* A momentum control volume may be very useful.

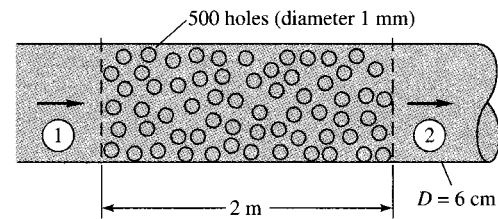


Fig. P6.147

**Solution:** For air at  $20^\circ\text{C}$  and  $105 \text{ kPa}$ , take  $\rho = 1.25 \text{ kg/m}^3$  and  $\mu = 1.8\text{E-}5 \text{ kg/m}\cdot\text{s}$ . Use the entrance flow rate to estimate the wall shear stress from the Moody chart:

$$V_1 = \frac{Q_1}{A} = \frac{110/3600}{(\pi/4)(0.06)^2} = 10.8 \frac{\text{m}}{\text{s}}, \quad \text{Re}_1 = \frac{1.25(10.8)(0.06)}{1.8\text{E-}5} \approx 45000, \quad f_{\text{smooth}} \approx 0.0214$$

$$\text{then } \tau_{\text{wall}} = \frac{f}{8} \rho V^2 = \frac{0.0214}{8} (1.25)(10.8)^2 \approx 0.390 \text{ Pa}$$

Further assume that the pressure does not change too much, so  $\Delta p_{\text{orifice}} \approx 105000 - 101350 \approx 3650 \text{ Pa}$ . Then the flow rate from the orifices is, approximately,

$$\beta \approx 0, \quad C_d \approx 0.61: \quad Q \approx 500 C_d A_t (2\Delta p/\rho)^{1/2} = 500(0.61) \left( \frac{\pi}{4} \right) (0.001)^2 \left[ \frac{2(3650)}{1.25} \right]^{1/2}$$

$$\text{or: } Q \approx \mathbf{0.0183 \text{ m}^3/\text{s}}, \quad \text{so } Q_2 = \frac{110}{3600} - 0.0183 \approx 0.01225 \text{ m}^3/\text{s}$$

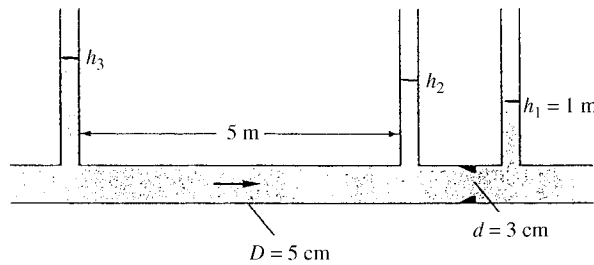
Then  $V_2 = Q_2/A_2 = 0.01225/[(\pi/4)(0.06)^2] \approx 4.33 \text{ m/s}$ . A control volume enclosing the pipe walls and sections (1) and (2) yields the x-momentum equation:

$$\sum F_x = p_1 A - p_2 A - \tau_w \pi D L = \dot{m}_2 V_2 - \dot{m}_1 V_1 = \rho A V_2^2 - \rho A V_1^2, \quad \text{divide by } A:$$

$$p_1 - p_2 = 0.390 \left[ \frac{\pi(0.06)(2.0)}{(\pi/4)(0.06)^2} \right] + 1.25(4.33)^2 - 1.25(10.8)^2 = 52 + 23 - 146 \approx -71 \text{ Pa}$$

Thus  $p_2 = 105000 + 71 \approx \mathbf{105 \text{ kPa}}$  also and above is correct:  $Q_2 = \mathbf{0.0123 \text{ m}^3/\text{s}}$ . *Ans.*

**6.148** A smooth pipe containing ethanol at  $20^\circ\text{C}$  flows at  $7 \text{ m}^3/\text{h}$  through a Bernoulli obstruction, as in Fig. P6.148. Three piezometer tubes are installed, as shown. If the obstruction is a thin-plate orifice, estimate the piezometer levels (a)  $h_2$  and (b)  $h_3$ .



**Fig. P6.148**

**Solution:** For ethanol at  $20^\circ\text{C}$ , take  $\rho = 789 \text{ kg/m}^3$  and  $\mu = 0.0012 \text{ kg/m}\cdot\text{s}$ . With the flow rate known, we can compute Reynolds number and friction factor, etc.:

$$V = \frac{Q}{A} = \frac{7/3600}{(\pi/4)(0.05)^2} = 0.99 \frac{\text{m}}{\text{s}}; \quad \text{Re}_D = \frac{789(0.99)(0.05)}{0.0012} = 32600, \quad f_{\text{smooth}} \approx 0.0230$$

From Fig. 6.44, at  $\beta = 0.6$ ,  $K \approx 1.5$ . Then the head loss across the orifice is

$$\Delta h = h_2 - h_1 = K \frac{V_t^2}{2g} = (1.5) \left[ \frac{\{0.99/(0.6)^2\}^2}{2(9.81)} \right] \approx 0.58 \text{ m}, \quad \text{hence } \mathbf{h_2 \approx 1.58 \text{ m}} \quad \textit{Ans. (a)}$$

Then the piezometer change between (2) and (3) is due to Moody friction loss:

$$h_3 - h_2 = h_f = f \frac{L}{d} \frac{V^2}{2g} = (0.023) \left( \frac{5}{0.05} \right) \frac{(0.99)^2}{2(9.81)} = 0.12 \text{ m},$$

$$\text{or } \mathbf{h_3 = 1.58 + 0.12 \approx 1.7 \text{ m}} \quad \textit{Ans. (b)}$$

**6.149** In a laboratory experiment, air at 20°C flows from a large tank through a 2-cm-diameter smooth pipe into a sea-level atmosphere, as in Fig. P6.149. The flow is metered by a long-radius nozzle of 1-cm diameter, using a manometer with Meriam red oil (SG = 0.827). The pipe is 8 m long. The measurements of tank pressure and manometer height are as follows:

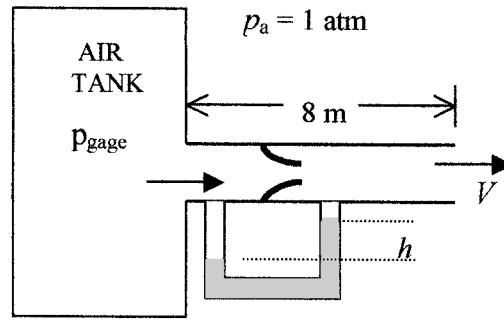


Fig. P6.149

$p_{\text{tank}}$ , Pa (gage):	60	320	1200	2050	2470	3500	4900
$h_{\text{mano}}$ , mm:	6	38	160	295	380	575	820

Use this data to calculate the flow rates  $Q$  and Reynolds numbers  $Re_D$  and make a plot of measured flow rate versus tank pressure. Is the flow laminar or turbulent? Compare the data with theoretical results obtained from the Moody chart, including minor losses. Discuss.

**Solution:** For air take  $\rho = 1.2 \text{ kg/m}^3$  and  $\mu = 0.000015 \text{ kg/m}\cdot\text{s}$ . With no elevation change and negligible tank velocity, the energy equation would yield

$$p_{\text{tank}} - p_{\text{atm}} = \frac{\rho V^2}{2} \left( 1 + f \frac{L}{D} + K_{\text{entrance}} + K_{\text{nozzle}} \right), \quad K_{\text{ent}} \approx 0.5 \text{ and } K_{\text{noz}} \approx 0.7$$

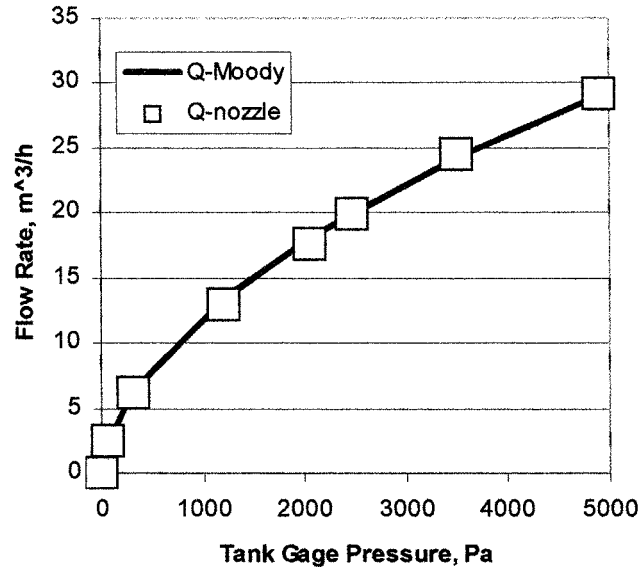
Since  $\Delta p$  is given, we can use this expression plus the Moody chart to predict  $V$  and  $Q = AV$  and compare with the flow-nozzle measurements. The flow nozzle formula is:

$$V_{\text{throat}} = C_d \sqrt{\frac{2\Delta p_{\text{mano}}}{\rho(1-\beta^4)}} \quad \text{where } \Delta p = (\rho_{\text{oil}} - \rho_{\text{air}})gh, \quad C_d \text{ from Fig. 6.42 and } \beta = 0.5$$

The friction factor is given by the smooth-pipe Moody formula, Eq. (6.48) for  $\varepsilon = 0$ . The results may be tabulated as follows, and the plot on the next page shows excellent (too good?) agreement with theory.

$p_{\text{tank}}$ , Pa:	60	320	1200	2050	2470	3500	4900
$V$ , m/s (nozzle data):	2.32	5.82	11.9	16.1	18.2	22.3	26.4
$Q$ , m <sup>3</sup> /h (nozzle data):	2.39	6.22	12.9	17.6	19.9	24.5	29.1
$Q$ , m <sup>3</sup> /h (theory):	2.31	6.25	13.3	18.0	20.0	24.2	28.9
$f_{\text{Moody}}$ :	0.0444	0.0331	0.0271	0.0252	0.0245	0.0234	0.0225





**6.150** Gasoline at 20°C flows at 0.06 m<sup>3</sup>/s through a 15-cm pipe and is metered by a 9-cm-diameter long-radius flow nozzle (Fig. 6.40a). What is the expected pressure drop across the nozzle?

**Solution:** For gasoline at 20°C, take  $\rho = 680$  kg/m and  $\mu = 2.92\text{E-}4$  kg/m·s. Calculate the pipe velocity and Reynolds number:

$$V = \frac{Q}{A} = \frac{0.06}{(\pi/4)(0.15)^2} = 3.40 \frac{\text{m}}{\text{s}}, \quad \text{Re}_D = \frac{680(3.40)(0.15)}{2.92\text{E-}4} \approx 1.19\text{E}6$$

The ISO correlation for discharge (Eq. 6.114) is used to estimate the pressure drop:

$$C_d \approx 0.9965 - 0.00653 \left( \frac{10^6 \beta}{\text{Re}_D} \right)^{1/2} = 0.9965 - 0.00653 \left[ \frac{10^6(0.6)}{1.19\text{E}6} \right]^{1/2} \approx 0.9919$$

$$\text{Then } Q = 0.06 = (0.9919) \left( \frac{\pi}{4} \right) (0.09)^2 \sqrt{\frac{2 \Delta p}{680(1 - 0.6^4)}}$$

Solve  $\Delta p \approx 27000$  Pa *Ans.*

**6.151** Ethyl alcohol at 20°C, flowing in a 6-cm-diameter pipe, is metered through a 3-cm-diameter long-radius flow nozzle. If the measured pressure drop is 45 kPa, what is the estimated flow rate in m<sup>3</sup>/h?

**Solution:** For ethanol at 20°C, take  $\rho = 789 \text{ kg/m}^3$  and  $\mu = 0.0012 \text{ kg/m}\cdot\text{s}$ . Not knowing  $Re$ , we estimate  $C_d \approx 0.99$  and make a first calculation for  $Q$ :

$$\text{If } C_d \approx 0.99, \text{ then } Q \approx 0.99 \left( \frac{\pi}{4} \right) (0.03)^2 \sqrt{\frac{2(45000)}{789(1-0.5^4)}} \approx 0.00772 \text{ m}^3/\text{s}$$

$$\text{Compute } Re_D = \frac{4(789)(0.00772)}{\pi(0.0012)(0.06)} \approx 108000, \text{ compute } C_d \approx 0.9824 \text{ from Eq. 6.114}$$

Therefore a slightly better estimate of flow rate is  $Q \approx 0.0766 \text{ m}^3/\text{s}$ . *Ans.*

---

**6.152** Kerosene at 20°C flows at 20 m<sup>3</sup>/h in an 8-cm-diameter pipe. The flow is to be metered by an ISA 1932 flow nozzle so that the pressure drop is 7 kPa. What is the proper nozzle diameter?

**Solution:** For kerosene at 20°C, take  $\rho = 804 \text{ kg/m}^3$  and  $\mu = 1.92\text{E-}3 \text{ kg/m}\cdot\text{s}$ . We cannot calculate the discharge coefficient exactly because we don't know  $\beta$ , so just estimate  $C_d$ :

$$\text{Guess } C_d \approx 0.99, \text{ then } Q \approx 0.99 \left( \frac{\pi}{4} \right) (0.08\beta)^2 \sqrt{\frac{2(7000)}{804(1-\beta^4)}} = \frac{20 \text{ m}^3}{3600 \text{ s}}$$

$$\text{or: } \frac{\beta^2}{(1-\beta^4)^{1/2}} \approx 0.268, \text{ solve } \beta \approx 0.508,$$

$$Re_D = \frac{4(804)(20/3600)}{\pi(1.92\text{E-}3)(0.08)} \approx 37000$$

Now compute a better  $C_d$  from the ISA nozzle correlation, Eq. (6.115):

$$C_d \approx 0.99 - 0.2262\beta^{4.1} + (0.000215 - 0.001125\beta + 0.00249\beta^{4.7}) \left( \frac{10^6}{Re_D} \right)^{1.15} \approx 0.9647$$

Iterate once to obtain a better  $\beta \approx 0.515$ ,  $d = 0.515(8 \text{ cm}) \approx 4.12 \text{ cm}$  *Ans.*

---

**6.153** Two water tanks, each with base area of  $1 \text{ ft}^2$ , are connected by a 0.5-in-diameter long-radius nozzle as in Fig. P6.153. If  $h = 1 \text{ ft}$  as shown for  $t = 0$ , estimate the time for  $h(t)$  to drop to 0.25 ft.

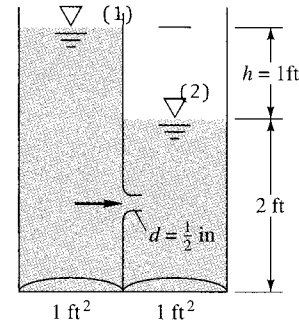


Fig. P6.153

**Solution:** For water at  $20^\circ\text{C}$ , take  $\rho = 1.94 \text{ slug/ft}^3$  and  $\mu = 2.09\text{E-}5 \text{ slug/ft}\cdot\text{s}$ . For a long-radius nozzle with  $\beta \approx 0$ , guess  $C_d \approx 0.98$  and  $K_{\text{loss}} \approx 0.9$  from Fig. 6.44. The elevation difference  $h$  must balance the head losses in the nozzle and submerged exit:

$$\Delta z = \sum h_{\text{loss}} = \frac{V_t^2}{2g} \sum K = \frac{V_t^2}{2(32.2)} (0.9_{\text{nozzle}} + 1.0_{\text{exit}}) = h, \quad \text{solve } V_t = 5.82\sqrt{h}$$

$$\text{hence } Q = V_t \left( \frac{\pi}{4} \right) \left( \frac{1/2}{12} \right)^2 \approx 0.00794\sqrt{h} = -\frac{1}{2} A_{\text{tank}} \frac{dh}{dt} = -0.5 \frac{dh}{dt}$$

The boldface factor  $1/2$  accounts for the fact that, as the left tank falls by  $dh$ , the right tank rises by the same amount, hence  $dh/dt$  changes twice as fast as for one tank alone. We can separate and integrate and find the time for  $h$  to drop from 1 ft to 0.25 ft:

$$\int_{0.25}^{1.0} \frac{dh}{\sqrt{h}} = 0.0159 \int_0^{t_{\text{final}}} dt, \quad \text{or: } t_{\text{final}} = \frac{2(\sqrt{1} - \sqrt{0.25})}{0.0159} \approx \mathbf{63 \text{ s}} \quad \text{Ans.}$$

**6.154** Water at  $20^\circ\text{C}$  flows through the orifice in the figure, which is monitored by a mercury manometer. If  $d = 3 \text{ cm}$ , (a) what is  $h$  when the flow is  $20 \text{ m}^3/\text{h}$ ; and (b) what is  $Q$  when  $h = 58 \text{ cm}$ ?

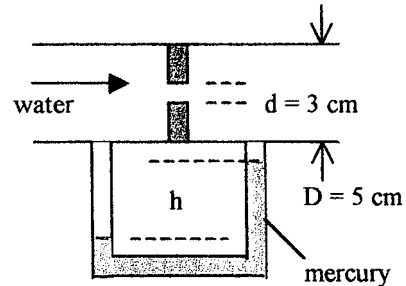


Fig. P6.154

**Solution:** (a) Evaluate  $V = Q/A = 2.83 \text{ m/s}$  and  $\text{Re}_D = \rho V D / \mu = 141,000$ ,  $\beta = 0.6$ , thus  $C_d \approx 0.613$ .

$$Q = \frac{20}{3600} = C_d \frac{\pi}{4} d^2 \sqrt{\frac{2\Delta p}{\rho(1-\beta^4)}} = (0.613) \frac{\pi}{4} (0.03)^2 \sqrt{\frac{2(13550 - 998)(9.81)h}{998(1-0.6^4)}}$$

where we have introduced the manometer formula  $\Delta p = (\rho_{\text{mercury}} - \rho_{\text{water}})gh$ .

Solve for:  $h \approx 0.58 \text{ m} = \mathbf{58 \text{ cm}}$  Ans. (a)

Solve this problem when  $h = 58$  cm is known and  $Q$  is the unknown. Well, we can see that the numbers are the same as part (a), and the solution is

$$\text{Solve for: } Q \approx 0.00556 \text{ m}^3/\text{s} = \mathbf{20 \text{ m}^3/\text{h}} \quad \text{Ans. (b)}$$

**6.155** It is desired to meter a flow of  $20^\circ\text{C}$  gasoline in a 12-cm-diameter pipe, using a modern venturi nozzle. In order for international standards to be valid (Fig. 6.40), what is the permissible range of (a) flow rates, (b) nozzle diameters, and (c) pressure drops? (d) For the highest pressure-drop condition, would compressibility be a problem?

**Solution:** For gasoline at  $20^\circ\text{C}$ , take  $\rho = 680 \text{ kg/m}^3$  and  $\mu = 2.92\text{E-}4 \text{ kg/m}\cdot\text{s}$ . Examine the possible range of Reynolds number and beta ratio:

$$1.5\text{E}5 < \text{Re}_D = \frac{4\rho Q}{\pi\mu D} = \frac{4(680)Q}{\pi(2.92\text{E-}4)(0.12)} < 2.0\text{E}5,$$

$$\text{or } \mathbf{0.0061 < Q < 0.0081 \frac{\text{m}^3}{\text{s}}} \quad \text{Ans. (a)}$$

$$0.316 < \beta = d/D < 0.775, \quad \text{or: } \mathbf{3.8 < d < 9.3 \text{ cm}} \quad \text{Ans. (b)}$$

For estimating pressure drop, first compute  $C_d(\beta)$  from Eq. (6.116):  $0.924 < C_d < 0.985$ :

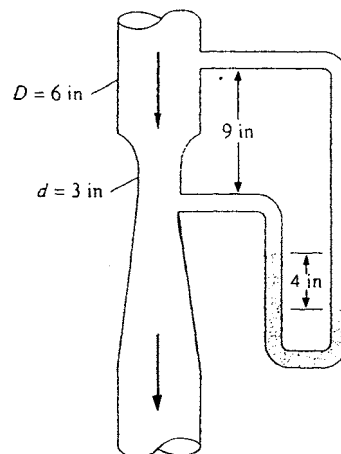
$$Q = C_d \frac{\pi}{4} (0.12\beta)^2 \sqrt{\frac{2\Delta p}{680(1-\beta^4)}}, \quad \text{or: } \Delta p = 2.66\text{E}6(1-\beta^4) \left[ \frac{Q}{C_d\beta^2} \right]^2$$

put in large  $Q$ , small  $\beta$ , etc. to obtain the range  $\mathbf{200 < \Delta p < 18000 \text{ Pa}}$  Ans. (c)

**6.156** Ethanol at  $20^\circ\text{C}$  flows down through a modern venturi nozzle as in Fig. P6.156. If the mercury manometer reading is 4 in, as shown, estimate the flow rate, in gal/min.

**Solution:** For ethanol at  $20^\circ\text{C}$ , take  $\rho = 1.53 \text{ slug/ft}^3$  and  $\mu = 2.51\text{E-}5 \text{ slug/ft}\cdot\text{s}$ . Given  $\beta = 0.5$ , the discharge coefficient is

$$C_d = 0.9858 - 0.196(0.5)^{4.5} \approx 0.9771$$



**Fig. P6.156**

The 9-inch displacement of manometer taps does not affect the pressure drop reading, because both legs are filled with ethanol. Therefore we proceed directly to  $\Delta p$  and  $Q$ :

$$\Delta p_{\text{nozzle}} = (\rho_{\text{merc}} - \rho_{\text{eth}})gh = (26.3 - 1.53)(32.2)(4/12) \approx 266 \text{ lbf/ft}^2$$

$$\text{Hence } Q = C_d A_t \left[ \frac{2 \Delta p}{\rho(1 - \beta^4)} \right]^{1/2} = 0.9771 \left( \frac{\pi}{4} \right) \left( \frac{3}{12} \right)^2 \sqrt{\frac{2(266)}{1.53(1 - 0.5^4)}} \approx \mathbf{0.924 \frac{\text{ft}^2}{\text{s}}} \quad \text{Ans.}$$

**6.157** Modify Prob. 6.156 if the fluid is *air* at 20°C, entering the venturi at a pressure of 18 psia. Should a compressibility correction be used?

**Solution:** For air at 20°C and 18 psi, take  $\rho = 0.00286 \text{ slug/ft}^3$  and  $\mu = 3.76\text{E-}7 \text{ slug/ft}\cdot\text{s}$ . With  $\beta$  still equal to 0.5,  $C_d$  still equals 0.9771 as previous page. The manometer reading is

$$\Delta p_{\text{nozzle}} = (26.3 - 0.00286)(32.2)(4/12) \approx 282 \text{ lbf/ft}^2,$$

$$\text{whence } Q = 0.9771 \left( \frac{\pi}{4} \right) \left( \frac{3}{12} \right)^2 \sqrt{\frac{2(282)}{0.00286(1 - 0.5^4)}} \approx \mathbf{22.0 \frac{\text{ft}^3}{\text{s}}} \quad \text{Ans.}$$

From this result, the throat velocity  $V_t = Q/A_t \approx 448 \text{ ft/s}$ , quite high, the Mach number in the throat is approximately  $Ma = 0.4$ , a **(slight) compressibility correction might be expected**. [Making a one-dimensional subsonic-flow correction, using the methods of Chap. 9, results in a throat volume flow estimate of  $Q \approx 22.8 \text{ ft}^3/\text{s}$ , about 4% higher.]

**6.158** Water at 20°C flows in a long horizontal commercial-steel 6-cm-diameter pipe which contains a classical Herschel venturi with a 4-cm throat. The venturi is connected to a mercury manometer whose reading is  $h = 40 \text{ cm}$ . Estimate (a) the flow rate, in  $\text{m}^3/\text{h}$ , and (b) the total pressure difference between points 50 cm upstream and 50 cm downstream of the venturi.

**Solution:** For water at 20°C, take  $\rho = 998 \text{ kg/m}^3$  and  $\mu = 0.001 \text{ kg/m}\cdot\text{s}$ . For commercial steel,  $\varepsilon \approx 0.046 \text{ mm}$ , hence  $\varepsilon/d = 0.046/60 = 0.000767$ . First *estimate* the flow rate:

$$\Delta p = (\rho_m - \rho_w)gh = (13560 - 998)(9.81)(0.40) \approx 49293 \text{ Pa}$$

$$\text{Guess } C_d \approx 0.985, \quad Q = (0.985) \left( \frac{\pi}{4} \right) (0.04)^2 \sqrt{\frac{2(49293)}{998[1 - (4/6)^4]}} \approx 0.0137 \frac{\text{m}^3}{\text{s}}$$

$$\text{Check } Re_D = \frac{4\rho Q}{\pi\mu D} \approx 291000$$

At this Reynolds number, we see from Fig. 6.42 that  $C_d$  does indeed  $\approx 0.985$  for the Herschel venturi. Therefore, indeed,  $Q = 0.0137 \text{ m}^3/\text{s} \approx 49 \text{ m}^3/\text{h}$ . *Ans. (a)*

(b) 50 cm upstream and 50 cm downstream are far enough that the pressure recovers from its throat value, and the total  $\Delta p$  is the sum of Moody pipe loss and venturi head loss. First work out the pipe velocity,  $V = Q/A = (0.0137)/[(\pi/4)(0.06)^2] \approx 4.85 \text{ m/s}$ . Then

$$\text{Re}_D = 291000, \quad \frac{\varepsilon}{d} = 0.000767, \quad \text{then } f_{\text{Moody}} \approx 0.0196; \quad \text{Fig. 6.44: } K_{\text{venturi}} \approx 0.2$$

$$\begin{aligned} \text{Then } \Delta p &= \Delta p_{\text{Moody}} + \Delta p_{\text{venturi}} = \frac{\rho V^2}{2} \left( f \frac{L}{d} + K \right) \\ &= \frac{998(4.85)^2}{2} \left[ 0.0196 \left( \frac{1.0}{0.06} \right) + 0.2 \right] \approx \mathbf{6200 \text{ Pa}} \quad \text{Ans. (b)} \end{aligned}$$

**6.159** A modern venturi nozzle is tested in a laboratory flow with water at  $20^\circ\text{C}$ . The pipe diameter is 5.5 cm, and the venturi throat diameter is 3.5 cm. The flow rate is measured by a weigh tank and the pressure drop by a water-mercury manometer. The mass flow rate and manometer readings are as follows:

$\dot{m}, \text{kg/s:}$	0.95	1.98	2.99	5.06	8.15
$h, \text{mm:}$	3.7	15.9	36.2	102.4	264.4

Use these data to plot a calibration curve of venturi discharge coefficient versus Reynolds number. Compare with the accepted correlation, Eq. (6.116).

**Solution:** For water at  $20^\circ\text{C}$ , take  $\rho = 998 \text{ kg/m}^3$  and  $\mu = 0.001 \text{ kg/m}\cdot\text{s}$ . The given data of mass flow and manometer height can readily be converted to discharge coefficient and Reynolds number:

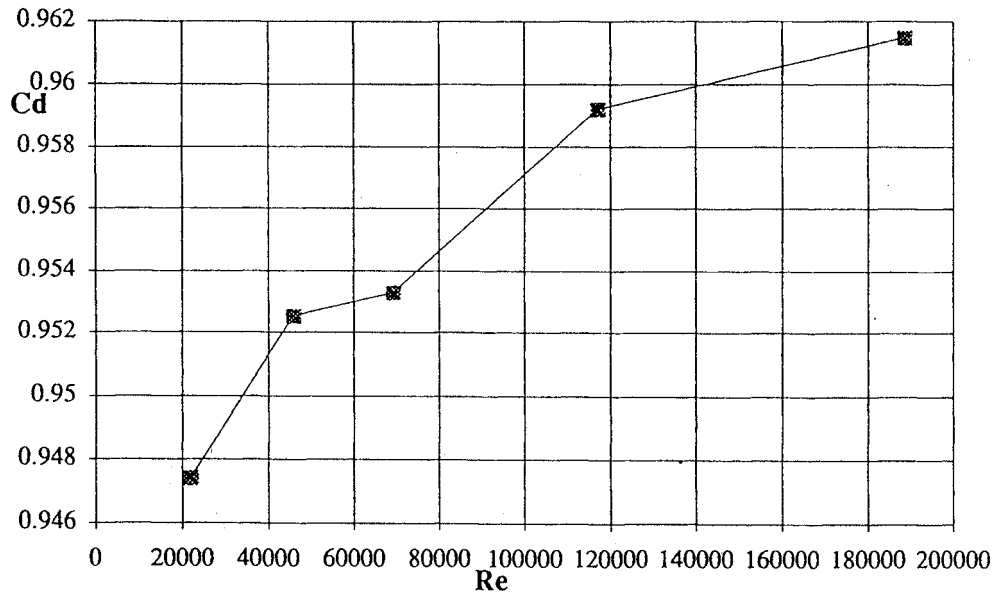
$$Q = \frac{\dot{m}}{998} = C_d \left( \frac{\pi}{4} \right) (0.035)^2 \sqrt{\frac{2(13.56-1)\rho_w(9.81)h}{\rho_w[1-(3.5/5.5)^4]}}, \quad \text{or: } C_d \approx \frac{\dot{m} \text{ (kg/s)}}{16.485 \sqrt{h_{\text{meters}}}}$$

$$\text{Re}_D = \frac{4 \dot{m}}{\pi \mu D} = \frac{4 \dot{m}}{\pi(0.001)(0.055)} \approx 23150 \dot{m} \text{ (kg/s)}$$

The data can then be converted and tabulated as follows:

$h, \text{m:}$	0.037	0.0159	0.0362	0.1024	0.2644
$C_d:$	0.947	0.953	0.953	0.959	0.962
$\text{Re}_D:$	22000	46000	69000	117000	189000

These data are plotted in the graph below, similar to Fig. 6.42 of the text:



They closely resemble the “classical Herschel venturi,” but this data is actually for a *modern* venturi, for which we only know the value of  $C_d$  for  $1.5E5 < Re_D \leq 2E5$ :

$$\text{Eq. (6.116)} \quad C_d \approx 0.9858 - 0.196 \left( \frac{3.5}{5.5} \right)^{4.5} \approx \mathbf{0.960}$$

The two data points near this Reynolds number range are quite close to  $0.960 \pm 0.002$ .

**6.160** The butterfly-valve losses in Fig. 6.19*b* may be viewed as a type of Bernoulli obstruction device, as in Fig. 6.39. The “throat area”  $A_t$  in Eq. (6.104) can be interpreted as the two slivers of opening around the butterfly disk when viewed from upstream. First fit the average loss  $K_{\text{mean}}$  versus the opening angle in Fig. 6.19*b* to an exponential curve. Then use your curve fit to compute the “discharge coefficient” of a butterfly valve as a function of the opening angle. Plot the results and compare them to those for a typical flow-meter.

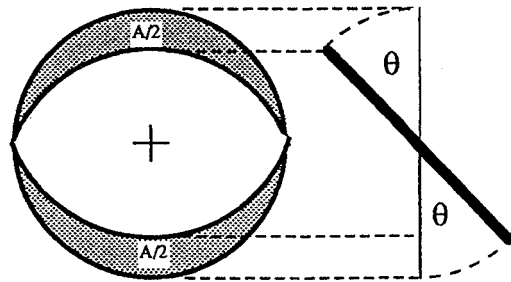


Fig. P6.160

**Solution:** The two “slivers” referred to are shown. The total sliver area equals *total* area reduced by a cosine factor:

$$A_{\text{sliver}} = A_{\text{total}}(1 - \cos\theta), \quad \text{where } A_{\text{total}} = \pi R^2, \quad R = \text{valve and pipe radius}$$

The “effective” velocity passing through the slivers may be computed from continuity:

$$V_{\text{eff}} = \frac{Q}{A_{\text{slivers}}} = \frac{Q}{A_{\text{total}}} \frac{A_{\text{total}}}{A_{\text{slivers}}} = \frac{V_{\text{pipe}}}{A_s/A_t} = \frac{V_{\text{pipe}}}{(1 - \cos\theta)}$$

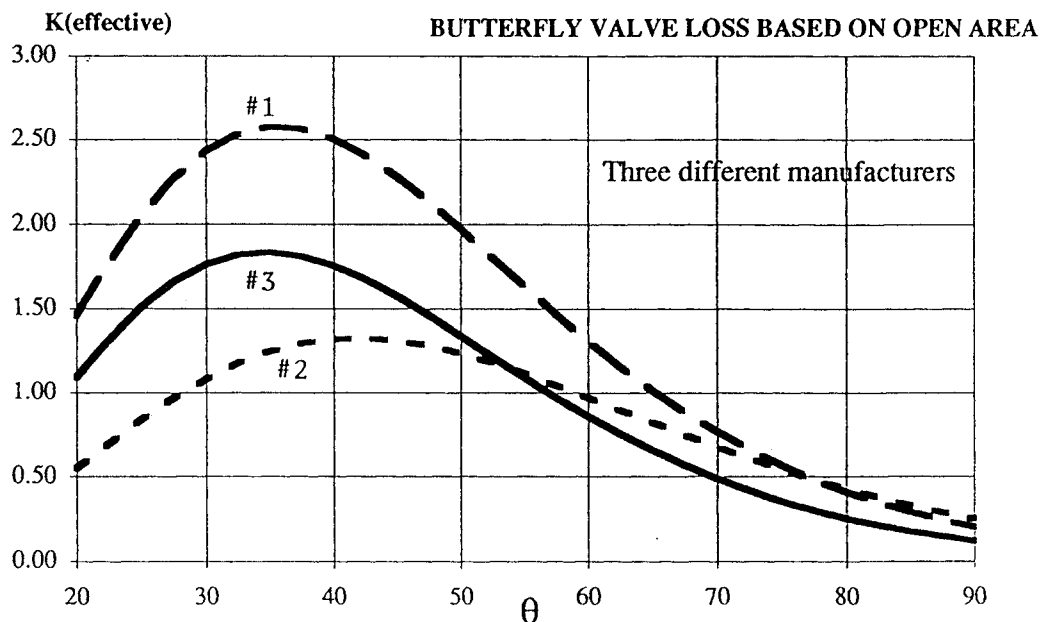
Then the problem suggests that the loss coefficients might correlate better (and not vary so much or be so large as in Fig. 6.19b) if the loss is based on effective velocity:

$$K_{\text{better}} = \frac{h_{\text{loss}}}{V_{\text{eff}}^2/2g} = \frac{h_{\text{loss}}}{V_{\text{pipe}}^2/2g} \left( \frac{V_{\text{pipe}}}{V_{\text{eff}}} \right)^2 = K_{\text{Fig.6.19}}(1 - \cos\theta)^2$$

So we take the data for traditional “K” in Fig. 6.19b, multiply it by  $(1 - \cos\theta)^2$ , and replot it below. Actually, we have taken three exponential curve-fits, one for each manufacturer’s data shown in Fig. 6.19, to give an idea of the data uncertainty:

$$\#1: K_1 \approx 3500 e^{-0.109\theta}; \quad \#2: K_2 \approx 930 e^{-0.091\theta}; \quad \#3: K_3 \approx 2800 e^{-0.112\theta}, \quad \theta \text{ in degrees}$$

The calculations are made and are shown plotted below. This idea works fairly well, but the K’s still vary a bit over the range of  $\theta$ . However, all K’s are now of order unity, which is a better correlation than the huge variations shown in Fig. 6.19b.





**6.161** Air flows at high speed through a Herschel venturi monitored by a mercury manometer, as shown in Fig. P6.161. The upstream conditions are 150 kPa and 80°C. If  $h = 37$  cm, estimate the mass flow in kg/s. [HINT: The flow is compressible.]

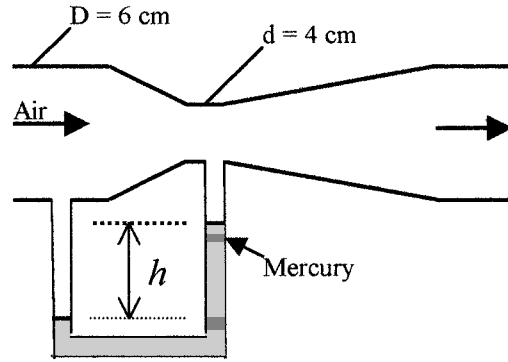


Fig. P6.161

**Solution:** The upstream density is  $\rho_1 = p_1/(RT) = (150000)/[287(273 + 80)] = 1.48$  kg/m<sup>3</sup>. The clue “high speed” means that we had better use the *compressible* venturi formula, Eq. (6.117):

$$\dot{m} = C_d Y A_t \sqrt{\frac{2\rho_1(p_1 - p_2)}{1 - \beta^4}} \quad \text{where } \beta = 4/6 \text{ for this nozzle.}$$

The pressure difference is measured by the mercury manometer:

$$p_1 - p_2 = (\rho_{\text{merc}} - \rho_{\text{air}})gh = (13550 - 1.48 \text{ kg/m}^3)(9.81 \text{ m/s}^2)(0.37 \text{ m}) = 49200 \text{ Pa}$$

The pressure ratio is thus  $(150 - 49.2)/150 = 0.67$  and, for  $\beta = 2/3$ , we read  $Y \approx 0.76$  from Fig. 6.45. From Fig. 6.43 estimate  $C_d \approx 0.985$ . The (compressible) venturi formula thus predicts:

$$\dot{m} = 0.985(0.76) \left[ \frac{\pi}{4} (0.04 \text{ m})^2 \right] \sqrt{\frac{2(1.48)(49200)}{1 - (2/3)^4}} = \mathbf{0.40 \frac{\text{kg}}{\text{s}}} \quad \text{Ans.}$$

**6.162** Modify Prob. 6.161 as follows. Find the manometer reading  $h$  for which the mass flow through the venturi is approximately 0.4 kg/s. [HINT: The flow is compressible.]

**Solution:** This is, in fact, the answer to Prob. 6.161, but who knew? The present problem is intended as an iteration exercise, preferably with EES. We know the upstream pressure and density and the discharge coefficient, but we must iterate for  $Y$  and  $p_2$  in the basic formula:

$$\dot{m} = C_d Y A_t \sqrt{\frac{2\rho_1(p_1 - p_2)}{1 - \beta^4}} = 0.40 \text{ kg/s}$$

The answer should be  $h = 0.37$  m, as in Prob. 6.161, but the problem is extremely sensitive to the value of  $h$ . A 10% change in  $h$  causes only a 2% change in mass flow. The actual answer to Prob. 6.161 was a mass flow of 0.402 kg/s. EES reports that, for mass flow *exactly* equal to 0.400 kg/s, the required manometer height is  $h = \mathbf{0.361 \text{ m}}$ . Ans.

**FUNDAMENTALS OF ENGINEERING EXAM PROBLEMS: Answers**

FE 6.1 In flow through a straight, smooth pipe, the diameter Reynolds number for transition to turbulence is generally taken to be

- (a) 1500 (b) **2300** (c) 4000 (d) 250,000 (e) 500,000

FE 6.2 For flow of water at 20°C through a straight, smooth pipe at 0.06 m<sup>3</sup>/h, the pipe diameter for which transition to turbulence occurs is approximately

- (a) **1.0 cm** (b) 1.5 cm (c) 2.0 cm (d) 2.5 cm (e) 3.0 cm

FE 6.3 For flow of oil ( $\mu = 0.1$  kg/(m·s), SG = 0.9) through a long, straight, smooth 5-cm-diameter pipe at 14 m<sup>3</sup>/h, the pressure drop per meter is approximately

- (a) 2200 Pa (b) **2500 Pa** (c) 10,000 Pa (d) 160 Pa (e) 2800 Pa

FE 6.4 For flow of water at a Reynolds number of 1.03E6 through a 5-cm-diameter pipe of roughness height 0.5 mm, the approximate Moody friction factor is

- (a) 0.012 (b) 0.018 (c) **0.038** (d) 0.049 (e) 0.102

FE 6.5 Minor losses through valves, fittings, bends, contractions etc. are commonly modeled as proportional to

- (a) total head (b) static head (c) **velocity head** (d) pressure drop (e) velocity

FE 6.6 A smooth 8-cm-diameter pipe, 200 m long, connects two reservoirs, containing water at 20°C, one of which has a surface elevation of 700 m and the other with its surface elevation at 560 m. If minor losses are neglected, the expected flow rate through the pipe is

- (a) 0.048 m<sup>3</sup>/h (b) 2.87 m<sup>3</sup>/h (c) 134 m<sup>3</sup>/h (d) **172 m<sup>3</sup>/h** (e) 385 m<sup>3</sup>/h

FE 6.7 If, in Prob. FE 6.6 the pipe is rough and the actual flow rate is 90 m<sup>3</sup>/hr, then the expected average roughness height of the pipe is approximately

- (a) 1.0 mm (b) **1.25 mm** (c) 1.5 mm (d) 1.75 mm (e) 2.0 mm

FE 6.8 Suppose in Prob. FE 6.6 the two reservoirs are connected, not by a pipe, but by a sharp-edged orifice of diameter 8 cm. Then the expected flow rate is approximately

- (a) 90 m<sup>3</sup>/h (b) **579 m<sup>3</sup>/h** (c) 748 m<sup>3</sup>/h (d) 949 m<sup>3</sup>/h (e) 1048 m<sup>3</sup>/h

FE 6.9 Oil ( $\mu = 0.1$  kg/(m·s), SG = 0.9) flows through a 50-m-long smooth 8-cm-diameter pipe. The maximum pressure drop for which laminar flow is expected is approximately

- (a) 30 kPa (b) 40 kPa (c) 50 kPa (d) 60 kPa (e) **70 kPa**

FE 6.10 Air at 20°C and approximately 1 atm flows through a smooth 30-cm-square duct at 1500 cubic feet per minute. The expected pressure drop per meter of duct length is

- (a) 1.0 Pa (b) **2.0 Pa** (c) 3.0 Pa (d) 4.0 Pa (e) 5.0 Pa

FE 6.11 Water at 20°C flows at 3 cubic meters per hour through a sharp-edged 3-cm-diameter orifice in a 6-cm-diameter pipe. Estimate the expected pressure drop across the orifice.

- (a) 440 Pa (b) 680 Pa (c) 875 Pa (d) **1750 Pa** (e) 1870 Pa

FE 6.12 Water flows through a straight 10-cm-diameter pipe at a diameter Reynolds number of 250,000. If the pipe roughness is 0.06 mm, what is the approximate Moody friction factor?

- (a) 0.015 (b) 0.017 (c) **0.019** (d) 0.026 (e) 0.032

FE 6.13 What is the hydraulic diameter of a rectangular air-ventilation duct whose cross-section is 1 meter by 25 cm?

- (a) 25 cm (b) **40 cm** (c) 50 cm (d) 75 cm (e) 100 cm

FE 6.14 Water at 20°C flows through a pipe at 300 gal/min with a friction head loss of 45 ft. What is the power required to drive this flow?

- (a) 0.16 kW (b) 1.88 kW (c) **2.54 kW** (d) 3.41 kW (e) 4.24 kW

FE 6.15 Water at 20°C flows at 200 gal/min through a pipe 150 m long and 8 cm in diameter. If the friction head loss is 12 m, what is the Moody friction factor?

- (a) 0.010 (b) 0.015 (c) **0.020** (d) 0.025 (e) 0.030

## COMPREHENSIVE PROBLEMS

**C6.1** A pitot-static probe will be used to measure the velocity distribution in a water tunnel at 20°C. The two pressure lines from the probe will be connected to a U-tube manometer which uses a liquid of specific gravity 1.7. The maximum velocity expected in the water tunnel is 2.3 m/s. Your job is to select an appropriate U-tube from a manufacturer which supplies manometers of heights 8, 12, 16, 24 and 36 inches. The cost increases significantly with manometer height. Which of these should you purchase?

**Solution:** The pitot-static tube formula relates velocity to the difference between stagnation pressure  $p_o$  and static pressure  $p_s$  in the water flow:

$$p_o - p_s = \frac{1}{2} \rho_w V^2, \quad \text{where } \rho_w = 998 \frac{\text{kg}}{\text{m}^3} \quad \text{and} \quad V_{max} = 2.3 \frac{\text{m}}{\text{s}}$$

Meanwhile, the manometer reading  $h$  relates this pressure difference to the two fluids:

$$p_o - p_s = (\rho_{mano} - \rho_w)gh = \rho_w (SG_{mano} - 1)gh$$

$$\text{Solve for } h_{max} = \frac{V_{max}^2}{2g(SG_{mano} - 1)} = \frac{(2.3)^2}{2(9.81)(1.7 - 1)} = 0.385 \text{ m} = \mathbf{15.2 \text{ in}}$$

It would therefore be most economical to **buy the 16-inch manometer**. But be careful when you use it: a bit of overpressure will pop the manometer fluid out of the tube!

**C6.2** A pump delivers a steady flow of water ( $\rho, \mu$ ) from a large tank to two other higher-elevation tanks, as shown. The same pipe of diameter  $d$  and roughness  $\varepsilon$  is used throughout. All minor losses *except through the valve* are neglected, and the partially-closed valve has a loss coefficient  $K_{valve}$ . Turbulent flow may be assumed with all kinetic energy flux correction coefficients equal to 1.06. The pump net head  $H$  is a known function of  $Q_A$  and hence also of  $V_A = Q_A/A_{pipe}$ , for example,  $H = a - bV_A^2$ , where  $a$  and  $b$  are constants. Subscript J refers to the junction point at the tee where branch A splits into B and C. Pipe length  $L_C$  is much longer than  $L_B$ . It is desired to predict the pressure at J, the three pipe velocities and friction factors, and the pump head. Thus there are 8 variables:  $H, V_A, V_B, V_C, f_A, f_B, f_C, p_J$ . Write down the eight equations needed to resolve this problem, but *do not solve*, since an elaborate iteration procedure, or an equation solver such as EES, would be required.

**Solution:** First, equation (1) is clearly the pump performance:

$$H = a - bV_A^2 \tag{1}$$

$$3 \text{ Moody factors: } f_A = fcn\left(V_A, \frac{\varepsilon}{d}\right) \quad (2)$$

$$f_B = fcn\left(V_B, \frac{\varepsilon}{d}\right) \quad (3)$$

$$f_C = fcn\left(V_C, \frac{\varepsilon}{d}\right) \quad (4)$$

$$\text{Conservation of mass (constant area) at the junction J: } V_A = V_B + V_C \quad (5)$$

Finally, there are three independent steady-flow energy equations:

$$(1) \text{ to } (2): \quad z_1 = z_2 - H + f_A \frac{L_A}{d} \frac{V_A^2}{2g} + f_B \frac{L_B}{d} \frac{V_B^2}{2g} \quad (6)$$

$$(1) \text{ to } (3): \quad z_1 = z_3 - H + f_A \frac{L_A}{d} \frac{V_A^2}{2g} + f_C \frac{L_C}{d} \frac{V_C^2}{2g} + K_{\text{valve}} \frac{V_C^2}{2g} \quad (7)$$

$$(J) \text{ to } (2): \quad \frac{p_J}{\rho g} + z_J = \frac{p_{\text{atm}}}{\rho g} + z_2 + f_B \frac{L_B}{d} \frac{V_B^2}{2g} \quad (8)$$

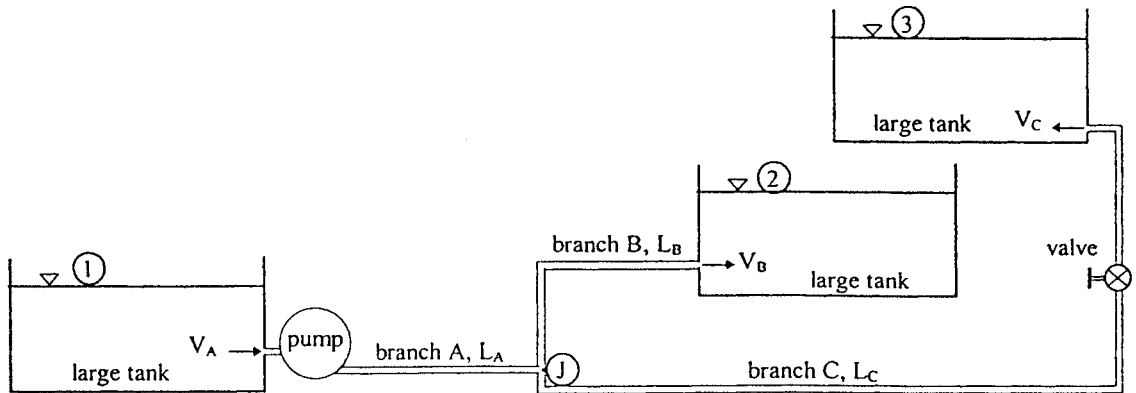


Fig. PC6.2

**C6.3** The water slide in the figure is to be installed in a swimming pool. The manufacturer recommends a continuous water flow of  $1.39\text{E-}3 \text{ m}^3/\text{s}$  (about 22 gal/min) down the slide to ensure that customers do not burn their bottoms. An 80%-efficient pump under the slide, submerged 1 m below the water surface, feeds a 5-m-long, 4-cm-diameter hose, of roughness 0.008 cm, to the slide. The hose discharges the water at the top of the slide, 4 m above the water surface, as a free jet. Ignore minor losses and assume  $\alpha = 1.06$ . Find the brake horsepower needed to drive the pump.

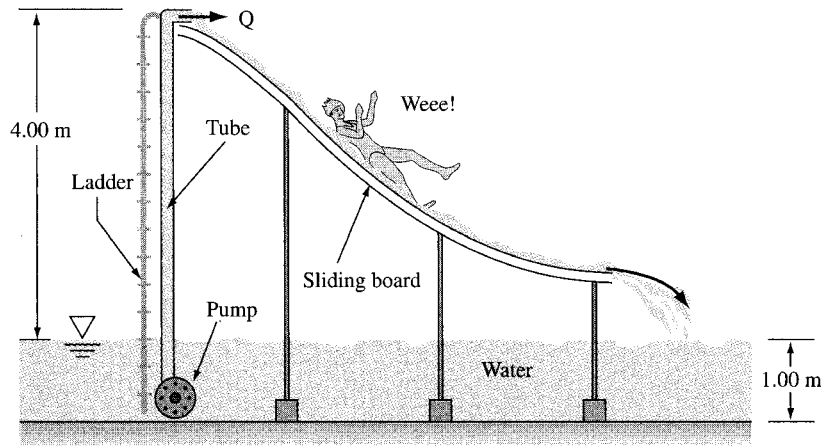


Fig. PC6.3

**Solution:** For water take  $\rho = 998 \text{ kg/m}^3$  and  $\mu = 0.001 \text{ kg/m}\cdot\text{s}$ . Write the steady-flow energy equation from the water surface (1) to the outlet (2) at the top of the slide:

$$\frac{p_a}{\rho g} + \frac{\alpha_1 V_1^2}{2g} + z_1 = \frac{p_a}{\rho g} + \frac{\alpha_2 V_2^2}{2g} + z_2 + h_f - h_{pump}, \quad \text{where } V_2 = \frac{1.39E-3}{\pi(0.02)^2} = 1.106 \frac{\text{m}}{\text{s}}$$

$$\text{Solve for } h_{pump} = (z_2 - z_1) + \frac{V_2^2}{2g} \left( \alpha_2 + f \frac{L}{d} \right)$$

Work out  $\text{Re}_d = \rho V d / \mu = (998)(1.106)(0.04) / 0.001 = 44200$ ,  $\epsilon/d = 0.008/4 = 0.002$ , whence  $f_{\text{Moody}} = 0.0268$ . Use these numbers to evaluate the pump head above:

$$h_{pump} = (5.0 - 1.0) + \frac{(1.106)^2}{2(9.81)} \left[ 1.06 + 0.0268 \left( \frac{5.0}{0.04} \right) \right] = 4.27 \text{ m},$$

$$\text{whence } \text{BHP}_{\text{required}} = \frac{\rho g Q h_{pump}}{\eta} = \frac{998(9.81)(1.39E-3)(4.27)}{0.8} = \mathbf{73 \text{ watts}} \quad \text{Ans.}$$

**C6.4** Suppose you build a house out in the ‘boonies,’ where you need to run a pipe to the nearest water supply, which fortunately is about 1 km above the elevation of your house. The gage pressure at the water supply is 1 MPa. You require a minimum of 3 gal/min when your end of the pipe is open to the atmosphere. To minimize cost, you want to buy the smallest possible diameter pipe with an extremely smooth surface.

(a) Find the total head loss from pipe inlet to exit, neglecting minor losses.

- (b) Which is more important to this problem, the head loss due to elevation difference, or the head loss due to pressure drop in the pipe?
- (c) Find the minimum required pipe diameter.

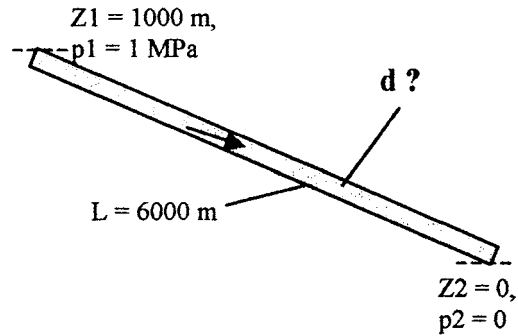


Fig. C6.4

**Solution:** Convert 3.0 gal/min to  $1.89\text{E-}4 \text{ m}^3/\text{s}$ . Let 1 be the inlet and 2 be the outlet and write the steady-flow energy equation:

$$\frac{p_{1\text{gage}}}{\rho g} + \frac{\alpha_1 V_1^2}{2g} + z_1 = \frac{p_{2\text{gage}}}{\rho g} + \frac{\alpha_2 V_2^2}{2g} + z_2 + h_f$$

or:  $h_f = z_1 - z_2 + \frac{p_{1\text{gage}}}{\rho g} = 1000 \text{ m} + \frac{1\text{E}6 \text{ kPa}}{998(9.81)} = 1000 + 102 = 1102 \text{ m}$  Ans. (a)

- (b) Thus, *elevation drop* of 1000 m is more important to head loss than  $\Delta p/\rho g = 102 \text{ m}$ .
- (c) To find the minimum diameter, iterate among flow rate and the Moody chart:

$$h_f = f \frac{L V^2}{d 2g}, \quad L = 6000 \text{ m}, \quad \frac{1}{\sqrt{f}} = -2 \log \left( \frac{2.51}{\text{Re} \sqrt{f}} \right), \quad V = \frac{Q}{\pi d^2/4},$$

$$Q = 1.89\text{E-}4 \frac{\text{m}^3}{\text{s}}, \quad \text{Re} = \frac{Vd}{\nu}$$

We are given  $h_f = 1102 \text{ m}$  and  $\nu_{\text{water}} = 1.005\text{E-}6 \text{ m}^2/\text{s}$ . We can iterate, if necessary, or use **EES**, which can swiftly arrive at the final result:

$f_{\text{smooth}} = 0.0266; \quad \text{Re} = 17924; \quad V = 1.346 \text{ m/s}; \quad d_{\text{min}} = 0.0134 \text{ m}$  Ans. (c)

**C6.5** Water at 20°C flows, at the same flow rate  $Q = 9.4\text{E-}4 \text{ m}^3/\text{s}$ , through two ducts, one a round pipe, and one an annulus, as shown. The cross-section area  $A$  of each duct is identical, and each has walls of commercial steel. Both are the same length. In the cross-sections shown,  $R = 15 \text{ mm}$  and  $a = 25 \text{ mm}$ .

- (a) Calculate the correct radius  $b$  for the annulus.
- (b) Compare head loss per unit length for the two ducts, first using the hydraulic diameter and second using the ‘effective diameter’ concept.
- (c) If the losses are different, why? Which duct is more ‘efficient’? Why?

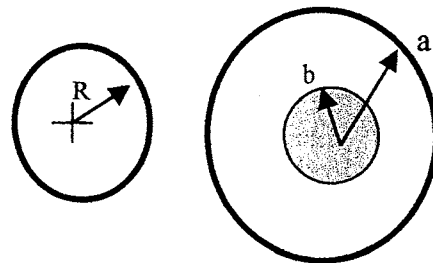


Fig. C6.5

**Solution:** (a) Set the areas equal:

$$A = \pi R^2 = \pi(a^2 - b^2), \quad \text{or: } b = \sqrt{a^2 - R^2} = \sqrt{(25)^2 - (15)^2} = 20 \text{ mm} \quad \text{Ans. (a)}$$

(b) Find the round-pipe head loss, assuming  $\nu = 1.005\text{E-}6 \text{ m}^2/\text{s}$ :

$$V = \frac{Q}{A} = \frac{9.4\text{E-}4 \text{ m}^3/\text{s}}{\pi(0.015 \text{ m})^2} = 1.33 \frac{\text{m}}{\text{s}}; \quad \text{Re} = \frac{(1.33)(0.030)}{1.005\text{E-}6} = 39700;$$

$$\frac{\varepsilon}{d} = 0.00153, \quad f_{\text{Moody}} = 0.0261$$

$$\text{Thus } h_f/L = (f/d)(V^2/2g) = (0.0261/0.03)(1.33^2)/2/9.81 = \mathbf{0.0785} \quad (\text{round}) \quad \text{Ans. (b)}$$

Annulus:  $D_h = 4A/P = 2(a-b) = 20 \text{ mm}$ , same  $V = 1.33 \text{ m/s}$ :

$$\text{Re}_{D_h} = \frac{VD_h}{\nu} = 26500, \quad \frac{\varepsilon}{D_h} = 0.0023, \quad f_{\text{Moody}} = 0.0291,$$

$$h_f/L \approx \left( \frac{f}{D_h} \frac{V^2}{2g} \right) \approx \mathbf{0.131} \quad (\text{annulus}) \quad \text{Ans. (b)}$$

Effective-diameter concept:  $b/a = 0.8$ , Table 6.3:  $D_{\text{eff}} = 0.667D_h = 13.3 \text{ mm}$ . Then

$$\text{Re}_{D_{\text{eff}}} = 17700, \quad \frac{\varepsilon}{D_{\text{eff}}} = 0.00345, \quad f_{\text{Moody}} = 0.0327,$$

$$\frac{h_f}{L} = \frac{f}{D_h} \frac{V^2}{2g} = \mathbf{0.147} \quad (\text{annulus—}D_{\text{eff}}) \quad \text{Ans. (b)}$$

NOTE: Everything here uses  $D_{\text{eff}}$  except  $h_f$ , which by definition uses  $D_h$ !

We see that the annulus has about 85% more head loss than the round pipe, for the same area and flow rate! This is because the annulus has more wall area, thus more friction. *Ans. (c)*

**C6.6** John Laufer (*NACA Tech. Rep.* 1174, 1954) gave velocity data for 20°C airflow in a smooth 24.7-cm-diameter pipe at  $\text{Re} \approx 5\text{E}5$ :

$u/u_{\text{CL}}$ :	1.0	0.997	0.988	0.959	0.908	0.847	0.818	0.771	0.690
$r/R$ :	0.0	0.102	0.206	0.412	0.617	0.784	0.846	0.907	0.963

The centerline velocity  $u_{\text{CL}}$  was 30.5 m/s. Determine (a) the average velocity by numerical integration and (b) the wall shear stress from the log-law approximation. Compare with the Moody chart and with Eq. (6.43).



**Solution:** For air at 20°C, take  $\rho = 1.2 \text{ kg/m}^3$  and  $\mu = 0.00018 \text{ kg/m}\cdot\text{s}$ . The average velocity is defined by the (dimensionless) integral

$$V = \frac{1}{\pi R^2} \int_0^R u(2\pi r)dr, \quad \text{or:} \quad \frac{V}{u_{CL}} = \int_0^1 \frac{u}{u_{CL}} 2\eta d\eta, \quad \text{where } \eta = \frac{r}{R}$$

Prepare a spreadsheet with the data and carry out the integration by the trapezoidal rule:

$$\int_0^1 \frac{u}{u_c} 2\eta d\eta \approx [(u/u_c)_2 \eta_2 + (u/u_c)_1 \eta_1](\eta_2 - \eta_1) + [(u/u_c)_3 \eta_3 + (u/u_c)_2 \eta_2](\eta_3 - \eta_2) + \dots$$

The integral is evaluated on the spreadsheet below. The result is  $V/u_{CL} \approx 0.8356$ ,

$$\text{or } V \approx (0.8356)(30.5) \approx \mathbf{25.5 \text{ m/s.}} \quad \text{Ans. (a)}$$

The wall shear stress is estimated by fitting the log-law (6.28) to each data point:

$$\text{For each } (u,y), \quad \frac{u}{u^*} \approx \frac{1}{\kappa} \ln\left(\frac{yu^*}{\nu}\right) + B, \quad \kappa \approx 0.41 \quad \text{and} \quad B \approx 5.0$$

We know  $\nu$  for air and are given  $u$  and  $y$  from the data, hence we can solve for  $u^*$ . The spreadsheet gives  $u^* \approx 1.1 \text{ m/s} \pm 1\%$ , or  $\tau_w = \rho u^{*2} = (1.2)(1.1)^2 \approx \mathbf{1.45 \text{ Pa.}}$  Ans. (b)

$y/R$	$r/R$	$u/u_{CL}$	$\int u/u_{CL} 2\pi r/R dr/R$	$u^*$
1.000	0.000	1.000	.0000	—
0.898	0.102	0.997	.0104	1.126
0.794	0.206	0.988	.0421	1.128
0.588	0.412	0.959	.1654	1.126
0.383	0.617	0.908	.3613	1.112
0.216	0.784	0.847	.5657	1.099
0.154	0.846	0.818	.6498	1.101
0.093	0.907	0.771	.7347	1.098
0.037	0.963	0.690	.8111	1.097
0.000	1.000	0.000	<b>.8356</b>	—

We make similar estimates from the Moody chart by evaluating  $Re$  and  $f$  and iterating:

$$\text{Guess } V \approx 25 \text{ m/s, then } Re = \frac{1.2(25)(0.247)}{0.00018} \approx 412000, \quad f_{\text{smooth}} \approx 0.0136$$

$$V_{\text{better}} = u_{CL} / [1 + 1.3\sqrt{f}] \approx 26.5, \quad \text{whence } Re \approx 436000, \quad f_{\text{better}} \approx 0.0135$$

This converges to  $V \approx \mathbf{26.5 \text{ m/s}}$  Ans. and  $\tau_w = (f/8)\rho V^2 \approx \mathbf{1.42 \text{ Pa.}}$  Ans.

---

**C6.7** Consider energy exchange in fully-developed laminar flow between parallel plates, as in Eq. (6.63). Let the pressure drop over a length  $L$  be  $\Delta p$ . Calculate the rate of work done by this pressure drop on the fluid in the region ( $0 < x < L$ ,  $-h < y < +h$ ) and compare with the integrated energy dissipated due to the viscous function  $\Phi$  from Eq. (4.50) over this same region. The two should be equal. Explain why this is so. Can you relate the viscous drag force and the wall shear stress to this energy result?

**Solution:** From Eq. (6.63), the velocity profile between the plates is parabolic:

$$u = \frac{3}{2}V \left(1 - \frac{y^2}{h^2}\right) \quad \text{where } V = \frac{h^2}{3\mu} \frac{\Delta p}{L} \text{ is the average velocity}$$

Let the width of the flow be denoted by  $b$ . The work done by pressure drop  $\Delta p$  is:

$$\dot{W}_{\text{pressure}} = \Delta p VA = \left(\frac{3\mu LV}{h^2}\right)(V)(2hb) = \frac{6\mu LbV^2}{h}$$

Meanwhile, from Eq. (4.50), the viscous dissipation function for this fully-developed flow is:

$$\Phi = \mu \left(\frac{\partial u}{\partial y}\right)^2 = \mu \left(\frac{3Vy}{h^2}\right)^2 = \frac{9\mu V^2 y^2}{h^4}$$

Integrate this to get the total dissipated energy over the entire flow region of dimensions  $L$  by  $b$  by  $2h$ :

$$\dot{E}_{\text{dissipated}} = Lb \int_{-h}^{+h} \left(\frac{9\mu V^2 y^2}{h^4}\right) dy = \frac{6\mu LbV^2}{h} = \dot{W}_{\text{pressure}} ! \quad \text{Ans.}$$

The two energy terms are equal. There is no work done by the wall shear stresses (where  $u = 0$ ), so the pressure work is entirely absorbed by viscous dissipation within the flow field. *Ans.*

---

## Chapter 7 • Flow Past Immersed Bodies

**7.1** For flow at 20 m/s past a thin flat plate, estimate the distances  $x$  from the leading edge at which the boundary layer thickness will be either 1 mm or 10 cm, for (a) air; and (b) water at 20°C and 1 atm.

**Solution:** (a) For air, take  $\rho = 1.2 \text{ kg/m}^3$  and  $\mu = 1.8\text{E-}5 \text{ kg/m}\cdot\text{s}$ . Guess laminar flow:

$$\frac{\delta_{\text{laminar}}}{x} = \frac{5.0}{\text{Re}_x^{1/2}}, \quad \text{or: } x = \frac{\delta^2 \rho U}{25\mu} = \frac{(0.001)^2 (1.2)(20)}{25(1.8\text{E-}5)} = \mathbf{0.0533 \text{ m}} \quad \text{Ans. (air—1 mm)}$$

$$\text{Check } \text{Re}_x = 1.2(20)(0.0533)/1.8\text{E-}5 = 71,000 \quad \text{OK, laminar flow}$$

(a) For the thicker boundary layer, guess turbulent flow:

$$\frac{\delta_{\text{turb}}}{x} = \frac{0.16}{(\rho U x / \mu)^{1/7}}, \quad \text{solve for } \mathbf{x = 6.06 \text{ m}} \quad \text{Ans. (a—10 cm)}$$

$$\text{Check } \text{Re}_x = 8.1\text{E}6, \quad \text{OK, turbulent flow}$$

(b) For water, take  $\rho = 998 \text{ kg/m}^3$  and  $\mu = 0.001 \text{ kg/m}\cdot\text{s}$ . Both cases are probably turbulent:

$$\delta = 1 \text{ mm: } \mathbf{x_{\text{turb}} = 0.0442 \text{ m}}, \quad \text{Re}_x = 882,000 \text{ (barely turbulent)} \quad \text{Ans. (water—1 mm)}$$

$$\delta = 10 \text{ cm: } \mathbf{x_{\text{turb}} = 9.5 \text{ m}}, \quad \text{Re}_x = 1.9\text{E}8 \text{ (OK, turbulent)} \quad \text{Ans. (water—10 cm)}$$

**7.2** Air, equivalent to a Standard Altitude of 4000 m, flows at 450 mi/h past a wing which has a thickness of 18 cm, a chord length of 1.5 m, and a wingspan of 12 m. What is the appropriate value of the Reynolds number for correlating the lift and drag of this wing? Explain your selection.

**Solution:** Convert 450 mi/h = 201 m/s, at 4000 m,  $\rho = 0.819 \text{ kg/m}\cdot\text{s}$ ,  $T = 262 \text{ K}$ ,  $\mu = 1.66\text{E-}5 \text{ kg/m}\cdot\text{s}$ . The appropriate length is the *chord*,  $C = 1.5 \text{ m}$ , and the best parameter to correlate with lift and drag is  $\mathbf{Re_C = (0.819)(201)(1.5)/1.66\text{E-}5 = 1.5\text{E}7}$  Ans.

**7.3** Equation (7.1b) assumes that the boundary layer on the plate is turbulent from the leading edge onward. Devise a scheme for determining the boundary-layer thickness more accurately when the flow is laminar up to a point  $\text{Re}_{x,\text{crit}}$  and turbulent thereafter. Apply this scheme to computation of the boundary-layer thickness at  $x = 1.5 \text{ m}$  in 40 m/s

flow of air at 20°C and 1 atm past a flat plate. Compare your result with Eq. (7.1b). Assume  $Re_{x,crit} \approx 1.2E6$ .

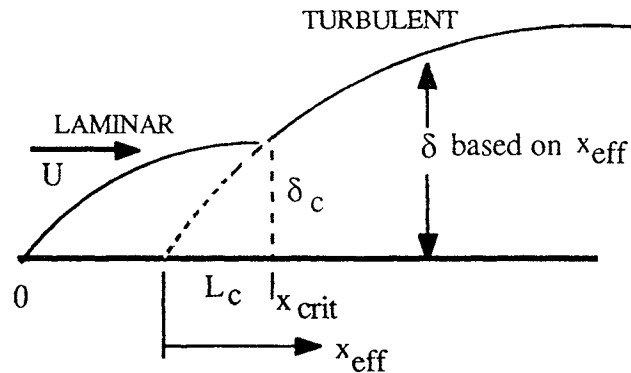


Fig. P7.3

**Solution:** Given the transition point  $x_{crit}$ ,  $Re_{crit}$ , calculate the laminar boundary layer thickness  $\delta_c$  at that point, as shown above,  $\delta_c/x_c \approx 5.0/Re_{crit}^{1/2}$ . Then find the “apparent” distance upstream,  $L_c$ , which gives the same *turbulent* boundary layer thickness,  $\delta_c/L_c \approx 0.16/Re_{L_c}^{1/7}$ . Then begin  $x_{effective}$  at this “apparent origin” and calculate the remainder of the turbulent boundary layer as  $\delta/x_{eff} \approx 0.16/Re_{eff}^{1/7}$ . Illustrate with a numerical example as requested. For air at 20°C, take  $\rho = 1.2 \text{ kg/m}^3$  and  $\mu = 1.8E-5 \text{ kg/m}\cdot\text{s}$ .

$$Re_{crit} = 1.2E6 = \frac{1.2(40)x_c}{1.8E-5} \quad \text{if } x_c = 0.45 \text{ m, then } \delta_c = \frac{5.0(0.45)}{(1.2E6)^{1/2}} \approx 0.00205 \text{ m}$$

$$\text{Compute } L_c = \left( \frac{\delta_c}{0.16} \right)^{7/6} \left( \frac{\rho U}{\mu} \right)^{1/6} = \left( \frac{0.00205}{0.16} \right)^{7/6} \left[ \frac{1.2(40)}{1.8E-5} \right]^{1/6} \approx 0.0731 \text{ m}$$

Finally, at  $x = 1.5 \text{ m}$ , compute the effective distance and the effective Reynolds number:

$$x_{eff} = x + L_c - x_c = 1.5 + 0.0731 - 0.45 = 1.123 \text{ m, } Re_{eff} = \frac{1.2(40)(1.123)}{1.8E-5} \approx 2.995E6$$

$$\delta|_{1.5 \text{ m}} \approx \frac{0.16x_{eff}}{Re_{eff}^{1/7}} = \frac{0.16(1.123)}{(2.995E6)^{1/7}} \approx \mathbf{0.0213 \text{ m}} \quad \text{Ans.}$$

Compare with a straight all-turbulent-flow calculation from Eq. (7.1b):

$$Re_x = \frac{1.2(40)(1.5)}{1.8E-5} \approx 4.0E6, \quad \text{whence } \delta|_{1.5 \text{ m}} \approx \frac{0.16(1.5)}{(4.0E6)^{1/7}} \approx \mathbf{0.027 \text{ m}} \quad (25\% \text{ higher}) \quad \text{Ans.}$$

**7.4** A smooth ceramic sphere ( $SG = 2.6$ ) is immersed in a flow of water at 20°C and 25 cm/s. What is the sphere diameter if it is encountering (a) creeping motion,  $Re_d = 1$ ; or (b) transition to turbulence,  $Re_d = 250,000$ ?

**Solution:** For water, take  $\rho = 998 \text{ kg/m}^3$  and  $\mu = 0.001 \text{ kg/m}\cdot\text{s}$ .

(a) Set  $\text{Re}_d$  equal to 1:

$$\text{Re}_d = 1 = \frac{\rho V d}{\mu} = \frac{(998 \text{ kg/m}^3)(0.25 \text{ m/s})d}{0.001 \text{ kg/m}\cdot\text{s}}$$

Solve for  $\mathbf{d = 4E-6 \text{ m} = 4 \mu\text{m}}$  *Ans. (a)*

(b) Similarly, at the transition Reynolds number,

$$\text{Re}_d = 250000 = \frac{(998 \text{ kg/m}^3)(0.25 \text{ m/s})d}{0.001 \text{ kg/m}\cdot\text{s}}, \text{ solve for } \mathbf{d = 1.0 \text{ m}}$$
 *Ans. (b)*

**7.5** SAE 30 oil at  $20^\circ\text{C}$  flows at  $1.8 \text{ ft}^3/\text{s}$  from a reservoir into a 6-in-diameter pipe. Use flat-plate theory to estimate the position  $x$  where the pipe-wall boundary layers meet in the center. Compare with Eq. (6.5), and give some explanations for the discrepancy.

**Solution:** For SAE 30 oil at  $20^\circ\text{C}$ , take  $\rho = 1.73 \text{ slug/ft}^3$  and  $\mu = 0.00607 \text{ slug/ft}\cdot\text{s}$ . The average velocity and pipe Reynolds number are:

$$V_{\text{avg}} = \frac{Q}{A} = \frac{1.8}{(\pi/4)(6/12)^2} = 9.17 \frac{\text{ft}}{\text{s}}, \quad \text{Re}_D = \frac{\rho V D}{\mu} = \frac{1.73(9.17)(6/12)}{0.00607} = 1310 \text{ (laminar)}$$

Using Eq. (7.1a) for laminar flow, find “ $x_e$ ” where  $\delta = D/2 = 3$  inches:

$$x_e \approx \frac{\delta^2 \rho V}{25\mu} = \frac{(3/12)^2 (1.73)(9.17)}{25(0.00607)} \approx \mathbf{6.55 \text{ ft}}$$
 *Ans. (flat-plate boundary layer estimate)*

This is far from the truth, much too short. Equation (6.5) for laminar pipe flow predicts

$$x_e = 0.06D \text{Re}_D = 0.06(6/12 \text{ ft})(1310) \approx \mathbf{39 \text{ ft}}$$
 *Alternate Ans.*

The entrance flow is **accelerating**, as the core velocity increases from  $V$  to  $2V$ , and the accelerating **boundary layer is much thinner** and takes much longer to grow to the center. *Ans.*

**7.6** For the laminar parabolic boundary-layer profile of Eq. (7.6), compute the shape factor “ $H$ ” and compare with the exact Blasius-theory result, Eq. (7.31).

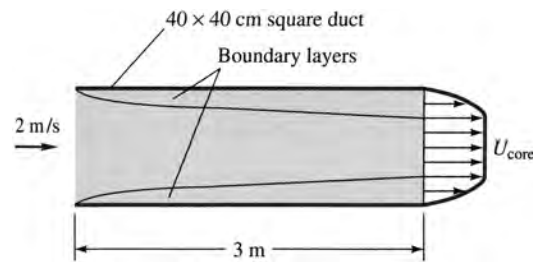
**Solution:** Given the profile approximation  $u/U \approx 2\eta - \eta^2$ , where  $\eta = y/\delta$ , compute

$$\theta = \int_0^{\delta} \frac{u}{U} \left(1 - \frac{u}{U}\right) dy = \delta \int_0^1 (2\eta - \eta^2)(1 - 2\eta + \eta^2) d\eta = \frac{2}{15} \delta$$

$$\delta^* = \int_0^{\delta} \left(1 - \frac{u}{U}\right) dy = \delta \int_0^1 (1 - 2\eta + \eta^2) d\eta = \frac{1}{3} \delta$$

Hence  $H = \delta^*/\theta = (\delta/3)/(2\delta/15) \approx \mathbf{2.5}$  (compared to 2.59 for Blasius solution)

**7.7** Air at 20°C and 1 atm enters a 40-cm-square duct as in Fig. P7.7. Using the “displacement thickness” concept of Fig. 7.4, estimate (a) the mean velocity and (b) the mean pressure in the core of the flow at the position  $x = 3$  m. (c) What is the average gradient, in Pa/m, in this section?



**Fig. P7.7**

**Solution:** For air at 20°C, take  $\rho = 1.2$  kg/m<sup>3</sup> and  $\mu = 1.8E-5$  kg/m·s. Using laminar boundary-layer theory, compute the displacement thickness at  $x = 3$  m:

$$Re_x = \frac{\rho U x}{\mu} = \frac{1.2(2)(3)}{1.8E-5} = 4E5 \text{ (laminar)}, \quad \delta^* = \frac{1.721x}{Re_x^{1/2}} = \frac{1.721(3)}{(4E5)^{1/2}} \approx 0.0082 \text{ m}$$

$$\begin{aligned} \text{Then, by continuity, } V_{exit} &= V \left( \frac{L_o}{L_o - 2\delta^*} \right)^2 = (2.0) \left( \frac{0.4}{0.4 - 0.0164} \right)^2 \\ &\approx \mathbf{2.175 \frac{m}{s}} \quad \text{Ans. (a)} \end{aligned}$$

The pressure change in the (frictionless) core flow is estimated from Bernoulli's equation:

$$p_{exit} + \frac{\rho}{2} V_{exit}^2 = p_o + \frac{\rho}{2} V_o^2, \quad \text{or: } p_{exit} + \frac{1.2}{2} (2.175)^2 = 1 \text{ atm} + \frac{1.2}{2} (2.0)^2$$

$$\text{Solve for } p|_{x=3m} = 1 \text{ atm} - 0.44 \text{ Pa} = \mathbf{0.56 \text{ Pa}} \quad \text{Ans. (b)}$$

The average pressure gradient is  $\Delta p/x = (-0.44/3.0) \approx \mathbf{-0.15 \text{ Pa/m}}$  Ans. (c)

**7.8** Air,  $\rho = 1.2 \text{ kg/m}^3$  and  $\mu = 1.8\text{E-}5 \text{ kg/m}\cdot\text{s}$ , flows at 10 m/s past a flat plate. At the trailing edge of the plate, the following velocity profile data are measured:

$y$ , mm:	0	0.5	1.0	2.0	3.0	4.0	5.0	6.0
$u$ , m/s:	0	1.75	3.47	6.58	8.70	9.68	10.0	10.0
$u(U - u)$ , $\text{m}^2/\text{s}$ :	0	14.44	22.66	22.50	11.31	3.10	0.0	0.0

If the upper surface has an area of  $0.6 \text{ m}^2$ , estimate, using momentum concepts, the friction drag, in newtons, on the upper surface.

**Solution:** Make a numerical estimate of drag from Eq. (7.2):  $F = \rho b \int u(U - u) dy$ . We have added the numerical values of  $u(U - u)$  to the data above. Using the trapezoidal rule between each pair of points in this table yields

$$\int_0^{\delta} u(U - u) dy \approx \frac{1}{1000} \left[ 0.5 \left( \frac{0 + 14.44}{2} \right) + \left( \frac{14.44 + 22.66}{2} \right) + \dots \right] \approx 0.061 \frac{\text{m}^3}{\text{s}}$$

The drag is approximately  $F = 1.2b(0.061) = 0.073b$  newtons or **0.073 N/m**. *Ans.*

**7.9** Repeat the flat-plate momentum analysis of Sec. 7.2 by replacing the parabolic profile, Eq. (7.6), with the more accurate sinusoidal profile:

$$\frac{u}{U} \approx \sin\left(\frac{\pi y}{2\delta}\right)$$

Compute momentum-integral estimates of  $C_f$ ,  $\delta/x$ ,  $\delta^*/x$ , and  $H$ .

**Solution:** Carry out the same integrations as Section 7.2, but results are more accurate:

$$\theta = \int_0^{\delta} \frac{u}{U} \left(1 - \frac{u}{U}\right) dy \approx \frac{4 - \pi}{2\pi} \delta = 0.1366\delta; \quad \delta^* = \int_0^{\delta} \left(1 - \frac{u}{U}\right) dy \approx \frac{\pi - 2}{\pi} \delta = 0.3634\delta$$

$$\tau_w \approx \mu \frac{\pi U}{2\delta} = \rho U^2 \frac{d}{dx} \left[ \frac{4 - \pi}{2\pi} \delta \right], \quad \text{integrate to: } \frac{\delta}{x} \approx \frac{\pi \sqrt{2} / \sqrt{(4 - \pi)}}{\sqrt{\text{Re}_x}} \approx \frac{4.80}{\sqrt{\text{Re}_x}} \quad (5\% \text{ low})$$

Substitute these results back to obtain the desired (accurate) dimensionless expressions:

$$\frac{\delta}{x} \approx \frac{4.80}{\sqrt{\text{Re}_x}}; \quad C_f = \frac{\theta}{x} \approx \frac{0.655}{\sqrt{\text{Re}_x}}; \quad \frac{\delta^*}{x} \approx \frac{1.743}{\sqrt{\text{Re}_x}}; \quad H = \frac{\delta^*}{\theta} \approx 2.66 \quad \text{Ans. (a, b, c, d)}$$

**7.10** Repeat Prob. 7.9, using the polynomial profile suggested by K. Pohlhausen in 1921:

$$\frac{u}{U} \approx 2\frac{y}{\delta} - 2\frac{y^3}{\delta^3} + \frac{y^4}{\delta^4}$$

Does this profile satisfy the boundary conditions of laminar flat-plate flow?

**Solution:** Pohlhausen's quadratic profile satisfies no-slip at the wall, a smooth merge with  $u \rightarrow U$  as  $y \rightarrow \delta$ , and, further, the boundary-layer curvature condition at the wall. From Eq. (7.19b),

$$\left( u \frac{\partial u}{\partial x} + v \frac{\partial u}{\partial y} - \frac{\mu}{\rho} \frac{\partial^2 u}{\partial y^2} \right)_{\text{wall}} = 0, \quad \text{or:} \quad \frac{\partial^2 u}{\partial y^2} \Big|_{\text{wall}} = 0 \quad \text{for flat-plate flow} \quad \left( \frac{\partial p}{\partial x} = 0 \right)$$

This profile gives the following integral approximations:

$$\theta \approx \frac{37}{315} \delta; \quad \delta^* \approx \frac{3}{10} \delta; \quad \tau_w \approx \mu \frac{2U}{\delta} \approx \rho U^2 \frac{d}{dx} \left( \frac{37}{315} \delta \right), \quad \text{integrate to obtain:}$$

$$\frac{\delta}{x} \approx \frac{\sqrt{(1260/37)}}{\sqrt{\text{Re}_x}} \approx \frac{5.83}{\sqrt{\text{Re}_x}}; \quad C_f = \frac{\theta}{x} \approx \frac{0.685}{\sqrt{\text{Re}_x}};$$

$$\frac{\delta^*}{x} \approx \frac{1.751}{\sqrt{\text{Re}_x}}; \quad H \approx 2.554 \quad \text{Ans. (a, b, c, d)}$$

**7.11** Air at 20°C and 1 atm flows at 2 m/s past a sharp flat plate. Assuming that the Kármán parabolic-profile analysis, Eqs. (7.6–7.10), is accurate, estimate (a) the local velocity  $u$ ; and (b) the local shear stress  $\tau$  at the position  $(x, y) = (50 \text{ cm}, 5 \text{ mm})$ .

**Solution:** For air, take  $\rho = 1.2 \text{ kg/m}^3$  and  $\mu = 1.8\text{E-}5 \text{ kg/m}\cdot\text{s}$ . First compute  $\text{Re}_x$  and  $\delta(x)$ : The location we want is  $y/\delta = 5 \text{ mm}/10.65 \text{ mm} = 0.47$ , and Eq. (7.6) predicts local velocity:

$$u(0.5 \text{ m}, 5 \text{ mm}) \approx U \left( \frac{2y}{\delta} - \frac{y^2}{\delta^2} \right) = (2 \text{ m/s}) [2(0.47) - (0.47)^2] = \mathbf{1.44 \text{ m/s}} \quad \text{Ans. (a)}$$

The local shear stress at this  $y$  position is estimated by differentiating Eq. (7.6):

$$\tau(0.5 \text{ m}, 5 \text{ mm}) = \mu \frac{\partial u}{\partial y} \approx \frac{\mu U}{\delta} \left( 2 - \frac{2y}{\delta} \right) = \frac{(1.8\text{E-}5 \text{ kg/m}\cdot\text{s})(2 \text{ m/s})}{0.01065 \text{ m}} [2 - 2(0.47)]$$

$$= \mathbf{0.0036 \text{ Pa}} \quad \text{Ans. (b)}$$



**7.12** The velocity profile shape  $u/U \approx 1 - \exp(-4.605y/\delta)$  is a smooth curve with  $u = 0$  at  $y = 0$  and  $u = 0.99U$  at  $y = \delta$  and thus would seem to be a reasonable substitute for the parabolic flat-plate profile of Eq. (7.3). Yet when this new profile is used in the integral analysis of Sec. 7.3, we get the lousy result  $\delta/x \approx 9.2/\text{Re}_x^{1/2}$ , which is 80 percent high. What is the reason for the inaccuracy? [Hint: The answer lies in evaluating the laminar boundary-layer momentum equation (7.19b) at the wall,  $y = 0$ .]

**Solution:** This profile satisfies no-slip at the wall and merges very smoothly with  $u \rightarrow U$  at the outer edge, but it does *not* have the right shape for flat-plate flow. It does not satisfy the zero curvature condition at the wall (see Prob. 7.10 for further details):

$$\text{Evaluate } \frac{\partial^2 u}{\partial y^2} \Big|_{y=0} \approx - \left( \frac{4.605}{\delta} \right)^2 U \approx - \frac{21.2U}{\delta^2} \neq 0 \quad \text{by a long measure!}$$

The profile has a **strong negative curvature** at the wall and simulates a **favorable pressure gradient shape**. Its momentum and displacement thickness are much too small.

**7.13** Derive modified forms of the laminar boundary-layer equations for flow along the outside of a circular cylinder of constant  $R$ , as in Fig. P7.13. Consider the two cases (a)  $\delta \ll R$ ; and (b)  $\delta \approx R$ . What are the boundary conditions?

**Solution:** The Navier-Stokes equations for cylindrical coordinates are given in Appendix D, with “ $x$ ” in the Fig. P7.13 denoting the axial coordinate “ $z$ .” Assume “axisymmetric” flow, that is,  $v_\theta = 0$  and  $\partial/\partial\theta = 0$  everywhere. The boundary layer assumptions are:

$$v_r \ll u; \quad \frac{\partial u}{\partial x} \ll \frac{\partial u}{\partial r}; \quad \frac{\partial v_r}{\partial x} \ll \frac{\partial v_r}{\partial r}; \quad \text{hence } r\text{-momentum (Eq. D-5) becomes } \frac{\partial p}{\partial r} \approx 0$$

Thus  $p \approx p(x)$  only, and for a long straight cylinder,  $p \approx \text{constant}$  and  $U \approx \text{constant}$

Then, with  $\partial p/\partial x = 0$ , the  $x$ -momentum equation (D-7 in the Appendix) becomes

$$\rho u \frac{\partial u}{\partial x} + \rho v_r \frac{\partial u}{\partial r} \approx \frac{\mu}{r} \frac{\partial}{\partial r} \left( r \frac{\partial u}{\partial r} \right) \quad \text{when } \delta \approx R \quad \text{Ans. (b)}$$

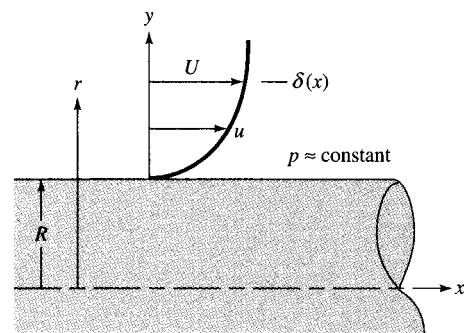


Fig. P7.13

plus continuity:  $\frac{\partial \mathbf{u}}{\partial x} + \frac{1}{r} \frac{\partial}{\partial r} (r \mathbf{v}_r) \approx 0$  when  $\delta \approx R$  Ans. (b)

For thick boundary layers (part *b*) the radial geometry is important.

If, however, the boundary layer is very thin,  $\delta \ll R$ , then  $r = R + y \approx R$  itself, and we can use  $(x, y)$ :

Continuity:  $\frac{\partial \mathbf{u}}{\partial x} + \frac{\partial \mathbf{v}_r}{\partial y} \approx 0$  if  $\delta \ll R$  Ans. (a)

x-momentum:  $\rho \mathbf{u} \frac{\partial \mathbf{u}}{\partial x} + \rho \mathbf{v}_r \frac{\partial \mathbf{u}}{\partial y} \approx \mu \frac{\partial^2 \mathbf{u}}{\partial y^2}$  if  $\delta \ll R$  Ans. (a)

Thus a thin boundary-layer on a cylinder is exactly the same as flat-plate (Blasius) flow.

**7.14** Show that the two-dimensional laminar-flow pattern with  $dp/dx = 0$

$$u = U_o(1 - e^{Cy}) \quad v = v_o < 0$$

is an exact solution to the boundary-layer equations (7.19). Find the value of the constant  $C$  in terms of the flow parameters. Are the boundary conditions satisfied? What might this flow represent?

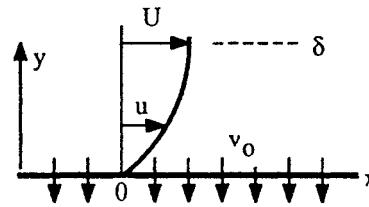


Fig. P7.14

**Solution:** Substitute these  $(u,v)$  into the x-momentum equation (7.19*b*) with  $\partial u / \partial x = 0$ :

$$\rho v \frac{\partial u}{\partial y} + \rho v \frac{\partial u}{\partial y} \approx \mu \frac{\partial^2 u}{\partial y^2}, \quad \text{or: } 0 + \rho(v_o)(-CU_o e^{Cy}) \approx \mu(-C^2 U_o e^{Cy}),$$

$$\text{or: } C = \rho v_o / \mu = \text{constant} < 0$$

If the constant is *negative*,  $u$  does not go to  $\infty$  and the solution represents laminar boundary-layer **flow past a flat plate with wall suction**,  $v_o \leq 0$  (see figure). It satisfies

$$\text{at } y = 0: u = 0 \text{ (no slip) and } v = v_o \text{ (suction); as } y \rightarrow \infty, u \rightarrow U_o \text{ (freestream)}$$

The thickness  $\delta$ , where  $u \approx 0.99U_o$ , is defined by  $\exp(\rho v_o \delta / \mu) = 0.01$ , or  $\delta = -4.6\mu / \rho v_o$ .

**7.15** Discuss whether fully developed laminar incompressible flow between parallel plates, Eq. (4.143) and Fig. 4.16b, represents an exact solution to the boundary-layer equations (7.19) and the boundary conditions (7.20). In what sense, if any, are duct flows also boundary-layer flows?

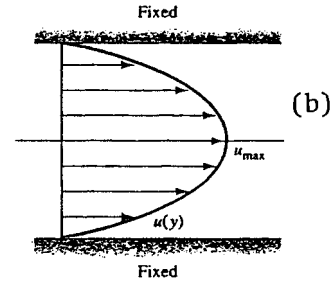


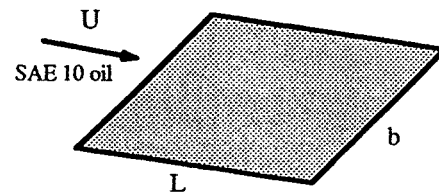
Fig. 4.16

**Solution:** The analysis for flow between parallel plates leads to Eq. (4.143):

$$u = \left(\frac{dp}{dx}\right) \frac{h^2}{2\mu} \left(1 - \frac{y^2}{h^2}\right); \quad v = 0; \quad \frac{dp}{dx} = \text{constant} < 0; \quad \frac{dp}{dy} = 0, \quad u(\pm h) = 0$$

It is indeed a “boundary layer,” with  $v \ll u$  and  $\partial p / \partial y \approx 0$ . The “freestream” is the centerline velocity,  $u_{\max} = (-dp/dx)(h^2/2\mu)$ . The boundary layer does not grow because it is constrained by the two walls. The entire duct is filled with boundary layer. *Ans.*

**7.16** A thin flat plate 55 by 110 cm is immersed in a 6-m/s stream of SAE 10 oil at 20°C. Compute the total friction drag if the stream is parallel to (a) the long side and (b) the short side.



**Solution:** For SAE 30 oil at 20°C, take  $\rho = 891 \text{ kg/m}^3$  and  $\mu = 0.29 \text{ kg/m}\cdot\text{s}$ .

$$(a) \quad L = 110 \text{ cm}, \quad Re_L = \frac{891(6.0)(1.1)}{0.29} = 20300 \text{ (laminar)}, \quad C_D = \frac{1.328}{(20300)^{1/2}} \approx 0.00933$$

$$F = C_D \left(\frac{\rho}{2}\right) U^2 (2bL) = 0.00933 \left(\frac{891}{2}\right) (6)^2 [2(0.55)(1.1)] \approx \mathbf{181 \text{ N}} \quad \text{Ans. (a)}$$

The drag is 41% *more* if we align the flow with the *short* side:

$$(b) \quad L = 55 \text{ cm}, \quad Re_L = 10140, \quad C_D = 0.0132, \quad F \approx \mathbf{256 \text{ N}} \text{ (41\% more)} \quad \text{Ans. (b)}$$

**7.17** Helium at 20°C and low pressure flows past a thin flat plate 1 m long and 2 m wide. It is desired that the total friction drag of the plate be 0.5 N. What is the appropriate absolute pressure of the helium if  $U = 35 \text{ m/s}$ ?

**Solution:** For helium at 20°C, take  $R = 2077 \text{ J/kg}\cdot\text{K}$  and  $\mu = 1.97\text{E}-5 \text{ kg/m}\cdot\text{s}$ . It is best to untangle the dimensionless drag coefficient relation to reveal the (unknown) density:

$$F = C_D \frac{\rho}{2} U^2 2bL = \frac{1.328\mu^{1/2}}{(\rho UL)^{1/2}} \left(\frac{\rho}{2}\right) U^2 (2bL) = 1.328b(\rho\mu L)^{1/2} U^{3/2},$$

or:  $0.5 \text{ N} = 1.328(2.0)[\rho(1.97\text{E}-5)(1.0)]^{1/2}(35)^{3/2}$ , solve for  $\rho \approx 0.0420 \text{ kg/m}^3$

$$\therefore p = \rho RT = (0.042)(2077)(293) \approx \mathbf{25500 \text{ Pa}} \quad \text{Ans.}$$

Check  $Re_L = \rho UL/\mu \approx 75000$ , OK, laminar flow.

**7.18** The approximate answers to Prob. 7.11 are  $u \approx 1.44 \text{ m/s}$  and  $\tau \approx 0.0036 \text{ Pa}$  at  $x = 50 \text{ cm}$  and  $y = 5 \text{ mm}$ . [Do not reveal this to your friends who are working on Prob. 7.11.] Repeat that problem by using the exact Blasius flat-plate boundary-layer solution.

**Solution:** (a) Calculate the Blasius variable  $\eta$  (Eq. 7.21), then find  $f' = u/U$  at that position:

$$\eta = y\sqrt{\frac{U}{\nu x}} = (0.005 \text{ m})\sqrt{\frac{2 \text{ m/s}}{(0.000015 \text{ m}^2/\text{s})(0.5 \text{ m})}} = 2.58,$$

Table 7.1:  $\frac{u}{U} \approx 0.768$ ,  $\therefore u \approx \mathbf{1.54 \text{ m/s}}$  Ans. (a)

(b) Differentiate Eq. (7.21) to find the local shear stress:

$$\tau = \mu \frac{\partial u}{\partial y} = \mu \frac{\partial}{\partial y} [Uf'(\eta)] = \mu U \sqrt{\frac{U}{\nu x}} f''(\eta). \quad \text{At } \eta = 2.58, \quad \text{estimate } f''(\eta) \approx 0.217$$

Then  $\tau \approx (0.000018)(2.0)\sqrt{\frac{(2.0)}{(0.000015)(0.5)}} (0.217) \approx \mathbf{0.0040 \text{ Pa}}$  Ans. (b)

**7.19** Program a method of numerical solution of the Blasius flat-plate relation, Eq. (7.22), subject to the conditions in (7.23). You will find that you cannot get started without knowing the initial second derivative  $f''(0)$ , which lies between 0.2 and 0.5. Devise an iteration scheme which starts at  $f''(0) \approx 0.2$  and converges to the correct value. Print out  $u/U = f'(\eta)$  and compare with Table 7.1.

**Solution:** This is a good exercise for students who are familiar with some integration scheme, such as Runge-Kutta, or have some built-in software, such as MathCAD. The solutions are very well behaved, that is, no matter what the guess for  $0.2 < f''(0) < 0.5$ , the value of  $f'(\eta)$  approaches a constant value as  $\eta \rightarrow \infty$ . The student can then easily

interpolate to the correct value  $f''(0) \approx 0.33206$ . One detail is that “ $\infty$ ” must be chosen and occurs at about  $\eta \approx 10$ .

**7.20** Air at 20°C and 1 atm flows at 20 m/s past the flat plate in Fig. P7.20. A pitot stagnation tube, placed 2 mm from the wall, develops a manometer head  $h = 16$  mm of Meriam red oil, SG = 0.827. Use this information to estimate the downstream position  $x$  of the pitot tube. Assume laminar flow.

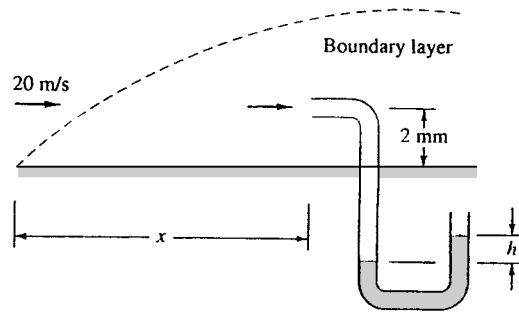


Fig. P7.20

**Solution:** For air at 20°C, take  $\rho = 1.2 \text{ kg/m}^3$  and  $\mu = 1.8\text{E-}5 \text{ kg/m}\cdot\text{s}$ . Assume constant stream pressure, then the manometer can be used to estimate the local velocity  $u$  at the position of the pitot inlet:

$$\Delta p_{\text{mano}} = p_o - p_\infty = (\rho_{\text{oil}} - \rho_{\text{air}})gh_{\text{mano}} = [0.827(998) - 1.2](9.81)(0.016) \approx 129 \text{ Pa}$$

$$\text{Then } u_{\text{pitot inlet}} \approx [2\Delta p/\rho]^{1/2} = [2(129)/1.2]^{1/2} \approx 14.7 \text{ m/s}$$

Now, with  $u$  known, the Blasius solution uses  $u/U$  to determine the position  $\eta$ :

$$\frac{u}{U} = \frac{14.7}{20} = 0.734, \quad \text{Table 7.1 read } \eta \approx 2.42 = y(U/\nu x)^{1/2}$$

$$\text{or: } x = (U/\nu)(y/\eta)^2 = (20/1.5\text{E-}5)(0.002/2.42)^2 \approx \mathbf{0.908 \text{ m}} \quad \text{Ans.}$$

Check  $Re_x = (20)(0.908)/(1.5\text{E-}5) \approx 1.21\text{E}6$ , OK, laminar if the flow is very smooth.

**7.21** For the experimental set-up of Fig. P7.20, suppose the stream velocity is unknown and the pitot stagnation tube is traversed across the boundary layer of air at 1 atm and 20°C. The manometer fluid is Meriam red oil, and the following readings are made:

y, mm:	0.5	1.0	1.5	2.0	2.5	3.0	3.5	4.0	4.5	5.0
h, mm:	1.2	4.6	9.8	15.8	21.2	25.3	27.8	29.0	29.7	29.7

Using this data only (not the Blasius theory) estimate (a) the stream velocity, (b) the boundary layer thickness, (c) the wall shear stress, and (d) the total friction drag between the leading edge and the position of the pitot tube.

**Solution:** As in Prob. 7.20, the air velocity  $u = [2(\rho_{\text{oil}} - \rho_{\text{air}})gh/\rho_{\text{air}}]^{1/2}$ . For the oil, take  $\rho_{\text{oil}} = 0.827(998) = 825 \text{ kg/m}^3$ . For air,  $\rho = 1.2 \text{ kg/m}^3$  and  $\mu = 1.8\text{E-}5 \text{ kg/m}\cdot\text{s}$ . (a, b) We see that  $h$  levels out to 29.7 mm at  $y = 4.5 \text{ mm}$ . Thus

$$U_{\infty} = [2(825 - 1.2)(9.81)(0.0297)/1.2]^{1/2} = \mathbf{20.0 \text{ m/s}} \quad \text{Ans. (a)} \quad \delta = \mathbf{4.5 \text{ mm}} \quad \text{Ans. (b)}$$

(c) The wall shear stress is estimated from the derivative of velocity at the wall:

$$\tau_w = \mu \left. \frac{\partial u}{\partial y} \right|_{y=0} \approx \mu \frac{\Delta u}{\Delta y} \approx (1.8\text{E-}5) \left( \frac{4.02 - 0}{0.0005 - 0} \right) \approx \mathbf{0.14 \text{ Pa}} \quad \text{Ans. (c)}$$

where we have calculated  $u_{\text{near-wall}} = [2(825 - 1.2)(9.81)(0.0012)/1.2]^{1/2} = 4.02 \text{ m/s}$ .

(d) To estimate drag, first see if the boundary layer is laminar. Evaluate  $Re_{\delta}$ :

$$Re_{\delta} = \frac{\rho U \delta}{\mu} = \frac{1.2(20)(0.0045)}{1.8\text{E-}5} \approx 6000, \quad \text{which implies } Re_{x,\text{laminar}} \approx 1.44\text{E}6$$

This is a little high, maybe, but let us assume a *smooth* wall, therefore laminar, in which case the drag is *twice the local shear stress times the wall area*. From Prob. 7.20, we estimated the distance  $x$  to be 0.908 m. Thus

$$\mathbf{F} \approx 2\tau_w xb = 2(0.14 \text{ Pa})(0.908 \text{ m})(1.0) \approx \mathbf{0.25 \text{ N}} \text{ per meter of width.} \quad \text{Ans. (d)}$$

**7.22** For the Blasius flat-plate problem, Eqs. (7.21) to (7.23), does a two-dimensional stream function  $\psi(x, y)$  exist? If so, determine the correct *dimensionless* form for  $\psi$ , assuming that  $\psi = 0$  at the wall,  $y = 0$ .

**Solution:** A stream function  $\psi(x, y)$  **does exist** because the flow satisfies the two-dimensional equation of continuity, Eq. (7.19a). That is,  $u = \partial\psi/\partial y$  and  $v = -\partial\psi/\partial x$ . Given the “Blasius” form of  $u$ , we may integrate to find  $\psi$ :

$$u = \frac{\partial\psi}{\partial y}, \quad \text{thus } \psi = \int u \, dy \Big|_{x=\text{const}} = \int_0^y \left( U \frac{df}{d\eta} \right) dy = \int_0^{\eta} \left( U \frac{df}{d\eta} \right) d\eta (\sqrt{vx/U})$$

$$\text{or } \psi = (vxU)^{1/2} \int_0^{\eta} df = (vxU)^{1/2} \mathbf{f} \quad \text{Ans.}$$

The integration assumes that  $\psi = 0$  at  $y = 0$ , which is very convenient.

**7.23** Suppose you buy a  $4 \times 8$ -ft sheet of plywood and put it on your roof rack, as in the figure. You drive home at 35 mi/h. (a) If the board is perfectly aligned with the airflow, how thick is the boundary layer at the end? (b) Estimate the drag if the flow remains laminar. (c) Estimate the drag for (smooth) turbulent flow.

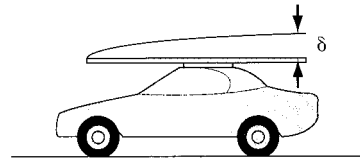


Fig. P7.23

**Solution:** For air take  $\rho = 1.2 \text{ kg/m}^3$  and  $\mu = 1.8\text{E-}5 \text{ kg/m}\cdot\text{s}$ . Convert  $L = 8 \text{ ft} = 2.44 \text{ m}$  and  $U = 35 \text{ mi/h} = 15.6 \text{ m/s}$ . Evaluate the Reynolds number, is it laminar or turbulent?

$$\text{Re}_L = \frac{\rho UL}{\mu} = \frac{1.2(15.6)(2.44)}{1.8\text{E-}5} = 2.55\text{E}6 \quad \text{probably laminar + turbulent}$$

(a) Evaluate the range of boundary-layer thickness between laminar and turbulent:

$$\text{Laminar: } \frac{\delta}{L} = \frac{\delta}{2.44 \text{ m}} \approx \frac{5.0}{\sqrt{2.55\text{E}6}} = 0.00313, \quad \text{or: } \delta \approx 0.00765 \text{ m} = \mathbf{0.30 \text{ in}}$$

$$\text{Turbulent: } \frac{\delta}{2.44} \approx \frac{0.16}{(2.55\text{E}6)^{1/7}} = 0.0195, \quad \text{or: } \delta \approx 0.047 \text{ m} = \mathbf{1.9 \text{ in}} \quad \text{Ans. (a)}$$

(b, c) Evaluate the range of boundary-layer drag for both laminar and turbulent flow. Note that, for flow over both sides, the appropriate area  $A = 2bL$ :

$$F_{\text{lam}} = C_D \frac{\rho}{2} U^2 A \approx \left( \frac{1.328}{\sqrt{2.55\text{E}6}} \right) \frac{1.2}{2} (15.6)^2 (2.44 \times 1.22 \times 2 \text{ sides}) = \mathbf{0.73 \text{ N}} \quad \text{Ans. (b)}$$

$$F_{\text{turb}} \approx \left( \frac{0.031}{(2.55\text{E}6)^{1/7}} \right) \frac{1.2}{2} (15.6)^2 (2.44 \times 1.22 \times 2 \text{ sides}) = \mathbf{3.3 \text{ N}} \quad \text{Ans. (c)}$$

We see that the turbulent drag is about 4 times larger than laminar drag.

**7.24** Air at  $20^\circ\text{C}$  and 1 atm flows past the flat plate in Fig. P7.24. The two pitot tubes are each 2 mm from the wall. The manometer fluid is water at  $20^\circ\text{C}$ . If  $U = 15 \text{ m/s}$  and  $L = 50 \text{ cm}$ , determine the values of the manometer readings  $h_1$  and  $h_2$  in cm. Assume laminar boundary-layer flow.

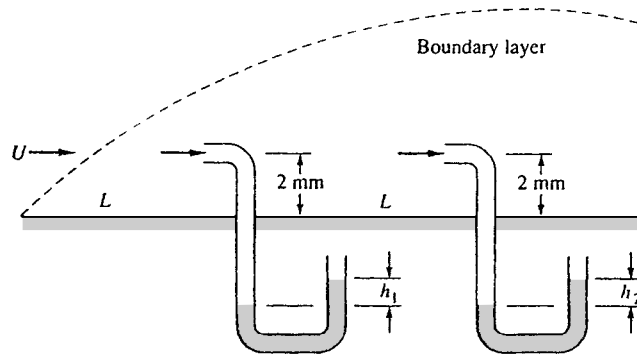


Fig. P7.24

**Solution:** For air at 20°C, take  $\rho = 1.2 \text{ kg/m}^3$  and  $\mu = 1.8\text{E-}5 \text{ kg/m}\cdot\text{s}$ . The velocities  $u$  at each pitot inlet can be estimated from the Blasius solution:

$$(1) \quad \eta_1 = y[U/\nu x_1]^{1/2} = (0.002)\{15/[1.5\text{E-}5(0.5)]\}^{1/2} = 2.83, \quad \text{Table 7.1: read } f' \approx 0.816$$

$$\text{Then } u_1 = Uf' = 15(0.816) \approx 12.25 \text{ m/s}$$

$$(2) \quad \eta_2 = y[U/\nu x_2]^{1/2} = 2.0, \quad f' \approx 0.630, \quad u_2 = 15(0.630) \approx 9.45 \text{ m/s}$$

Assume constant stream pressure, then the manometers are a measure of the local velocity  $u$  at each position of the pitot inlet, so we can find  $\Delta p$  across each manometer:

$$\Delta p_1 = \frac{\rho}{2} u_1^2 = \frac{1.2}{2} (12.25)^2 = 90 \text{ Pa} = \Delta \rho g h_1 = (998 - 1.2)(9.81)h_1, \quad \mathbf{h_1 \approx 9.2 \text{ mm}}$$

$$\Delta p_2 = \frac{\rho}{2} u_2^2 = \frac{1.2}{2} (9.45)^2 = 54 \text{ Pa} = (998 - 1.2)(9.81)h_2, \quad \text{or: } \mathbf{h_2 \approx 5.5 \text{ mm} \quad \text{Ans.}}$$

**7.25** Consider the smooth square 10 by 10 cm duct in Fig. P7.25. The fluid is air at 20°C and 1 atm, flowing at  $V_{\text{avg}} = 24 \text{ m/s}$ . It is desired to increase the pressure drop over the 1-m length by adding sharp 8-mm-long flat plates across the duct, as shown. (a) Estimate the pressure drop if there are no plates. (b) Estimate how many plates are needed to generate an additional 100 Pa of pressure drop.

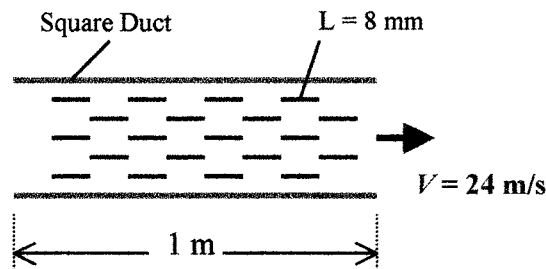


Fig. P7.25



**Solution:** For air, take  $\rho = 1.2 \text{ kg/m}^3$  and  $\mu = 1.8\text{E-}5 \text{ kg/m}\cdot\text{s}$ . (a) Compute the duct Reynolds number and hence the Moody-type pressure drop. The hydraulic diameter is 10 cm, thus

$$\text{Re}_{D_h} = \frac{VD_h}{\nu} = \frac{(24 \text{ m/s})(0.1 \text{ m})}{0.000015 \text{ m}^2/\text{s}} = 160000 \text{ (turbulent)} \quad f_{\text{smooth}} = 0.0163$$

$$\Delta p_{\text{Moody}} = f \frac{L}{D_h} \frac{\rho V^2}{2} = (0.0163) \left( \frac{1.0 \text{ m}}{0.1 \text{ m}} \right) \frac{(1.2 \text{ kg/m}^3)(24 \text{ m/s})^2}{2} = \mathbf{56 \text{ Pa}} \quad \text{Ans. (a)}$$

(b) To estimate the plate-induced pressure drop, first calculate the drag on one plate:

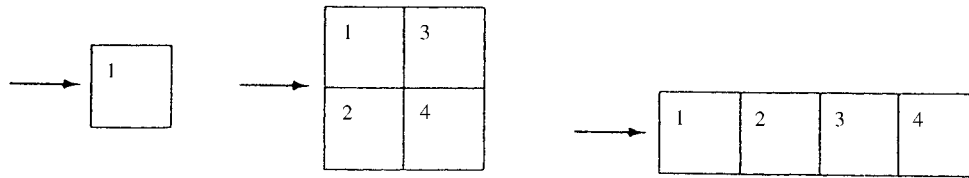
$$\text{Re}_L = \frac{(24)(0.008)}{0.000015} = 12800, \quad C_D = \frac{1.328}{\sqrt{12800}} = 0.0117,$$

$$F = C_D \frac{\rho}{2} V^2 bL (2 \text{ sides}) = (0.0117) \frac{1.2}{2} (24)^2 (0.1)(0.008)(2) = 0.00649 \text{ N}$$

Since the duct walls must support these plates, the effect is an additional pressure drop:

$$\Delta p_{\text{extra}} = 100 \text{ Pa} = \frac{FN_{\text{plates}}}{A_{\text{duct}}} = \frac{(0.00649 \text{ N})N_{\text{plates}}}{(0.1 \text{ m})^2}, \quad \text{or: } \mathbf{N_{\text{plates}} \approx 154} \quad \text{Ans. (b)}$$

**7.26** Consider laminar flow past the square-plate arrangements in the figure below. Compared to the drag of a single plate (1), how much larger is the drag of four plates together as in configurations (a) and (b)? Explain your results.



**Fig. P7.26 (a)**

**Fig. P7.26 (b)**

**Solution:** The laminar formula  $C_D = 1.328/\text{Re}_L^{1/2}$  means that  $C_D \propto L^{-1/2}$ . Thus:

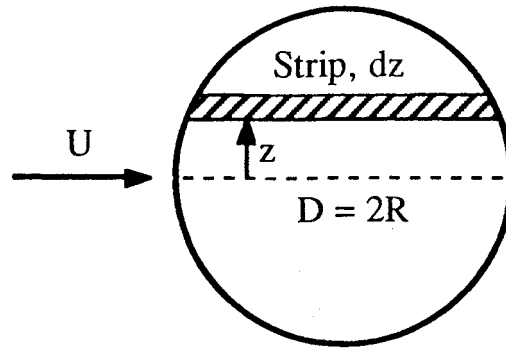
$$(a) F_a = \frac{\text{const}}{\sqrt{2L_1}} (4A_1) = \sqrt{8}F_1 = \mathbf{2.83F_1} \quad \text{Ans. (a)}$$

$$(b) F_b = \frac{\text{const}}{\sqrt{4L_1}} (4A_1) = \mathbf{2.0F_1} \quad \text{Ans. (b)}$$

The plates near the trailing edge have less drag because their boundary layers are thicker and their wall shear stresses are less. These configurations do *not* quadruple the drag.

**7.27** A thin smooth disk of diameter  $D$  is immersed parallel to a uniform stream of velocity  $U$ . Assuming laminar flow and using flat-plate theory as a guide, develop an approximate formula for the drag of the disk.

**Solution:** Divide the disk surface into strips of width  $dz$  and length  $L$  as shown. Assume that each strip is a flat plate of length  $L$  and integrate the differential drag force:



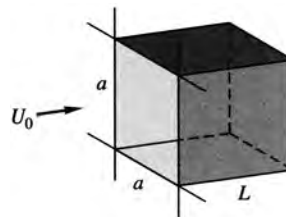
$$dF_{\text{strip}} = C_D \frac{\rho}{2} U^2 L dz (2 \text{ sides}), \quad \text{where } C_D = \frac{1.328}{\sqrt{(UL/\nu)}} \quad \text{and} \quad L = 2\sqrt{R^2 - z^2}$$

$$dF = 1.328(\rho\mu L)^{1/2} U^{3/2} dz, \quad F = 1.328(2\rho\mu)^{1/2} U^{3/2} \int_{-R}^{+R} (R^2 - z^2)^{1/4} dz$$

After integration, the final result can be written in dimensional or dimensionless form:

$$F = 3.28(\rho\mu)^{1/2} (UR)^{3/2} \quad \text{or:} \quad C_D = \frac{F}{(\rho/2)U^2\pi R^2} \approx \frac{2.96}{\sqrt{\rho UD/\mu}} \quad \text{Ans.}$$

**7.28** Flow straighteners are arrays of narrow ducts placed in wind tunnels to remove swirl and other in-plane secondary velocities. They can be idealized as square boxes constructed by vertical and horizontal plates, as in Fig. P7.28. The cross section is  $a$  by  $a$ , and the box length is  $L$ . Assuming laminar flat-plate flow and an array of  $N \times N$  boxes, derive a formula for (a) the total drag on the bundle of boxes and (b) the effective pressure drop across the bundle.



**Fig. P7.28**

**Solution:** For laminar flow over any one wall of size  $a$  by  $L$ , we estimate

$$\frac{F_{\text{one wall}}}{(1/2)\rho U^2 a L} \approx \frac{1.328}{\sqrt{(\rho U L / \mu)}}, \quad \text{or} \quad F_{\text{one wall}} \approx 0.664 (\rho \mu L)^{1/2} U^{3/2} a$$

Thus, for **4** walls and  $N^2$  boxes,  $F_{\text{total}} \approx \mathbf{2.656 N^2 (\rho \mu L)^{1/2} U^{3/2} a}$  Ans. (a)

The pressure drop across the array is thus

$$\Delta p_{\text{array}} = \frac{F_{\text{total}}}{(Na)^2} \approx \frac{\mathbf{2.656}}{a} (\rho \mu L)^{1/2} U^{3/2} \quad \text{Ans. (b)}$$

This is *completely* different from the predicted  $\Delta p$  for laminar flow through a square duct, as in Section 6.6:

$$\Delta p_{\text{duct}} = f \frac{L}{D_h} \frac{\rho}{2} U^2 = \left( \frac{56.91 \mu}{\rho U a} \right) \left( \frac{L}{a} \right) \frac{\rho}{2} U^2 \approx \frac{28.5 \mu L U}{a^2} \quad (?)$$

This has almost no relation to *Answer* (b) above, being the  $\Delta p$  for a long square duct filled with boundary layer. Answer (b) is for a very short duct with thin wall boundary layers.

**7.29** Let the flow straighteners in Fig. P7.28 form an array of  $20 \times 20$  boxes of size  $a = 4$  cm and  $L = 25$  cm. If the approach velocity is  $U_o = 12$  m/s and the fluid is sea-level standard air, estimate (a) the total array drag and (b) the pressure drop across the array. Compare with Sec. 6.6.

**Solution:** For sea-level air, take  $\rho = 1.205$  kg/m<sup>3</sup> and  $\mu = 1.78\text{E-}5$  kg/m·s. The analytical formulas for array drag and pressure drop are given above. Hence

$$F_{\text{array}} = 2.656 N^2 (\rho \mu L)^{1/2} U^{3/2} a = 2.656 (20)^2 [1.205 (1.78\text{E-}5) (0.25)]^{1/2} (12)^{3/2} (0.04)$$

or:  $\mathbf{F} \approx \mathbf{4.09\ N}$  ( $Re_L = 203000$ , OK, laminar) Ans. (a)

$$\Delta p_{\text{array}} = \frac{F}{(Na)^2} = \frac{4.09}{[20(0.04)]^2} \approx \mathbf{6.4\ Pa} \quad \text{Ans. (b)}$$

This is a far cry from the (much lower) estimate would have by assuming the array is a bunch of long square ducts as in Sect. 6.6 (as shown in Prob. 7.28):

$$\Delta p_{\text{long duct}} \approx \frac{28.5 \mu L U}{a^2} = \frac{28.5 (1.78\text{E-}5) (0.25) (12)}{(0.04)^2} \approx \mathbf{0.95\ Pa} \quad (\text{not accurate}) \quad \text{Ans.}$$

**7.30** Repeat Prob. 7.16 if the fluid is *water* at 20°C and the plate is *smooth*.

**Solution:** For water at 20°C, take  $\rho = 998 \text{ kg/m}^3$  and  $\mu = 0.001 \text{ kg/m}\cdot\text{s}$ . Recall the problem was a thin plate 55 cm by 110 cm immersed in SAE 30 oil flowing at 6 m/s, find the frictional drag force if the stream is aligned with (a) the long side; or (b) the short side. In Problem 7.16 the flow was *laminar* and the forces were (a) 181 N; and (b) 256 N. For water flow, we find that the boundary layer is *turbulent*:

$$(a) \quad L = 110 \text{ cm}, \quad \text{Re}_L = \frac{998(6)(1.1)}{0.001} \approx 6.59\text{E}6 \text{ (turbulent)}, \quad C_D \approx \frac{0.031}{\text{Re}_L^{1/7}} \approx 0.00329$$

$$\text{Then } F_{\text{drag}} = C_D \frac{\rho}{2} U^2 bL (2 \text{ sides}) = (0.00329) \left( \frac{998}{2} \right) (6)^2 (0.55)(1.1)(2) \approx \mathbf{72 \text{ N}} \quad \text{Ans. (a)}$$

$$(b) \quad L = 55 \text{ cm}, \quad \text{Re}_L = \frac{998(6)(0.55)}{0.001} \approx 3.29\text{E}6 \text{ (turbulent)}, \quad C_D \approx \frac{0.031}{\text{Re}_L^{1/7}} \approx 0.00363$$

$$\text{Then } F_{\text{drag}} = C_D \frac{\rho U^2}{2} (bL)(2 \text{ sides}) = (0.00363) \left( \frac{998}{2} \right) (6)^2 (1.1)(0.55)(2)$$

$$F_{\text{drag}} \approx \mathbf{79 \text{ N}} \quad \text{Ans. (b)}$$

**7.31** The centerboard on a sailboat is 3 ft long parallel to the flow and protrudes 7 ft down below the hull into seawater at 20°C. Using flat-plate theory for a smooth surface, estimate its drag if the boat moves at 10 knots. Assume  $\text{Re}_{x,tr} = 5\text{E}5$ .

**Solution:** For seawater, take  $\rho = 1.99 \text{ slug/ft}^3$  and  $\mu = 2.23\text{E}-5 \text{ slug/ft}\cdot\text{s}$ . Evaluate  $\text{Re}_L$  and the drag. Convert 10 knots to 16.9 ft/s.

$$\text{Re}_L = \frac{\rho UL}{\mu} = \frac{(1.99 \text{ slug/ft}^3)(16.9 \text{ ft/s})(3 \text{ ft})}{0.0000223 \text{ slug/ft}\cdot\text{s}} = 4.52\text{E}6 \text{ (turbulent)}$$

$$\text{From Eq. (7.49a), } C_D = \frac{0.031}{\text{Re}_L^{1/7}} - \frac{1440}{\text{Re}_L} = \frac{0.031}{(4.52\text{E}6)^{1/7}} - \frac{1440}{4.52\text{E}6}$$

$$= 0.00347 - 0.00032 = 0.00315$$

$$F_{\text{drag}} = C_D \frac{\rho}{2} V^2 bL (2 \text{ sides}) = 0.00315 \left( \frac{1.99}{2} \right) (16.9)^2 (3 \text{ ft})(7 \text{ ft})(2 \text{ sides}) = \mathbf{38 \text{ lbf}} \quad \text{Ans.}$$

**7.32** A flat plate of length  $L$  and height  $\delta$  is placed at a wall and is parallel to an approaching boundary layer, as in Fig. P7.32. Assume that the flow over the plate is fully turbulent and that the approaching flow is a one-seventh-power law

$$u(y) = U_o \left( \frac{y}{\delta} \right)^{1/7}$$

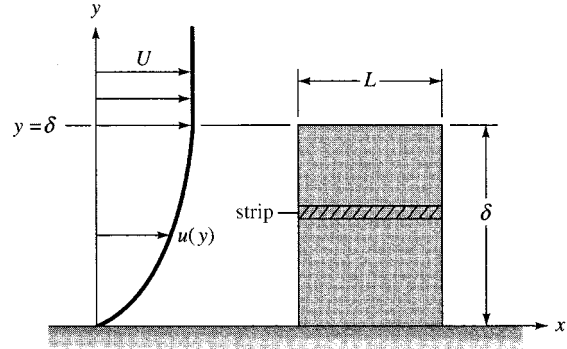


Fig. P7.32

Using strip theory, derive a formula for the drag coefficient of this plate. Compare this result with the drag of the same plate immersed in a uniform stream  $U_o$ .

**Solution:** For a 'strip' of plate  $dy$  high and  $L$  long, subjected to flow  $u(y)$ , the force is

$$dF = C_D \frac{\rho}{2} u^2 (L dy) (2 \text{ sides}), \quad \text{where } C_D \approx \frac{0.031}{(\rho u L / \mu)^{1/7}}, \quad \text{combine into } dF \text{ and integrate:}$$

$$dF = 0.031 \rho v^{1/7} L^{6/7} u^{13/7} dy, \quad \text{or } F = 0.031 \rho v^{1/7} L^{6/7} \int_0^\delta \left[ U_o (y/\delta)^{1/7} \right]^{13/7} dy$$

$$\text{The result is } \mathbf{F = 0.031(49/62) \rho v^{1/7} L^{6/7} U_o^{13/7} \delta} \quad \text{Ans.}$$

This drag is  $(49/62)$ , or 79%, of the force on the same plate immersed in a uniform stream.

**7.33** An alternate analysis of turbulent flat-plate flow was given by Prandtl in 1927, using a wall shear-stress formula from pipe flow

$$\tau_w = 0.0225 \rho U^2 \left( \frac{v}{U \delta} \right)^{1/4}$$

Show that this formula can be combined with Eqs. (7.32) and (7.40) to derive the following relations for turbulent flat-plate flow.

$$\frac{\delta}{x} = \frac{0.37}{\text{Re}_x^{1/5}} \quad c_f = \frac{0.0577}{\text{Re}_x^{1/5}} \quad C_D = \frac{0.072}{\text{Re}_L^{1/5}}$$

These formulas are limited to  $\text{Re}_x$  between  $5 \times 10^5$  and  $10^7$ .

**Solution:** Use Prandtl's correlation for the left hand side of Eq. (7.32) in the text:

$$\tau_w \approx 0.0225 \rho U^2 (\nu/U\delta)^{1/4} = \rho U^2 \frac{d\theta}{dx} \approx \rho U^2 \frac{d}{dx} \left( \frac{7}{72} \delta \right), \quad \text{cancel } \rho U^2 \text{ and rearrange:}$$

$$\delta^{1/4} d\delta = 0.2314 (\nu/U)^{1/4} dx, \quad \text{Integrate: } \frac{4}{5} \delta^{5/4} = 0.2314 (\nu/U)^{1/4} x$$

Take the (5/4)<sup>th</sup> root of both sides and rearrange for the final thickness result:

$$\delta \approx 0.37 (\nu/U)^{1/5} x^{4/5}, \quad \text{or: } \frac{\delta}{x} \approx \frac{0.37}{\text{Re}_x^{1/5}} \quad \text{Ans. (a)}$$

$$\text{Substitute } \delta(x) \text{ into } \tau_w: \quad C_f \approx \frac{2(0.0225)}{(0.37)^{1/4}} \left( \frac{\nu}{Ux} \right)^{1/5}, \quad \text{or } C_f \approx \frac{0.0577}{\text{Re}_x^{1/5}} \quad \text{Ans. (b)}$$

$$\text{Finally, } C_D = \int_0^1 C_f d\left(\frac{x}{L}\right) = \frac{5}{4} C_f(\text{at } x=L) \approx \frac{0.072}{\text{Re}_L^{1/5}} \quad \text{Ans. (c)}$$

**7.34** A thin equilateral-triangle plate is immersed parallel to a 12 m/s stream of water 20°C, as in Fig. P7.34. Assuming  $\text{Re}_{tr} = 5 \times 10^5$ , estimate the drag of this plate.

**Solution:** Use a strip  $dx$  long and  $(L-x)$  wide parallel to the leading edge of the plate, as shown in the figure. Let the side length of the triangle be  $a$ :

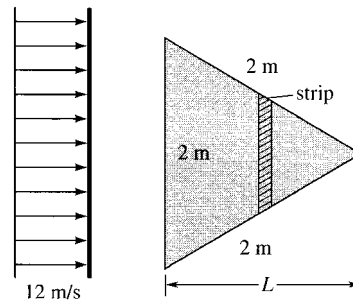


Fig. P7.34

Strip  $dA = 2(L-x) \tan 30^\circ dx$ , where  $L = a \sin 60^\circ$  and  $a = 2 \text{ m} = \text{side length}$ .

$$\text{Laminar part: } dF_{lam} = \tau_w dA = 0.332 \left( \frac{\rho\mu}{x} \right)^{1/2} U^{3/2} 2(L-x) \tan 30^\circ dx \quad (2 \text{ sides})$$

$$\text{Integrate from } 0 \text{ to } x_{crit}: \quad F_{lam} = 1.328 (\rho\mu)^{1/2} U^{3/2} \tan 30^\circ \left( 2Lx_{crit}^{1/2} - \frac{2}{3} x_{crit}^{3/2} \right)$$

$$\text{Turbulent part: } dF_{turb} = \tau_w dA = 0.027 \left( \frac{\rho U^2}{2} \right) \left( \frac{\nu}{Ux} \right)^{1/7} 2(L-x) \tan 30^\circ dx \quad (2 \text{ sides})$$

Integrate from  $x_{crit}$  to  $L$ :

$$F_{turb} = 0.054 \rho \nu^{1/7} U^{13/7} \tan 30^\circ \left[ \frac{7}{6} (L^{13/7} - Lx_{crit}^{6/7}) - \frac{7}{13} (L^{13/7} - x_{crit}^{13/7}) \right]$$

The total force is, of course,  $F_{\text{lam}} + F_{\text{turb}}$ . For the numerical values given,  $L = 1.732$  m. For water at  $20^\circ\text{C}$ , take  $\rho = 998$  kg/m<sup>3</sup> and  $\mu = 0.001$  kg/m·s. Evaluate  $x_{\text{crit}}$  and  $F$ :

$$Re_{\text{crit}} = 5E5 = \frac{\rho U x}{\mu} = \frac{998(12)x_{\text{crit}}}{0.001}, \quad \text{or: } x_{\text{crit}} = \mathbf{0.042 \text{ m}}$$

$$F_{\text{lam}} = 1.328[998(0.001)]^{1/2}(12)^{3/2} \tan 30^\circ \left[ 2(1.732)(0.042)^{1/2} - \frac{2}{3}(0.042)^{3/2} \right] = 22 \text{ N}$$

$$F_{\text{turb}} = 0.054(998) \left( \frac{0.001}{998} \right)^{1/7} (12)^{13/7} \tan 30^\circ \left[ \frac{7}{6} \{ (1.732)^{13/7} - 1.732(0.042)^{6/7} \} \right. \\ \left. - \frac{7}{13} \{ (1.732)^{13/7} - (0.042)^{13/7} \} \right] = 703 \text{ N}; \quad \therefore F_{\text{total}} = 22 + 703 = \mathbf{725 \text{ N}} \quad \text{Ans.}$$

**7.35** Repeat Problem 7.26 for *turbulent* flow. Explain your results.

**Solution:** The turbulent formula  $C_D = 0.031/Re_L^{1/7}$  means that  $C_D \propto L^{-1/7}$ . Thus:

$$(a) \quad F_a = \frac{\text{const}}{(2L_1)^{1/7}} (4A_1) = \mathbf{3.62F_1} \quad \text{Ans. (a)}$$

$$(b) \quad F_b = \frac{\text{const}}{(4L_1)^{1/7}} (4A_1) = \mathbf{3.28F_1} \quad \text{Ans. (b)}$$

The trailing areas have *slightly* less shear stress, hence we are *nearly* quadrupling drag.

**7.36** A ship is 125 m long and has a wetted area of 3500 m<sup>2</sup>. Its propellers can deliver a maximum power of 1.1 MW to seawater at  $20^\circ\text{C}$ . If all drag is due to friction, estimate the maximum ship speed, in kn.

**Solution:** For seawater at  $20^\circ\text{C}$ , take  $\rho = 1025$  kg/m<sup>3</sup> and  $\mu = 0.00107$  kg/m·s. Evaluate

$$Re_L = \frac{\rho UL}{\mu} = \frac{1025V(125)}{0.00107} \quad (\text{surely turbulent}), \quad C_D = \frac{0.031}{Re_L^{1/7}} = \frac{0.00217}{V^{1/7}}$$

$$\text{Power} = FV = \left[ \frac{0.0217}{V^{1/7}} \left( \frac{1025}{2} \right) V^2 (3500) \right] V = 1.1E6 \text{ watts}, \quad \text{or } V^{20/7} \approx 282.0$$

Solve for  $V = 7.2$  m/s  $\approx$  **14 knots.** Ans.

**7.37** Air at 20°C and 1 atm flows past a long flat plate, at the end of which is placed a narrow scoop, as shown in Fig. P7.37. (a) Estimate the height  $h$  of the scoop if it is to extract 4 kg/s per meter of width into the paper. (b) Find the drag on the plate up to the inlet of the scoop, per meter of width.

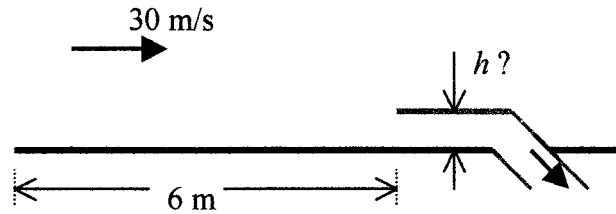


Fig. P7.37

**Solution:** For air, take  $\rho = 1.2 \text{ kg/m}^3$  and  $\mu = 1.8\text{E-}5 \text{ kg/m}\cdot\text{s}$ . We assume that the scoop does not alter the boundary layer at its entrance. (a) Compute the displacement thickness at  $x = 6 \text{ m}$ :

$$\text{Re}_x = \frac{Ux}{\nu} = \frac{(30 \text{ m/s})(6 \text{ m})}{0.000015 \text{ m}^2/\text{s}} = 1.2\text{E}7, \quad \frac{\delta^*}{x} \approx \frac{1}{8} \left( \frac{0.16}{\text{Re}_x^{1/7}} \right) = \frac{0.020}{(1.2\text{E}7)^{1/7}} = 0.00195$$

$$\delta^*|_{x=6 \text{ m}} = (6 \text{ m})(0.00195) = 0.0117 \text{ m}$$

If  $\delta^*$  were zero, the flow into the scoop would be uniform:  $4 \text{ kg/s/m} = \rho U h = (1.2)(30)h$ , which would make the scoop  $h_o = 0.111 \text{ m}$  high. However, we lose the near-wall mass flow  $\rho U \delta^*$ , so the proper scoop height is equal to

$$h = h_o + \delta^* = 0.111 \text{ m} + 0.0117 \text{ m} \approx \mathbf{0.123 \text{ m}} \quad \text{Ans. (a)}$$

(b) Assume  $\text{Re}_{tr} = 5\text{E}5$  and use Eq. (7.49a) to estimate the drag:

$$\text{Re}_x = 1.2\text{E}7, \quad C_d = \frac{0.031}{\text{Re}_x^{1/7}} - \frac{1440}{\text{Re}_x} = 0.00302 - 0.00012 = 0.00290$$

$$F_{drag} = C_d \frac{\rho}{2} V^2 b L = 0.0029 \left( \frac{1.2 \text{ kg/m}^3}{2} \right) (30 \text{ m/s})^2 (1 \text{ m})(6 \text{ m}) = \mathbf{9.4 \text{ N}} \quad \text{Ans. (b)}$$

**7.38** Atmospheric boundary layers are very thick but follow formulas very similar to those of flat-plate theory. Consider wind blowing at 10 m/s at a height of 80 m above a smooth beach. Estimate the wind shear stress, in Pa, on the beach if the air is standard sea-level conditions. What will the wind velocity striking your nose be if (a) you are standing up and your nose is 170 cm off the ground; (b) you are lying on the beach and your nose is 17 cm off the ground?



**Solution:** For air at 20°C, take  $\rho = 1.2 \text{ kg/m}^3$  and  $\mu = 1.8\text{E-}5 \text{ kg/m}\cdot\text{s}$ . Assume a *smooth* beach and use the log-law velocity profile, Eq. (7.34), given  $u = 10 \text{ m/s}$  at  $y = 80 \text{ m}$ :

$$\frac{u}{u^*} = \frac{10 \text{ m/s}}{u^*} \approx \frac{1}{\kappa} \ln\left(\frac{yu^*}{\nu}\right) + B = \frac{1}{0.41} \ln\left(\frac{80u^*}{1.5\text{E-}5}\right) + 5.0, \quad \text{solve } u^* \approx 0.254 \text{ m/s}$$

$$\text{Hence } \tau_{\text{surface}} = \rho u^{*2} = (1.2)(0.254)^2 \approx \mathbf{0.0772 \text{ Pa}} \quad \text{Ans.}$$

The log-law should be valid as long as we stay above  $y$  such that  $yu^*/\nu > 50$ :

$$(a) \ y = 1.7 \text{ m}: \quad \frac{u}{0.254} \approx \frac{1}{0.41} \ln\left[\frac{1.7(0.254)}{1.5\text{E-}5}\right] + 5, \quad \text{solve } u_{1.7 \text{ m}} \approx \mathbf{7.6 \frac{m}{s}} \quad \text{Ans. (a)}$$

$$(b) \ y = 17 \text{ cm}: \quad \frac{u}{0.254} \approx \frac{1}{0.41} \ln\left[\frac{0.17(0.254)}{1.5\text{E-}5}\right] + 5, \quad \text{solve } u_{17 \text{ cm}} \approx \mathbf{6.2 \frac{m}{s}} \quad \text{Ans. (b)}$$

The (b) part seems very close to the surface, but  $yu^*/\nu \approx 2800 > 50$ , so the log-law is OK.

**7.39** A hydrofoil 50 cm long and 4 m wide moves at 28 kn in seawater at 20°C. Using flat-plate theory with  $Re_{tr} = 5E5$ , estimate its drag, in N, for (a) a smooth wall and (b) a rough wall,  $\varepsilon = 0.3 \text{ mm}$ .

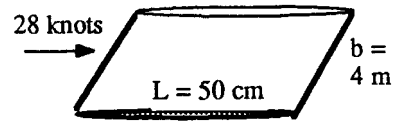


Fig. P7.39

**Solution:** For seawater at 20°C, take  $\rho = 1025 \text{ kg/m}^3$  and  $\mu = 0.00107 \text{ kg/m}\cdot\text{s}$ . Convert 28 knots = 14.4 m/s. Evaluate  $Re_L = (1025)(14.4)(0.5)/(0.00107) \approx 6.9E6$  (turbulent). Then

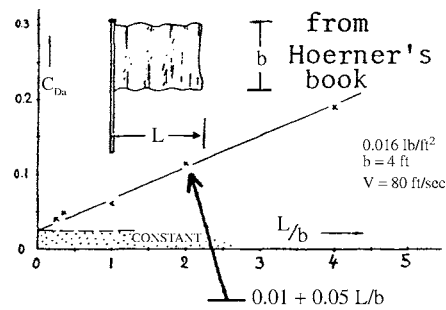
$$\text{Smooth, Eq. (7.49a): } C_D = \frac{0.031}{Re_L^{1/7}} - \frac{1440}{Re_L} \approx 0.00306$$

$$\text{Drag} = C_D \left(\frac{\rho}{2}\right) U^2 b L (2 \text{ sides}) = (0.00306) \left(\frac{1025}{2}\right) (14.4)^2 (4)(0.5)(2) \approx \mathbf{1300 \text{ N}} \quad \text{Ans. (a)}$$

$$\text{Rough, } \frac{L}{\varepsilon} = \frac{500}{0.3} = 1667, \quad \text{Fig. 7.6 or Eq. (7.48b): } C_D \approx 0.00742$$

$$\text{Drag} = (0.00742) \left(\frac{1025}{2}\right) (14.4)^2 (4)(0.5)(2 \text{ sides}) \approx \mathbf{3150 \text{ N}} \quad \text{Ans. (b)}$$

**7.40** Hoerner (Ref. 12) plots the drag of a flag in winds, based on total surface area  $2bL$ , in the figure at right. A linear approximation is  $C_D \approx 0.01 + 0.05L/b$ , as shown. Test Reynolds numbers were  $1E6$  or greater. (a) Explain why these values are greater than for a flat plate. (b) Assuming sea-level air at 50 mi/h, with area  $bL = 4 \text{ m}^2$ , find the proper flag dimensions for which the total drag is approximately 400 N.



**Fig. P7.40**

**Solution:** (a) The drag is greater because the fluttering of the flag causes additional *pressure drag* on the corrugated sections of the cloth. *Ans. (a)*

(b) For air take  $\rho = 1.225 \text{ kg/m}^3$  and  $\mu = 1.8E-5 \text{ kg/m}\cdot\text{s}$ . Convert  $U = 50 \text{ mi/h} = 22.35 \text{ m/s}$ . Evaluate the drag force from the force coefficient:

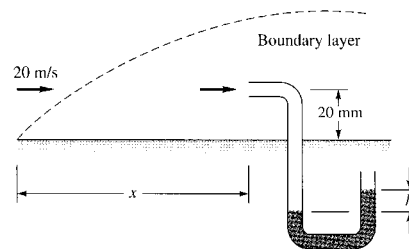
$$F = C_D \frac{\rho}{2} U^2 A = \left( 0.01 + 0.05 \frac{L}{b} \right) \left( \frac{1.225}{2} \right) (22.35)^2 (2 \times 4.0 \text{ m}^2) = 400 \text{ N}$$

$$\text{Solve for } C_D = 0.163 \text{ or } L/b \approx 3.07$$

Combine this with the fact that  $bL = 4 \text{ m}^2$  and we obtain

$$L \approx \mathbf{3.51 \text{ m}} \text{ and } b \approx \mathbf{1.14 \text{ m}} \text{ } \textit{Ans. (b)}$$

**7.41** Repeat Prob. 7.20 with the sole change that the pitot probe is now 20 mm from the wall (10 times higher). Show that the flow there cannot possibly be laminar, and use smooth-wall turbulent-flow theory to estimate the position  $x$  of the probe, in m.



**Fig. P7.20**

**Solution:** For air at  $20^\circ\text{C}$ , take  $\rho = 1.2 \text{ kg/m}^3$  and  $\mu = 1.8E-5 \text{ kg/m}\cdot\text{s}$ . For  $U = 20 \text{ m/s}$ , it is *not possible* for a laminar boundary-layer to grow to a thickness of 20 mm. Even at the largest possible laminar Reynolds number of  $3E6$ , the laminar thickness is only

$$\text{Re}_x = 3E6 = \frac{1.2(20)x}{1.8E-5}, \text{ or } x = 2.25 \text{ m}, \quad \delta \approx \frac{5x}{\text{Re}_x^{1/2}} = \frac{5(2.25)}{(3E6)^{1/2}} \approx \mathbf{6.5 \text{ mm} < 20 \text{ mm!} \text{ } \textit{Ans.}}$$

Therefore the flow must be turbulent. Recall from Prob. 7.20 that the manometer reading was  $h = 16$  mm of Meriam red oil,  $SG = 0.827$ . Thus

$$\Delta p_{\text{mano}} = \Delta \rho g h = [0.827(998) - 1.2](9.81)(0.016) \approx 129 \text{ Pa}, \quad u_{\text{pitot}} = \sqrt{\frac{2\Delta p}{\rho}} \approx 14.7 \frac{\text{m}}{\text{s}}$$

Then, at  $y = 20$  mm,  $\frac{u}{U} = \frac{14.7}{20} \approx 0.734 \approx \left(\frac{y}{\delta}\right)^{1/7} = \left(\frac{20 \text{ mm}}{\delta}\right)^{1/7}$ , or  $\delta \approx 174$  mm

Thus, crudely,  $\delta/x = 0.174/x \approx 0.16/\text{Re}_x^{1/7}$ , solve for  $x \approx 11.6$  m. *Ans.*

**7.42** A four-bladed helicopter rotor rotates at  $n$  r/min in air with properties  $(\rho, \mu)$ . Each blade has chord length  $C$  and extends from the center of rotation out to radius  $R$  (the hub size is neglected). Assuming turbulent flow from the leading edge, develop an analytical estimate for the power  $P$  required to drive this rotor. (There is no forward velocity.)

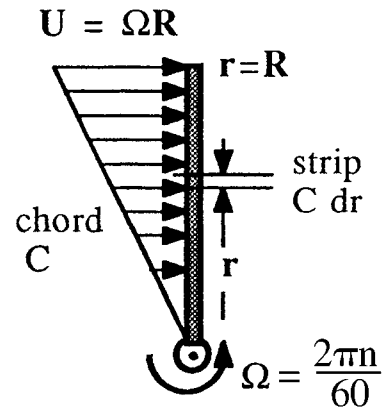


Fig. P7.42

**Solution:** The “freestream” velocity varies linearly from root to tip, as shown in the figure. Thus the drag force on a strip ( $C \, dr$ ) of blade is, for turbulent flow,

$$dF = \frac{0.031}{\text{Re}_C^{1/7}} \left(\frac{\rho}{2}\right) u^2 C \, dr \text{ (2 sides)} \approx 0.031 \mu^{1/7} \rho^{6/7} C^{6/7} (\Omega r)^{13/7} \, dr, \quad \text{where } u = \Omega r.$$

$$\text{or Power} = \int_{\text{blade}} u \, dF \text{ (4 blades)} = 4(0.031) \mu^{1/7} \rho^{6/7} C^{6/7} \Omega^{20/7} \int_0^R r^{20/7} \, dr$$

Finally, after cleaning up,  $P_{4 \text{ blades}} \approx 0.0321 \mu^{1/7} \rho^{6/7} C^{6/7} \Omega^{20/7} R^{27/7}$  *Ans.*

**7.43** In the flow of air at  $20^\circ\text{C}$  and 1 atm past a flat plate in Fig. P7.43, the wall shear is to be determined at position  $x$  by a *floating element* (a small area connected to a strain-gage force measurement). At  $x = 2$  m, the element indicates a shear stress of 2.1 Pa. Assuming turbulent flow from the

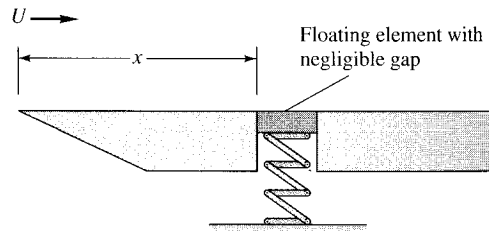


Fig. P7.43

leading edge, estimate (a) the stream velocity  $U$ , (b) the boundary layer thickness  $\delta$  at the element, and (c) the boundary-layer velocity  $u$ , in m/s, at 5 cm above the element.

**Solution:** For air at 20°C, take  $\rho = 1.2 \text{ kg/m}^3$  and  $\mu = 1.8\text{E-}5 \text{ kg/m}\cdot\text{s}$ . The shear stress is

$$\tau_w = 2.1 \text{ Pa} = C_f \frac{\rho}{2} U^2 = \frac{0.027}{(\rho U x / \mu)^{1/7}} \left( \frac{\rho U^2}{2} \right) = \frac{0.027}{[1.2U(2)/1.8\text{E-}5]^{1/7}} \left( \frac{1.2U^2}{2} \right)$$

Solve for  $U \approx \mathbf{34 \frac{m}{s}}$  Ans. (a) Check  $Re_x \approx 4.54\text{E}6$  (OK, turbulent)

With the local Reynolds number known, solve for local thickness:

$$\delta \approx \frac{0.16x}{Re_x^{1/7}} = \frac{0.16(2 \text{ m})}{(4.54\text{E}6)^{1/7}} \approx 0.036 \text{ m} \approx \mathbf{36 \text{ mm}}$$
 Ans. (b)

Normally, the log-law, Eq. (7.34), is probably best for estimating the velocity at  $y = 5 \text{ cm}$  above the element. However, from Ans. (b) just above, we see that this point is outside the boundary layer. Therefore, the velocity must be  $\mathbf{u = U \approx 34 \text{ m/s}}$ . Ans. (c).

[NOTE: Part (c) was supposed to state  $y = 5 \text{ mm}$ , in which case the correct answer would have been  $u \approx 26.5 \text{ m/s}$ .]

**7.44** Extensive measurements of wall shear stress and local velocity for turbulent airflow on the flat surface of the University of Rhode Island wind tunnel have led to the following proposed correlation:

$$\frac{\rho y^2 \tau_w}{\mu^2} \approx 0.0207 \left( \frac{uy}{\nu} \right)^{1.77}$$

Thus, if  $y$  and  $u(y)$  are known at a point in a flat-plate boundary layer, the wall shear may be computed directly. If the answer to part (c) of Prob. 7.43 is  $u \approx 27 \text{ m/s}$ , determine whether the correlation is accurate for this case.

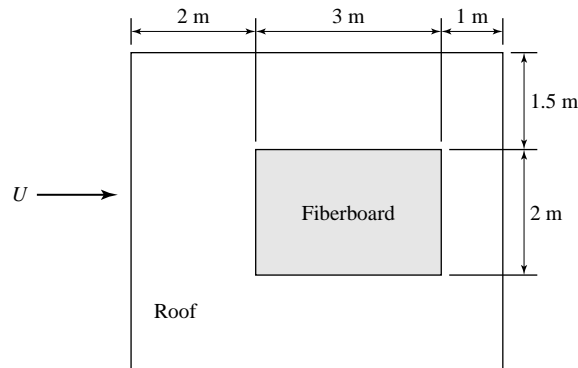
**Solution:** For air at 20°C, take  $\rho = 1.2 \text{ kg/m}^3$  and  $\mu = 1.8\text{E-}5 \text{ kg/m}\cdot\text{s}$ . The shear stress is given as 2.1 Pa, and part (c) was supposed to give  $y = 5 \text{ mm}$ . Check each side of the proposed correlation:

$$\frac{\rho y^2 \tau_w}{\mu^2} = \frac{1.2(0.005)^2(2.1)}{(1.8\text{E-}5)^2} \approx 194000;$$

$$0.0207 \left( \frac{uy}{\nu} \right)^{1.77} = 0.0207 \left[ \frac{27(0.005)}{1.5\text{E-}5} \right]^{1.77} \approx 207000 \quad (6\% \text{ more})$$

The **correlation is good** and would be even better using a more exact  $u_{\text{part(c)}} \approx 26.5 \text{ m/s}$ .

**7.45** A thin sheet of fiberboard weighs 90 N and lies on a rooftop, as shown in the figure. Assume ambient air at 20°C and 1 atm. If the coefficient of solid friction between board and roof is  $\sigma = 0.12$ , what wind velocity will generate enough friction to dislodge the board?



**Fig. P7.45**

**Solution:** For air take  $\rho = 1.2 \text{ kg/m}^3$  and  $\mu = 1.8\text{E-}5 \text{ kg/m}\cdot\text{s}$ . Our first problem is to evaluate the drag when the leading edge is *not* at  $x = 0$ . Since the dimensions are large, we will assume that the flow is *turbulent* and check this later:

$$F = \int_{x_1}^{x_2} \tau_w dA = \int_{x_1}^{x_2} \left[ \frac{0.027(\rho/2)U^2}{(\rho U x / \mu)^{1/7}} \right] b dx = \left( \frac{0.031b\rho U^2}{2} \right) \left( \frac{\mu}{\rho U} \right)^{1/7} (x_2^{6/7} - x_1^{6/7})$$

Set this equal to the dislodging friction force  $F = \sigma W = 0.12(90) = 10.8 \text{ N}$ :

$$\frac{0.031}{2} (1.2)(2.0)U^2 \left( \frac{1.8\text{E-}5}{1.2U} \right)^{1/7} (5.0^{6/7} - 2.0^{6/7}) = 10.8 \text{ N}$$

Solve this for  $U = 33 \text{ m/s} \approx 73 \text{ mi/h}$  *Ans.*

$$\text{Re}_{x_1} = 4.4\text{E}6: \text{turbulent, OK.}$$

**7.46** A ship is 150 m long and has a wetted area of 5000 m<sup>2</sup>. If it is encrusted with barnacles, the ship requires 7000 hp to overcome friction drag when moving in seawater at 15 kn and 20°C. What is the average roughness of the barnacles? How fast would the ship move with the same power if the surface were smooth? Neglect wave drag.

**Solution:** For seawater at 20°C, take  $\rho = 1025 \text{ kg/m}^3$  and  $\mu = 0.00107 \text{ kg/m}\cdot\text{s}$ . Convert 15 kn = 7.72 m/s. Evaluate  $\text{Re}_L = (1025)(7.72)(150)/(0.00107) \approx 1.11\text{E}9$  (turbulent). Then

$$F = \frac{\text{Power}}{U} = \frac{5.22\text{E}6 \text{ W}}{7.72} = 6.76\text{E}5 \text{ N}, \quad C_D = \frac{2F}{\rho U^2 A} = \frac{2(6.76\text{E}5)}{1025(7.72)^2(5000)} \approx 0.00443$$

Fig. 7.6 or Eq. (7.48b):

$$\frac{L}{\varepsilon} \approx 16800, \quad \varepsilon_{\text{barnacles}} = \frac{150}{16800} \approx \mathbf{0.0089 \text{ m}} \quad \text{Ans. (a)}$$

If the surface were smooth, we could use Eq. (7.45) to predict a higher ship speed:

$$P = FU = \left[ C_D \frac{\rho U^2}{2} A \right] U = \left\{ \frac{0.031}{[1025U(150)/.00107]^{1/7}} \right\} \left( \frac{1025}{2} \right) U^2 (5000)U,$$

or:  $P = 5.22\text{E}6 \text{ watts} = 5428U^{20/7}$ , solve for  $U = 11.1 \text{ m/s} \approx \mathbf{22 \text{ knots}}$  Ans. (b)

---

**7.47** As a case similar to Example 7.5, Howarth also proposed the adverse-gradient velocity distribution  $U = U_o(1 - x^2/L^2)$  and computed separation at  $x_{\text{sep}}/L = 0.271$  by a series-expansion method. Compute separation by Thwaites' method and compare.

**Solution:** Introduce this freestream velocity into Eq. (7.54), with  $\theta_o = 0$ , and integrate:

$$\theta^2 \approx \frac{0.45\nu}{U_o^6(1-x^2/L^2)^6} \int_0^x U_o^5(1-x^2/L^2)^5 dx,$$

$$\text{or: } \lambda = \frac{\theta^2}{\nu} \frac{dU}{dx} = \frac{-0.9\eta}{(1-\eta^2)^6} \int_0^\eta (1-\eta^2)^5 d\eta, \quad \eta = \frac{x}{L}$$

The result is algebraically complicated but easily solved for the separation point:

$$\lambda = -0.9 \left( \eta^2 - \frac{5\eta^4}{3} + 2\eta^6 - \frac{10\eta^8}{7} + \frac{5\eta^{10}}{9} - \frac{\eta^{12}}{11} \right) (1-\eta^2)^{-6} = -0.090 \text{ at separation}$$

Solve for  $\eta_{\text{separation}} = 0.268$ , or:  $(\mathbf{x/L})_{\text{sep}} = \mathbf{0.268}$  (within 1%) Ans.

---

**7.48** In 1957 H. Görtler proposed the adverse-gradient test cases

$$U = \frac{U_o}{(1+x/L)^n}$$

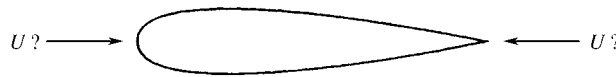
and computed separation for laminar flow at  $n = 1$  to be  $x_{\text{sep}}/L = 0.159$ . Compare with Thwaites' method, assuming  $\theta_o = 0$ .

**Solution:** Introduce this stream velocity ( $n = 1$ ) into Eq. (7.54), with  $\theta_0 = 0$ , and integrate:

$$\theta^2 = \frac{0.45\nu}{U_o^6} \left(1 + \frac{x}{L}\right)^6 \int_0^x U_o^5 \left(1 + \frac{x}{L}\right)^{-5} dx, \quad \text{or: } \lambda = \frac{\theta^2}{\nu} \frac{dU}{dx} = \frac{0.45}{4} \left[1 - \left(1 + \frac{x}{L}\right)^4\right]$$

$$\text{Separation: } \lambda = -0.09 \quad \text{if } \left(\frac{x}{L}\right)_{\text{sep}} \approx \mathbf{0.158} \quad (\leq 1\% \text{ error}) \quad \text{Ans.}$$

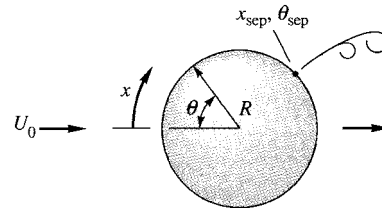
**7.49** Based on your understanding of boundary layers, which flow direction (left or right) for the foil shape in the figure will have *less* total drag?



**Fig. P7.49**

**Solution:** Flow to the left has a long run of mild favorable gradient and then a short run of *strong* adverse gradient—separation and a broad wake will occur, **high pressure drag**. Flow to the right has a long run of *mild* adverse gradient—less separation, **low pressure drag**.

**7.50** For flow past a cylinder of radius  $R$  as in Fig. P7.50, the theoretical inviscid velocity distribution along the surface is  $U = 2U_o \sin(x/R)$ , where  $U_o$  is the oncoming stream velocity and  $x$  is the arc length measured from the nose (Chap. 8). Compute the laminar separation point  $x_{\text{sep}}$  and  $\theta_{\text{sep}}$  by Thwaites' method, and compare with the digital-computer solution  $x_{\text{sep}}/R = 1.823$  ( $\theta_{\text{sep}} = 104.5^\circ$ ) given by R. M. Terrill in 1960.



**Fig. P7.50**

**Solution:** Introduce this freestream velocity into Eq. (7.54), with  $\theta_0 = 0$ , and integrate:

$$\theta^2 = \frac{0.45 G n}{(2U_o)^6 \sin^6(x/R)} \int_0^x (2U_o)^5 \sin^5(x/R) dx, \quad \text{with } \lambda = \frac{\theta^2}{\nu} \frac{dU}{dx}, \quad \frac{dU}{dx} = \frac{2U_o}{R} \cos(x/R)$$

$$\text{Result: } \lambda = \frac{0.03 \cos(x/R)}{\sin^6(x/R)} \left[ 8 - \cos\left(\frac{x}{R}\right) \left\{ 8 + 4 \sin^2\left(\frac{x}{R}\right) + 3 \sin^4\left(\frac{x}{R}\right) \right\} \right]$$

The integral can be found in a good Table of Integrals. Separation then occurs at:

$$\lambda = -0.09 \quad \text{at } (x/R)_{\text{sep}} \approx 1.7995, \quad \text{or} \quad \theta_{\text{sep}} = 1.7995 \left( \frac{180}{\pi} \right) \approx \mathbf{103.1^\circ} \quad \text{Ans.}$$

(1.4° less than Terrill's computation)

**7.51** Consider the flat-walled diffuser in Fig. P7.51, which is similar to that of Fig. 6.26a with constant width  $b$ . If  $x$  is measured from the inlet and the wall boundary layers are thin, show that the core velocity  $U(x)$  in the diffuser is given approximately by

$$U = \frac{U_o}{1 + (2x \tan \theta)/W}$$

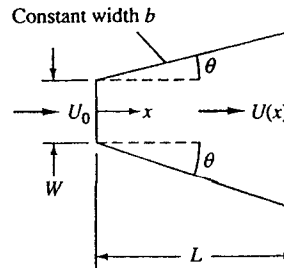


Fig. P7.51

where  $W$  is the inlet height. Use this velocity distribution with Thwaites' method to compute the wall angle  $\theta$  for which laminar separation will occur in the exit plane when diffuser length  $L = 2W$ . Note that the result is independent of the Reynolds number.

**Solution:** We can approximate  $U(x)$  by the one-dimensional continuity relation:

$$U_o W b = U(W + 2x \tan \theta) b, \quad \text{or:} \quad U(x) \approx U_o / [1 + 2x \tan \theta / W] \quad (\text{same as G\"ortler, Prob. 7.38})$$

We return to the solution from G\"ortler's ( $n = 1$ ) distribution in Prob. 7.38:

$$\lambda = -0.09 \quad \text{if} \quad \frac{2x \tan \theta}{W} = 0.158 \quad (\text{separation}), \quad \text{or} \quad x = L = 2W,$$

$$\tan \theta_{\text{sep}} = \frac{0.158}{4} = 0.0396, \quad \theta_{\text{sep}} \approx \mathbf{2.3^\circ} \quad \text{Ans.}$$

[This laminar result is much less than the turbulent value  $\theta_{\text{sep}} \approx 8^\circ - 10^\circ$  in Fig. 6.26c.]

**7.52** Clift et al. [46] give the formula  $F \approx (6\pi/5)(4 + a/b)\mu U b$  for the drag of a prolate spheroid in *creeping motion*, as shown in Fig. P7.52. The half-thickness  $b$  is 4 mm. See also [49]. If the fluid is SAE 50W oil at 20°C, (a) check that  $Re_b < 1$ ; and (b) estimate the spheroid length if the drag is 0.02 N.



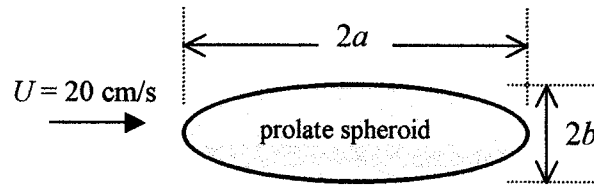


Fig. P7.52

**Solution:** For SAE 50W oil, take  $\rho = 902 \text{ kg/m}^3$  and  $\mu = 0.86 \text{ kg/m}\cdot\text{s}$ . (a) The Reynolds number based on half-thickness is:

$$\text{Re}_b = \frac{\rho U b}{\mu} = \frac{(902 \text{ kg/m}^3)(0.2 \text{ m/s})(0.004 \text{ m})}{0.86 \text{ kg/m}\cdot\text{s}} = \mathbf{0.84} < 1 \quad \text{Ans. (a)}$$

(b) With a given force and creeping-flow force formula, we can solve for the half-length  $a$ :

$$F = 0.02 \text{ N} = \frac{6\pi}{5} \left(4 + \frac{a}{b}\right) \mu U b = \frac{6\pi}{5} \left(4 + \frac{a}{0.004}\right) (0.86 \text{ kg/m}\cdot\text{s})(0.20 \text{ m/s})(0.004 \text{ m})$$

$$\text{Solve for } a = 0.0148 \text{ m, } \mathbf{\textit{Spheroid length} = 2a = 0.030 \text{ m}} \quad \text{Ans. (b)}$$

**7.53** From Table 7.2, the drag coefficient of a wide plate normal to a stream is approximately 2.0. Let the stream conditions be  $U_\infty$  and  $p_\infty$ . If the average pressure on the front of the plate is approximately equal to the free-stream stagnation pressure, what is the average pressure on the rear?

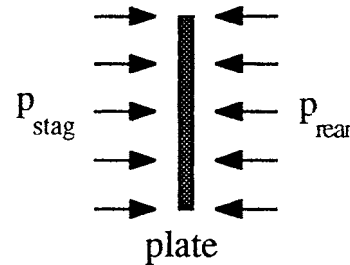


Fig. P7.53

**Solution:** If the drag coefficient is 2.0, then our approximation is

$$F_{\text{drag}} = 2.0 \frac{\rho}{2} U_\infty^2 A_{\text{plate}} \stackrel{?}{\approx} (p_{\text{stag}} - p_{\text{rear}}) A_{\text{plate}}, \quad \text{or: } p_{\text{rear}} \approx p_{\text{stag}} - \rho U_\infty^2$$

$$\text{Since, from Bernoulli, } p_{\text{stag}} = p_\infty + \frac{\rho}{2} U_\infty^2, \quad \text{we obtain } \mathbf{p_{\text{rear}} \approx p_\infty - \frac{\rho}{2} U_\infty^2} \quad \text{Ans.}$$

**7.54** A chimney at sea level is 2 m in diameter and 40 m high and is subjected to 50 mi/h storm winds. What is the estimated wind-induced bending moment about the bottom of the chimney?

**Solution:** For sea-level air, take  $\rho = 1.225 \text{ kg/m}^3$  and  $\mu = 1.78\text{E-}5 \text{ kg/m}\cdot\text{s}$ . Convert  $50 \text{ mi/h} = 22.35 \text{ m/s}$ . Evaluate the Reynolds number and drag coefficient for a cylinder:

$$\text{Re}_D = \frac{\rho U D}{\mu} = \frac{1.225(22.35)(2)}{1.78\text{E-}5} \approx 3.08\text{E}6 \text{ (turbulent); Fig. 7.16a: } C_D \approx 0.4 \pm 0.1$$

$$\text{Then } F_{\text{drag}} = C_D \frac{\rho}{2} U^2 D L = 0.4 \left( \frac{1.225}{2} \right) (22.35)^2 (2)(40) \approx \mathbf{10,000 \text{ N}} \quad \text{Ans. (a)}$$

$$\text{Root bending moment } M_o \approx FL/2 = (10000)(40/2) \approx \mathbf{200,000 \text{ N}\cdot\text{m}} \quad \text{Ans. (b)}$$

**7.55** A ship tows a submerged cylinder, 1.5 m in diameter and 22 m long, at  $U = 5 \text{ m/s}$  in fresh water at  $20^\circ\text{C}$ . Estimate the towing power in kW if the cylinder is (a) parallel, and (b) normal to the tow direction.

**Solution:** For water at  $20^\circ\text{C}$ , take  $\rho = 998 \text{ kg/m}^3$  and  $\mu = 0.001 \text{ kg/m}\cdot\text{s}$ .

$$\text{(a) Parallel, } \frac{L}{D} \approx 15, \quad \text{Re}_L = \frac{998(5)(22)}{0.001} = 1.1\text{E}8, \quad \text{Table 7.3: estimate } C_{D,\text{frontal}} \approx 1.1$$

$$F = 1.1 \left( \frac{998}{2} \right) (5)^2 \left( \frac{\pi}{4} \right) (1.5)^2 \approx 24000 \text{ N}, \quad \text{Power} = FU \approx \mathbf{120 \text{ kW}} \quad \text{Ans. (a)}$$

$$\text{(b) Normal, } \text{Re}_D = \frac{998(5)(1.5)}{0.001} = 7.5\text{E}6, \quad \text{Fig. 7.16a: } C_{D,\text{frontal}} \approx 0.4$$

$$F = 0.4 \left( \frac{998}{2} \right) (5)^2 (1.5)(22) \approx 165000 \text{ N}, \quad \text{Power} = FU \approx \mathbf{800 \text{ kW}} \quad \text{Ans. (b)}$$

**7.56** A delivery vehicle carries a long sign on top, as in Fig. P7.56. If the sign is very thin and the vehicle moves at  $65 \text{ mi/h}$ , (a) estimate the force on the sign with no crosswind. (b) Discuss the effect of a crosswind.

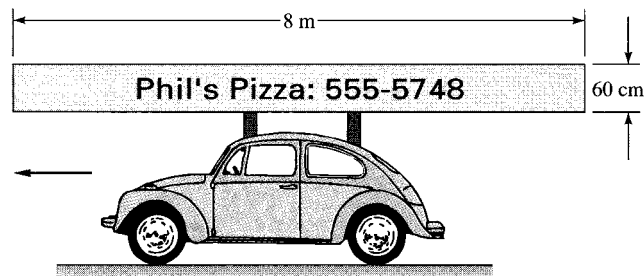


Fig. P7.56

**Solution:** For air at 20°C, take  $\rho = 1.2 \text{ kg/m}^3$  and  $\mu = 1.8\text{E-}5 \text{ kg/m}\cdot\text{s}$ . Convert 65 mi/h = 29.06 m/s. (a) If there is no crosswind, we may estimate the drag force by flat-plate theory:

$$\text{Re}_L = \frac{1.2(29.06)(8)}{1.8\text{E-}5} = 1.55\text{E}7 \text{ (turbulent)}, \quad C_D = \frac{0.031}{\text{Re}_L^{1/7}} = \frac{0.031}{(1.55\text{E}7)^{1/7}} \approx 0.00291$$

$$F_{\text{drag}} = C_D \left( \frac{\rho}{2} \right) V^2 bL (2 \text{ sides}) = 0.00291 \left( \frac{1.2}{2} \right) (29.06)^2 (0.6)(8)(2 \text{ sides}) = 14 \text{ N} \quad \text{Ans. (a)}$$

(b) A crosswind will cause a large side force on the sign, greater than the flat-plate drag. The sign will act like an airfoil. For example, if the 29 m/s wind is at an angle of only 5° with respect to the sign, from Eq. (7.70),  $C_L \approx 2\pi \sin(5^\circ)/(1 + 2/.075) \approx 0.02$ . The lift on the sign is then about

$$\text{Lift} = C_L (\rho/2) V^2 bL \approx (0.02)(1.2/2)(29.06)^2(0.6)(8) \approx 50 \text{ N} \quad \text{Ans. (b)}$$

**7.57** The main cross-cable between towers of a coastal suspension bridge is 60 cm in diameter and 90 m long. Estimate the total drag force on this cable in crosswinds of 50 mi/h. Are these laminar-flow conditions?

**Solution:** For air at 20°C, take  $\rho = 1.2 \text{ kg/m}^3$  and  $\mu = 1.8\text{E-}5 \text{ kg/m}\cdot\text{s}$ . Convert 50 mi/h = 22.35 m/s. Check the Reynolds number of the cable:

$$\text{Re}_D = \frac{1.2(22.35)(0.6)}{1.8\text{E-}5} \approx 894000 \text{ (turbulent flow)} \quad \text{Fig. 7.16a: } C_D \approx 0.3$$

$$F_{\text{drag}} = C_D \frac{\rho}{2} U^2 DL = 0.3 \left( \frac{1.2}{2} \right) (22.35)^2 (0.6)(90) \approx 5000 \text{ N (not laminar)} \quad \text{Ans.}$$

**7.58** A long cylinder of rectangular cross section, 5 cm high and 30 cm long, is immersed in water at 20°C flowing at 12 m/s parallel to the long side of the rectangle. Estimate the drag force on the cylinder, per unit length, if the rectangle (a) has a flat face or (b) has a rounded nose.

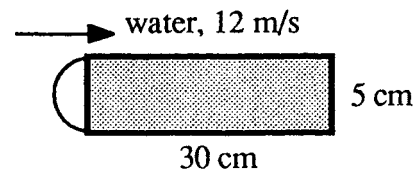


Fig. P7.58

**Solution:** For water at 20°C, take  $\rho = 998 \text{ kg/m}^3$  and  $\mu = 0.001 \text{ kg/m}\cdot\text{s}$ . Assume a two-dimensional flow, i.e., use Table 7.2. If the nose is *flat*,  $L/H = 6$ , then  $C_D \approx 0.9$ :

$$\text{Flat nose: } F = C_D \frac{\rho}{2} U^2 H (1 \text{ m}) = 0.9 \left( \frac{998}{2} \right) (12)^2 (0.05) \approx \mathbf{3200} \frac{\text{N}}{\text{m}} \quad \text{Ans. (a)}$$

$$\text{Round nose, Table 7.2: } C_D \approx 0.64, \quad F = \frac{0.64}{0.9} F_{\text{flat}} \approx \mathbf{2300} \frac{\text{N}}{\text{m}} \quad \text{Ans. (b)}$$

**7.59** Joe can pedal his bike at 10 m/s on a straight, level road with no wind. The bike rolling resistance is 0.80 N/(m/s), i.e. 0.8 N per m/s of speed. The drag area  $C_D A$  of Joe and his bike is 0.422 m<sup>2</sup>. Joe's mass is 80 kg and the bike mass is 15 kg. He now encounters a head wind of 5.0 m/s. (a) Develop an equation for the speed at which Joe can pedal into the wind. (*Hint:* A cubic equation.) (b) Solve for  $V$  for this head wind. (c) Why is the result not simply  $V = 10 - 5 = 5 \text{ m/s}$ , as one might first suspect?

**Solution:** Evaluate force and power with the drag based on *relative* velocity  $V + V_{\text{wind}}$ :

$$\sum F = F_{\text{rolling}} + F_{\text{drag}} = C_{RR} V + C_D A \frac{\rho}{2} (V + V_{\text{wind}})^2$$

$$\text{Power} = V \sum F = C_{RR} V^2 + C_D A \frac{\rho}{2} V (V + V_{\text{wind}})^2$$

Let  $V_{\text{nw}}$  (=10 m/s) be the bike speed with no wind and denote  $V_{\text{rel}} = V + V_{\text{wind}}$ . Joe's power output will be the same with or without the headwind:

$$P_{\text{nw}} = C_{RR} V_{\text{nw}}^2 + C_D A \frac{\rho}{2} V_{\text{nw}}^3 = P = C_{RR} V^2 + C_D A \frac{\rho}{2} V V_{\text{rel}}^2,$$

$$\text{or: } V^3 + \left( 2V_w + \frac{2C_{RR}}{\rho C_D A} \right) V^2 + (V_w^2) V - \left( V_{\text{nw}}^3 + \frac{2C_{RR}}{\rho C_D A} V_{\text{nw}}^2 \right) = 0 \quad \text{Ans. (a)}$$

For our given numbers, assuming  $\rho_{\text{air}} = 1.2 \text{ kg/m}^3$ , the result is the cubic equation

$$V^3 + 13.16V^2 + 25V - 1316 = 0, \quad \text{solve for } \mathbf{V \approx 7.4} \frac{\text{m}}{\text{s}} \quad \text{Ans. (b)}$$

Since drag is proportional to  $V_{\text{rel}}^2$ , a linear transformation  $V = V_{\text{nw}} - V_{\text{wind}}$  is *not* possible. Even if there were no rolling resistance,  $V \approx 7.0 \text{ m/s}$ , not 5.0 m/s. *Ans. (c)*

**7.60** A fishnet consists of 1-mm-diameter strings overlapped and knotted to form 1- by 1-cm squares. Estimate the drag of 1 m<sup>2</sup> of such a net when towed normal to its plane at 3 m/s in 20°C seawater. What horsepower is required to tow 400 ft<sup>2</sup> of this net?

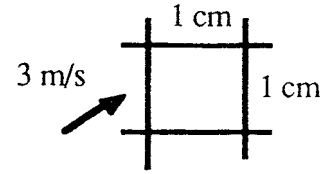


Fig. P7.60

**Solution:** For seawater at 20°C, take  $\rho = 1025 \text{ kg/m}^3$  and  $\mu = 0.00107 \text{ kg/m}\cdot\text{s}$ . Neglect the *knots* at the net's intersections. Estimate the drag of a single one-centimeter strand:

$$\text{Re}_D = \frac{1025(3)(0.001)}{0.00107} \approx 2900; \quad \text{Fig. 7.16a or Fig. 5.3a: } C_D \approx 1.0$$

$$F_{\text{one strand}} = C_D \frac{\rho}{2} U^2 DL = (1.0) \left( \frac{1025}{2} \right) (3)^2 (0.001)(0.01) \approx 0.046 \text{ N/strand}$$

$$\text{one m}^2 \text{ contains } 20,000 \text{ strands: } F_{1 \text{ sq m}} \approx 20000(0.046) \approx \mathbf{920 \text{ N}} \quad \text{Ans. (a)}$$

$$\text{To tow } 400 \text{ ft}^2 = 37.2 \text{ m}^2 \text{ of net, } F = 37.2(920) \approx 34000 \text{ N} \approx 7700 \text{ lbf}$$

$$\text{If } U = 3 \frac{\text{m}}{\text{s}} = 9.84 \frac{\text{ft}}{\text{s}}, \quad \text{Tow Power} = FU = (7700)(9.84) \div 550 \approx \mathbf{140 \text{ hp}} \quad \text{Ans. (b)}$$

**7.61** A filter may be idealized as an array of cylindrical fibers normal to the flow, as in Fig. P7.61. Assuming that the fibers are uniformly distributed and have drag coefficients given by Fig. 7.16a, derive an approximate expression for the pressure drop  $\Delta p$  through a filter of thickness  $L$ .

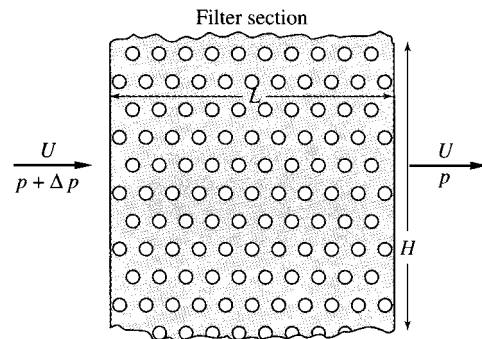


Fig. P7.61

**Solution:** Consider a filter section of height  $H$  and width  $b$  and thickness  $L$ . Let  $N$  be the number of fibers of diameter  $D$  per unit area  $HL$  of filter. Then the drag of all these filters must be balanced by a pressure  $\Delta p$  across the filter:

$$\Delta p H b = \sum F_{\text{fibers}} = N H L C_D \frac{\rho}{2} U^2 D b, \quad \text{or: } \Delta p_{\text{filter}} \approx \mathbf{N L C_D \frac{\rho}{2} U^2 D} \quad \text{Ans.}$$

This simple expression does not account for the *blockage* of the filters, that is, in cylinder arrays one must increase “ $U$ ” by  $1/(1 - \sigma)$ , where  $\sigma$  is the solidity ratio of the filter.

**7.62** A sea-level smokestack is 52 m high and has a *square* cross-section. Its supports can withstand a maximum side force of 90 kN. If the stack is to survive 90 mi/h hurricane winds, what is its maximum possible (square) width?

**Solution:** For sea-level air, take  $\rho = 1.225 \text{ kg/m}^3$  and  $\mu = 1.78\text{E-}5 \text{ kg/m}\cdot\text{s}$ . Convert 90 mi/h = 40.2 m/s. We cannot compute Re without knowing the side length  $a$ , so we assume that  $\text{Re} > 1\text{E}4$  and that Table 7.2 is valid. The worst case drag is when the square cylinder has its *flat* face forward,  $C_D \approx 2.1$ . Then the drag force is

$$F = C_D \frac{\rho}{2} U^2 a L = 2.1 \left( \frac{1.225}{2} \right) (40.2)^2 a (52) \stackrel{?}{=} 90000 \text{ N, solve } a \approx \mathbf{0.83 \text{ m}} \quad \text{Ans.}$$

$$\text{Check } \text{Re}_a = (1.225)(40.2)(0.83)/(1.78\text{E-}5) \approx 2.3\text{E}6 > 1\text{E}4, \text{ OK.}$$

**7.63** For those who think electric cars are sissy, Keio University in Japan has tested a 22-ft long prototype whose eight electric motors generate a total of 590 horsepower. The “Kaz” cruises at 180 mi/h (see *Popular Science*, August 2001, p. 15). If the drag coefficient is 0.35 and the frontal area is 26 ft<sup>2</sup>, what percent of this power is expended against sea-level air drag?

**Solution:** For air, take  $\rho = 0.00237 \text{ slug/ft}^3$ . Convert 180 mi/h to 264 ft/s. The drag is

$$F = C_D \frac{\rho}{2} V^2 A_{\text{frontal}} = (0.35) \left( \frac{0.00237 \text{ slug/ft}^3}{2} \right) (264 \text{ ft/s})^2 (26 \text{ ft}^2) = 752 \text{ lbf}$$

$$\text{Power} = FV = (752 \text{ lbf})(264 \text{ ft/s})/(550 \text{ ft}\cdot\text{lbf/hp}) = \mathbf{361 \text{ hp}}$$

The horsepower to overcome drag is **61% of the total 590** horsepower available. *Ans.*

**7.64** A parachutist jumps from a plane, using an 8.5-m-diameter chute in the standard atmosphere. The total mass of chutist and chute is 90 kg. Assuming a fully open chute in quasisteady motion, estimate the time to fall from 2000 to 1000 m.

**Solution:** For the standard altitude (Table A-6), read  $\rho = 1.112 \text{ kg/m}^3$  at 1000 m altitude and  $\rho = 1.0067 \text{ kg/m}^3$  at 2000 meters. Viscosity is not a factor in Table 7.3, where we read  $C_D \approx 1.2$  for a low-porosity chute. If acceleration is negligible,

$$W = C_D \frac{\rho}{2} U^2 \frac{\pi}{4} D^2, \quad \text{or: } 90(9.81) \text{ N} = 1.2 \left( \frac{\rho}{2} \right) U^2 \frac{\pi}{4} (8.5)^2, \quad \text{or: } U^2 = \frac{25.93}{\rho}$$

$$\text{Thus } U_{1000\text{ m}} = \sqrt{\frac{25.93}{1.1120}} = 4.83 \frac{\text{m}}{\text{s}} \quad \text{and} \quad U_{2000\text{ m}} = \sqrt{\frac{25.93}{1.0067}} = 5.08 \frac{\text{m}}{\text{s}}$$

Thus the change in velocity is very small (an average deceleration of only  $-0.001 \text{ m/s}^2$ ) so we can reasonably estimate the time-to-fall using the average fall velocity:

$$\Delta t_{\text{fall}} = \frac{\Delta z}{V_{\text{avg}}} = \frac{2000 - 1000}{(4.83 + 5.08)/2} \approx 202 \text{ s} \quad \text{Ans.}$$

**7.65** As soldiers get bigger and packs get heavier, a parachutist and load can weigh as much as 400 lbf. The standard 28-ft parachute may descend too fast for safety. For heavier loads, the U.S. Army Natick Center has developed a 28-ft, higher drag, less porous XT-11 parachute (see the URL <http://www.natick.army.mil>). This parachute has a sea-level descent speed of 16 ft/s with a 400-lbf load. (a) What is the drag coefficient of the XT-11? (b) How fast would the standard chute descend at sea-level with such a load?

**Solution:** For sea-level air, take  $\rho = 0.00237 \text{ slug/ft}^3$ . (a) Everything is known except  $C_D$ :

$$F = C_D \frac{\rho}{2} V^2 A = 400 \text{ lbf} = C_D \frac{0.00237 \text{ slug/ft}^3}{2} (16 \text{ ft/s})^2 \frac{\pi}{4} (28 \text{ ft})^2$$

$$\text{Solve for } C_{D,\text{new chute}} = 2.14 \quad \text{Ans. (a)}$$

(b) From Table 7.3, a standard chute has a drag coefficient of about 1.2. Then solve for  $V$ :

$$F = C_D \frac{\rho}{2} V^2 A = 400 \text{ lbf} = (1.2) \frac{0.00237 \text{ slug/ft}^3}{2} V^2 \frac{\pi}{4} (28 \text{ ft})^2$$

$$\text{Solve for } V_{\text{old chute}} = 21.4 \text{ ft/s} \quad \text{Ans. (b)}$$

**7.66** A sphere of density  $\rho_s$  and diameter  $D$  is dropped from rest in a fluid of density  $\rho$  and viscosity  $\mu$ . Assuming a constant drag coefficient  $C_{d_0}$ , derive a differential equation for the fall velocity  $V(t)$  and show that the solution is

$$V = \left[ \frac{4gD(S-1)}{3C_{d_0}} \right]^{1/2} \tanh Ct$$

$$C = \left[ \frac{3gC_{d_0}(S-1)}{4S^2D} \right]^{1/2}$$

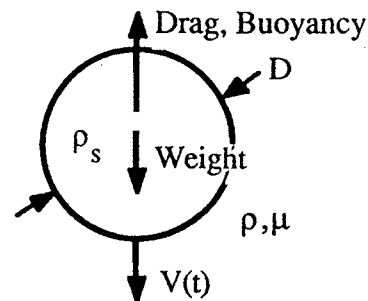


Fig. P7.66

where  $S = \rho_s/\rho$  is the specific gravity of the sphere material.

**Solution:** Newton's law for downward motion gives

$$\Sigma F_{\text{down}} = ma_{\text{down}}, \quad \text{or: } W - B - C_D \frac{\rho}{2} V^2 A = \frac{W}{g} \frac{dV}{dt}, \quad \text{where } A = \frac{\pi}{4} D^2$$

$$\text{and } W - B = \rho(S-1)g \frac{\pi}{6} D^3. \quad \text{Rearrange to } \frac{dV}{dt} = \beta - \alpha V^2,$$

$$\beta = g \left(1 - \frac{1}{S}\right) \quad \text{and} \quad \alpha = \frac{\rho g C_D A}{2W}$$

Separate the variables and integrate from rest,  $V = 0$  at  $t = 0$ :  $\int dt = \int dV/(\beta - \alpha V^2)$ ,

$$\text{or: } V = \sqrt{\frac{\beta}{\alpha}} \tanh(t\sqrt{\alpha\beta}) = V_{\text{final}} \tanh(Ct) \quad \text{Ans.}$$

$$\text{where } V_{\text{final}} = \left[ \frac{4gD(S-1)}{3C_D} \right]^{1/2} \quad \text{and} \quad C = \left[ \frac{3gC_D(S-1)}{4S^2D} \right]^{1/2}, \quad S = \frac{\rho_s}{\rho} > 1$$

**7.67** A world-class bicycle rider can generate one-half horsepower for long periods. If racing at sea-level, estimate the velocity which this cyclist can maintain. Neglect rolling friction.

**Solution:** For sea-level air, take  $\rho = 1.22 \text{ kg/m}^3$ . From Table 7.3 for a bicycle with a rider in the racing position,  $C_D A \approx 0.30 \text{ m}^2$ . With power known, we can solve for speed:

$$\text{Power} = FV = \left( C_D A \frac{\rho}{2} V^2 \right) V = 0.5 \text{ hp} = 373 \text{ W} = (0.3 \text{ m}^2) \frac{1.22 \text{ kg/m}^3}{2} V^3$$

$$\text{Solve for } V = \mathbf{12.7 \text{ m/s (about 28 mi/h)}} \quad \text{Ans.}$$

**7.68** A baseball weighs 145 g and is 7.35 cm in diameter. It is dropped from rest from a 35-m-high tower at approximately sea level. Assuming a laminar-flow drag coefficient, estimate (a) its terminal velocity and (b) whether it will reach 99 percent of its terminal velocity before it hits the ground.



**Solution:** For sea-level air, take  $\rho = 1.225 \text{ kg/m}^3$  and  $\mu = 1.78\text{E-}5 \text{ kg/m}\cdot\text{s}$ . Assume a laminar drag coefficient  $C_D \approx 0.47$  from Table 7.3. The terminal velocity is

$$V_{\text{final}} = \sqrt{\frac{2W}{C_D \rho (\pi/4) D^2}} = \sqrt{\frac{2[0.145(9.81)]}{0.47(1.225)(\pi/4)(0.0735)^2}} \approx \mathbf{34.1 \frac{m}{s}} \quad \text{Ans. (a)}$$

Now establish the “specific gravity” of the ball, relative to air:

$$\rho_{\text{ball}} = \frac{m}{v} = \frac{0.145}{(\pi/6)(0.0735)^3} = 697.4 \frac{\text{kg}}{\text{m}^3}, \quad \text{“S”} = \frac{\rho_{\text{ball}}}{\rho_{\text{air}}} = \frac{697.4}{1.225} = \mathbf{569}$$

Then the constant C from Prob. 7.66 gives the time history of velocity and displacement:

$$C = \left[ \frac{3gC_D(S-1)}{4S^2D} \right]^{1/2} = \left[ \frac{3(9.81)(0.47)(569-1)}{4(569)^2(0.0735)} \right]^{1/2} \approx 0.287 \text{ s}^{-1}, \quad V = V_f \tanh(Ct),$$

$$\text{or: } V = 34.1 \tanh(0.287t), \quad Z = \int V dt = \frac{34.1}{0.287} \ln[\cosh(0.287t)]$$

$$\text{Check } \text{Re}_D(\text{max}) = 1.225(34.1)(0.0735)/(1.78\text{E-}5) \approx 172000 \quad (\text{OK}, C_D \approx 0.47)$$

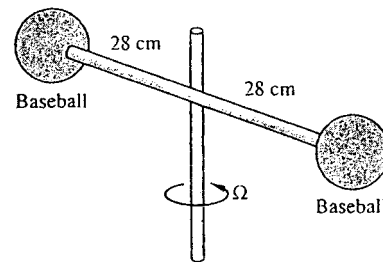
We can now find the time and velocity when the balls hits  $Z = 35 \text{ m}$ :

$$Z = 35 = \frac{34.1}{0.287} \ln[\cosh(0.287t)], \quad \text{solve for } t \approx \mathbf{2.81 \text{ s}}, \quad \text{whence}$$

$$V(\text{at } Z = 35 \text{ m}) = 34.1 \tanh[0.287(2.81)] \approx \mathbf{22.8 \frac{m}{s}} \quad \text{Ans. (b)}$$

This is only **67%** of terminal velocity. If we try the formulas again for  $V = 99\%$  of terminal velocity (about  $33.8 \text{ m/s}$ ), we find that  $t \approx 9.22 \text{ s}$  and  $Z \approx 230 \text{ m}$ .

**7.69** Two baseballs from Prob. 7.68 are connected to a rod 7 mm in diameter and 56 cm long, as in Fig. P7.69. What power, in W, is required to keep the system spinning at 400 r/min? Include the drag of the rod, and assume sea-level standard air.



**Fig. P7.69**

**Solution:** For sea-level air, take  $\rho = 1.225 \text{ kg/m}^3$  and  $\mu = 1.78\text{E-}5 \text{ kg/m}\cdot\text{s}$ . Assume a laminar drag coefficient  $C_D \approx 0.47$  from Table 7.3. Convert  $\Omega = 400 \text{ rpm} \times 2\pi/60 = 41.9 \text{ rad/s}$ . Each ball moves at a centerline velocity

$$V_b = \Omega r_b = (41.9)(0.28 + 0.0735/2) \approx 13.3 \text{ m/s}$$

Check  $Re = 1.225(13.3)(0.0735)/(1.78\text{E-}5) \approx 67000$ ; Table 7.3:  $C_D \approx 0.47$

Then the drag force on each baseball is approximately

$$F_b = C_D \frac{\rho}{2} V_b^2 \frac{\pi}{4} D^2 = 0.47 \left( \frac{1.225}{2} \right) (13.3)^2 \frac{\pi}{4} (0.0735)^2 \approx 0.215 \text{ N}$$

Make a similar approximate estimate for the drag of each rod:

$$V_r = \Omega r_{\text{avg}} = 41.9(0.14) \approx 5.86 \frac{\text{m}}{\text{s}}, \quad Re = \frac{1.225(5.86)(0.007)}{1.78\text{E-}5} \approx 2800, \quad C_D \approx 1.2$$

$$F_{\text{rod}} \approx C_D \left( \frac{\rho}{2} \right) V_r^2 DL = 1.2 \left( \frac{1.225}{2} \right) (5.86)^2 (0.007)(0.28) \approx 0.0495 \text{ N}$$

Then, with two balls and two rods, the total driving power required is

$$P = 2F_b V_b + 2F_r V_r = 2(0.215)(13.3) + 2(0.0495)(5.86) = 5.71 + 0.58 \approx \mathbf{6.3 \text{ W}} \quad \text{Ans.}$$

**7.70** A baseball from Prob. 7.68 is batted upward during a game at an angle of  $45^\circ$  and an initial velocity of 98 mi/h. Neglect spin and lift. Estimate the horizontal distance traveled, (a) neglecting drag and (b) accounting for drag in a numerical (computer) solution with a transition Reynolds number  $Re_{D,\text{crit}} = 2.5\text{E}5$ .

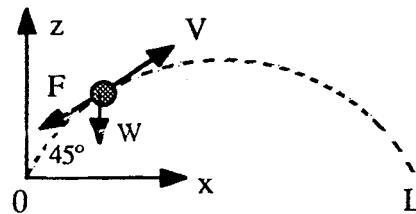


Fig. P7.70

**Solution:** (a) Convert  $98 \text{ mi/h} = 43.8 \text{ m/s}$ . For zero drag, we make use of the simple physics formulas for particles:

$$\Delta x_{\text{max}} = L = \frac{2V_{\text{XD}}^2}{g} = \frac{2(V_o \cos 45^\circ)^2}{g} = \frac{V_o^2}{g} = \frac{(43.8)^2}{9.81} = 196 \text{ m} = \mathbf{642 \text{ ft}} \quad \text{Ans. (a)}$$

(b) With drag of a sphere ( $C_D \approx 0.47$ ) included, we need to use Newton's law in both the  $x$ - and  $z$ -directions. With reference to the trajectory figure shown, we derive the nonlinear equations of motion of the ball with constant drag coefficient:

$$\Sigma F_x = ma_x, \quad \text{or: } 0.145 \frac{d^2x}{dt^2} = -F \cos \theta, \quad \text{where } F = C_D \frac{\rho}{2} \frac{\pi}{4} D^2 (V_x^2 + V_z^2)$$

$$\Sigma F_z = ma_z, \quad \text{or: } 0.145 \frac{d^2z}{dt^2} = -F \sin \theta - W, \quad \text{where } \theta = \tan^{-1}(V_z/V_x)$$

Assume  $mg = W = 0.145(9.81) = 1.42 \text{ N}$ ,  $\rho = 1.225 \text{ kg/m}^3$ ,  $D = 0.0735 \text{ m}$ , and  $V_x(0) = V_z(0) = 43.8(0.707) = 31.0 \text{ m/s}$ . Integrate numerically, by Runge-Kutta or whatever, for  $x(t)$  and  $z(t)$ , until the ball comes back down again and  $z = 0$ . The Reynolds number is in the transition range,  $Re_D \approx 222000$ . Most probably, due to ball/stitch roughness,  $C_D \approx 0.2$  (turbulent). We have also carried out the integration for  $C_D \approx 0.47$  (laminar). The results are:

$$C_D = 0.2: L \approx 130 \text{ m} \approx \mathbf{425 \text{ ft}} \quad \text{Ans. (b);} \quad \text{or: } C_D = 0.47: L \approx 92 \text{ m} \approx \mathbf{303 \text{ ft.}}$$

**7.71** A football weights 0.91 lbf and approximates an ellipsoid 6 in in diameter and 12 in long (Table 7.3). It is thrown upward at a  $45^\circ$  angle with an initial velocity of 80 ft/s. Neglect spin and lift. Assuming turbulent flow, estimate the horizontal distance traveled, (a) neglecting drag and (b) accounting for drag with a numerical (computer) model.

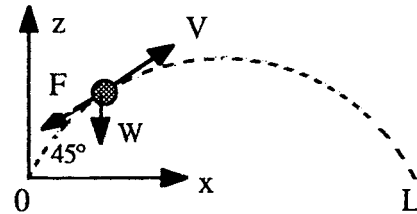


Fig. P7.71

**Solution:** For sea-level air, take  $\rho = 0.00238 \text{ slug/ft}^3$  and  $\mu = 3.71\text{E-}7 \text{ slug/ft}\cdot\text{s}$ . For a 2:1 ellipsoid, in Table 7.3, assume  $C_D \approx 0.13$  (turbulent flow).

(a) For zero drag, we make use of the simple physics formulas for particles:

$$\Delta x_{\max} = L = 2(V_o \cos 45^\circ)^2/g = V_o^2/g = (80)^2/32.2 \approx \mathbf{199 \text{ ft}} \quad \text{Ans. (a)}$$

(b) With drag of an ellipsoid ( $C_D \approx 0.13$ ) included, we need to use Newton's law in both the  $x$ - and  $z$ -directions. With reference to the figure above, we derive the nonlinear equations of motion of the ball with constant drag coefficient:

$$\Sigma F_x = ma_x, \quad \text{or: } \left( \frac{0.91}{32.2} \right) \frac{dV_x}{dt} = -F \cos \theta, \quad \text{where } F = C_D \frac{\rho}{2} (V_x^2 + V_z^2) \frac{\pi}{4} D^2$$

$$\Sigma F_z = ma_z, \quad \text{or: } \left( \frac{0.91}{32.2} \right) \frac{dV_z}{dt} = -F \sin \theta - W, \quad \text{where } \theta = \tan^{-1}(V_z/V_x)$$

Assume  $W = 0.91$  lbf,  $\rho = 0.00238$  slug/ft<sup>3</sup>,  $D = 0.5$  ft, and  $V_x(0) = V_z(0) = 80(0.707) = 56.6$  ft/s. Integrate numerically, by Runge-Kutta or whatever, for  $x(t)$  and  $z(t)$ , until the ball comes back down again and  $z = 0$ . The results are:

$$\Delta x_{\max} = L \approx \mathbf{171 \text{ ft}} \quad \text{at } t = 3.4 \text{ s} \quad (z_{\max} \approx 46 \text{ ft}) \quad \text{Ans. (b)}$$

**7.72** A settling tank for a municipal water supply is 2.5 m deep, and 20°C water flows through continuously at 35 cm/s. Estimate the minimum length of the tank which will ensure that all sediment (SG = 2.55) will fall to the bottom for particle diameters greater than (a) 1 mm and (b) 100  $\mu\text{m}$ .

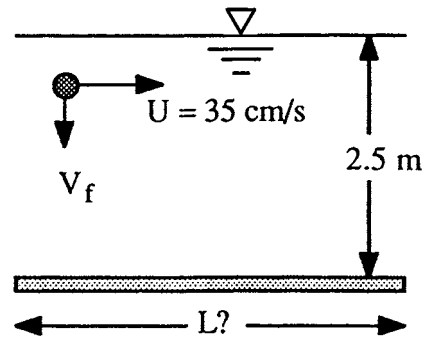


Fig. P7.72

**Solution:** For water at 20°C, take  $\rho = 998$  kg/m<sup>3</sup> and  $\mu = 0.001$  kg/m·s. The particles travel with the stream flow  $U = 35$  cm/s (no horizontal drag) and fall at speed  $V_f$  with drag equal to their net weight in water:

$$W_{\text{net}} = (SG - 1)\rho_w g \frac{\pi}{6} D^3 = \text{Drag} = C_D \frac{\rho_w}{2} V_f^2 \frac{\pi}{4} D^2, \quad \text{or:} \quad V_f^2 = \frac{4(SG - 1)gD}{3C_D}$$

where  $C_D = \text{fcn}(\text{Re}_D)$  from Fig. 7.16b. Then  $L = Uh/V_f$  where  $h = 2.5$  m.

$$\text{(a) } D = 1 \text{ mm: } V_f^2 = \frac{4(2.55 - 1)(9.81)(0.001)}{3C_D}, \quad \text{iterate Fig. 7.16b to } C_D \approx 1.0,$$

$$\text{Re}_D \approx 140, \quad V_f \approx 0.14 \text{ m/s,} \quad \text{hence } L = Uh/V_f = \frac{(0.35)(2.5)}{0.14} \approx \mathbf{6.3 \text{ m}} \quad \text{Ans. (a)}$$

$$\text{(b) } D = 100 \mu\text{m: } V_f^2 = \frac{4(2.55 - 1)(9.81)(0.0001)}{3C_D}, \quad \text{iterate Fig. 7.16b to } C_D \approx 36,$$

$$\text{Re}_D \approx 0.75, \quad V_f \approx 0.0075 \text{ m/s,} \quad L = \frac{0.35(2.5)}{0.0075} \approx \mathbf{120 \text{ m}} \quad \text{Ans. (b)}$$

**7.73** A balloon is 4 m in diameter and contains helium at 125 kPa and 15°C. Balloon material and payload weigh 200 N, not including the helium. Estimate (a) the terminal ascent velocity in sea-level standard air; (b) the final standard altitude (neglecting winds) at which the balloon will come to rest; and (c) the minimum diameter (<4 m) for which the balloon will just barely begin to rise in sea-level air.

**Solution:** For sea-level air, take  $\rho = 1.225 \text{ kg/m}^3$  and  $\mu = 1.78\text{E-}5 \text{ kg/m}\cdot\text{s}$ . For helium  $R = 2077 \text{ J/kg}\cdot\text{K}$ . Sea-level air pressure is 101350 Pa. For upward motion  $V$ ,

$$\text{Net buoyancy} = \text{weight} + \text{drag}, \quad \text{or:} \quad (\rho_{air} - \rho_{He})g \frac{\pi}{6} D^3 = W + C_D \frac{\rho}{2} V^2 \frac{\pi}{4} D^2$$

$$\text{or:} \quad \left[ 1.225 - \frac{125000}{2077(288)} \right] (9.81) \frac{\pi}{6} (4)^3 = 200 + C_D \left( \frac{1.225}{2} \right) V^2 \frac{\pi}{4} (4)^2$$

Guess *turbulent* flow:  $C_D \approx 0.2$ : Solve for  $V \approx 9.33 \text{ m/s}$  Ans. (a)

Check  $Re_D = 2.6\text{E}6$ : OK, turbulent flow.

(b) If the balloon comes to rest, buoyancy will equal weight, with no drag:

$$\left[ \rho_{air} - \frac{125000}{2077(288)} \right] (9.81) \frac{\pi}{6} (4)^3 = 200,$$

$$\text{Solve: } \rho_{air} \approx 0.817 \frac{\text{kg}}{\text{m}^3}, \quad Z_{\text{Table A6}} \approx 4000 \text{ m} \quad \text{Ans. (b)}$$

(c) If it just begins to rise at sea-level, buoyancy will be slightly greater than weight:

$$\left[ 1.225 - \frac{125000}{2077(288)} \right] (9.81) \frac{\pi}{6} D^3 > 200, \quad \text{or:} \quad D > 3.37 \text{ m} \quad \text{Ans. (c)}$$

**7.74** It is difficult to define the “frontal area” of a motorcycle due to its complex shape. One then measures the *drag-area*, that is,  $C_D A$ , in area units. Hoerner [12] reports the drag-area of a typical motorcycle, including the (upright) driver, as about  $5.5 \text{ ft}^2$ . Rolling friction is typically about 0.7 lbf per mi/h of speed. If that is the case, estimate the maximum sea-level speed (in mi/h) of the new Harley-Davidson *V-RodO* cycle, whose liquid-cooled engine produces 115 hp.

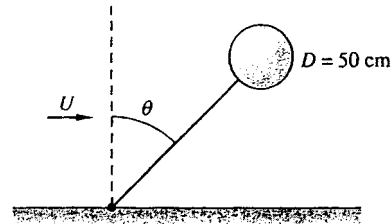
**Solution:** For sea-level air, take  $\rho = 0.00237 \text{ slug/ft}^3$ . Convert 0.7 lbf per mi/h rolling friction to 0.477 lbf per ft/s of speed. Then the power relationship for the cycle is

$$\text{Power} = (F_{dr} + F_{roll})V = \left( C_D A \frac{\rho}{2} V^2 + C_{roll} V \right) V,$$

$$\text{or: } 115 \cdot 550 \frac{\text{ft} \cdot \text{lbf}}{\text{s}} = \left[ (5.5 \text{ ft}^2) \frac{0.00237 \text{ slug/ft}^3}{2} V^2 + \left( 0.477 \frac{\text{lbf}}{\text{ft/s}} \right) V \right] V$$

Solve this cubic equation, by iteration or EES, to find  $V_{\max} \approx 192 \text{ ft/s} \approx \mathbf{131 \text{ mi/h}}$ . *Ans.*

**7.75** The helium-filled balloon in Fig. P7.75 is tethered at  $20^\circ\text{C}$  and 1 atm with a string of negligible weight and drag. The diameter is 50 cm, and the balloon material weighs 0.2 N, not including the helium. The helium pressure is 120 kPa. Estimate the tilt angle  $\theta$  if the airstream velocity  $U$  is (a) 5 m/s or (b) 20 m/s.



**Fig. P7.75**

**Solution:** For air at  $20^\circ\text{C}$  and 1 atm, take  $\rho = 1.2 \text{ kg/m}^3$  and  $\mu = 1.8\text{E-}5 \text{ kg/m}\cdot\text{s}$ . For helium,  $R = 2077 \text{ J/kg}\cdot\text{K}$ . The helium density =  $(120000)/[2077(293)] \approx 0.197 \text{ kg/m}^3$ .

The balloon net buoyancy is independent of the flow velocity:

$$B_{\text{net}} = (\rho_{\text{air}} - \rho_{\text{He}})g \frac{\pi}{6} D^3 = (1.2 - 0.197)(9.81) \frac{\pi}{6} (0.5)^3 \approx 0.644 \text{ N}$$

The net upward force is thus  $F_z = (B_{\text{net}} - W) = 0.644 - 0.2 = 0.444 \text{ N}$ . The balloon drag *does* depend upon velocity. At 5 m/s, we expect laminar flow:

$$\text{(a) } U = 5 \frac{\text{m}}{\text{s}}: \text{Re}_D = \frac{1.2(5)(0.5)}{1.8\text{E-}5} = 167000; \text{ Table 7.3: } C_D \approx 0.47$$

$$\text{Drag} = C_D \frac{\rho}{2} U^2 \frac{\pi}{4} D^2 = 0.47 \left( \frac{1.2}{2} \right) (5)^2 \frac{\pi}{4} (0.5)^2 \approx 1.384 \text{ N}$$

$$\text{Then } \theta_a = \tan^{-1} \left( \frac{\text{Drag}}{F_z} \right) = \tan^{-1} \left( \frac{1.384}{0.444} \right) = \mathbf{72^\circ} \text{ Ans. (a)}$$

(b) At 20 m/s,  $\text{Re} = 667000$  (*turbulent*), Table 7.3:  $C_D \approx 0.2$ :

$$\text{Drag} = 0.2 \left( \frac{1.2}{2} \right) (20)^2 \frac{\pi}{4} (0.5)^2 = 9.43 \text{ N}, \quad \theta_b = \tan^{-1} \left( \frac{9.43}{0.444} \right) = \mathbf{87^\circ} \text{ Ans. (b)}$$

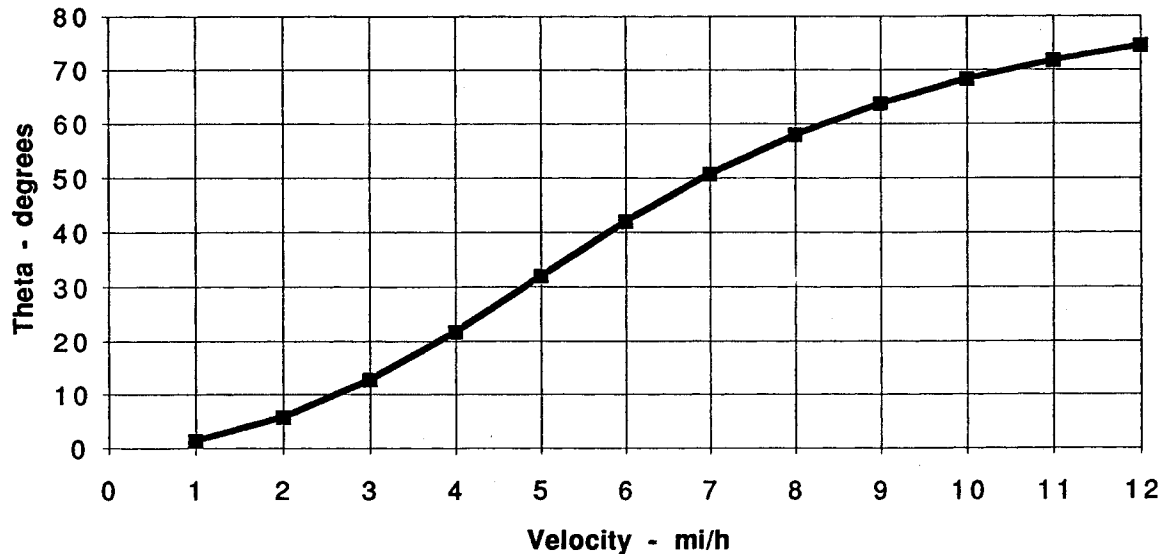
These angles are too steep—the balloon needs more buoyancy and/or less drag.

**7.76** Extend Problem 7.75 to make a smooth plot of tilt angle  $\theta$  versus stream velocity  $U$  in the range  $1 < U < 12$  mi/h (use a spreadsheet). Comment on the effectiveness of this system as an air-velocity instrument.

**Solution:** The spreadsheet calculates the drag and divides by the constant upward force of 0.444 N to calculate and plot the angle:

$$\theta = fcn(U) = \tan^{-1} \left[ \frac{C_D(\rho/2)U^2(\pi D^2/4)}{0.444 \text{ N}} \right], \quad C_D = fcn(\text{Re}_D)$$

The results are shown in the plot given below. At these velocities, all Reynolds numbers are less than 200,000, so a smooth sphere will be laminar,  $C_D \approx 0.47$ . We see that the plot, in principle, shows a nice spread of angles, from zero to 74 degrees, for these velocities. However, because of the unsteady, pulsating nature of the wake of a sphere in a stream, the balloon would no doubt *oscillate* in the stream and the tilt angle would be difficult to estimate accurately.



**Problem 7.76: Balloon Tilt Angle Versus Flow Velocity**

**7.77** To measure the drag of an upright person, without violating human-subject protocols, a life-sized mannequin is attached to the end of a 6-m rod and rotated at  $\Omega = 80$  rev/min, as in Fig. P7.77. The power required to maintain the rotation is 60 kW. By including rod-drag power, which is significant, estimate the drag-area  $C_D A$  of the mannequin, in  $\text{m}^2$ .

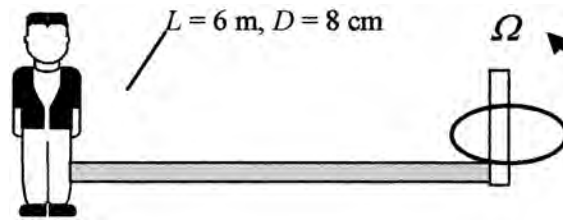


Fig. P7.77

**Solution:** For air, take  $\rho = 1.2 \text{ kg/m}^3$  and  $\mu = 1.8\text{E-}5 \text{ kg/m}\cdot\text{s}$ . The mannequin velocity is  $V_m = \Omega L = [(80 \times 2\pi/60)\text{rad/s}](6\text{m}) \approx (8.38 \text{ rad/s})(6 \text{ m}) \approx 50.3 \text{ m/s}$ . The velocity at mid-span of the rod is  $\Omega L/2 = 25 \text{ m/s}$ . Crudely estimate the power to rotate the rod:

$$\text{Re}_D = \frac{VD}{\nu} = \frac{(25 \text{ m/s})(0.08 \text{ m})}{0.000015 \text{ m}^2/\text{s}} = 133000, \quad \text{Table 7.2: } C_{D,rod} \approx 1.2$$

$$P_{rod} \approx \int_0^L \left( C_D \frac{\rho}{2} \Omega^2 r^2 D dr \right) r \approx C_D \frac{\rho}{2} \Omega^2 D \frac{L^4}{4}$$

$$\text{Input the data: } P_{rod} = (1.2) \frac{1.2}{2} (8.38)^2 (0.08) \frac{6.0^4}{4} \approx 1300 \text{ W}$$

Rod power is thus only about 2% of the total power. The total power relation is:

$$P = P_{rod} + (C_D A)_{man} \left( \frac{\rho}{2} \right) V^3 = 1300 + (C_D A)_{man} \left( \frac{1.2}{2} \right) (50.3)^3 = 60000 \text{ W}$$

$$\text{Solve for } (C_D A)_{mannequin} \approx 0.77 \text{ m}^2 \quad \text{Ans.}$$

**7.78** Apply Prob. 7.61 to a filter consisting of 300- $\mu\text{m}$ -diameter fibers packed 250 per square centimeter in the plane of Fig. P7.61. For air at 20°C and 1 atm flowing at 1.5 m/s, estimate the pressure drop if the filter is 5 cm thick.

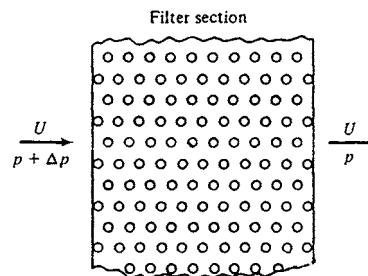


Fig. P7.61

**Solution:** For air at 20°C and 1 atm, take  $\rho = 1.2 \text{ kg/m}^3$  and  $\mu = 1.8\text{E-}5 \text{ kg/m}\cdot\text{s}$ . In Prob. 7.61 we derived the pressure-drop expression

$$\Delta p_{\text{filter}} \approx \text{NLC}_D \frac{\rho}{2} U^2 D, \quad \text{where } N = \text{no. of fibers per unit area}$$



Here,  $N = 250/\text{cm}^2 = 2.5\text{E}6$  per square meter (about 18% solidity). The drag coefficient is based on the Reynolds number (here uncorrected for solidity):

$$\text{Re}_D = \frac{\rho U D}{\mu} = \frac{1.2(1.5)(0.0003)}{1.8\text{E}-5} \approx 30; \quad \text{Fig. 7.16a: } C_D \approx 2.0$$

$$\text{Then } \Delta p \approx \text{NLC}_D \frac{\rho}{2} U^2 D = (2.5\text{E}6)(0.05)(2.0) \left( \frac{1.2}{2} \right) (1.5)^2 (0.0003) \approx \mathbf{100 \text{ Pa}} \quad \text{Ans.}$$

**7.79** A radioactive dust particle approximate a sphere with a density of  $2400 \text{ kg/m}^3$ . How long, in days, will it take the particle to settle to sea level from 12 km altitude if the particle diameter is (a)  $1 \mu\text{m}$ ; (b)  $20 \mu\text{m}$ ?

**Solution:** For such small particles, tentatively assume that Stokes' law prevails:

$$F_{\text{drag}} \approx 3\pi\mu DV = W_{\text{net}} = (\rho_p - \rho_{\text{air}})g \frac{\pi}{6} D^3 = (2400 - 1 \text{ or so})(9.81) \frac{\pi}{6} D^3 \approx 12320D^3$$

$$\text{Thus } V_{\text{fall}} \approx (12320D^3)/[3\pi D\mu] \approx 1307D^2/\mu = -dZ/dt, \quad \text{where } Z = \text{altitude}$$

Thus the time to fall varies inversely as  $D^2$  and depends on an average viscosity in the air:

$$\Delta t_{\text{fall}} = \frac{1}{1307D^2} \int_0^{12000} \mu dZ = \frac{12000}{1307D^2} \mu_{\text{avg}}|_{0-12000}, \quad \text{Table A-6 gives } \mu_{\text{avg}} \approx 1.61\text{E}-5 \frac{\text{kg}}{\text{m}\cdot\text{s}}$$

Try our two different diameters and check the Reynolds number for Stokes' flow:

$$\text{(a) } D = 1 \mu\text{m}: \quad \Delta t = \frac{12000(1.61\text{E}-5)}{1307(1\text{E}-6)^2} \approx 1.48\text{E}8 \text{ s} \approx \mathbf{1710 \text{ days}} \quad \text{Ans. (a)}$$

$$\text{Re}_{\text{max}} \approx 5\text{E}-6 \ll 1, \text{ OK}$$

$$\text{(b) } D = 20 \mu\text{m}: \quad \Delta t = \frac{12000(1.61\text{E}-5)}{1307(2\text{E}-5)^2} \approx 3.70\text{E}5 \text{ s} \approx \mathbf{4.3 \text{ days}} \quad \text{Ans. (b)}$$

$$\text{Re}_{\text{max}} \approx 0.04 \ll 1, \text{ OK}$$

**7.80** A heavy sphere attached to a string should hang at an angle  $\theta$  when immersed in a stream of velocity  $U$ , as in Fig. P7.80. Derive an expression for  $\theta$  as a function of the sphere and flow properties. What is  $\theta$  if the sphere is steel (SG = 7.86) of diameter 3 cm and the flow is sea-level standard air at  $U = 40$  m/s? Neglect the string drag.

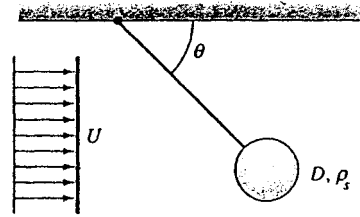
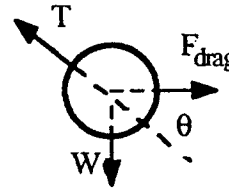


Fig. P7.80

**Solution:** For sea-level air, take  $\rho = 1.225$  kg/m<sup>3</sup> and  $\mu = 1.78E-5$  kg/m·s. The sphere should hang so that string tension balances the resultant of drag and net weight:



$$\tan \theta = \frac{W_{\text{net}}}{\text{Drag}}, \quad \text{or} \quad \theta = \tan^{-1} \left[ \frac{(\rho_s - \rho)g(\pi/6)D^3}{(\pi/8)C_D\rho U^2 D^2} \right] \quad \text{Symbolic answer.}$$

For the given numerical data, first check Re and the drag coefficient, then find the angle:

$$\text{Re}_D = \frac{1.225(40)(0.03)}{1.78E-5} \approx 83000, \quad \text{Fig. 7.16b: } C_D \approx \mathbf{0.5}$$

$$F = \frac{\pi}{8}(0.5)(1.225)(40)^2(0.03)^2 \approx 0.346 \text{ N;}$$

$$W = [7.86(998) - 1.225](9.81)\frac{\pi}{6}(0.03)^3 \approx 1.09 \text{ N} \quad \therefore \theta = \tan^{-1}(1.09/0.346) \approx \mathbf{72^\circ} \quad \text{Ans.}$$

**7.81** A typical U.S. Army parachute has a projected diameter of 28 ft. For a payload mass of 80 kg, (a) what terminal velocity will result at 1000-m standard altitude? For the same velocity and payload, what size drag-producing “chute” is required if one uses a square flat plate held (b) vertically; and (c) horizontally? (Neglect the fact that flat shapes are not dynamically stable in free fall.) Neglect plate weight.

**Solution:** For air at 1000 meters, from Table A-3,  $\rho \approx 1.112$  kg/m<sup>3</sup>. Convert  $D = 28$  ft = 8.53 m. Convert  $W = mg = 80(9.81) = 785$  N. From Table 7-3 for a parachute, read  $C_D \approx 1.2$ . Then, for part (a),

$$W = 785 \text{ N} = \text{Drag} = 1.2 \left( \frac{1.112}{2} \right) U^2 \frac{\pi}{4} (8.53)^2, \quad \text{solve for } U \approx \mathbf{4.53} \frac{\text{m}}{\text{s}} \quad \text{Ans. (a)}$$

(c) From Table 7-3 for a square plate normal to the stream, read  $C_D \approx 1.18$ . Then

$$W = 785 \text{ N} = \text{Drag} = 1.18 \left( \frac{1.112}{2} \right) (4.53)^2 L^2, \quad \text{solve for } L \approx 7.63 \text{ m} = \mathbf{25 \text{ ft}} \quad \text{Ans. (c)}$$

This is a comparable size to the parachute, but a square plate is ungainly and unstable.

(b) For a square plate parallel to the stream use (*turbulent*) flat plate theory. We need the viscosity—at 1000 meters altitude, estimate  $\mu_{\text{air}} \approx 1.78\text{E-}5 \text{ kg/m}\cdot\text{s}$ . Then

$$W = 785 \text{ N} = \text{Drag} = \frac{0.031}{[1.112(4.53)L/1.78\text{E-}5]^{1/7}} \left( \frac{1.112}{2} \right) (4.53)^2 L^2 (2 \text{ sides})$$

$$\text{Solve for } L \approx 114 \text{ m} = \mathbf{374 \text{ ft}} \quad \text{Ans. (b)}$$

This is ridiculous, as it was meant to be. A plate parallel to the stream is a *low-drag* device. You would need a plate the size of a football field.

**7.82** The average skydiver, with parachute unopened, weighs 175 lbf and has a drag-area  $C_D A \approx 9 \text{ ft}^2$  spread-eagled and  $1.2 \text{ ft}^2$  falling feet-first (see Table 7.3). What are the minimum and maximum terminal speed achieved by a skydiver at 5000-ft standard altitude?

**Solution:** At 5000 ft (1524 m) altitude, from Table A-6 with units conversion,  $\rho \approx 0.00205 \text{ slug/ft}^3$ . With drag-area known, we may solve the weight-drag relation for  $V$ :

$$W = C_D \frac{\rho}{2} V^2 A, \quad \text{or} \quad V = \sqrt{\frac{2W}{\rho C_D A}} = \sqrt{\frac{2(175)}{0.00205 C_D A}} = \frac{413}{\sqrt{C_D A}}$$

$$\text{Min: } V_{\min} = \frac{413}{\sqrt{9}} \approx \mathbf{138 \frac{\text{ft}}{\text{s}}}; \quad \text{(b) Max: } V_{\max} = \frac{413}{\sqrt{1.2}} \approx \mathbf{377 \frac{\text{ft}}{\text{s}}} \quad \text{Ans.}$$

**7.83** A high-speed car has a drag coefficient of 0.3 and a frontal area of  $1.0 \text{ m}^2$ . A parachute is to be used to slow this 2000-kg car from 80 to 40 m/s in 8 s. What should the chute diameter be? What distance will be travelled during deceleration? Assume sea-level air.

**Solution:** For sea-level air, take  $\rho = 1.225 \text{ kg/m}^3$  and  $\mu = 1.78\text{E-}5 \text{ kg/m}\cdot\text{s}$ . The solution this problem follows from Eq. (1) of Example 7.7.

$$V = V_o / [1 + (K/m)V_o t] \quad \text{where } K = \frac{\rho}{2} (C_{D\text{car}} A_{\text{car}} + C_{D\text{chute}} A_{\text{chute}})$$

Take  $C_{D\text{chute}} = 1.2$ . Enter the given data at  $t = 8$  sec and find the desired value of  $K$ :

$$V = 40 = \frac{80}{1 + (K/2000)(80)(8 \text{ s})}, \quad \text{solve for } K \approx 3.125 = \frac{1.225}{2} \left[ 0.3(1) + 1.2 \frac{\pi}{4} D^2 \right]$$

Solve for  $D \approx 2.26 \text{ m}$  Ans. (a)

The distance travelled is given as Eq. (2) of Ex. 7.7:

$$\alpha = \frac{K}{m} V_o = \frac{3.125}{2000} (80) = 0.125 \text{ s}^{-1}, \quad S = \frac{V_o}{\alpha} \ln(1 + \alpha t) = \frac{80}{0.125} \ln[1 + 0.125(8)]$$

or  $S \approx 440 \text{ m}$  Ans. (b)

**7.84** A Ping-Pong ball weighs 2.6 g and has a diameter of 3.8 cm. It can be supported by an air jet from a vacuum cleaner outlet, as in Fig. P7.84. For sea-level standard air, what jet velocity is required?

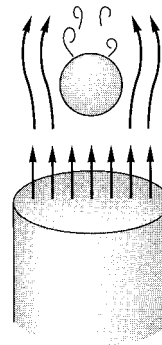


Fig. P7.84

**Solution:** For sea-level air, take  $\rho = 1.225 \text{ kg/m}^3$  and  $\mu = 1.78\text{E-}5 \text{ kg/m}\cdot\text{s}$ . The ball weight must balance its drag:

$$W = 0.0026(9.81) = 0.0255 \text{ N} = C_D \frac{\rho}{2} V^2 \frac{\pi}{4} D^2 = C_D \frac{1.225}{2} V^2 \frac{\pi}{4} (0.038)^2, \quad C_D = \text{fcn}(\text{Re})$$

$$C_D V^2 = 36.7, \quad \text{Use Fig. 7.16b, converges to } C_D \approx 0.47, \quad \text{Re} \approx 23000, \quad V \approx 9 \frac{\text{m}}{\text{s}} \quad \text{Ans.}$$

**7.85** An aluminum cylinder (SG = 2.7) slides concentrically down a taut 1-mm-diameter wire as shown in the figure. Its length is  $L = 8$  cm and its radius  $R = 1$  cm. A 2-mm-diameter hole down the cylinder center is lubricated by SAE 30 oil at 20°C. Estimate the terminal fall velocity  $V$  if ambient air drag is (a) neglected; or (b) included. Assume air at 1 atm and 20°C.

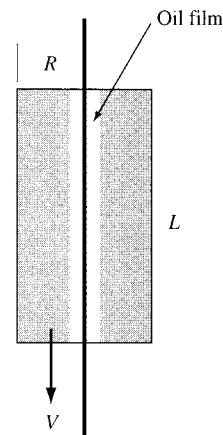


Fig. P7.85

**Solution:** For SAE 30 oil, from Table A-3,  $\mu_{\text{oil}} \approx 0.29 \text{ kg/m}\cdot\text{s}$ . Calculate the weight of the cylinder:

$$W = \rho_{\text{alum}} g \pi (R^2 - r_{\text{hole}}^2) L = [2.7(998)](9.81)\pi(0.01^2 - 0.001^2)(0.08) = 0.658 \text{ N}$$

From Problem 4.89, the (laminar) shear stress at the inner wall of the cylinder is

$$\tau_{w\text{-inner}} = \frac{\mu V}{r_{\text{hole}} \ln\left(\frac{r_{\text{hole}}}{r_{\text{wire}}}\right)} = \frac{0.29V}{0.001 \ln(2)} \approx 418V \quad \left(\text{with } V \text{ in } \frac{\text{m}}{\text{s}}\right)$$

(a) If air drag is neglected, the oil-stress force balances the cylinder weight:

$$W = 0.658 \text{ N} = \tau_w 2\pi r_{\text{hole}} L = (418V)2\pi(0.001)(0.08),$$

$$\text{Solve for } V_{\text{oil-only}} \approx \mathbf{3.13} \frac{\text{m}}{\text{s}} \quad \text{Ans. (a)}$$

(b) For air take  $\rho_{\text{air}} = 1.2 \text{ kg/m}^3$ . From Table 7-3 for flat cylinder,  $C_D \approx 0.99$ . Thus

$$W = 0.658 = \tau_w 2\pi r_{\text{hole}} L + C_D \frac{\rho_{\text{air}}}{2} V^2 \pi R^2 = 0.210V + 0.000187V^2$$

$$\text{Rearrange: } V^2 + 1127V - 3525 = 0, \quad \text{solve } V_{\text{oil+air}} \approx \mathbf{3.12} \frac{\text{m}}{\text{s}} \quad \text{Ans. (b)}$$

We see that air drag is negligible in this thick-oil, low-speed situation.

**7.86** Hoerner [Ref. 12 of Chap. 7, p. 3–25] states that the drag coefficient of a flag of 2:1 aspect ratio is 0.11 based on planform area. URI has an aluminum flagpole 25 m high and 14 cm in diameter. It flies equal-sized national and state flags together. If the fracture stress of aluminum is 210 MPa, what is the maximum flag size that can be used yet avoids breaking the flagpole in hurricane (75 mi/h) winds? Neglect the drag of the flagpole.

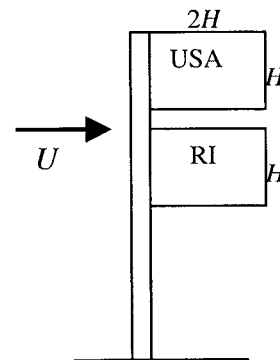


Fig. P7.86

**Solution:** URI is approximately sea-level,  $\rho = 1.225 \text{ kg/m}^3$ . Convert  $75 \text{ mi/h} = 33.5 \text{ m/s}$ . We will use the most elementary strength of materials formula, without even a stress-concentration factor, since this is just a *fluid mechanics* book:

$$\sigma = \frac{My}{I} = 210E6 \text{ Pa} = \frac{M(0.07 \text{ m})}{(\pi/4)(0.07 \text{ m})^4}, \quad \text{solve for } M_{fracture} = 56600 \text{ N}\cdot\text{m}$$

Assume flags are at the top (see figure) with no space between. Each flag is “ $H$ ” by “ $2H$ .” Then,

$$M = 56600 \text{ N}\cdot\text{m} = F_{USA} \left( 25 \text{ m} - \frac{H}{2} \right) + F_{RI} \left( 25 \text{ m} - \frac{3H}{2} \right),$$

$$\text{where } F_{USA} = F_{RI} = 0.11 \left( \frac{1.225}{2} \right) (33.5)^2 H(2H)$$

Iterate or use EES:  $F = 1281 \text{ N}$ ,  $H = 2.91 \text{ m}$ , Flag length =  $2H = 5.82 \text{ m}$  *Ans.*

---

**7.87** A tractor-trailer truck has a drag area  $C_D A = 8 \text{ m}^2$  bare and  $C_D A = 6.7 \text{ m}^2$  with a deflector added (Fig. 7.18b). Its rolling resistance is  $50 \text{ N}$  for each  $\text{mi/h}$  of speed. Calculate the total horsepower required if the truck moves at (a)  $55 \text{ mi/h}$ ; and (b)  $75 \text{ mi/h}$ .

**Solution:** For sea-level air, take  $\rho = 1.225 \text{ kg/m}^3$  and  $\mu = 1.78E-5 \text{ kg/m}\cdot\text{s}$ . Convert  $V = 55 \text{ mi/h} = 24.6 \text{ m/s}$  and  $75 \text{ mi/h} = 33.5 \text{ m/s}$ . Take each speed in turn:

$$(a) \quad 55 \frac{\text{mi}}{\text{h}}: \quad F_{bare} = (8 \text{ m}^2) \left( \frac{1.225}{2} \right) (24.6)^2 + 50(55) = 2962 + 2750 = 5712 \text{ N}$$

$$\text{Power required} = FV = (5712)(24.6) = 140 \text{ kW} \approx \mathbf{188 \text{ hp}} \text{ (bare)}$$

$$\text{with a deflector, } F \approx 2481 + 2750 = 5231 \text{ N, } \text{Power} = 129 \text{ kW} \approx \mathbf{172 \text{ hp}} \text{ (-8\%)}$$

$$(b) \quad 75 \frac{\text{mi}}{\text{h}}: \quad F = 8 \left( \frac{1.225}{2} \right) (33.5)^2 + 50(75) = 9258 \text{ N,}$$

$$\text{Power} = 310 \text{ kW} \approx \mathbf{416 \text{ hp}} \text{ (bare)}$$

$$\text{With deflector, } F = 8363 \text{ N, } \text{Power} = 280 \text{ kW} \approx \mathbf{376 \text{ hp}} \text{ (-10\%)}$$


---

**7.88** A pickup truck has a clean drag-area  $C_D A$  of  $35 \text{ ft}^2$ . Estimate the horsepower required to drive the truck at  $55 \text{ mi/h}$  (a) clean and (b) with the 3- by 6-ft sign in Fig. P7.88 installed if the rolling resistance is  $150 \text{ lbf}$  at sea level.

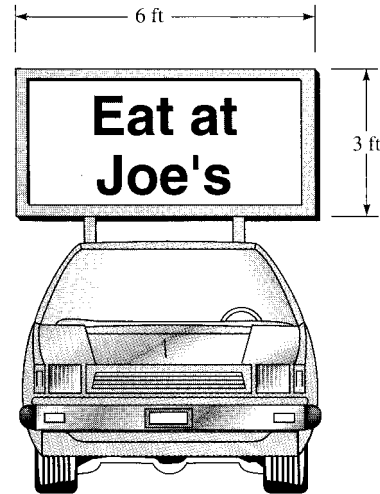


Fig. P7.88

**Solution:** For sea-level air, take  $\rho = 0.00238 \text{ slug/ft}^3$  and  $\mu = 3.72\text{E-}7 \text{ slug/ft}\cdot\text{s}$ . Convert  $V = 55 \text{ mi/h} = 80.7 \text{ ft/s}$ . Calculate the drag without the sign:

$$F = F_{\text{rolling}} + C_D A \frac{\rho}{2} V^2$$

$$= 150 + 35(0.00238/2)(80.7)^2 \approx 421 \text{ lbf}$$

$$\text{Horsepower} = (421)(80.7) \div 550 \approx \mathbf{62 \text{ hp}} \quad \text{Ans. (a)}$$

With a sign added,  $b/h = 2.0$ , read  $C_D \approx \mathbf{1.19}$  from Table 7.3. Then

$$F = 421_{\text{clean}} + 1.19 \left( \frac{0.00238}{2} \right) (80.7)^2 (6)(3) \approx 587 \text{ lbf,}$$

$$\text{Power} = FV \approx \mathbf{86 \text{ hp}} \quad \text{Ans. (b)}$$

**7.89** The new AMTRAK high-speed *Acela* train can reach  $150 \text{ mi/h}$ , which presently it seldom does, because of the curvy coastline tracks in New England. If 75% of the power expended at this speed is due to air drag, estimate the total horsepower required by the *Acela*.

**Solution:** For sea-level air, take  $\rho = 1.22 \text{ kg/m}^3$ . From Table 7.3, the drag-area  $C_D A$  of a streamlined train is approximately  $8.5 \text{ m}^2$ . Convert  $150 \text{ mi/h}$  to  $67.1 \text{ m/s}$ . Then

$$0.75P_{\text{train}} = \left[ (C_D A) \frac{\rho}{2} V^2 \right] V = (8.5 \text{ m}^2) \left( \frac{1.22 \text{ kg/m}^3}{2} \right) (67.1 \text{ m/s})^3 = 1.56\text{E}6 \text{ watts}$$

$$\text{Solve for } P_{\text{train}} = 2.08\text{E}6 \text{ W} = \mathbf{2800 \text{ hp}} \quad \text{Ans.}$$

**7.90** In the great hurricane of 1938, winds of 85 mi/h blew over a boxcar in Providence, Rhode Island. The boxcar was 10 ft high, 40 ft long, and 6 ft wide, with a 3-ft clearance above tracks 4.8 ft apart. What wind speed would topple a boxcar weighing 40,000 lbf?

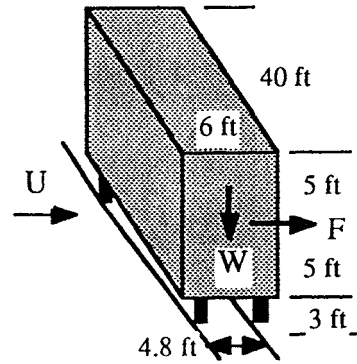


Fig. P7.90

**Solution:** For sea-level air, take  $\rho = 0.00238$  slug/ft<sup>3</sup> and  $\mu = 3.72E-7$  slug/ft·s. From Table 7.3 for  $b/h = 4$ , estimate  $C_D \approx 1.2$ . The estimated drag force  $F$  on the left side of the box car is thus

$$F = C_D \frac{\rho}{2} V^2 b h = 1.2 \left( \frac{0.00238}{2} \right) V^2 (40)(10) \approx 0.5712 V^2 \quad (\text{in ft}\cdot\text{lbf})$$

Sum moments about right wheels:  $(0.5712 V^2)(8 \text{ ft}) - (40000 \text{ lbf})(2.4 \text{ ft}) = 0$ ,  $V^2 = 21008$

$$\text{Solve } V_{\text{overturn}} = 145 \text{ ft/s} \approx \mathbf{99 \text{ mi/h}} \quad \text{Ans.}$$

[The 1938 wind speed of 85 mi/h would overturn the car for a car weight of 29600 lbf.]

**7.91** A cup anemometer uses two 5-cm-diameter hollow hemispheres connected to two 15-cm rods, as in Fig. P7.91. Rod drag is neglected, and the central bearing has a retarding torque of 0.004 N·m. With simplifying assumptions, estimate and plot rotation rate  $\Omega$  versus wind velocity in the range  $0 < U < 25$  m/s.

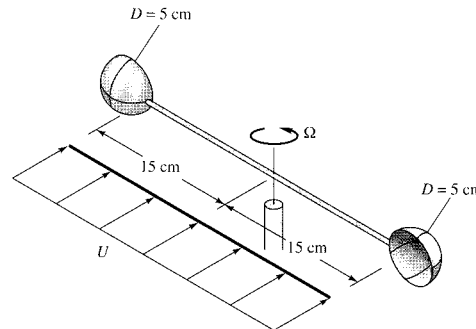
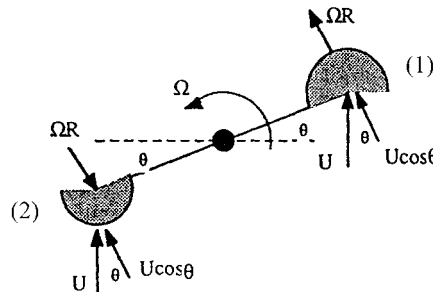


Fig. P7.91

**Solution:** For sea-level air, take  $\rho = 1.225$  kg/m<sup>3</sup> and  $\mu = 1.78E-5$  kg/m·s. For any instantaneous angle  $\theta$ , as shown, the drag forces are assumed to depend on the relative velocity normal to the cup:

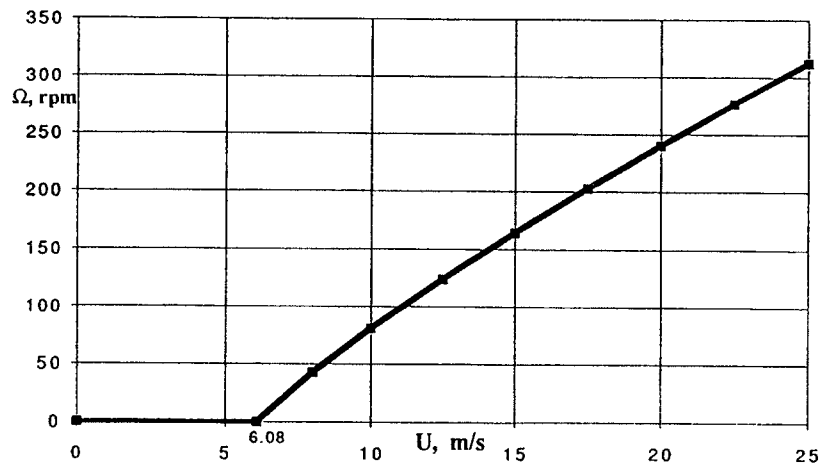
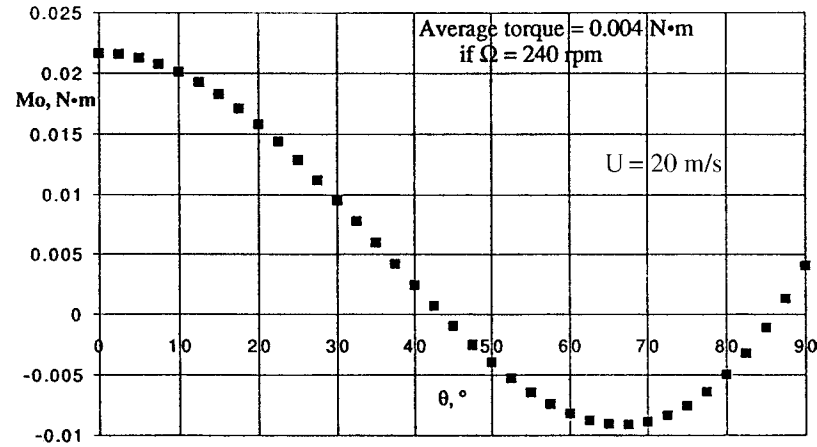
$$M_o = R \left[ C_{D1} \frac{\rho}{2} (U \cos \theta - \Omega R)^2 - C_{D2} \frac{\rho}{2} (U \cos \theta + \Omega R)^2 \right],$$

$$C_{D1} \approx 1.4, \quad C_{D2} \approx 0.4$$





For a given wind velocity  $0 < U < 25$  m/s, we find the rotation rate  $\Omega$  (here in rad/s) for which the average torque over a  $90^\circ$  sweep is exactly equal to the frictional torque of  $0.004$  N·m. [The torque given by the formula mirrors itself over  $90^\circ$  increments.] For  $U = 20$  m/s, the torque variation given by the formula is shown in the graph below. We do this for the whole range of  $U$  values and then plot  $\Omega$  (in rev/min) versus  $U$  below. We see that the anemometer will not rotate until  $U \geq 6.08$  m/s. Thereafter the variation of  $\Omega$  with  $U$  is approximately linear, making this a popular wind-velocity instrument.



**7.92** A 1500-kg automobile uses its drag-area,  $C_D A = 0.4 \text{ m}^2$ , plus brakes and a parachute, to slow down from 50 m/s. Its brakes apply 5000 N of resistance. Assume sea-level standard air. If the automobile must stop in 8 seconds, what diameter parachute is appropriate?

**Solution:** For sea-level air take  $\rho = 1.225 \text{ kg/m}^3$ . From Table 7.3 for a parachute, read  $C_{Dp} \approx 1.2$ . The force balance during deceleration is, with  $V_o = 50 \text{ m/s}$ ,

$$\Sigma F = -F_{roll} - F_{drag} = -5000 - \frac{1.225}{2} \left( 0.4 + 1.2 \frac{\pi}{4} D_p^2 \right) V^2 = (ma)_{car} = 1500 \frac{dV}{dt}$$

Note that, if drag = 0, the car slows down linearly and stops in  $50(1500)/(5000) = 15 \text{ s}$ , not fast enough—so we definitely need the drag to cut it down to 8 seconds. The first-order differential equation above has the form

$$\frac{dV}{dt} = -b - aV^2, \quad \text{where } a = \frac{1.225}{2} \left( \frac{0.4 + 1.2\pi D_p^2/4}{1500} \right) \quad \text{and} \quad b = \frac{5000}{1500}$$

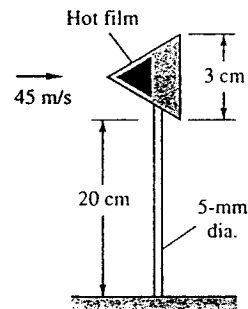
Separate the variables and integrate, with  $V = V_o = 50 \text{ m/s}$  at  $t = 0$ :

$$\int_{V_o}^0 \frac{dV}{b + aV^2} = - \int_0^t dt, \quad \text{Solve: } t = \frac{1}{\sqrt{ab}} \tan^{-1} \left( V_o \sqrt{\frac{a}{b}} \right) = 8 \text{ s}$$

The unknown is  $D_p$ , which lies within  $a$ ! Iteration is needed—an ideal job for EES! Well, anyway, you will find that  $D_p = 3 \text{ m}$  is too small ( $t \approx 9.33 \text{ s}$ ) and  $D_p = 4 \text{ m}$  is too large ( $t \approx 7.86 \text{ s}$ ). We may interpolate (or EES will quickly report):

$$D_{\text{parachute}(t=8 \text{ s})} \approx 3.9 \text{ m} \quad \text{Ans.}$$

**7.93** A hot-film probe is mounted on a cone-and-rod system in a sea-level airstream of  $45 \text{ m/s}$ , as in Fig. P7.93. Estimate the maximum cone vertex angle allowable if the flow-induced bending moment at the root of the rod is not to exceed  $30 \text{ N}\cdot\text{cm}$ .



**Fig. P7.93**

**Solution:** For sea-level air take  $\rho = 1.225 \text{ kg/m}^3$  and  $\mu = 1.78E-5 \text{ kg/m}\cdot\text{s}$ . First figure the rod's drag and moment, assuming it is a smooth cylinder:

$$Re_{D,rod} = \frac{1.225(45)(0.005)}{1.78E-5} = 15500, \quad \text{Fig.7.16a: read } C_{D,rod} \approx 1.2$$

$$F_{rod} = 1.2 \left( \frac{1.225}{2} \right) (45)^2 (0.005)(0.2) = 1.49 \text{ N}, \quad M_{base,rod} = 1.49(10) = 14.9 \text{ N}\cdot\text{cm}$$

Then add in the drag-moment of the cone about the base:

$$\Sigma M_{base} = 30 = 14.9 + C_{D,cone} \left( \frac{1.225}{2} \right) (45)^2 \left( \frac{\pi}{4} \right) (0.03)^2 (21.5 \text{ cm})$$

Solve for  $C_{D,cone} \approx 0.80$ , Table 7.3: read  $\theta_{cone} \approx 60^\circ$  Ans.

**7.94** A rotary mixer consists of two 1-m-long half-tubes rotating around a central arm, as in Fig. P7.94. Using the drag from Table 7.2, derive an expression for the torque  $T$  required to drive the mixer at angular velocity  $\Omega$  in a fluid of density  $\rho$ . Suppose that the fluid is water at  $20^\circ\text{C}$  and the maximum driving power available is 20 kW. What is the maximum rotation speed  $\Omega$  r/min?

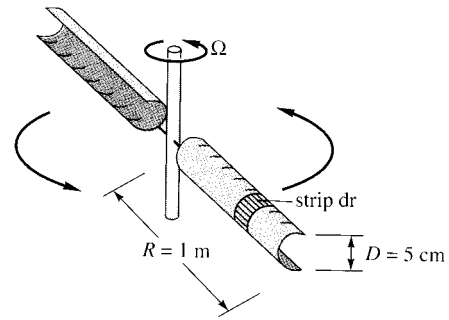


Fig. P7.94

**Solution:** Consider a *strip* of half-tube of width  $dr$ , as shown in Fig. P7.94 above. The local velocity is  $U = \Omega r$ , and the strip frontal area is  $Ddr$ . The total torque (2 tubes) is

$$T_o = 2 \int_{\text{tube}} r dF = 2 \int_0^R r \left[ C_D \frac{\rho}{2} (\Omega r)^2 D dr \right] \approx \frac{1}{4} C_D \rho \Omega^2 D R^4 \quad \text{Ans. (a)}$$

(b) For water at  $20^\circ\text{C}$ , take  $\rho = 998 \text{ kg/m}^3$  and  $\mu = 0.001 \text{ kg/m}\cdot\text{s}$ . Assume that the half-tube shape has the drag coefficient  $C_D \approx 2.3$  as in Table 7.2. Then, with power known,

$$P = 20000 \text{ W} = T_o \Omega = \left[ \frac{1}{4} (2.3)(998) \Omega^2 (0.05)(1.0)^4 \right] \Omega = 28.7 \Omega^3$$

$$\text{Solve for } \Omega_{\max} = 8.87 \frac{\text{rad}}{\text{s}} \times \frac{60}{2\pi} \approx 85 \frac{\text{rev}}{\text{min}} \quad \text{Ans. (b)}$$

**7.95** An airplane weighing 28 kN, with a drag-area  $C_D A = 5 \text{ m}^2$ , lands at sea level at 55 m/s and deploys a drag parachute 3 m in diameter. No other brakes are applied. (a) How long will it take the plane to slow down to 20 m/s? (b) How far will it have traveled in that time?

**Solution:** For sea-level air, take  $\rho = 1.225 \text{ kg/m}^3$  and  $\mu = 1.78\text{E-}5 \text{ kg/m}\cdot\text{s}$ . The analytical solution to this deceleration problem was given in Example 7.8 of the text: Take  $C_{D,\text{chute}} = 1.2$ .

$$V = \frac{V_o}{1 + \alpha t}, \quad \alpha = \frac{\rho g V_o}{2W} \sum C_D A = \frac{1.225(9.81)(55)}{2(28000)} \left[ 5 \text{ m}^2 + 1.2 \frac{\pi}{4} (3 \text{ m})^2 \right] = 0.159 \text{ s}^{-1}$$

(a) Then the time required to slow down from 55 m/s to 20 m/s, without brakes, is

$$20 \text{ m/s} = \frac{55 \text{ m/s}}{1 + 0.159t}, \quad \text{solve for } \mathbf{t = 11.0 \text{ s}} \quad \text{Ans. (a)}$$

(b) The distance traveled was also derived in Example 7.8:

$$S = \frac{V_o}{\alpha} \ln(1 + \alpha t) = \frac{55}{0.159} \ln[1 + 0.159(11.0)] \approx \mathbf{350 \text{ m}} \quad \text{Ans. (b)}$$

**7.96** A Savonius rotor (see Fig. 6.29*b*) can be approximated by the two open half-tubes in Fig. P7.96 mounted on a central axis. If the drag of each tube is similar to that in Table 7.2, derive an approximate formula for the rotation rate  $\Omega$  as a function of  $U$ ,  $D$ ,  $L$ , and the fluid properties  $\rho$  and  $\mu$ .

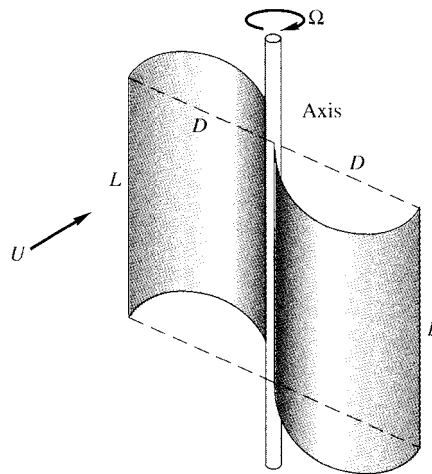


Fig. P7.96

**Solution:** The analysis is similar to Prob. 7.91 (the cup anemometer). At any arbitrary angle as shown, the net torque caused by the relative velocity on each half-tube is set to zero (assuming a frictionless bearing):

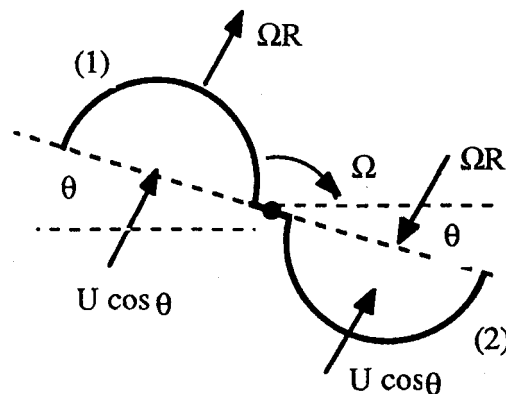
$$T_o = 0 = \frac{D}{2} (F_1 - F_2) \quad \text{where}$$

$$F_1 = C_{D1} (\rho/2) (U \cos \theta - \Omega D/2)^2 DL$$

$$F_2 = C_{D2} (\rho/2) (U \cos \theta + \Omega D/2)^2 DL$$

This pattern of torque repeats itself every  $90^\circ$ . Thus the torque is an average value:

$$T_{o,\text{avg}} = 0 \quad \text{if } F_{1,\text{avg}} = F_{2,\text{avg}}$$



$$\text{or } \frac{\rho}{2} \text{DLC}_{D1} \left( U \cos \theta - \Omega \frac{D}{2} \right)_{\text{avg}}^2 \approx \frac{\rho}{2} \text{DLC}_{D2} \left( U \cos \theta + \Omega \frac{D}{2} \right)_{\text{avg}}^2$$

$$\text{or: } U \cos \theta (1 - \zeta)_{\text{avg}} \approx \Omega \frac{D}{2} (1 + \zeta)_{\text{avg}}, \quad \zeta = \sqrt{\frac{C_{D2}}{C_{D1}}} = \sqrt{\frac{1.2}{2.3}} \approx 0.722$$

where  $C_{D1} = 2.3$  and  $C_{D2} = 1.2$  are taken from Table 7.2. The average value of  $\cos \theta$  over 0 to  $90^\circ$  is  $2/\pi \approx 0.64$ . Then a simple approximate expression for rotation rate is

$$\Omega_{\text{avg}} \approx \frac{2U}{D} \left[ \cos \theta \frac{1 - \zeta}{1 + \zeta} \right]_{\text{avg}} = \frac{2U}{D} \left[ \frac{2}{\pi} \left( \frac{1 - 0.722}{1 + 0.722} \right) \right] \approx \mathbf{0.21 \frac{U}{D}} \quad \text{Ans.}$$

**7.97** A simple measurement of automobile drag can be found by an unpowered *coastdown* on a level road with no wind. Assume constant rolling resistance. For an automobile of mass 1500 kg and frontal area  $2 \text{ m}^2$ , the following velocity-versus-time data are obtained during a coastdown:

$t, \text{ s:}$	0.00	10.0	20.0	30.0	40.0
$V, \text{ m/s:}$	27.0	24.2	21.8	19.7	17.9

Estimate (a) the rolling resistance and (b) the drag coefficient. This problem is well suited for digital-computer analysis but can be done by hand also.

**Solution:** For air, take  $\rho = 1.2 \text{ kg/m}^3$  and  $\mu = 1.8\text{E-}5 \text{ kg/m}\cdot\text{s}$ . Assuming that rolling friction is linearly proportional to the car velocity. Then the equation of motion is

$$\sum F_x = m \frac{dV}{dt} = -F_{\text{rolling}} - F_{\text{drag}} = -KV - C_D A \frac{\rho}{2} V^2.$$

$$\text{Separate and integrate: } \int_0^t dt = - \int_{V_0}^V \frac{dV}{(K/m)V + (C_D A \rho / 2m)V^2},$$

$$\text{or } t = \frac{m}{K} \ln \left[ \frac{K + C_D A \rho V / 2}{V} \frac{V_0}{K + C_D A \rho V_0 / 2} \right]$$

This is the formula which we must fit to the data. Introduce numerical values to get

$$t = \frac{-1500}{K} \ln \left[ \frac{K + 32.4 C_D}{27} \frac{V}{K + 1.2 V C_D} \right] \quad \text{solve by least squares for } \mathbf{K} \text{ and } \mathbf{C_D}.$$

The least-squares results are  $\mathbf{K \approx 9.1 \text{ N}\cdot\text{s/m}}$  and  $\mathbf{C_D \approx 0.24}$ . *Ans.*

These two values give *terrific* accuracy with respect to the data—deviations of less than  $\pm 0.06\%$ ! Actually, the data are not sensitive to  $K$  or  $C_D$ , at least if the two are paired nicely. Any  $K$  from 8 to 10 N·s/m, paired with  $C_D$  from 0.20 to 0.28, gives excellent accuracy. We need more data points to discriminate between parameters.

**7.98** A buoyant ball of specific gravity  $SG < 1$ , dropped into water at inlet velocity  $V_o$ , will penetrate a distance  $h$  and then pop out again, as in Fig. P7.98. (a) Make a dynamic analysis, assuming a constant drag coefficient, and derive an expression for  $h$  as a function of system properties. (b) How far will a 5-cm-diameter ball, with  $SG = 0.5$  and  $C_D = 0.47$ , penetrate if it enters at 10 m/s?

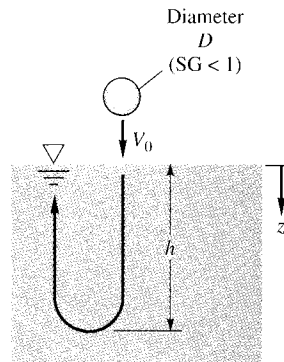


Fig. P7.98

**Solution:** The buoyant force is up,  $W_{\text{net}} = (1 - SG)\rho g(\pi/6)D^3$ , and with  $z$  down as shown, the equation of motion of the ball is

$$\sum F_z = m \frac{dV}{dt} = -W_{\text{net}} - C_D \frac{\rho}{2} V^2 A, \quad A = \frac{\pi}{4} D^2.$$

$$\text{Separate and integrate: } -\int_0^t dt = \int_{V_o}^V \frac{dV}{(W_{\text{net}}/m) + (C_D \rho A/2m)V^2},$$

$$\text{or } V = V_f \tan \left[ \tan^{-1} \left( \frac{V_o}{V_f} \right) - t \frac{W_{\text{net}}}{m V_f} \right] \quad \text{where } V_f = \sqrt{2W_{\text{net}}/(\rho C_D A)} \quad \text{for short.}$$

The total distance travelled until the ball stops (at  $V=0$ ) and turns back upwards is

$$h = \int_0^{t(V=0)} V dt = \frac{m}{\rho C_D A} \ln[1 + (V_o/V_f)^2] \quad \text{Ans. (a)}$$

(b) Apply the specific data to find the depth of penetration for a numerical example. For water, take  $\rho = 998 \text{ kg/m}^3$  and  $\mu = 0.001 \text{ kg/m}\cdot\text{s}$ .

$$W_{\text{net}} = (1 - 0.5)(9790) \frac{\pi}{6} (0.05)^3 \approx 0.320 \text{ N}; \quad m = 0.5(998) \frac{\pi}{6} (0.05)^3 \approx 0.0327 \text{ kg}$$

$$V_f = \sqrt{\frac{2(0.320 \text{ N})}{998(0.47)(\pi/4)(0.05)^2}} \approx 0.834 \frac{\text{m}}{\text{s}}, \quad \text{check } Re_f = \frac{998(0.834)(0.05)}{0.001} \approx 42000 \text{ OK}$$

Then the formula predicts total penetration depth of

$$h = \frac{0.0327 \text{ kg}}{998(0.47)(\pi/4)(0.05)^2} \ln \left[ 1 + \left( \frac{10.0}{0.834} \right)^2 \right] \approx \mathbf{0.18 \text{ m}} \quad \text{Ans. (b)}$$

NOTE: We have neglected “hydrodynamic” mass of the ball (Section 8.8).

**7.99** Two steel balls (SG = 7.86) are connected by a thin hinged rod of negligible weight and drag, as shown in Fig. P7.99. A stop prevents counter-clockwise rotation. Estimate the sea-level air velocity  $U$  for which the rod will first begin to rotate clockwise.

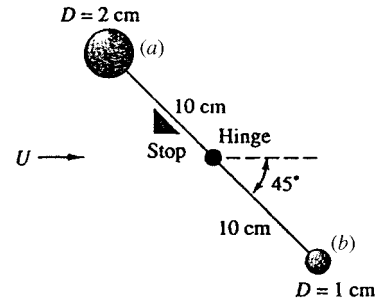


Fig. P7.99

**Solution:** For sea-level air, take  $\rho = 1.225 \text{ kg/m}^3$  and  $\mu = 1.78\text{E-}5 \text{ kg/m}\cdot\text{s}$ . Let “a” and “b” denote the large and small balls, respectively, as shown. The rod begins to rotate when the moments of drag and weight are balanced. The (clockwise) moment equation is

$$\Sigma M_o = F_a(0.1 \sin 45^\circ) - W_a(0.1 \cos 45^\circ) - F_b(0.1 \sin 45^\circ) + W_b(0.1 \cos 45^\circ) = 0$$

For  $45^\circ$ , there are nice cancellations to obtain  $\therefore F_a - F_b = W_a - W_b$ , or:

$$C_{Da} \frac{\rho}{2} U^2 \frac{\pi}{4} D_a^2 - C_{Db} \frac{\rho}{2} U^2 \frac{\pi}{4} D_b^2 = (SG)\rho_{\text{water}}g \frac{\pi}{6} D_a^3 - (SG)\rho_{\text{water}}g \frac{\pi}{6} D_b^3$$

Assuming that  $C_{Da} = C_{Db} \approx 0.47$  ( $Re < 250000$ ), we may easily solve for air velocity:

$$U^2(0.47) \left( \frac{1.225}{2} \right) \frac{\pi}{4} [(0.02)^2 - (0.01)^2] = (7.86)(9790) \frac{\pi}{6} [(0.02)^3 - (0.01)^3]$$

$$\text{Solve for } U = \sqrt{4158} \approx \mathbf{64 \text{ m/s}} \quad \text{Ans.}$$

We may check that  $Re_{\text{max}} = 1.225(64)(0.02)/1.78\text{E-}5 \approx 89000$ , OK,  $C_D \approx 0.47$ .

**7.100** A tractor-trailer truck is coasting freely, with no brakes, down an  $8^\circ$  slope at 1000-m standard altitude. Rolling resistance is 120 N for every m/s of speed. Its frontal area is  $9 \text{ m}^2$ , and the weight is 65 kN. Estimate the terminal coasting velocity, in mi/h, for (a) no deflector; and (b) a deflector installed.

**Solution:** For air at 100-m altitude,  $\rho = 1.112 \text{ kg/m}^3$ . Summing forces along the roadway gives:

$$W \sin \theta = F_{\text{drag}} + F_{\text{roll}} = C_D \frac{\rho}{2} V^2 A_{\text{frontal}} + C_{\text{roll}} V$$

(a, b) Applying the given data results in a quadratic equation:

$$\text{No deflector: } (65000 \text{ N}) \sin 8^\circ = (0.96) \left( \frac{1.112}{2} \right) (9.0) V^2 + 120V,$$

$$\text{or: } V^2 + 24.98V - 1883 = 0 \quad \text{Solve } V = 32.7 \text{ m/s} = \mathbf{73 \text{ mi/h}} \quad \text{Ans. (a)}$$

$$\text{With deflector: } (65000 \text{ N}) \sin 8^\circ = (0.76) \left( \frac{1.112}{2} \right) (9.0) V^2 + 120V,$$

$$\text{or: } V^2 + 31.55V - 2379 = 0 \quad \text{Solve } V = 35.5 \text{ m/s} = \mathbf{79 \text{ mi/h}} \quad \text{Ans. (b)}$$

**7.101** Icebergs can be driven at substantial speeds by the wind. Let the iceberg be idealized as a large, flat cylinder,  $D \gg L$ , with one-eighth of its bulk exposed, as in Fig. P7.101. Let the seawater be at rest. If the upper and lower drag forces depend upon relative velocities between the berg and the fluid, derive an approximate expression for the steady iceberg speed  $V$  when driven by wind velocity  $U$ .

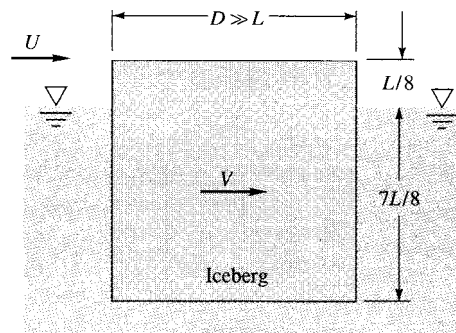
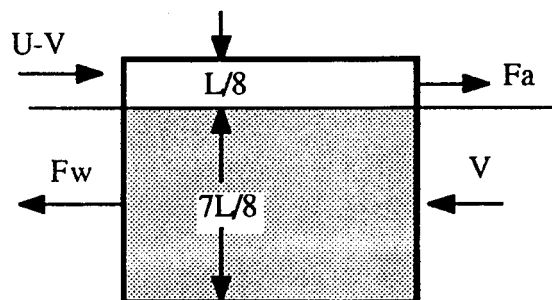


Fig. P7.101

**Solution:** Assuming steady drifting (no acceleration), the berg sees a water current  $V$  coming from the front and a relative air velocity  $U - V$  coming from behind. Ignoring moments (the berg will merely tilt slightly), the two forces must balance:

$$\begin{aligned} F_{\text{air}} &= C_{D,\text{air}} \frac{1}{2} \rho_{\text{air}} (U - V)^2 D \frac{L}{8} \\ &= F_{\text{water}} = C_{D,\text{water}} \frac{1}{2} \rho_{\text{water}} V^2 \frac{7L}{8} D \end{aligned}$$





This has the form of a quadratic equation:

$$U^2 - 2UV + V^2 = \alpha V^2, \quad \text{or} \quad V_{\text{berg}} = U_{\text{wind}} \left( \frac{\sqrt{\alpha} - 1}{\alpha - 1} \right) \quad \text{where} \quad \alpha = \frac{7\rho_w C_{Dw}}{\rho_a C_{Da}} \gg 1$$

Since  $\alpha = \mathcal{O}(5000)$ , we approximate  $V_{\text{berg}} \approx U/\sqrt{\alpha}$ .

**7.102** Sand particles ( $SG = 2.7$ ), approximately spherical with diameters from 100 to 250  $\mu\text{m}$ , are introduced into an upward-flowing water stream. What is the minimum water velocity to carry all the particles upward?

**Solution:** Clearly the largest particles need the most water speed. Set net weight = drag:

$$W_{\text{net}} = (\rho_p - \rho_w)g \frac{\pi}{6} D^3 = C_D \frac{\rho_w}{2} V^2 \frac{\pi}{4} D^2, \quad \text{solve} \quad V^2 = \frac{4gD(SG - 1)}{3C_D}$$

$$\text{or:} \quad C_D V^2 = \frac{4}{3}(9.81)(0.00025)(2.7 - 1) = \mathbf{0.00555} \quad \left( \text{with } V \text{ in } \frac{\text{m}}{\text{s}} \right)$$

Iterate in Figure 7.16b:  $Re_D \approx 10$ ,  $C_D \approx 4$ ,  $V_{\text{min}} \approx \mathbf{0.04 \text{ m/s}}$  Ans.

**7.103** When immersed in a uniform stream, a heavy rod hinged at A will hang at *Pode's angle*  $\theta$ , after L. Pode (1951). Assume the cylinder has normal drag coefficient  $C_{Dn}$  and tangential coefficient  $C_{Dt}$ , related to  $V_n$  and  $V_t$ , respectively. Derive an expression for  $\theta$  as a function of system parameters. Compute  $\theta$  for a steel rod,  $L = 40 \text{ cm}$ ,  $D = 1 \text{ cm}$ , hanging in sea-level air at  $V = 35 \text{ m/s}$ .

**Solution:** For sea-level air, take  $\rho = 1.225 \text{ kg/m}^3$  and  $\mu = 1.78\text{E-}5 \text{ kg/m}\cdot\text{s}$ . The tangential drag force passes right through A, so the moment balance is

$$\sum M_A = F_n \frac{L}{2} - W \frac{L}{2} \cos \theta = C_{Dn} \frac{\rho}{2} (V \sin \theta)^2 DL \frac{L}{2} - (\rho_s - \rho)g \frac{\pi}{4} D^2 L \frac{L}{2} \cos \theta,$$

$$\text{Solve for Pode's angle} \quad \frac{\sin^2 \theta}{\cos \theta} = \frac{(\rho_s - \rho)g(\pi/2)D}{\rho C_{Dn} V^2} \quad \text{Ans. (a)}$$

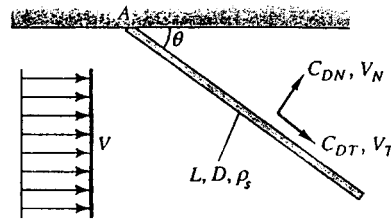
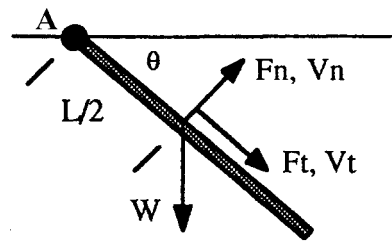


Fig. P7.103



For the numerical data, take  $SG(\text{steel}) = 7.86$ ,  $Re_n \approx 17000$  (laminar),  $C_{Dn} \approx 1.2$ :

$$\frac{\sin^2 \theta}{\cos \theta} = \frac{[7.86(998) - 1.225](9.81)(\pi/2)(0.01)}{(1.225)(1.2)(35)^2} = 0.671, \quad \text{solve } \theta_{\text{Pode}} \approx 44^\circ \quad \text{Ans. (b)}$$

**\*7.104** Suppose that the tractor-trailer truck of Prob. 7.100 is subjected to an unpowered, no-brakes, no-deflector coastdown on a sea-level road. The starting velocity is 65 mi/h. Solve, either analytically or on a computer, for the truck's velocity  $V(t)$  and plot the results until the speed has dropped to 30 mi/h. What is the total coastdown time?

**Solution:** For air at 100-m altitude,  $\rho = 1.112 \text{ kg/m}^3$ . Summing forces along the roadway gives:

$$m_{\text{truck}} \frac{dV}{dt} = -F_{\text{drag}} - F_{\text{roll}} = -C_D \frac{\rho}{2} V^2 A_{\text{frontal}} - C_{\text{roll}} V$$

Separate the variables: 
$$\int_{V_o}^{V_{\text{final}}} \frac{m dV}{aV^2 + C_r V} = - \int_0^{t_{\text{final}}} dt, \quad \text{where } a = C_D \frac{\rho}{2} A_{\text{frontal}}$$

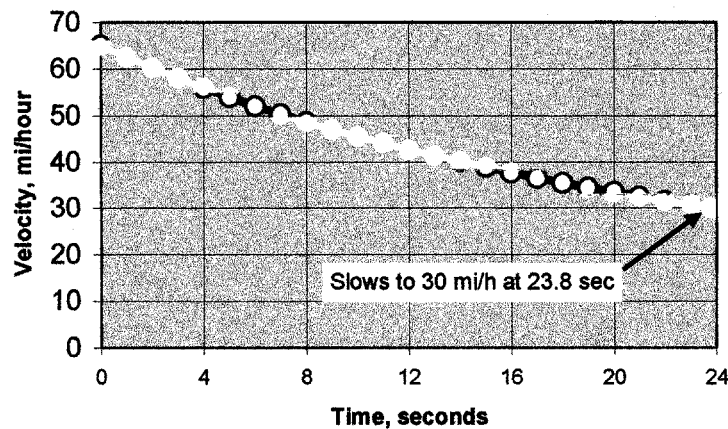
After integration and rearrangement, the solution for deceleration time is:

$$t_{\text{final}} = \frac{m}{C_r} \ln \left[ \frac{V_o}{aV_o + C_r} \frac{aV_{\text{final}} + C_r}{V_{\text{final}}} \right] \quad \text{where } a = C_D \frac{\rho}{2} A_{\text{frontal}}$$

For our data,  $a = 4.804$  and  $t_f = \frac{65000/9.81}{120} \ln \left[ \frac{29.06}{4.804(29.06) + 120} \frac{4.804(13.41) + 120}{13.41} \right]$

or:  $t_{30\text{mi/h}} \approx 23.8 \text{ s}$  Ans.

We converted 65 and 30 mi/h to 29.06 and 13.41 m/s, respectively. A plot of the truck's decelerating velocity is shown below.



**Problem 7.104: Velocity vs. Time**

**7.105** A ship 50 m long, with a wetted area of  $800 \text{ m}^2$ , has the hull shape of Fig. 7.19, with no bow or stern bulbs. Total propulsive power is 1 MW. For seawater at  $20^\circ\text{C}$ , plot the ship's velocity  $V$  (in knots) versus power  $P$  for  $0 < P < 1 \text{ MW}$ . What is the most efficient setting?

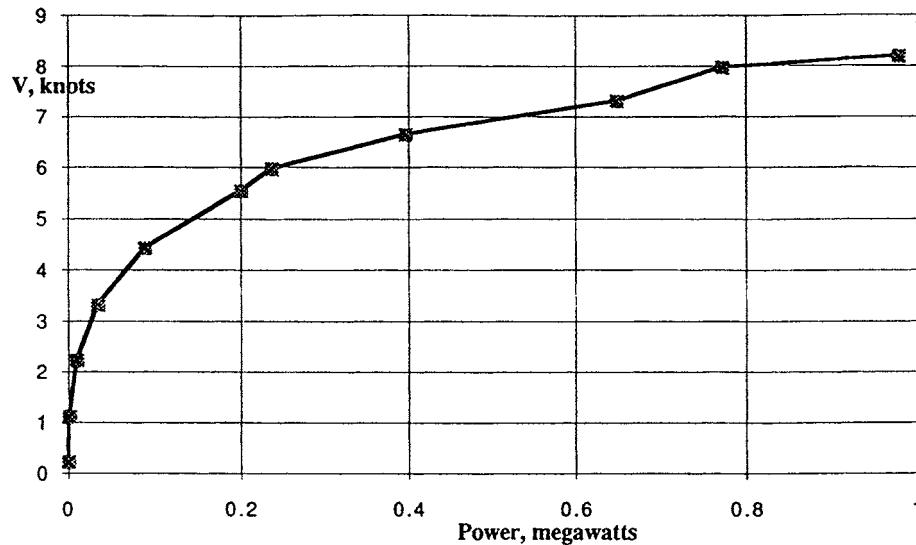
**Solution:** For seawater at  $20^\circ\text{C}$ , take  $\rho = 1025 \text{ kg/m}^3$  and  $\mu = 0.00107 \text{ kg/m}\cdot\text{s}$ . The drag is taken to be the sum of friction and wave drag—which are defined differently:

$$F = F_{\text{frict}} + F_{\text{wave}} = C_{D,\text{frict}} \frac{\rho}{2} V^2 A_{\text{wet}} + C_{D,\text{wave}} \frac{\rho}{2} V^2 L^2,$$

with  $C_{D,\text{wave}}$  from Fig. 7.19 and  $C_{D,\text{frict}} \approx 0.031/\text{Re}_L^{1/7}$  (turbulent flat plate formula)

$$\text{Here, } F = C_{D,\text{frict}} \frac{1025}{2} V^2 (800) + C_{D,\text{wave}} \frac{1025}{2} V^2 (50)^2, \quad \text{with } V \text{ in m/s} \left( 1 \frac{\text{m}}{\text{s}} = 1.94 \text{ kn} \right)$$

Assume different values of  $V$ , calculate friction and wave drag (the latter depending upon the Froude number  $V/\sqrt{gL} = V/\sqrt{[9.81(50)]} \approx 0.0452V(\text{m/s})$ ). Then compute the power in watts from  $P = FV$ , with  $F$  in newtons and  $V$  in m/s. Plot  $P$  versus  $V$  in knots on the graph below. The results show that, below 4 knots, wave drag is negligible and sharp increases in ship speed are possible with small increases in power. Wave drag limits the maximum speed to about 8 knots. There are two good high-velocity, “high slope” regions—at 6 knots and at 7.5 knots—where speed increases substantially with power.



**7.106** A smooth steel ball 1-cm in diameter ( $W \approx 0.04 \text{ N}$ ) is fired vertically at sea level at an initial velocity of  $1000 \text{ m/s}$ . Its drag coefficient is given by Fig. 7.20. Assuming a constant speed of sound ( $343 \text{ m/s}$ ), compute the maximum altitude attained (a) by a simple analytical estimate; and (b) by a computer program.

**Solution:** For sea-level air, take  $\rho = 1.225 \text{ kg/m}^3$  and  $\mu = 1.78\text{E-}5 \text{ kg/m}\cdot\text{s}$ . The initial Mach number is  $\text{Ma}_o = 1000/343 \approx 2.9$ , so we are well out into the region in Fig. 7.20 where  $C_D(\text{sphere}) \approx 1.0 \approx \text{constant}$ . The equation of motion is

$$\Sigma F_z = m \frac{dV}{dt} = -W - C_D \frac{\rho}{2} V^2 \frac{\pi}{4} D^2, \quad \text{or} \quad \frac{dV}{dt} = -g - \left( \frac{\pi \rho C_D D^2}{8m} \right) V^2 \quad (1)$$

With  $m \approx 0.0041 \text{ kg}$  and  $V_o = 1000 \text{ m/s}$ , we compute  $(dV/dt)_{t=0} \approx 12000 \text{ m/s}^2$ ! Hence the (high-drag) ball slows down pretty fast and does not go very high. An approximate analysis, assuming constant drag coefficient, is mathematically the same as in Prob. 7.98:

$$V = V_f \tan \left[ \tan^{-1} \left( \frac{V_o}{V_f} \right) - t \frac{g}{V_f} \right], \quad \text{where} \quad V_f = \sqrt{2W / \{ \rho C_D (\pi/4) D^2 \}}$$

$$\text{For our data,} \quad V_f = \sqrt{2(0.04) / \{ 1.225(1.0)(\pi/4)(0.01)^2 \}} \approx 28.84 \text{ m/s}$$

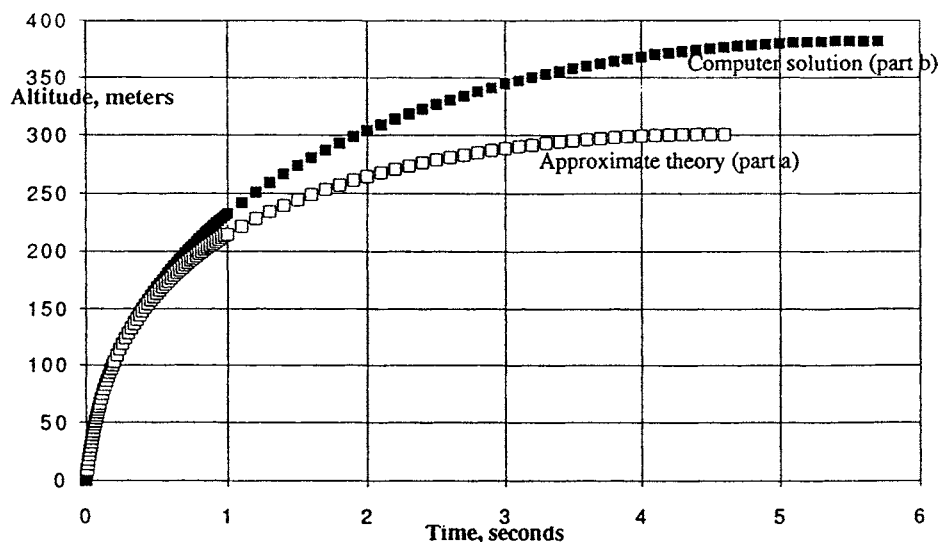
$$\text{Also,} \quad \tan^{-1}(V_o/V_f) = \tan^{-1}(1000/28.84) \approx 1.542 \text{ radians}$$

Maximum altitude occurs when  $V = 0$ , or  $t = (28.84)(1.542)/(9.81) \approx 4.53 \text{ s}$ . The maximum altitude formula is also given in Prob. 7.98:

$$z_{\max} = \frac{m}{\rho C_D A} \ln \left[ 1 + \left( \frac{V_o}{V_f} \right)^2 \right] = \frac{0.0041 \text{ kg}}{1.225(1.0)(\pi/4)(0.01)^2} \ln \left[ 1 + \left( \frac{1000}{28.84} \right)^2 \right]$$

$$z_{\max} \approx 300 \text{ m} \quad \text{Ans. (a)}$$

(b) For a digital computer solution, we let drag coefficient vary with Mach number as in Fig. 7.20 and also let air density and viscosity vary. Equation (1) of this problem is integrated numerically, by Runge-Kutta or whatever. The results are plotted below:



The more exact calculation shows a maximum altitude of  $z_{\max} \approx 380 \text{ m}$  at  $t \approx 5.7 \text{ sec}$ . The discrepancy with the approximate theory is that a substantial part of the final climb occurs for  $\text{Ma} < 1.4$ , for which the drag coefficient decreases as in Fig. 7.20.

**7.107** Repeat Prob. P7.106 if the body shot upward at 1000 m/s is a 9-mm steel bullet ( $W = 0.07 \text{ N}$ ) which approximates the pointed body of revolution in Fig. 7.20.

**Solution:** For sea-level air take  $\rho = 1.225 \text{ kg/m}^3$ . The initial Mach number is  $\text{Ma} = 1000/343 \approx 2.9$ , so we are well out into the region in Fig. 7.20 where  $C_{D,\text{bullet}} \approx 0.4 = \text{constant}$ . Then the analytic solution from part (a) of Prob. P7.106 may be modified with the new data:

$$V_f = \sqrt{\frac{2W}{\rho C_D A}} = \sqrt{\frac{2(0.07 \text{ N})}{(1.225 \text{ kg/m}^3)(0.4)(\pi/4)(0.009 \text{ m})^2}} = 67.02 \text{ m/s}$$

$$\text{also, } \tan^{-1}(V_o/V_f) = \tan^{-1}(1000/67.0) = 1.504 \text{ radians}$$

Then the approximate velocity and maximum altitude are given by the formulas of Prob. P7.106 (originally derived in Prob. P7.98):

$$V = 67.0 \tan\left(1.504 - \frac{9.81}{67.0}t\right), \quad z_{\max}(t = 10.3 \text{ s})$$

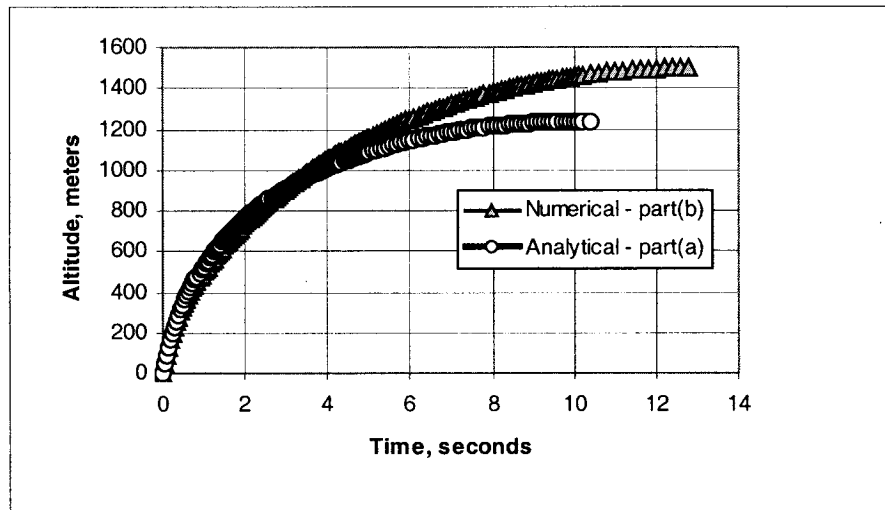
$$\text{whence } z_{\max} = \frac{m}{\rho C_D A} \ln\left[1 + \left(\frac{V_o}{V_f}\right)^2\right]$$

$$z_{\max} = \frac{0.07/9.81}{1.225(0.4)(\pi/4)(0.009)^2} \ln\left[1 + \left(\frac{1000}{67.0}\right)^2\right] = \mathbf{1240 \text{ m}} \quad \text{Ans. (a)}$$

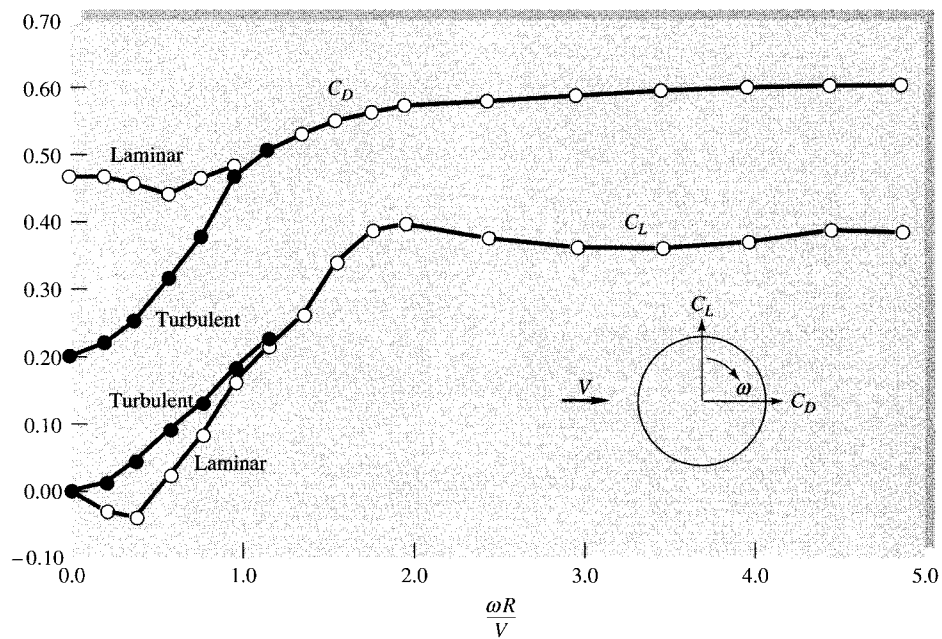
The *bullet* travels 4.1 times as high as the blunt, high-drag sphere of Prob. P7.106.

(b) For a computer solution, let  $C_D$  vary with Mach number as in Fig. 7.20 and also let air density vary. Equation (1) of Prob. P7.106 is integrated numerically, with the results plotted on the next page. The more exact calculation shows a maximum altitude of  $z_{\max} \approx 1500 \text{ m}$  at  $t \approx 12.8 \text{ s}$ . *Ans. (b)*

The more exact result of higher elevation and longer time is due to the considerably lower drag coefficient of the body at subsonic Mach numbers (see Fig. 7.20).



**7.108** The data in Fig. P7.108 are for lift and drag of a *spinning* sphere from Ref. 12, pp. 7–20. Suppose a tennis ball ( $W \approx 0.56$  N,  $D \approx 6.35$  cm) is struck at sea level with initial velocity  $V_0 = 30$  m/s, with “topspin” (front of the ball rotating downward) of 120 rev/sec. If the initial height of the ball is 1.5 m, estimate the horizontal distance travelled before it strikes the ground.



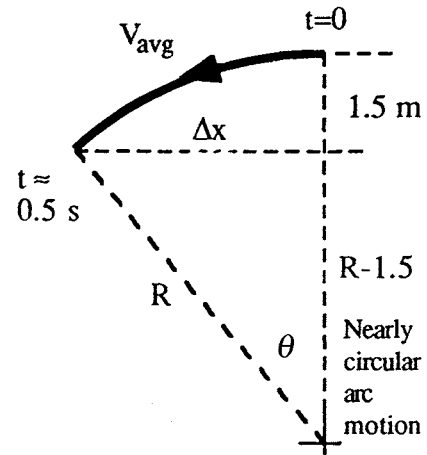
**Fig. P7.108**

**Solution:** For sea-level air, take  $\rho = 1.225 \text{ kg/m}^3$  and  $\mu = 1.78\text{E-}5 \text{ kg/m}\cdot\text{s}$ . For this short distance, the ball travels in nearly a circular arc, as shown at right. From Figure P7.108 we read drag and lift:

$$\omega = 120(2\pi) = 754 \frac{\text{rad}}{\text{s}},$$

$$\frac{\omega R}{V} = \frac{754(0.03175)}{30} \approx 0.80,$$

Read  $C_D \approx 0.47$ ,  $C_L \approx 0.12$



Initially, the accelerations in the horizontal and vertical directions are ( $z$  up,  $x$  to left)

$$a_{x,0} = -\frac{\text{drag}}{m} = -\frac{0.47(1.225/2)(30)^2(\pi/4)(0.0635)^2}{0.56/9.81} \approx -14.4 \text{ m/s}^2$$

$$a_{z,0} = -g - \frac{\text{lift}}{m} = -9.81 - \frac{0.12(1.225/2)(30)^2(\pi/4)(0.0635)^2}{0.56/9.81} \approx -13.5 \text{ m/s}^2$$

The term  $a_x$  serves to slow down the ball from 30 m/s, when hit, to about 24 m/s when it strikes the floor about 0.5 s later. The average velocity is  $(30 + 24)/2 = 27 \text{ m/s}$ . The term  $a_z$  causes the ball to curve in its path, so one can estimate the radius of curvature and the angle of turn for which  $\Delta z = 1.5 \text{ m}$ . Then, finally, one estimates  $\Delta x$  as desired:

$$\frac{V_{\text{avg}}^2}{R} = a_z, \quad \text{or:} \quad R \approx \frac{(27)^2}{13.5} \approx 54 \text{ m}; \quad \theta = \cos^{-1}\left(\frac{54 - 1.5}{54}\right) \approx 13.54^\circ$$

$$\text{Finally, } \Delta x_{\text{ball}} = R \sin \theta = (54) \sin(13.54^\circ) \approx 12.6 \text{ m} \quad \text{Ans.}$$

A more exact numerical integration of the equations of motion (not shown here) yields the result  $\Delta x \approx 13.0 \text{ m}$  at  $t \approx 0.49 \text{ s}$ .

**7.109** Repeat Prob. 7.108 above if the ball is instead struck with “underspin,” that is, with the front of the ball rotating *upward*.

**Solution:** For sea-level air, take  $\rho = 1.225 \text{ kg/m}^3$  and  $\mu = 1.78\text{E-}5 \text{ kg/m}\cdot\text{s}$ . Again, for this short distance, the ball travels in nearly a circular arc, as shown above. This time the

lift acts against gravity, so the ball travels further with approximately the same  $a_x$ . We find the new  $a_z$  and make the same “circular-arc” analysis to find  $R_{\text{new}}$ ,  $\theta$ , and  $\Delta x_{\text{underspin}}$ :

$$a_{x,0} = -14.4 \frac{\text{m}}{\text{s}^2}, \quad a_{z,0} = -9.81 + \frac{0.12(1.225/2)(30)^2(\pi/4)(0.0635)^2}{0.56/9.81} \approx -6.14 \frac{\text{m}}{\text{s}^2}$$

$$V_{\text{avg}} \approx 27 \frac{\text{m}}{\text{s}}, \quad R = \frac{(27)^2}{6.14} \approx 119 \text{ m}; \quad \theta = \cos^{-1}\left(\frac{119-1.5}{119}\right) \approx 9.12^\circ$$

$$\text{Finally, } \Delta x_{\text{underspin}} = (119)\sin(9.12^\circ) \approx \mathbf{18.8 \text{ m}} \quad \text{Ans.}$$

**7.110** A baseball pitcher throws a curveball with an initial velocity of 65 mi/h and a spin of 6500 r/min about a vertical axis. A baseball weighs 0.32 lbf and has a diameter of 2.9 in. Using the data of Fig. P7.108 for turbulent flow, estimate how far such a curveball will have deviated from its straightline path when it reaches home plate 60.5 ft away.

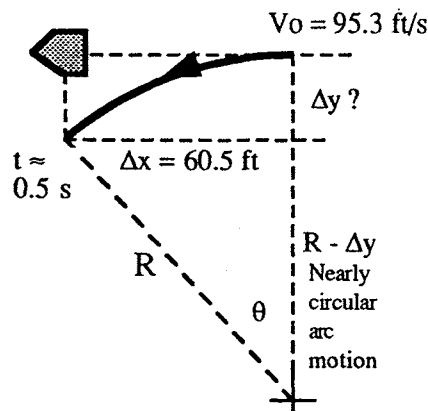


Fig. P7.110

**Solution:** For sea-level air, take  $\rho = 0.00238 \text{ slug/ft}^3$  and  $\mu = 3.72\text{E-}7 \text{ slug/ft}\cdot\text{s}$ . Again, for this short distance, the ball travels in nearly a circular arc, as shown above. However, gravity is *not* involved in this curved *horizontal* path. First evaluate the lift and drag:

$$V_0 = 65 \frac{\text{mi}}{\text{h}} = 95 \frac{\text{ft}}{\text{s}}, \quad \omega = 6500 \left( \frac{2\pi}{60} \right) = 681 \frac{\text{rad}}{\text{s}}, \quad \frac{\omega R}{V} = \frac{681(2.9/24)}{95} \approx 0.86$$

Fig. P7.108: Read  $C_D \approx 0.44$ ,  $C_L \approx 0.17$

The initial accelerations in the  $x$ - and  $y$ -directions are

$$a_{x,0} = -\frac{\text{drag}}{m} = -\frac{0.44(0.00238/2)(95)^2(\pi/4)(2.9/12)^2}{0.32/32.2 \text{ slug}} \approx -22.0 \frac{\text{ft}}{\text{s}^2}$$

$$a_{y,0} = -\frac{\text{lift}}{m} = -\frac{0.17(0.00238/2)(95)^2(\pi/4)(2.9/12)^2}{0.32/32.2} \approx -8.5 \frac{\text{ft}}{\text{s}^2}$$



The ball is in flight about 0.5 sec, so  $a_x$  causes it to slow down to about 85 ft/s, with an average velocity of  $(95 + 85)/2 \approx 90$  ft/s. Then one can use these numbers to estimate R:

$$R = \frac{V_{\text{avg}}^2}{|a_y|} = \frac{(90)^2}{8.5} \approx 954 \text{ ft}; \quad \theta = \sin^{-1}\left(\frac{\Delta x}{R}\right) = \sin^{-1}\left(\frac{60.5}{954}\right) \approx 3.63^\circ$$

$$\text{Finally, } \Delta y_{\text{home plate}} = R(1 - \cos \theta) = 954(1 - \cos 3.63^\circ) \approx \mathbf{1.9 \text{ ft}} \quad \text{Ans.}$$

**7.111** A table tennis ball has a mass of 2.6 g and a diameter of 3.81 cm. It is struck horizontally at an initial velocity of 20 m/s while it is 50 cm above the table, as in Fig. P7.111. For sea-level air, what topspin (as shown), in r/min, will cause the ball to strike the opposite edge of the table, 4 m away? Make an analytical estimate, using Fig. P7.108, and account for the fact that the ball decelerates during flight.

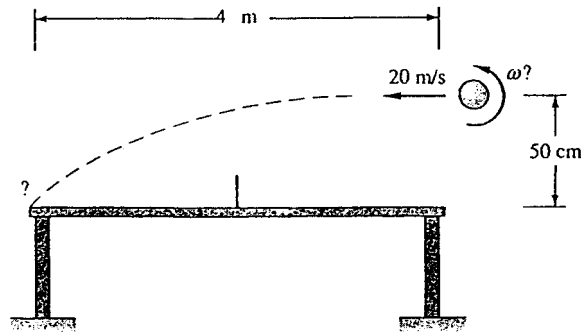


Fig. P7.111

NOTE: The table length is 4 meters.

**Solution:** For sea-level air, take  $\rho = 1.225 \text{ kg/m}^3$  and  $\mu = 1.78\text{E-}5 \text{ kg/m}\cdot\text{s}$ . This problem is **difficult** because *the ball is so light and will decelerate greatly* during its trip across the table. For the last time, as in Prob. 7.108, for this short distance, we assume the ball travels in nearly a *circular arc*, as analyzed there. First, from the geometry of the table,  $\Delta x = 4 \text{ m}$ ,  $\Delta z = 0.5 \text{ m}$ , the required radius of curvature is known:

$$R(1 - \cos \theta) = 0.5 \text{ m}; \quad R \sin \theta = 4 \text{ m}; \quad \text{solve for } R = 16.25 \text{ m}, \quad \theta = 14.25^\circ$$

Then the centripetal acceleration should be estimated from R and the average velocity during the flight. Estimate, from Fig. P7.108, that  $C_D \approx 0.5$ . Then compute

$$a_{x,o} = -\frac{\text{drag}}{\text{mass}} = -\frac{0.5(1.225/2)(20)^2(\pi/4)(0.0381)^2}{0.0026} = -53 \frac{\text{m}}{\text{s}^2}$$

This reduces the ball speed from 20 m/s to about 12 m/s during the 0.25-s flight. Taking our average velocity as  $(20 + 12)/2 \approx 16$  m/s, we compute the vertical acceleration:

$$a_{z,avg} = \frac{V_{avg}^2}{R} = \frac{(16)^2}{16.25} = 15.75 \frac{\text{m}}{\text{s}^2} = 9.81 + \frac{C_L(1.225/2)(16)^2(\pi/4)(0.0381)^2}{0.0026}$$

$$\text{Solve for } C_{L,avg} \approx \mathbf{0.086}$$

From Fig. P7.108, this value of  $C_L$  (probably laminar) occurs at about  $\omega R/V \approx 0.6$ , or  $\omega = 0.6(16)/(0.0381/2) \approx 500$  rad/s  $\approx \mathbf{4800}$  rev/min. *Ans.*

**7.112** A smooth wooden sphere ( $SG = 0.65$ ) is connected by a thin rigid rod to a hinge in a wind tunnel, as in Fig. P7.112. Air at  $20^\circ\text{C}$  and 1 atm flows and levitates the sphere. (a) Plot the angle  $\theta$  versus sphere diameter  $d$  in the range  $1 \text{ cm} \leq d \leq 15 \text{ cm}$ . (b) Comment on the feasibility of this configuration. Neglect rod drag and weight.

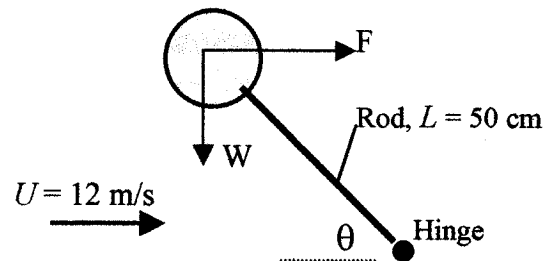


Fig. P7.112

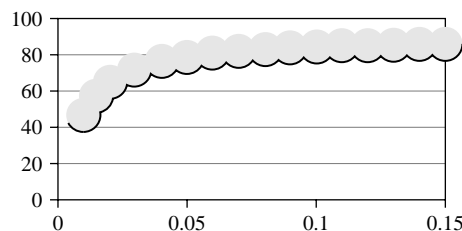
**Solution:** For air, take  $\rho = 1.2 \text{ kg/m}^3$  and  $\mu = 1.8\text{E-}5 \text{ kg/m}\cdot\text{s}$ . If rod drag is neglected and  $L \gg d$ , the balance of moments around the hinge gives:

$$\sum M_{hinge} = 0 = FL \sin \theta - WL \cos \theta, \quad \text{or} \quad \tan \theta = \frac{W}{F} = \frac{\rho_w g (\pi/6) d^3}{(\rho_a/2) C_D V^2 (\pi/4) d^2}$$

$$\text{Input the data: } \tan \theta = \frac{(0.65)(998)(9.81)(\pi/6)d^3}{(1.2/2)C_D(12)^2(\pi/4)d^2} = 49.1 \frac{d}{C_D} \quad \text{with } d \text{ in meters.}$$

We find  $C_D$  from  $Re_d = \rho V d / \mu = (1.2)(12)d / (0.000018) = \mathbf{8E5d}$  (with  $d$  in meters). For  $d = 1 \text{ cm}$ ,  $Re_d = 8000$ , Fig. 7.16b,  $C_D = 0.5$ ,  $\tan \theta = 0.982$ ,  $\theta = 44.5^\circ$ . At the other extreme, for  $d = 15 \text{ cm}$ ,  $Re_d = 120000$ , Fig. 7.16b,  $C_D = 0.5$ ,  $\tan \theta = 14.73$ ,  $\theta = 86.1^\circ$ .

(a) A complete plot is shown at right.  
(b) This is a ridiculous device for either velocity or diameter.



Problem 7.112: Angles vs. Diameter

**7.113** An auto has  $m = 1000$  kg and a drag-area  $C_D A = 0.7$  m<sup>2</sup>, plus constant 70-N rolling resistance. The car coasts without brakes at 90 km/h climbing a hill of 10 percent grade ( $5.71^\circ$ ). How far up the hill will the car come to a stop?

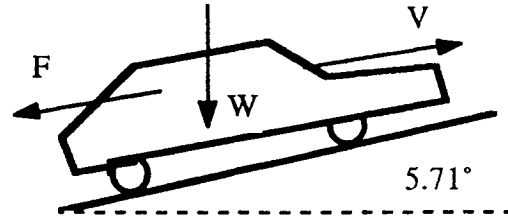


Fig. P7.113

**Solution:** For sea-level air, take  $\rho = 1.225$  kg/m<sup>3</sup> and  $\mu = 1.78E-5$  kg/m·s. If  $x$  denotes uphill, the equation of motion is

$$m \frac{dV}{dt} = -W \sin \theta - F_{\text{rolling}} - C_D A \frac{\rho}{2} V^2, \quad \text{separate the variables and integrate:}$$

$$V = V_f \tan \left[ \tan^{-1} \left( \frac{V_o}{V_f} \right) - t \frac{W \sin \theta + F_r}{m V_f} \right], \quad \text{where } V_f = \sqrt{\frac{W \sin \theta + F_r}{C_D A \rho / 2}}$$

For the particular data of this problem, we evaluate

$$V_f = \sqrt{\frac{9810 \sin 5.71^\circ + 70}{0.7(1.225/2)}} \approx 49.4 \frac{\text{m}}{\text{s}}, \quad \frac{W \sin \theta + F_r}{m V_f} = \frac{9810 \sin 5.71^\circ + 70}{1000(49.4)} \approx 0.0212$$

$$\text{also } \tan^{-1} \left( \frac{25}{49.4} \right) = 0.469 \text{ radians. So, finally, } V \approx 49.4 \tan[0.469 - 0.0212t]$$

The car stops at  $V = 0$ , or  $t_{\text{final}} = 0.469/0.0212 \approx \mathbf{22.1}$  s. The distance to stop is computed by the same formula as in Prob. 7.98:

$$\Delta x_{\text{max}} = \frac{m}{\rho C_D A} \ln \left[ 1 + \left( \frac{V_o}{V_f} \right)^2 \right] = \frac{1000}{1.225(0.7)} \ln \left[ 1 + \left( \frac{25}{49.4} \right)^2 \right] \approx \mathbf{266 \text{ m}} \quad \text{Ans.}$$

**7.114** Suppose the car in Prob. 7.113 above is placed at the top of the hill and released from rest to coast *down* without brakes. What will be the car speed, in km/h, after dropping a vertical distance of 20 m?

**Solution:** Here the car weight *assists* the motion, and, if  $x$  is downhill,

$$m \frac{dV}{dt} = W \sin \theta - F_r - C_D A \frac{\rho}{2} V^2, \quad \text{separate the variables and integrate to get}$$

$$V = V_f \tanh(Ct), \quad \text{where } V_f = \sqrt{\frac{2(W \sin \theta - F_r)}{\rho C_D A}} \quad \text{and} \quad C = \frac{\sqrt{(W \sin \theta - F_r) C_D A \rho / 2}}{m}$$

For our particular data, evaluate

$$V_f = \sqrt{\frac{2(9810 \sin 5.71^\circ - 70)}{1.225(0.7)}} = 46.0 \frac{\text{m}}{\text{s}};$$

$$C = \frac{\sqrt{(9810 \sin 5.71^\circ - 70)(0.7)(1.225/2)}}{1000} = 0.0197 \text{ s}^{-1}$$

We need to know when the car reaches  $\Delta x = (20 \text{ m})/\sin(5.71^\circ) \approx 201 \text{ m}$ . The above expression for  $V(t)$  may be readily integrated:

$$\Delta x = \int_0^t V dt = \frac{V_f}{C} \ln[\cosh(Ct)] = \frac{46.0}{0.0197} \ln[\cosh(0.0197t)] = 201 \text{ m} \quad \text{if } t \approx 21.4 \text{ s}$$

Then, at  $\Delta x = 201 \text{ m}$ ,  $\Delta z = 20 \text{ m}$ ,  $V = 46.0 \tanh[0.0197(21.4)] \approx 18.3 \frac{\text{m}}{\text{s}} = 65.9 \frac{\text{km}}{\text{h}}$  *Ans.*

**7.115** The Cessna *Citation* executive jet weighs 67 kN and has a wing area of 32 m<sup>2</sup>. It cruises at 10 km standard altitude with a lift coefficient of 0.21 and a drag coefficient of 0.015. Estimate (a) the cruise speed in mi/h; and (b) the horsepower required to maintain cruise velocity.

**Solution:** At 10 km standard altitude (Table A-6) the air density is 0.4125 kg/m<sup>3</sup>.  
(a) The cruise speed is found by setting lift equal to weight:

$$\text{Lift} = 67000 \text{ N} = C_L \frac{\rho}{2} V^2 A_{\text{wing}} = 0.21 \left( \frac{0.4125 \text{ kg/m}^3}{2} \right) V^2 (32 \text{ m}^2),$$

$$\text{Solve } V = 220 \frac{\text{m}}{\text{s}} = 492 \frac{\text{mi}}{\text{h}} \quad \text{Ans. (a)}$$

(b) With speed known, the power is found from the drag:

$$\text{Power} = F_{\text{drag}} V = \left( C_D \frac{\rho}{2} V^2 A \right) V = \left\{ 0.015 \left( \frac{0.4125}{2} \right) (220)^2 (32) \right\} (220)$$

$$= 1.05 \text{ MW} = 1410 \text{ hp} \quad \text{Ans. (b)}$$

**7.116** An airplane weighs 180 kN and has a wing area of 160 m<sup>2</sup> and a mean chord of 4 m. The airfoil properties are given by Fig. 7.25. If the plane is designed to land at  $V_o = 1.2V_{\text{stall}}$ , using a split flap set at 60°, (a) What is the proper landing speed in mi/h? (b) What power is required for takeoff at the same speed?

**Solution:** For air at sea level,  $\rho \approx 1.225 \text{ kg/m}^3$ . From Fig. 7.24 with the flap,  $C_{L,\max} \approx 1.75$  at  $\alpha \approx 6^\circ$ . Compute the stall velocity:

$$V_{\text{stall}} = \sqrt{\frac{2W}{\rho C_{L,\max} A_p}} = \sqrt{\frac{2(180000 \text{ N})}{(1.225 \text{ kg/m}^3)(1.75)(160 \text{ m}^2)}} = 32.4 \frac{\text{m}}{\text{s}}$$

$$\text{Then } V_{\text{landing}} = 1.2V_{\text{stall}} = \mathbf{38.9 \frac{m}{s}} \quad \text{Ans. (a)}$$

$$C_L = \frac{C_{L,\max}}{(V_{\text{land}}/V_{\text{stall}})^2} = \frac{1.75}{(1.2)^2} = 1.22$$

For take-off at the same speed of 38.9 m/s, we need a drag estimate. From Fig. 7.25 *with* a split flap,  $C_{D\infty} \approx 0.04$ . We don't have a theory for induced drag with a split flap, so we just go along with the usual finite wing theory, Eq. (7.71). The aspect ratio is  $b/c = (40 \text{ m})/(4 \text{ m}) = 10$ .

$$C_D = C_{D\infty} + \frac{C_L^2}{\pi AR} = 0.04 + \frac{(1.22)^2}{\pi(10)} = 0.087,$$

$$F_{\text{drag}} = (0.087) \left( \frac{1.225}{2} \right) (38.9)^2 (160) = 12900 \text{ N}$$

$$\text{Power required} = FV = (12900 \text{ N})(38.9 \text{ m/s}) = 501000 \text{ W} = \mathbf{672 \text{ hp}} \quad \text{Ans. (b)}$$

**7.117** Suppose the airplane of Prob. 7.116 takes off at sea level without benefit of flaps and with constant lift coefficient and take-off speed of 100 mi/h. (a) Estimate the take-off distance if the thrust is 10 kN. (b) How much thrust is needed to make the take-off distance 1250 m?

**Solution:** For air at sea level,  $\rho = 1.225 \text{ kg/m}^3$ . Convert  $V = 100 \text{ mi/h} = 44.7 \text{ m/s}$ . From Fig. 7.25, with no flap, read  $C_{D\infty} \approx 0.006$ . Compute the lift and drag coefficients:

$$C_L = \frac{2W}{\rho V^2 A_p} = \frac{2(180000 \text{ N})}{(1.225 \text{ kg/m}^3)(44.7 \text{ m/s})^2 (160 \text{ m}^2)} = 0.919 \text{ (assumed constant)}$$

$$C_D = C_{D\infty} + \frac{C_L^2}{\pi AR} = 0.006 + \frac{(0.919)^2}{\pi(10)} = 0.0329$$

The take-off drag is  $D_o = C_D(\rho/2)V^2 A_p = (0.0329)(1.225/2)(44.7)^2(160) = 6440 \text{ N}$ . From Ex. 7.8,

$$S_o = \frac{m}{2K} \ln \left( \frac{T}{T - D_o} \right), \quad K = C_D(\rho/2)A_p = (0.0329)(1.225/2)(160) = 3.22 \text{ kg/m}$$

$$\text{Then } S_o = \frac{(180000/9.81) \text{ kg}}{2(3.22 \text{ kg/m})} \ln \left( \frac{10000 \text{ N}}{10000 \text{ N} - 6440 \text{ N}} \right) = \mathbf{2940 \text{ m}} \quad \text{Ans. (a)}$$

(b) To decrease this take-off distance to 1250 m, we need more thrust, computed as follows:

$$S_o = 1250 \text{ m} = \frac{(180000/9.81) \text{ kg}}{2(3.22 \text{ kg/m})} \ln \left( \frac{T}{T - 6440 \text{ N}} \right), \text{ Solve } \mathbf{T \approx 18100 \text{ N}} \text{ Ans. (b)}$$


---

**7.118** Suppose the airplane of Prob. 7.116 is now fitted with all the best high-lift devices of Fig. 7.28. (a) What is its minimum stall speed in mi/h? (b) Estimate the stopping distance if the plane lands at  $V_o = 1.25V_{\text{stall}}$  with constant  $C_L = 3.0$  and  $C_D = 0.2$  and the braking force is 20% of the weight on the wheels.

**Solution:** For air at sea level,  $\rho = 1.225 \text{ kg/m}^3$ . From Fig. 7.28 read  $C_{L,\text{highest}} \approx 4.0$ .

$$\text{(a) Then } V_{\text{stall}} = \sqrt{\frac{2W}{\rho C_{L,\text{max}} A_p}} = \sqrt{\frac{2(180000 \text{ N})}{(1.225 \text{ kg/m}^3)(4.0)(160 \text{ m}^2)}} = 21.4 \frac{\text{m}}{\text{s}}$$

$$\text{Thus } V_{\text{land}} = 1.25V_{\text{stall}} = 26.8 \frac{\text{m}}{\text{s}} \approx \mathbf{60 \frac{mi}{h}} \text{ Ans. (a)}$$

(b) With constant lift and drag coefficients, we can set up and solve the equation of motion:

$$\sum F_x = m \frac{dV}{dt} = -F_{\text{drag}} - F_{\text{brake}} = -C_D \left( \frac{\rho}{2} \right) V^2 A_p - 0.2(\text{Weight} - \text{Lift})$$

$$\text{or: } \left( \frac{180000}{9.81} \right) \frac{dV}{dt} = -0.2 \left( \frac{1.225}{2} \right) V^2 (160) - 0.2 \left[ 180000 - 3.0 \left( \frac{1.225}{2} \right) V^2 (160) \right]$$

$$\text{Clean this up: } \frac{dV}{dt} = +0.00214V^2 - 1.962$$

We could integrate this twice and calculate  $V = 0$  (stopping) at  $t = 21.5 \text{ s}$  and  $S_{\text{max}} = \mathbf{360 \text{ m}}$ . Or, since we are looking for distance, we could convert  $dV/dt = (1/2)d(V^2)/ds$  to obtain

$$\frac{dV}{dt} = \frac{1}{2} \frac{dV^2}{ds} = 0.00214V^2 - 1.962, \text{ or: } 2 \int_0^{S_{\text{max}}} ds = \int_{V_o^2}^0 \frac{d(V^2)}{0.00214V^2 - 1.962}$$

$$\text{Solution: } S_{\text{max}} = \frac{1}{2(0.00214)} \ln \left[ \frac{1.962}{1.962 - 0.00214(26.8)^2} \right] \approx \mathbf{360 \text{ m}} \text{ Ans. (b)}$$


---

**7.119** An airplane has a mass of 5000 kg, a maximum thrust of 7000 N, and a rectangular wing with aspect ratio 6.0. It takes off at sea level with a 60° split flap as in Fig. 7.25. Assume all lift and drag are due to the *wing*. What is the proper wing size if the take-off distance is to be 1 km?

**Solution:** Once again take sea-level density of  $\rho \approx 1.225 \text{ kg/m}^3$ . With the wing size unknown, practically nothing can be calculated in advance. However, from Fig. 7.25 with the 60° flap, we note that  $C_{L,\max} \approx 1.75$  and  $C_{D\infty} \approx 0.04$ . The rest can at least be listed:

$$S_o = \frac{m}{\rho C_D A} \ln \left[ \frac{T}{T - D_o} \right], \quad \text{where } D_o = \frac{\rho}{2} C_D b c V_o^2, \quad V_o \approx 1.2 V_{\text{stall}} = 1.2 \sqrt{\frac{2W}{\rho C_{L,\max} b c}}$$

$$\text{and we know that } AR = \frac{b}{c} = 6.0, \quad W = 5000(9.81) \text{ N}, \quad T = 7000 \text{ N}.$$

We also know (crudely), that  $C_D \approx C_{D\infty} + C_L^2/(\pi AR)$ . Since  $C_L = 1.75/(1.2)^2 = 1.22$ , we know the drag coefficient,  $C_D \approx 0.04 + (1.22)^2/[6\pi] \approx 0.118$ . Our approach is simply to assume a chord and iterate until the proper take-off distance,  $S_o = 1000 \text{ m}$ , is obtained:

$$\begin{aligned} \text{Guess } c = 2.0 \text{ m}, \quad b = 12.0 \text{ m}, \quad \text{then } V_o = 52.4 \text{ m/s}, \quad D_o = 4777 \text{ N}, \quad S_o = 1648 \text{ m} \\ \text{try } c = 3.0 \text{ m}, \quad b = 18.0 \text{ m}, \quad \text{so } V_o = 34.9 \text{ m/s}, \quad D_o = 4777 \text{ N}, \quad S_o = 733 \text{ m} \end{aligned}$$

This process converges to  $S_o = 1000 \text{ m}$  at  **$c = 2.57 \text{ m}$ ,  $b = 15.4 \text{ m}$**  *Ans.*

Instead of iteration, someone cleverer than I might notice, in advance, that the take-off drag is independent of the wing size, since it is related to the stall speed:

$$D_o = \frac{\rho}{2} C_D b c V_o^2 = \frac{\rho}{2} C_D b c \left[ 1.44 \frac{2W}{\rho C_{L,\max} b c} \right] = 1.44 \frac{C_D}{C_{L,\max}} W = 4777 \text{ N}$$

$$\begin{aligned} \text{Thus } S_o = 1000 \text{ m} = \frac{m}{\rho C_D A} \ln \left( \frac{T}{T - D_o} \right) = \frac{5000}{1.225(0.118)6c^2} \ln \left( \frac{7000}{7000 - 4777} \right), \\ \text{or } \mathbf{c = 2.57 \text{ m}} \end{aligned}$$

**7.120** Show that, if Eqs. (7.70) and (7.71) are valid, the maximum lift-to-drag ratio occurs when  $C_D = 2C_{D\infty}$ . What are  $(L/D)_{\max}$  and  $\alpha$  for a symmetric wing when  $AR = 5.0$  and  $C_{D\infty} = 0.009$ ?

**Solution:** According to our lift and induced-drag approximations, Eqs. (7.70) and (7.71), the lift-to-drag ratio is

$$\frac{L}{D} = \frac{C_L}{C_D} = \frac{C_L}{C_{D\infty} + C_L^2/(\pi AR)}; \quad \text{Differentiate: } \frac{d}{dC_L} \left( \frac{L}{D} \right) = 0 \quad \text{if } C_D = 2C_{D\infty} \quad \text{Ans.}$$

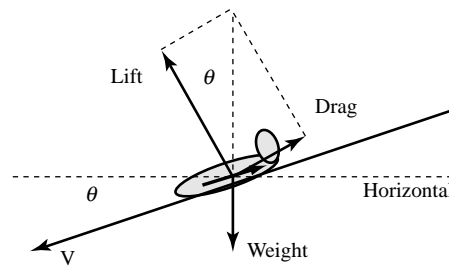
For our numerical example, compute, at maximum  $L/D$ ,

$$AR = 5, \quad C_L = \sqrt{C_{D\infty} \pi AR} = \sqrt{(0.009)\pi(5)} \approx 0.376, \quad C_D = 2C_{D\infty} = 0.018$$

$$\text{Therefore, } L/D|_{\max} = 0.376/0.018 \approx \mathbf{21} \quad \text{Ans.}$$

Also,  $C_L = 0.376 = 2\pi \sin \alpha/[1 + 2/AR] = 2\pi \sin \alpha/[1 + 2/5]$ , solve  $\alpha \approx \mathbf{4.8^\circ}$  Ans.

**7.121** In gliding (unpowered) flight, lift and drag are in equilibrium with the weight. Show, that, with no wind, the craft sinks at an angle  $\tan \theta \approx \text{drag/lift}$ . For a sailplane with  $m = 200$  kg, wing area =  $12 \text{ m}^2$ ,  $AR = 12$ , with an NACA 0009 airfoil, estimate (a) stall speed, (b) minimum gliding angle; (c) the maximum distance it can glide in still air at  $z = 1200$  m.



**Fig. P7.121**

**Solution:** By the geometry of the figure, with no thrust, wind, or acceleration,

$$W = \frac{L}{\cos \theta} = \frac{D}{\sin \theta}, \quad \text{or: } \tan \theta_{\text{glide}} = \frac{D}{L} \quad \text{Ans.}$$

The NACA 0009 airfoil is shown in Fig. 7.25, with  $C_{D\infty} \approx 0.006$ . From Table A-6, at  $z = 1200$  m,  $\rho \approx 1.09 \text{ kg/m}^3$ . Then, as in part (b) of Prob. 7.120 above,

$$\text{at max } \frac{L}{D}, \quad C_L = \sqrt{C_{D\infty} \pi AR} = \sqrt{0.006\pi(12)} = 0.476, \quad \frac{L}{D}|_{\max} = \frac{0.476}{2(0.006)} \approx 39.6$$

$$\text{Thus } \tan \theta_{\min} = 1/39.6 \quad \text{or} \quad \theta_{\min} \approx \mathbf{1.45^\circ} \quad \text{Ans. (b)}$$

Meanwhile, from Fig. 7.25,  $C_{L,\max} \approx 1.3$ , so the stall speed at 1200 m altitude is

$$V_{\text{stall}} = \sqrt{\frac{2W}{\rho C_{L,\max} A}} = \sqrt{\frac{2(200)(9.81)}{1.09(1.3)(12)}} \approx \mathbf{15.2} \frac{\text{m}}{\text{s}} \quad \text{Ans. (a)}$$

With  $\theta_{\min} = 1.45^\circ$  and  $z = 1200$  m, the craft can glide  $1200/\tan(1.45^\circ) \approx \mathbf{47 \text{ km}}$  Ans. (c).



**7.122** A boat of mass 2500 kg has two hydrofoils, each of chord 30 cm and span 1.5 meters, with  $C_{L,max} = 1.2$  and  $C_{D\infty} = 0.08$ . Its engine can deliver 130 kW to the water. For seawater at 20°C, estimate (a) the minimum speed for which the foils support the boat, and (b) the maximum speed attainable.

**Solution:** For seawater at 20°C, take  $\rho = 1025 \text{ kg/m}^3$  and  $\mu = 0.00107 \text{ kg/m}\cdot\text{s}$ . With two foils, total planform area is  $2(0.3 \text{ m})(1.5 \text{ m}) = 0.9 \text{ m}^2$ . Thus the stall speed is

$$V_{\min} = \sqrt{\frac{2W}{\rho C_{L,max} A}} = \sqrt{\frac{2(2500)(9.81)}{1025(1.2)(0.9)}} \approx 6.66 \frac{\text{m}}{\text{s}} \approx (13 \text{ knots}) \quad \text{Ans. (a)}$$

Given  $AR = 1.5/0.3 = 5.0$ . At any speed during lifting operation ( $V > V_{\min}$ ), the lift and drag coefficients, from Eqs. (7.70) and (7.71), are

$$C_L = \frac{2W}{\rho AV^2} = \frac{2(2500)(9.81)}{1025(0.9)V^2} = \frac{53.2}{V^2};$$

$$C_D = C_{D\infty} + \frac{C_L^2}{\pi AR} = 0.08 + \frac{(53.2/V^2)^2}{\pi(5.0)} = 0.08 + \frac{180.0}{V^4}$$

$$\text{Power} = DV = \left(0.08 + \frac{180}{V^4}\right) \left(\frac{1025}{2}\right) V^2 (0.9)V = 130 \text{ hp} \times 745.7 = 96900 \text{ W}$$

$$\text{Clean up and rearrange: } V^4 - 2627V + 2250 = 0,$$

$$\text{Solve } V_{\max} \approx 13.5 \frac{\text{m}}{\text{s}} \approx 26 \text{ kn} \quad \text{Ans. (b)}$$

Three other roots: 2 *imaginary* and  $V_4 = 0.86 \text{ m/s}$  (impossible, below stall)

**7.123** In prewar days there was a controversy, perhaps apocryphal, about whether the bumblebee has a legitimate aerodynamic right to fly. The average bumblebee (*Bombus terrestris*) weighs 0.88 g, with a wing span of 1.73 cm and a wing area of  $1.26 \text{ cm}^2$ . It can indeed fly at 10 m/s. Using fixed-wing theory, what is the lift coefficient of the bee at this speed? Is this reasonable for typical airfoils?

**Solution:** Assume sea-level air,  $\rho = 1.225 \text{ kg/m}^3$ . Assume that the bee's wing is a low-aspect-ratio airfoil and use Eqs. (7.68) and (7.72):

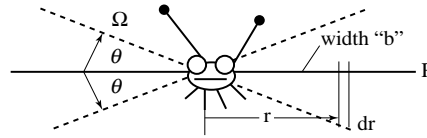
$$AR = \frac{b^2}{A_p} = \frac{(1.73 \text{ cm})^2}{1.26 \text{ cm}^2} = 2.38; \quad C_L = \frac{2W}{\rho V^2 A_p} = \frac{2(0.88\text{E-}3)(9.81)}{1.225(10)^2(1.26\text{E-}4)} \approx 1.12$$

This looks unreasonable,  $C_L \rightarrow C_{L,max}$  and the bee could not fly *slower* than 10 m/s.

Even if this high lift coefficient were possible, the angle of attack would be unrealistic:

$$C_L = 1.12 = \frac{2\pi \sin \alpha}{1 + 2/AR}, \quad \text{with } AR = 2.38, \quad \text{solve for } \alpha \approx 19^\circ \quad (\text{too high, } > \alpha_{\text{stall}})$$

**7.124** The bumblebee can hover at zero speed by flapping its wings. Using the data of Prob. 7.123, devise a theory for flapping wings where the downstroke approximates a short flat plate normal to the flow (Table 7.3)



and the upstroke is feathered at nearly zero drag. How many flaps per second of such a model wing are needed to support the bee's weight? (Actual measurements of bees show a flapping rate of 194 Hz.)

**Solution:** Any "theory" one comes up with might be crude. As shown in the figure, let the wings flap sinusoidally, between  $\pm\theta_0$ , that is,  $\theta = \theta_0 \cos \Omega t$ . Let the upstroke be feathered (zero force), and let the downstroke be strong enough to create a total upward force of  $0.75 W$  on each wing—to compensate for zero lift during upstroke. Assume a short flat plate (Table 7.3),  $C_D \approx 1.2$ . Then, on each strip  $dr$  of wing, the elemental drag force is

$$dF = \frac{\rho}{2} C_D V^2 b dr, \quad \text{where } V = r \frac{d\theta}{dt} = r \Omega \theta_0 \sin(\Omega t)$$

$$F = \int_0^R \frac{\rho}{2} C_D (r \Omega \theta_0 \sin \Omega t)^2 b dr = \frac{\rho}{6} C_D \Omega^2 \theta_0^2 b R^3 [\sin^2 \Omega t]_{\text{avg}} \approx 0.75 W$$

$$\text{Assume full flapping: } \theta_0 = \frac{\pi}{2} \quad \text{and} \quad [\sin^2 \Omega t]_{\text{avg}} \approx \frac{1}{2}$$

$$\text{Evaluate } F = 0.75(0.00088)(9.81) \approx \frac{1.225}{12}(1.2)\Omega^2 \left(\frac{\pi}{2}\right)^2 (0.00728)(0.00865)^3$$

$$\text{Solve for } \Omega \approx 2132 \text{ rad/s} \div 2\pi \approx \mathbf{340 \text{ rev/s}} \quad \text{Ans.}$$

This is about 75% higher than the measured value  $\Omega_{\text{bee}} \approx 194 \text{ Hz}$ , but it's a crude theory!

**7.125** In 2001, a commercial aircraft lost all power while flying at 33,000 ft over the open Atlantic Ocean, about 60 miles from the Azores Islands. The pilots, with admirable skill, put the plane into a shallow glide and successfully landed in the Azores. Assume

that the airplane satisfies Eqs. (7.70) and (7.71), with  $AR = 7$ ,  $C_{d\infty} = 0.02$ , and a symmetric airfoil. Estimate its optimum glide distance with a mathematically perfect pilot.

**Solution:** From Problem P7.120, the maximum lift-to-drag ratio occurs when  $C_d = 2C_{d\infty} = 2(0.02) = 0.04$  in the present case. Accordingly, for maximum  $L/D$  ratio, the lift coefficient is  $C_L = [C_{d\infty}\pi AR]^{1/2} = [0.02\pi(7)]^{1/2} = 0.663$ . From Prob. 7.121, the glide angle of an unpowered aircraft is such that  $\tan\theta = \text{drag/lift} = C_d/C_L$ . Thus, the pilots' optimum glide is:

$$\tan \theta_{\min} = \frac{\text{Drag}}{\text{Lift}} \Big|_{\min} = \frac{0.04}{0.663} = \frac{1}{16.6} = \frac{33000 \text{ ft}}{\text{Glide distance}},$$

or **Glide** = 547000 ft  $\approx$  **104 miles** *Ans.*

---

**FUNDAMENTALS OF ENGINEERING EXAM PROBLEMS: Answers**

FE7.1 A smooth 12-cm-diameter sphere is immersed in a stream of 20°C water moving at 6 m/s. The appropriate Reynolds number of this sphere is

- (a) 2.3E5 (b) **7.2E5** (c) 2.3E6 (d) 7.2E6 (e) 7.2E7

FE7.2 If, in Prob. FE7.1, the drag coefficient based on frontal area is 0.5, what is the drag force on the sphere?

- (a) 17 N (b) 51 N (c) **102 N** (d) 130 N (e) 203 N

FE7.3 If, in Prob. FE7.1, the drag coefficient based on frontal area is 0.5, at what terminal velocity will an aluminum sphere (SG = 2.7) fall in still water?

- (a) **2.3 m/s** (b) 2.9 m/s (c) 4.6 m/s (d) 6.5 m/s (e) 8.2 m/s

FE7.4 For flow of sea-level standard air at 4 m/s parallel to a thin flat plate, estimate the boundary-layer thickness at  $x = 60$  cm from the leading edge:

- (a) 1.0 mm (b) 2.6 mm (c) 5.3 mm (d) **7.5 mm** (e) 20.2 mm

FE7.5 In Prob. FE7.4, for the same flow conditions, what is the wall shear stress at  $x = 60$  cm from the leading edge?

- (a) 0.053 Pa (b) 0.11 Pa (c) **0.016 Pa** (d) 0.32 Pa (e) 0.64 Pa

FE7.6 Wind at 20°C and 1 atm blows at 75 km/h past a flagpole 18 m high and 20 cm in diameter. The drag coefficient based upon frontal area is 1.15. Estimate the wind-induced bending moment at the base of the pole.

- (a) **9.7 kN·m** (b) 15.2 kN·m (c) 19.4 kN·m (d) 30.5 kN·m (e) 61.0 kN·m

FE7.7 Consider wind at 20°C and 1 atm blowing past a chimney 30 m high and 80 cm in diameter. If the chimney may fracture at a base bending moment of 486 kN·m, and its drag coefficient based upon frontal area is 0.5, what is the approximate maximum allowable wind velocity to avoid fracture?

- (a) 50 mi/h (b) 75 mi/h (c) 100 mi/h (d) 125 mi/h (e) **150 mi/h**

FE7.8 A dust particle of density 2600 kg/m<sup>3</sup>, small enough to satisfy Stokes drag law, settles at 1.5 mm/s in air at 20°C and 1 atm. What is its approximate diameter?

- (a) 1.8 μm (b) 2.9 μm (c) **4.4 μm** (d) 16.8 μm (e) 234 μm

FE7.9 An airplane has a mass of 19,550 kg, a wing span of 20 m, and an average wind chord of 3 m. When flying in air of density 0.5 kg/m<sup>3</sup>, its engines provide a thrust of 12 kN against an overall drag coefficient of 0.025. What is its approximate velocity?

- (a) 250 mi/h (b) 300 mi/h (c) 350 mi/h (d) **400 mi/h** (e) 450 mi/h

FE7.10 For the flight conditions of the airplane in Prob. FE7.9 above, what is its approximate lift coefficient?

- (a) 0.1 (b) 0.2 (c) 0.3 (d) **0.4** (e) 0.5

## COMPREHENSIVE PROBLEMS

**C7.1** Jane wants to estimate the drag coefficient of herself on her bicycle. She measures the projected frontal area to be  $0.40 \text{ m}^2$  and the rolling resistance to be  $0.80 \text{ N}\cdot\text{s}/\text{m}$ . Jane coasts down a hill with a constant  $4^\circ$  slope. The bike mass is  $15 \text{ kg}$ , Jane's mass is  $80 \text{ kg}$ . She reaches a terminal speed of  $14 \text{ m/s}$  down the hill. Estimate the aerodynamic drag coefficient  $C_D$  of the rider and bicycle combination.

**Solution:** For air take  $\rho \approx 1.2 \text{ kg}/\text{m}^3$ . Let  $x$  be down the hill. Then a force balance is

$$\sum F_x = 0 = mg \sin \phi - F_{\text{drag}} - F_{\text{rolling}},$$

$$\text{where } F_{\text{drag}} = C_D \frac{\rho}{2} V^2 A, \quad F_{\text{rolling}} = C_{RR} V$$

Solve for, and evaluate, the drag coefficient:

$$C_D = \frac{mg \sin \phi - C_{RR} V}{(1/2) \rho V^2 A} = \frac{95(9.81) \sin 4^\circ - 0.8(14)}{(1/2)(1.2)(14)^2(0.4)} \approx \mathbf{1.14} \quad \text{Ans.}$$

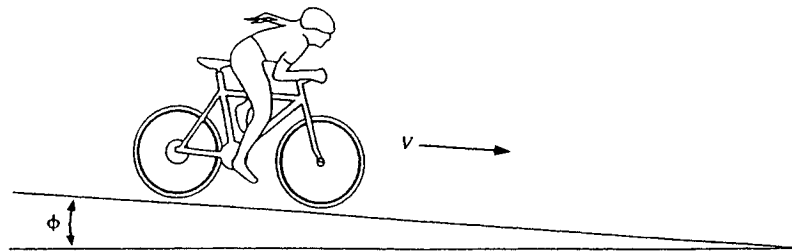


Fig. C7.1

**C7.2** Air at  $20^\circ\text{C}$  and  $1 \text{ atm}$  flows at  $V_{\text{avg}} = 5 \text{ m/s}$  between long, smooth parallel heat-exchanger plates  $10 \text{ cm}$  apart, as shown below. It is proposed to add a number of widely spaced  $1\text{-cm}$ -long thin ‘interrupter’ plates to increase the heat transfer, as shown. Although the channel flow is turbulent, the boundary layer over the interrupter plates is laminar. Assume all plates are  $1 \text{ m}$  wide into the paper. Find (a) the pressure drop in  $\text{Pa}/\text{m}$  without the small plates present. Then find (b) the number of small plates, per meter of channel length, which will cause the overall pressure drop to be  $10 \text{ Pa}/\text{m}$ .

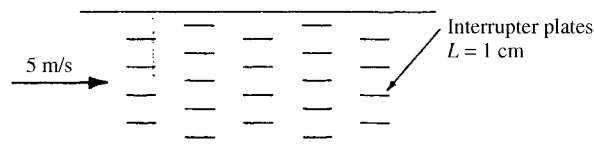


Fig. C7.2

**Solution:** For air, take  $\rho = 1.2 \text{ kg/m}^3$  and  $\mu = 1.8\text{E-}5 \text{ kg/m}\cdot\text{s}$ . (a) For wide plates, the hydraulic diameter is  $D_h = 2h = 20 \text{ cm}$ . The Reynolds number, friction factor, and pressure drop for the bare channel (no small plates) is:

$$Re_{D_h} = \frac{\rho V_{avg} D_h}{\mu} = \frac{(1.2)(5.0)(0.2)}{1.8\text{E-}5} = 66,700 \text{ (turbulent)}$$

$$f_{Moody,smooth} \approx 0.0196$$

$$\Delta p_{bare} = f \frac{L}{D_h} \frac{\rho}{2} V_{avg}^2 = (0.0196) \left( \frac{1.0 \text{ m}}{0.2 \text{ m}} \right) \left( \frac{1.2}{2} \right) (5.0)^2 = \mathbf{1.47 \frac{Pa}{m}} \quad \text{Ans. (a)}$$

Each small plate (neglecting the wake effect if the plates are in line with each other) has a laminar Reynolds number:

$$Re_L = \frac{\rho V_{avg} L_{plate}}{\mu} = \frac{(1.2)(5.0)(0.01)}{1.8\text{E-}5} = \mathbf{3333} < 5E5, \quad \therefore \text{laminar}$$

$$C_{D,laminar} = \frac{1.328}{\sqrt{Re_L}} = \frac{1.328}{\sqrt{3333}} \approx 0.0230$$

$$F_{1plate} = C_D \frac{\rho}{2} V_{avg}^2 A_{2sides} = (0.0230) \left( \frac{1.2}{2} \right) (5.0)^2 (2 \times 0.01 \times 1) = 0.0069 \frac{\text{N}}{\text{plate}}$$

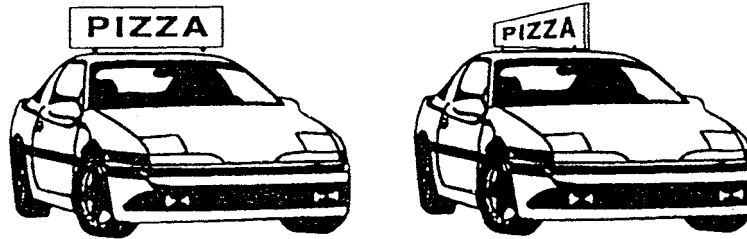
Each plate force must be supported by the channel walls. The effective pressure drop will be the bare wall pressure drop (assumed unchanged) plus the sum of the interrupter-plate forces divided by the channel cross-section area, which is given by  $(h \times 1 \text{ m}) = 0.1 \text{ m}^2$ . The extra pressure drop provided by the plates, for this problem, is  $(10.0 - 1.47) = \mathbf{8.53 \text{ Pa/m}}$ . Therefore we need

$$\text{No. of plates} = \frac{\Delta p_{needed}}{(F/A)_{1plate}} = \frac{8.53 \text{ Pa/m}}{(0.0069 \text{ N/plate})/(0.1 \text{ m}^2)} \approx \mathbf{124 \text{ plates}} \quad \text{Ans. (b)}$$

This is the number of small interrupter plates *needed for each meter of channel length* to build up the pressure drop to 10.0 Pa/m.

**C7.3** A new pizza store needs a delivery car with a sign attached. The sign is 1.5 ft high and 5 ft long. The boss wants to mount the sign normal to the car's motion. His employee, a student of fluid mechanics, suggests mounting it parallel to the motion. (a) Calculate the drag on the *sign alone* at 40 mi/h (58.7 ft/s) in both orientations. (b) The car has a rolling resistance of 40 lbf, a drag coefficient of 0.4, and a frontal area of 40 ft<sup>2</sup>. Calculate the total drag of the car-sign combination at 40 mi/h. (c) Include rolling resistance and calculate the horsepower required in both orientations. (d) If the engine

delivers 10 hp for 1 hour on a gallon of gasoline, calculate the fuel efficiency in mi/gal in both orientations, at 40 mi/h.



**Solution:** For air take  $\rho = 0.00237$  slug/ft<sup>3</sup>. (a) Table 7.3, blunt plate,  $C_D \approx 1.2$ :

$$F_{normal} = C_D \frac{\rho}{2} V^2 A = 1.2 \left( \frac{0.00237}{2} \right) (58.7)^2 (1.5 \times 5.0) \approx \mathbf{37 \text{ lbf}} \quad \text{Ans. (a—normal)}$$

For parallel orientation, take  $m = 3.76E-7$  slug/ft·s. Use flat-plate theory for  $Re_L = 0.00237(58.7)(5.0)/(3.76E-7) = 1.85E6 = \text{transitional—use Eq. (7.49a)}$ :

$$C_D = \frac{0.031}{Re_L^{1/7}} - \frac{1440}{Re_L} = \frac{0.031}{(1.85E6)^{1/7}} - \frac{1440}{1.85E6} \approx 0.00317$$

$$F_{parallel} = 0.00317 \left( \frac{0.00237}{2} \right) (58.7)^2 (1.5 \times 5 \times 2 \text{ sides}) \approx \mathbf{0.19 \text{ lbf}} \quad \text{Ans. (a—parallel)}$$

(b) Add on the drag of the car:

$$F_{car} = C_{D,car} \frac{\rho}{2} V^2 A_{car} = 0.4 \left( \frac{0.00237}{2} \right) (58.7)^2 (40) \approx 65.3 \text{ lbf}$$

$$(1) \text{ sign } \perp: \text{ Total Drag} = 65.3 + 36.7 \approx \mathbf{102 \text{ lbf}} \quad \text{Ans. (b—normal)}$$

$$(2) \text{ sign } //: \text{ Total Drag} = 65.3 + 0.2 \approx \mathbf{65.5 \text{ lbf}} \quad \text{Ans. (b—parallel)}$$

(c) Horsepower required = total force times velocity (include rolling resistance):

$$(1) P_{\perp} = FV = (102 + 40)(58.7) = 8330 \text{ ft}\cdot\text{lbf/s} \div 550 \approx \mathbf{15.1 \text{ hp}} \quad \text{Ans. (c—normal)}$$

$$(2) P_{//} = (65.5 + 40)(58.7) = 6190 \text{ ft}\cdot\text{lbf/s} \div 550 \approx \mathbf{11.3 \text{ hp}} \quad \text{Ans. (b—parallel)}$$

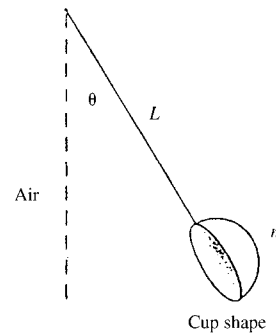
(d) Fuel efficiency:

$$(1) \text{ mpg}_{\perp} = \left( 40 \frac{\text{mi}}{\text{h}} \right) \left( 10 \frac{\text{hp}\cdot\text{h}}{\text{gal}} \right) \left( \frac{1}{15.1 \text{ hp}} \right) \approx \mathbf{26.5 \frac{\text{mi}}{\text{gal}}} \quad \text{Ans. (d—normal)}$$

$$(2) \text{ mpg}_{//} = \left( 40 \frac{\text{mi}}{\text{h}} \right) \left( 10 \frac{\text{hp}\cdot\text{h}}{\text{gal}} \right) \left( \frac{1}{11.3 \text{ hp}} \right) \approx \mathbf{35.4 \frac{\text{mi}}{\text{gal}}} \quad \text{Ans. (d—parallel)}$$

We see that the student is correct, there are fine 25% savings with the sign parallel.

**C7.4** Consider a simple pendulum with an unusual bob shape: a cup of diameter  $D$  whose axis is in the plane of oscillation. Neglect the mass and drag of the rod  $L$ . (a) Set up the differential equation for  $\theta(t)$  and (b) non-dimensionalize this equation. (c) Determine the natural frequency for  $\theta \ll 1$ . (d) For  $L = 1$  m,  $D = 1$  cm,  $m = 50$  g, and air at  $20^\circ\text{C}$  and  $1$  atm, and  $\theta(0) = 30^\circ$ , find (numerically) the time required for the oscillation amplitude to drop to  $1^\circ$ .



**Fig. C7.4**

**Solution:** (a) Let  $L_{\text{eq}} = L + D/2$  be the effective length of the pendulum. Sum forces in the direction of the motion of the bob and rearrange into the basic 2nd-order equation:

$$\sum F_{\text{tangential}} = -mg \sin \theta - C_D \frac{\rho}{2} V_t^2 \frac{\pi}{4} D^2 = m \frac{dV_t}{dt}, \quad \text{where } V_t = L_{\text{eq}} \frac{d\theta}{dt}$$

$$\text{Rearrange: } \ddot{\theta} + K\dot{\theta}^2 + \frac{g}{L_{\text{eq}}} \sin \theta = 0, \quad \text{where } K = \frac{C_D \rho L_{\text{eq}} \pi D^2}{8m} \quad \text{Ans. (a)}$$

Note that  $C_D \approx 0.4$  when moving to the right and about  $1.4$  moving to the left (Table 7.3).

(b) Now  $\theta$  is already dimensionless, so define dimensionless time  $\tau = t(g/L_{\text{eq}})^{1/2}$  and substitute into the differential equation above. We obtain the dimensionless result

$$\frac{d^2\theta}{d\tau^2} + K \left( \frac{d\theta}{d\tau} \right)^2 + \theta = 0 \quad \text{Ans. (b)}$$

Thus the only dimensionless parameter is  $K$  from part (a) above.

(c) For  $\theta \ll 1$ , the term involving  $K$  is neglected, and  $\sin \theta \approx \theta$  itself. We obtain

$$\ddot{\theta} + \omega_n^2 \theta \approx 0, \quad \text{where } \omega_n = \sqrt{\frac{g}{L_{\text{eq}}}} \quad \text{Ans. (c)}$$

Thus the natural frequency is  $(g/L_{\text{eq}})^{1/2}$  just as for the simple drag-free pendulum. Recall that  $L_{\text{eq}} = L + D/2$ . Note again that  $K$  has a different value when moving to the right ( $C_D \approx 0.4$ ) or to the left ( $C_D \approx 1.4$ ).

(d) For the given data,  $\rho_{\text{air}} = 1.2$  kg/m<sup>3</sup>,  $L_{\text{eq}} = L + D/2 = 1.05$  m, and the parameter  $K$  is

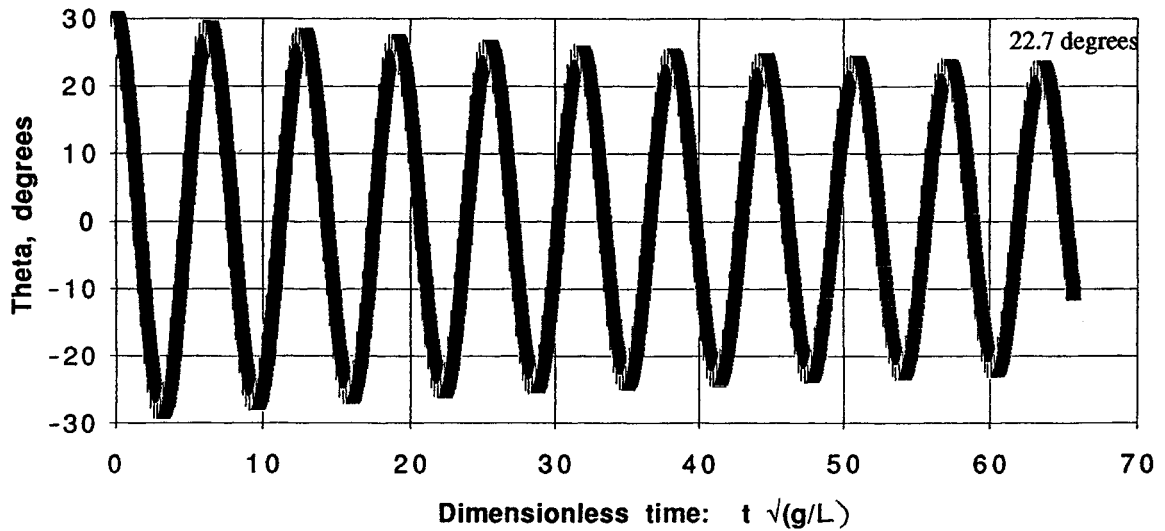
$$\begin{aligned} K &= \frac{C_D (1.2) (1.05) \pi (0.1)^2}{8(0.050)} = 0.099 C_D = 0.0396 \quad (\text{moving to the right}) \\ &= 0.1385 \quad (\text{moving to the left}) \end{aligned}$$



The differential equation from part (b) is then solved for  $\theta(0) = 30^\circ = \pi/6$  radians. The natural frequency is  $(9.81/1.05)^{1/2} = 3.06$  rad/s, with a dimensionless period of  $2\pi$ . Integrate numerically, with Runge-Kutta or MatLab or Excel or whatever, until  $\theta = 1^\circ = \pi/180$  radians. The time-series results are shown in the figure below.

We see that the pendulum is very *lightly damped*—drag forces are only about 1/50th of the weight of the bob. After ten cycles, the amplitude has only dropped to  $22.7^\circ$ —we will never get down to  $1^\circ$  in the lifetime of my computer. The dimensionless period is 6.36, or only 1% greater than the simple drag-free theoretical value of  $2\pi$ .

### Lightly Damped Two-Way-Non-Linear Pendulum



# Chapter 8 • Potential Flow and Computational Fluid Dynamics

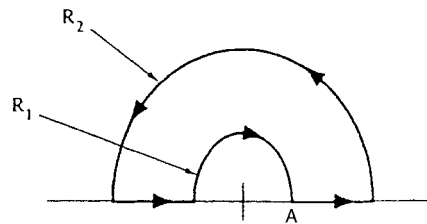
**8.1** Prove that the streamlines  $\psi(r, \theta)$  in polar coordinates, from Eq. (8.10), are orthogonal to the potential lines  $\phi(r, \theta)$ .

**Solution:** The streamline slope is represented by

$$\left. \frac{dr}{r d\theta} \right|_{\text{streamline}} = \frac{v_r}{v_\theta} = \frac{\partial\phi/\partial r}{(1/r)(\partial\phi/\partial\theta)} = \frac{-1}{\left( \frac{dr}{r d\theta} \right)_{\text{potential line}}}$$

Since the  $\psi$ -slope =  $-1/(\phi$ -slope), the two sets of lines are **orthogonal**. *Ans.*

**8.2** The steady plane flow in the figure has the polar velocity components  $v_\theta = \Omega r$  and  $v_r = 0$ . Determine the circulation  $\Gamma$  around the path shown.



**Fig. P8.2**

**Solution:** Start at the inside right corner, point A, and go around the complete path:

$$\Gamma = \oint \mathbf{V} \cdot d\mathbf{s} = 0(R_2 - R_1) + \Omega R_2(\pi R_2) + 0(R_1 - R_2) + \Omega R_1(-\pi R_1)$$

or:  $\Gamma = \pi\Omega(R_2^2 - R_1^2)$  *Ans.*

**8.3** Using cartesian coordinates, show that each velocity component (u, v, w) of a potential flow satisfies Laplace's equation separately if  $\nabla^2\phi = 0$ .

**Solution:** This is true because the order of integration may be changed in each case:

$$\text{Example: } \nabla^2 u = \nabla^2 \left( \frac{\partial\phi}{\partial x} \right) = \frac{\partial}{\partial x} (\nabla^2 \phi) = \frac{\partial}{\partial x} (0) = 0 \quad \text{Ans.}$$

**8.4** Is the function  $1/r$  a legitimate velocity potential in plane polar coordinates? If so, what is the associated stream function  $\psi(r, \theta)$ ?

**Solution:** Evaluation of the laplacian of  $(1/r)$  shows that it is *not* legitimate:

$$\nabla^2\left(\frac{1}{r}\right) = \frac{1}{r} \frac{\partial}{\partial r} \left[ r \frac{\partial}{\partial r} \left( \frac{1}{r} \right) \right] = \frac{1}{r} \frac{\partial}{\partial r} \left[ r \left( -\frac{1}{r^2} \right) \right] = \frac{1}{r^3} \neq 0 \quad \text{Illegitimate} \quad \text{Ans.}$$


---

**8.5** Consider the two-dimensional velocity distribution  $u = -By$ ,  $v = +Bx$ , where  $B$  is a constant. If this flow possesses a stream function, find its form. If it has a velocity potential, find that also. Compute the local angular velocity of the flow, if any, and describe what the flow might represent.

**Solution:** It does have a stream function, because it satisfies continuity:

$$\frac{\partial u}{\partial x} + \frac{\partial v}{\partial y} = 0 + 0 = 0 \text{ (OK);} \quad \text{Thus } u = -By = \frac{\partial \psi}{\partial y} \quad \text{and} \quad v = Bx = -\frac{\partial \psi}{\partial x}$$

$$\text{Solve for } \psi = -\frac{B}{2}(x^2 + y^2) + \text{const} \quad \text{Ans.}$$

It does not have a velocity potential, because it has a non-zero curl:

$$2\omega = \text{curl } \mathbf{V} = \mathbf{k} \left( \frac{\partial v}{\partial x} - \frac{\partial u}{\partial y} \right) = \mathbf{k}[B - (-B)] = 2B\mathbf{k} \neq 0 \quad \text{thus } \phi \text{ does not exist} \quad \text{Ans.}$$

The flow represents solid-body rotation at uniform clockwise angular velocity  $B$ .

---

**8.6** If the velocity potential of a realistic two-dimensional flow is  $\phi = C \ln(x^2 + y^2)^{1/2}$ , where  $C$  is a constant, find the form of the stream function  $\psi(x, y)$ . *Hint:* Try polar coordinates.

**Solution:** Using polar coordinates is certainly an excellent hint! Then the velocity potential translates simply to  $\phi = C \ln(r)$ , which is a line source. Equation (8.12b) also shows that,

$$\text{Eq. (8.12b): } \psi = C\theta = C \tan^{-1} \left( \frac{y}{x} \right) \quad \text{Ans.}$$


---

**8.7** Consider a flow with constant density and viscosity. If the flow possesses a velocity potential as defined by Eq. (8.1), show that it exactly satisfies the full Navier-Stokes equation (4.38). If this is so, why do we back away from the full Navier-Stokes equation in solving potential flows?

**Solution:** If  $\mathbf{V} = \nabla\phi$ , the full Navier-Stokes equation is satisfied identically:

$$\rho \frac{d\mathbf{V}}{dt} = -\nabla p + \rho \mathbf{g} + \mu \nabla^2 \mathbf{V} \quad \text{becomes}$$

$$\rho \left[ \nabla \left( \frac{\partial \phi}{\partial t} \right) + \nabla \left( \frac{V^2}{2} \right) \right] = -\nabla p - \nabla(\rho g z) + \mu \nabla(\nabla^2 \phi), \quad \text{where the last term is } \mathbf{zero}.$$

The viscous (final) term drops out identically for potential flow, and what remains is

$$\frac{\partial \phi}{\partial t} + \frac{V^2}{2} + \frac{p}{\rho} + g z = \text{constant} \quad (\text{Bernoulli's equation})$$

The Bernoulli relation is an exact solution of Navier-Stokes for potential flow. We don't exactly "back away," we need also to solve  $\nabla^2 \phi = 0$  in order to find the velocity potential.

**8.8** For the velocity distribution of Prob. 8.5,  $u = -By$ ,  $v = +Bx$ , evaluate the circulation  $\Gamma$  around the rectangular closed curve defined by  $(x, y) = (1, 1)$ ,  $(3, 1)$ ,  $(3, 2)$ , and  $(1, 2)$ .

**Solution:** Given  $\Gamma = \int \mathbf{V} \cdot d\mathbf{s}$  around the curve, divide the rectangle into (a, b, c, d) pieces as shown:

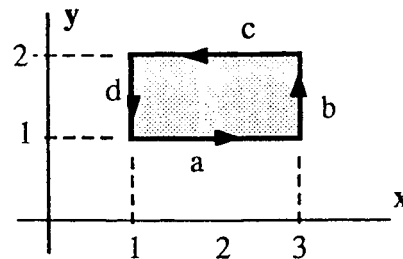


Fig. P8.8

$$\Gamma = \int_a u \, ds + \int_b v \, ds + \int_c u \, ds + \int_d v \, ds = (-B)(2) + (3B)(1) + (2B)(2) + (-B)(1)$$

$$\text{or } \Gamma = +4B \quad \text{Ans.}$$

Since, from Prob. 8.5,  $|\text{curl } \mathbf{V}| = 2B$ , also  $\Gamma = |\text{curl } \mathbf{V}| A_{\text{region}} = (2B)(2) = 4B$ . (Check)

**8.9** Consider the two-dimensional flow  $u = -Ax$ ,  $v = +Ay$ , where  $A$  is a constant. Evaluate the circulation  $\Gamma$  around the rectangular closed curve defined by  $(x, y) = (1, 1)$ ,  $(4, 1)$ ,  $(4, 3)$ , and  $(1, 3)$ . Interpret your result especially *vis-a-vis* the velocity potential.

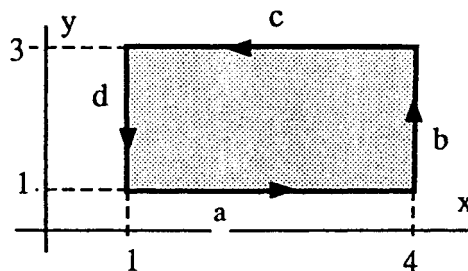


Fig. P8.9

**Solution:** Given  $\Gamma = \int \mathbf{V} \cdot d\mathbf{s}$  around the curve, divide the rectangle into (a, b, c, d) pieces as shown:

$$\begin{aligned} \Gamma &= \int_a^4 u \, dx + \int_b^3 v \, dy + \int_c^4 u \, dx + \int_d^3 v \, dy \\ &= \int_1^4 (-Ax) \, dx + \int_1^3 Ay \, dy + \int_1^4 Ax \, dx + \int_1^3 (-Ay) \, dy = \mathbf{0} \quad \text{Ans.} \end{aligned}$$

The circulation is zero because the flow is **irrotational**:  $\text{curl } \mathbf{V} \equiv \mathbf{0}, \Gamma = \int d\phi \equiv \mathbf{0}$ .

**8.10** A mathematical relation sometimes used in fluid mechanics is the theorem of Stokes [1]

$$\oint_C \mathbf{V} \cdot d\mathbf{s} = \iint_A (\nabla \times \mathbf{V}) \cdot \mathbf{n} \, dA$$

where  $A$  is any surface and  $C$  is the curve enclosing that surface. The vector  $d\mathbf{s}$  is the differential arc length along  $C$ , and  $\mathbf{n}$  is the unit outward normal vector to  $A$ . How does this relation simplify for irrotational flow, and how does the resulting line integral relate to velocity potential?

**Solution:** If  $\mathbf{V} = \nabla\phi$ , we obtain

$$\int_C \nabla\phi \cdot d\mathbf{s} = \iint_A (\nabla \times \nabla\phi) \cdot \mathbf{n} \, dA, \quad \text{or:} \quad \int_C d\phi = 0 = \iint_A 0 \, dA \equiv 0$$

**8.11** A power-plant discharges cooling water through the manifold in Fig. P8.11, which is 55 cm in diameter and 8 m high and is perforated with 25,000 holes 1 cm in diameter. Does this manifold simulate a line source? If so, what is the equivalent source strength  $m$ ?

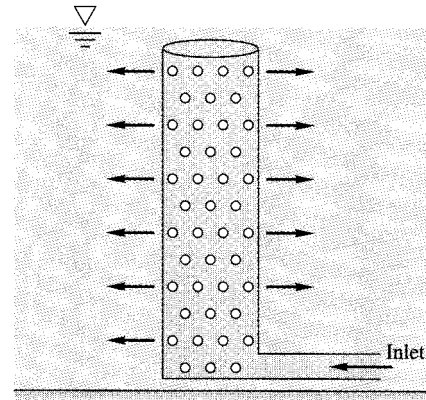


Fig. P8.11

**Solution:** With that many small holes, equally distributed and presumably with equal flow rates, the manifold **does indeed** simulate a line source of strength

$$m = \frac{Q}{2\pi b}, \quad \text{where } b = 8 \text{ m and } Q = \sum_{i=1}^{25000} Q_{\text{hole}} \quad \text{Ans.}$$

**8.12** Consider the flow due to a vortex of strength  $K$  at the origin. Evaluate the circulation from Eq. (8.15) about the clockwise path from  $(a, 0)$  to  $(2a, 0)$  to  $(2a, 3\pi/2)$  to  $(a, 3\pi/2)$  and back to  $(a, 0)$ . Interpret your result.

**Solution:** Break the path up into (1, 2, 3, 4) as shown. Then

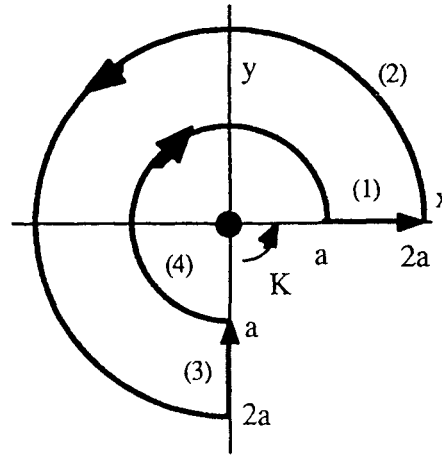


Fig. P8.12

$$\begin{aligned}\Gamma &= \int_{\text{path}} \mathbf{V} \cdot d\mathbf{s} \\ &= \int_{(1)} u ds + \int_{(2)} v_{\theta} ds + \int_{(3)} v ds + \int_{(4)} v_{\theta} ds \\ &= 0 + \int_{(2)} \frac{K}{2a} 2a d\theta + 0 + \int_{(4)} \frac{K}{a} (-a d\theta) = K \left( \frac{3\pi}{2} \right) + K \left( -\frac{3\pi}{2} \right) = 0 \quad \text{Ans.}\end{aligned}$$

There is zero circulation **about all closed paths which do not enclose the origin.**

**8.13** A well-known exact solution to the Navier-Stokes equation (4.38) is the unsteady circulating motion [15]

$$v_{\theta} = \frac{K}{2\pi r} \left[ 1 - \exp\left(-\frac{r^2}{4\nu t}\right) \right] \quad v_r = v_z = 0$$

where  $K$  is a constant and  $\nu$  is the kinematic viscosity. Does this flow have a polar-coordinate stream function and/or velocity potential? Explain. Evaluate the circulation  $\Gamma$  for this motion, plot it versus  $r$  for a given finite time, and interpret compared to ordinary line vortex motion.

**Solution:** Since  $v_{\theta}$  does not depend upon  $\theta$  and since  $v_r = 0$ , this distribution exactly satisfies the continuity equation (4.12b). Therefore **a stream function exists:**

$$\psi = -\int v_{\theta} dr = -\frac{K}{2\pi} \ln(r) + \frac{K}{2\pi} \int \frac{1}{r} \exp\left(-\frac{r^2}{4\nu t}\right) dr$$

(I can't work out the last integral.) *Ans.*

However, the flow is **not irrotational** and therefore not a potential flow:

$$\omega_z = \frac{1}{r} \frac{\partial}{\partial r} (r v_{\theta}) \neq 0 \quad \text{therefore } \phi \text{ does not exist} \quad \text{Ans.}$$

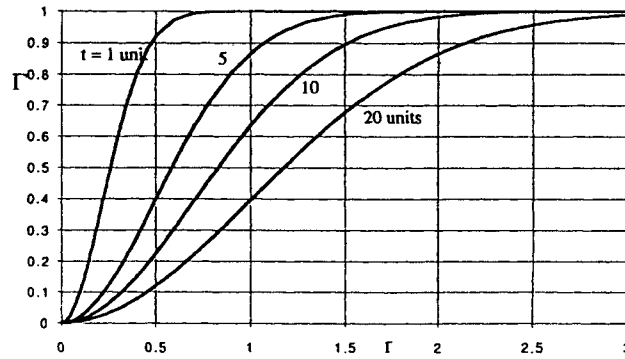


Fig. P8.13

Since we have purely circulating motion, the circulation is easy to compute around a circular path enclosing the origin:

$$\Gamma = \int_0^{2\pi} \mathbf{v}_\theta \mathbf{r} d\theta = K[1 - e^{-r^2/4vt}] \quad \text{Ans.}$$

The distribution of  $\Gamma(r)$  is shown in the figure (in arbitrary units). At  $t = 0$ ,  $\Gamma$  is uniform and represents a potential vortex. As time increases, the vortex decays from the inside out due to viscosity and the circulation in the inner core vanishes.

**8.14** A tornado may be modeled as the circulating flow shown in Fig. P8.14, with  $v_r = v_z = 0$  and  $v_\theta(r)$  such that

$$v_\theta = \begin{cases} \omega r & r \leq R \\ \frac{\omega R^2}{r} & r > R \end{cases}$$

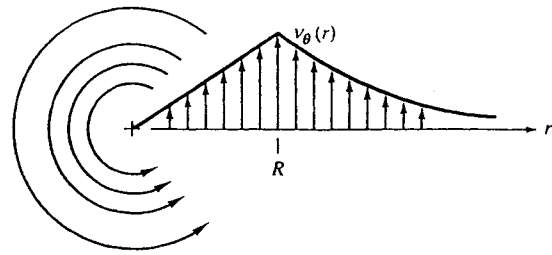


Fig. P8.14

Determine whether this flow pattern is irrotational in either the inner or outer region. Using the  $r$ -momentum equation (D.5) of App. D, determine the pressure distribution  $p(r)$  in the tornado, assuming  $p = p_\infty$  as  $r \rightarrow \infty$ . Find the location and magnitude of the lowest pressure.

**Solution:** The inner region is solid-body **rotation**, the outer region is **irrotational**:

Inner region:  $\Omega_z = \frac{1}{r} \frac{d}{dr}(rv_\theta) = \frac{1}{r} \frac{d}{dr}(r\omega r) = 2\omega = \text{constant} \neq 0 \quad \text{Ans. (inner)}$

Outer region:  $\Omega_z = \frac{1}{r} \frac{d}{dr}(\omega R^2/r) = 0 \quad (\text{irrotational}) \quad \text{Ans. (outer)}$

The pressure is found by integrating the  $r$ -momentum equation (D-5) in the Appendix:

$$\frac{dp}{dr} = \rho v_{\theta}^2/r, \quad \text{or:} \quad p_{\text{outer}} = \int \frac{\rho}{r} \left( \frac{\omega R^2}{r} \right)^2 dr = -\rho \omega^2 R^4 / 2r^2 + \text{constant}$$

when  $r = \infty$ ,  $p = p_{\infty}$ , hence  $p_{\text{outer}} = p_{\infty} - \rho \omega^2 R^4 / (2r^2)$  *Ans.* (outer)

At the match point,  $r = R$ ,  $p_{\text{outer}} = p_{\text{inner}} = p_{\infty} - \rho \omega^2 R^2 / 2$

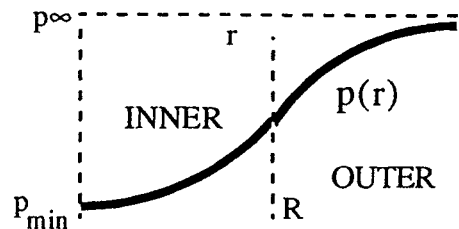
In the inner region, we integrate the radial pressure gradient and match at  $r = R$ :

$$p_{\text{inner}} = \int \frac{\rho}{r} (\omega r)^2 dr = \rho \omega^2 r^2 / 2 + \text{constant}, \quad \text{match to } p(R) = p_{\infty} - \rho \omega^2 R^2 / 2$$

finally,  $p_{\text{inner}} = p_{\infty} - \rho \omega^2 R^2 + \rho \omega^2 r^2 / 2$  *Ans.* (inner)

The minimum pressure occurs at the origin,  
 $r = 0$ :

$$p_{\text{min}} = p_{\infty} - \rho \omega^2 R^2 \quad \text{Ans. (min)}$$



**8.15** A category-3 hurricane on the Saffir-Simpson scale ([www.encyclopedia.com](http://www.encyclopedia.com)) has a maximum velocity of 130 mi/h. Let the match-point radius be  $R = 18$  km (see Fig. P8.14). Assuming sea-level standard conditions at large  $r$ , (a) find the minimum pressure; (b) find the pressure at the match-point; and (c) show that both minimum and match-point pressures are independent of  $R$ .

**Solution:** Convert  $130 \text{ mi/h} = 58.1 \text{ m/s} = \omega R$ . Let  $\rho = 1.22 \text{ kg/m}^3$ . (a) From Prob. 8.14,

$$p_{\text{min}} = p_{\infty} - \rho(\omega R)^2 = 101350 \text{ Pa} - (1.22 \text{ kg/m}^3)(58.1 \text{ m/s})^2 = \mathbf{97200 \text{ Pa}} \quad \text{Ans. (a)}$$

(b) Again from Prob. 8.14, the match pressure only drops half as low as the minimum pressure:

$$p_{\text{match}} = p_{\infty} - \frac{\rho}{2}(\omega R)^2 = 101350 - \frac{1.22}{2}(58.1)^2 = \mathbf{99300 \text{ Pa}} \quad \text{Ans. (b)}$$

(c) We see from above that both  $p_{\text{min}}$  and  $p_{\text{match}}$  have  $R$  in their formulas, but only in conjunction with  $\omega$ . That is, these pressures depend only upon  $V_{\text{max}}$ , wherever it occurs.



**8.16** Consider inviscid stagnation flow  $\psi = Kxy$ , superimposed with a source at the origin of strength  $m$ . Plot the resulting streamlines in the upper-half plane, using the length scale  $(m/K)^{1/2}$ . Give a physical interpretation of the flow pattern.

**Solution:** The sum of a stagnation flow plus a source at the origin is:

$$\psi = Kxy + m\theta \quad \text{Define dimensionless } x^* = x\sqrt{\frac{K}{m}} \text{ and } y^* = y\sqrt{\frac{K}{m}}$$

$$\text{Then we obtain } \frac{\psi}{m} = x^*y^* + \theta, \quad \text{where } \theta = \tan^{-1}\left(\frac{y^*}{x^*}\right)$$

The MATLAB plot is given below: It represents **stagnation flow toward a bump**.

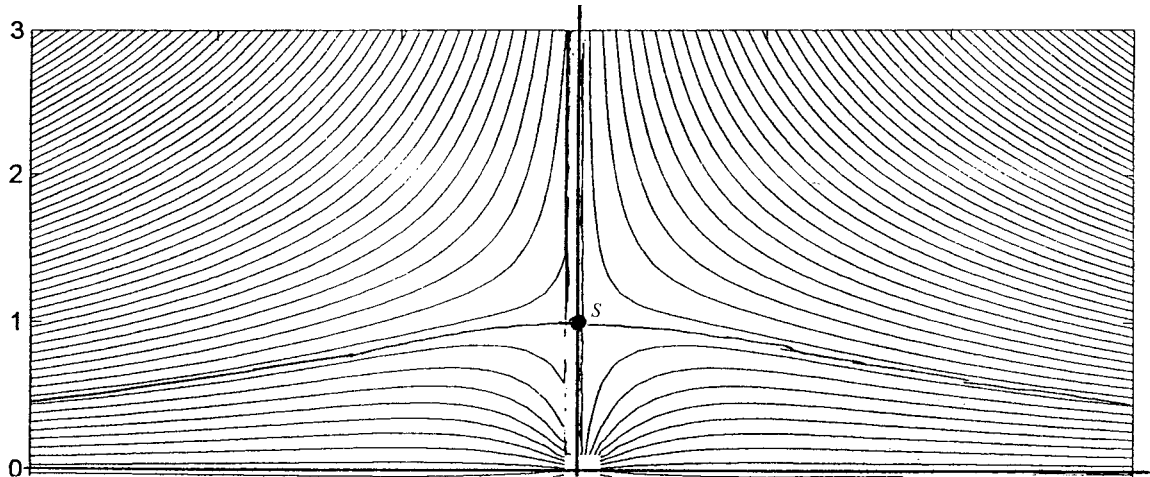


Fig. P8.16

**8.17** Find the position  $(x, y)$  on the upper surface of the half-body in Fig. 8.5a for which the local velocity equals the uniform stream velocity. What should the pressure be at this point?

**Solution:** The surface velocity and surface contour are given by Eq. (8.18):

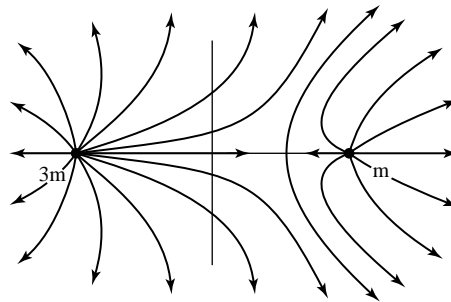
$$V^2 = U_\infty^2 \left( 1 + \frac{a^2}{r^2} + \frac{2a}{r} \cos \theta \right) \quad \text{along the surface } \frac{r}{a} = \frac{\pi - \theta}{\sin \theta}$$

If  $V = U_\infty$ , then  $a^2/r^2 = -2a \cos \theta / r$ , or  $\cos \theta = -a/(2r)$ . Combine with the surface profile above, and we obtain an equation for  $\theta$  alone:  $\tan \theta = -2(\pi - \theta)$ . The final solution is:

$$\theta = 113.2^\circ; \quad r/a = 1.268; \quad \mathbf{x/a = -0.500; \quad y/a = 1.166} \quad \text{Ans.}$$

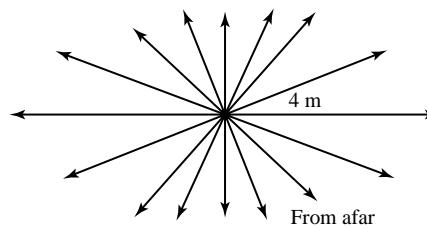
Since the velocity equals  $U_\infty$  at this point, the surface pressure  $\mathbf{p = p_\infty}$ . Ans.

**8.18** Using the graphical method of Fig. 8.4, plot the streamlines and potential lines of the flow due to a line source of strength  $m$  at  $(a, 0)$  plus a line source  $3m$  at  $(-a, 0)$ . What is the flow pattern viewed from afar?

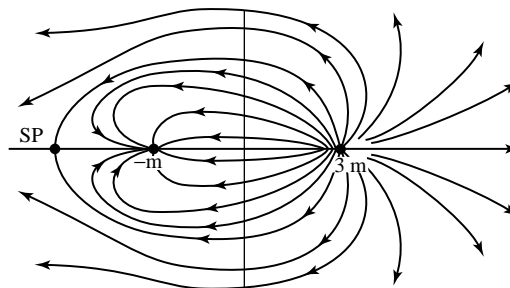


**Fig. P8.18**

**Solution:** The pattern viewed close-up is shown above. The pattern viewed from afar is at right and represents a single source of strength  $4m$ . *Ans.*

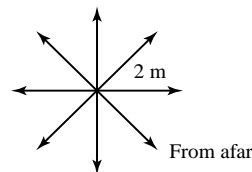


**8.19** Plot the streamlines and potential lines of the flow due to a line source of strength  $3m$  at  $(a, 0)$  plus a line sink of strength  $-m$  at  $(-a, 0)$ . What is the pattern viewed from afar?



**Fig. P8.19**

**Solution:** The pattern viewed close-up is shown at upper right—there is a stagnation point to the left of the sink, at  $(x, y) = (-2a, 0)$ . The pattern viewed from afar is at right and represents a single source of strength  $+2m$ . *Ans.*



**8.20** Plot the streamlines of the flow due to a line vortex of strength  $+K$  at  $(0, +a)$  plus a line vortex of strength  $-K$  at  $(0, -a)$ . What is the pattern viewed from afar?

**Solution:** The pattern viewed close-up is shown at right (see Fig. 8.17*b* of the text). The pattern viewed from afar represents **little or nothing**, since the two vortices cancel strengths and cause no flow at  $\infty$ . *Ans.*

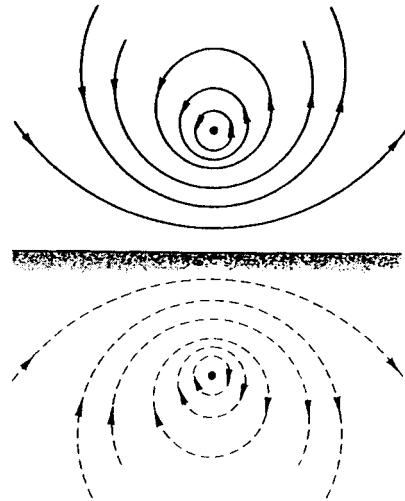


Fig. P8.20

**8.21** Plot the streamlines of the flow due to a line vortex  $+K$  at  $(+a, 0)$  and a vortex  $(-2K)$  at  $(-a, 0)$ . What is the pattern viewed from afar?

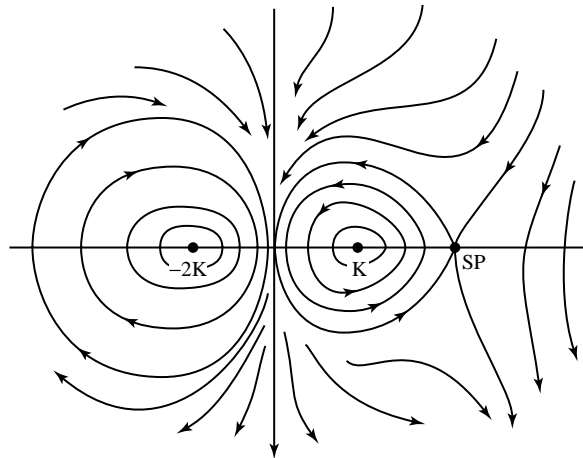


Fig. P8.21

**Solution:** From close-up, the flow looks like the “cat’s eyes” at right. There is a stagnation point at  $(x, y) = (2a, 0)$ . From afar (not shown), the pattern looks like a *clockwise* vortex of strength  $-K$ .

**8.22** Plot the streamlines of a uniform stream  $\mathbf{V} = \mathbf{i}U$  plus a clockwise line vortex  $-K$  at the origin. Are there any stagnation points?

**Solution:** This pattern is the same as Fig. 8.6 in the text, except it is upside down. There is a stagnation point at  $(x, y) = (0, -K/U)$ . *Ans.*

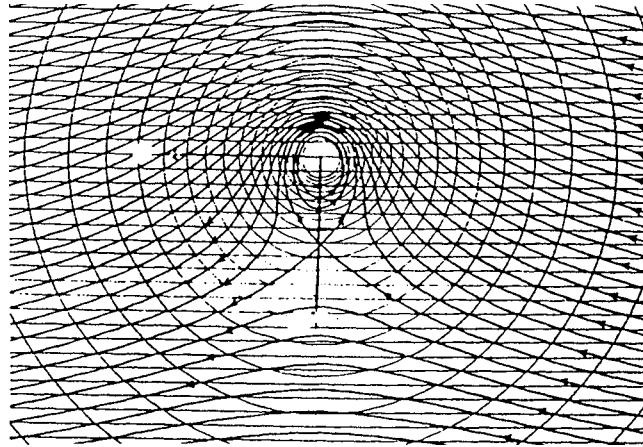


Fig. P8.22

**8.23** Find the resultant velocity vector induced at point A in Fig. P8.23 due to the combination of uniform stream, vortex, and line source.

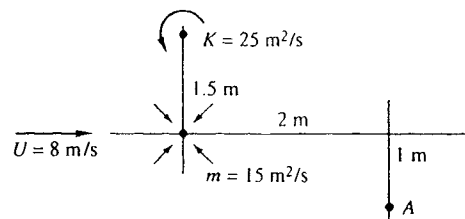
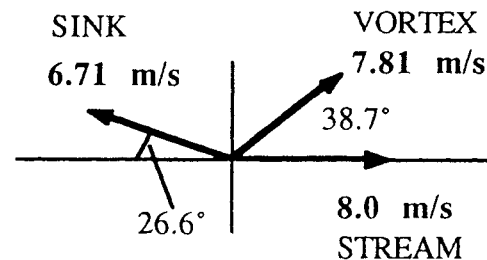


Fig. P8.23

**Solution:** The velocities caused by each term—stream, vortex, and sink—are shown at right. They have to be added together vectorially to give the final result:

$$\mathbf{V} = 11.3 \frac{\text{m}}{\text{s}} \text{ at } \theta = 44.2^\circ \angle \text{ Ans.}$$



**8.24** Line sources of equal strength  $m = Ua$ , where  $U$  is a reference velocity, are placed at  $(x, y) = (0, a)$  and  $(0, -a)$ . Sketch the stream and potential lines in the upper half plane. Is  $y = 0$  a “wall”? If so, sketch the pressure coefficient

$$C_p = \frac{P - P_0}{\frac{1}{2} \rho U^2}$$

along the wall, where  $p_0$  is the pressure at  $(0, 0)$ . Find the minimum pressure point and indicate

where flow separation might occur in the boundary layer.

**Solution:** This problem is an “image” flow and is sketched in Fig. 8.17a of the text. Clearly  $y = 0$  is a “wall” where

$$u = 2u_s = \frac{2Ua}{\sqrt{x^2 + a^2}} \cdot \frac{x}{\sqrt{x^2 + a^2}} = 2Ua/(x^2 + a^2)$$

From Bernoulli,  $p + \rho u^2/2 = p_o$ ,

$$C_p = \frac{p - p_o}{(1/2)\rho U^2} = -\frac{u^2}{U^2} = -\left[ \frac{2x/a}{1 + (x/a)^2} \right]^2 \quad \text{Ans.}$$

The minimum pressure coefficient is  $C_{p,\min} = -1.0$  at  $x = a$ , as shown in the figure. Beyond this point, pressure increases (*adverse gradient*) and separation is possible.

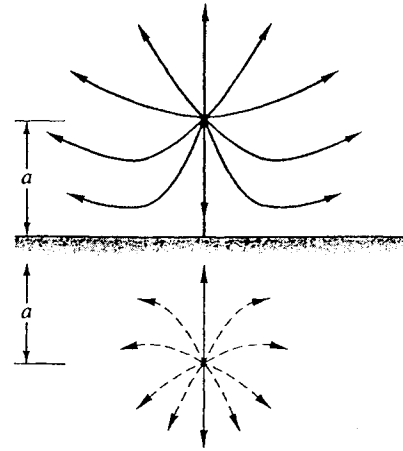
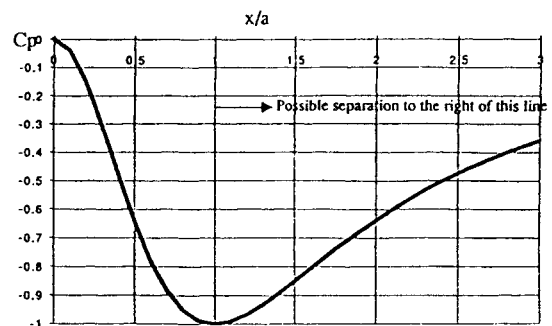


Fig. P8.24



**8.25** Let the vortex/sink flow of Eq. (4.134) simulate a tornado as in Fig. P8.25. Suppose that the circulation about the tornado is  $\Gamma = 8500 \text{ m}^2/\text{s}$  and that the pressure at  $r = 40 \text{ m}$  is 2200 Pa less than the far-field pressure. Assuming inviscid flow at sea-level density, estimate (a) the appropriate sink strength  $-m$ , (b) the pressure at  $r = 15 \text{ m}$ , and (c) the angle  $\beta$  at which the streamlines cross the circle at  $r = 40 \text{ m}$  (see Fig. P8.25).

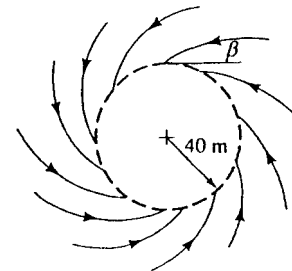


Fig. P8.25

**Solution:** The given circulation yields the circumferential velocity at  $r = 40 \text{ m}$ :

$$v_\theta = \frac{\Gamma}{2\pi r} = \frac{8500}{2\pi(40)} \approx 33.8 \frac{\text{m}}{\text{s}}$$

Assuming sea-level density  $\rho = 1.225 \text{ kg/m}^3$ , we use Bernoulli to find the radial velocity:

$$p_\infty + \frac{\rho}{2}(0)^2 = (p_\infty - \Delta p) + \frac{\rho}{2}(v_\theta^2 + v_r^2) = p_\infty - 2200 + \frac{1.225}{2}[(33.8)^2 + v_r^2]$$

$$\text{Solve for } v_r \approx 49.5 \frac{\text{m}}{\text{s}} = \frac{m}{r} = \frac{m}{40}, \quad \therefore m \approx \mathbf{1980 \frac{\text{m}^2}{\text{s}}} \quad \text{Ans. (a)}$$

With circumferential and radial (inward) velocity known, the streamline angle  $\beta$  is

$$\beta = \tan^{-1}\left(\frac{v_r}{v_\theta}\right) = \tan^{-1}\left(\frac{49.5}{33.8}\right) \approx \mathbf{55.6^\circ} \quad \text{Ans. (c)}$$

(b) At  $r = 15 \text{ m}$ , compute  $v_r = m/r = 1980/15 \approx 132 \text{ m/s}$  (unrealistically high) and  $v_\theta = \Gamma/2\pi r = 8500/[2\pi(15)] \approx 90 \text{ m/s}$  (high again, there is probably a viscous core here). Then we use Bernoulli again to compute the pressure at  $r = 15 \text{ m}$ :

$$p + \frac{1.225}{2}[(132)^2 + (90)^2] = p_\infty, \quad \text{or } p \approx p_\infty - \mathbf{15700 \text{ Pa}} \quad \text{Ans. (b)}$$

If we assume sea-level pressure of  $101 \text{ kPa}$  at  $\infty$ , then  $p_{\text{absolute}} = 101 - 16 \approx \mathbf{85 \text{ kPa}}$ .

**8.26** Find the resultant velocity induced at point A in Fig. P8.26 by the uniform stream, line source, line sink, and line vortex.

**Solution:** The source and sink are each  $\sqrt{5} = 2.24 \text{ m}$  from point A, so the sink velocity is  $10/2.24 = 4.47 \text{ m/s}$  and the source velocity is  $12/2.24 = 5.37 \text{ m/s}$ , as shown. The vortex velocity is  $9/2 = 4.5 \text{ m/s}$ .

The net horizontal component is  $6.44 \text{ m/s}$ . The net vertical component is  $-6.85 \text{ m/s}$  (down). Then the resultant induced velocity at A is

$$V = \sqrt{(6.85)^2 + (6.44)^2} \approx \mathbf{9.40 \frac{\text{m}}{\text{s}}}$$

$$\text{at } \theta = \tan^{-1}\left(\frac{-6.85}{6.44}\right) \approx \mathbf{-46.8^\circ} \quad \text{Ans.}$$

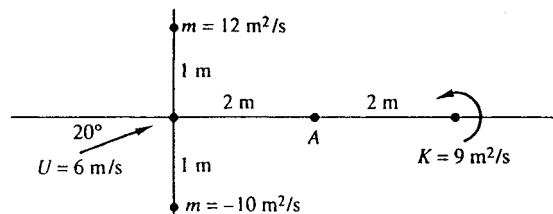
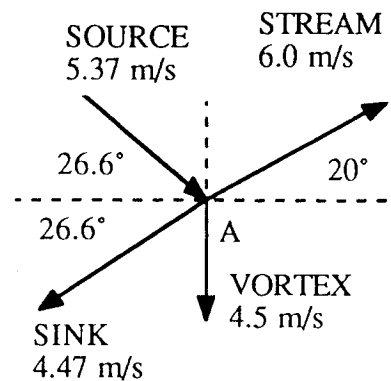


Fig. P8.26



**8.27** Water at 20°C flows past a half-body as shown in Fig. P8.27. Measured pressures at points A and B are 160 kPa and 90 kPa, respectively, with uncertainties of 3 kPa each. Estimate the stream velocity and its uncertainty.

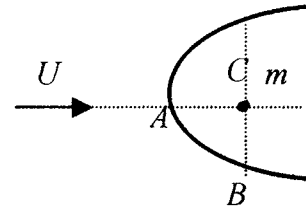


Fig. P8.27

**Solution:** Since Eq. (8.18) is for the upper surface, use it by noting that  $V_C = V_B$  in the figure:

$$\frac{r_C}{a} = \frac{\pi - \pi/2}{\sin(\pi/2)} = \frac{\pi}{2}, \quad V_C^2 = V_B^2 = U_\infty^2 \left[ 1 + \left( \frac{2}{\pi} \right)^2 + \frac{2}{(\pi/2)} \cos(\pi/2) \right] = 1.405U_\infty^2$$

$$\text{Bernoulli: } p_A + \frac{\rho}{2} V_A^2 = 160000 + 0 = p_B + \frac{\rho}{2} V_B^2 = 90000 + \frac{998}{2} (1.405U_\infty^2)$$

$$\text{Solve for } U_\infty \approx \mathbf{10.0 \text{ m/s}} \quad \text{Ans.}$$

The uncertainty in  $(p_A - p_B)$  is as high as 6000 Pa, hence the uncertainty in  $U_\infty$  is  $\pm 0.4 \text{ m/s}$ . *Ans.*

**8.28** Sources of equal strength  $m$  are placed at the four symmetric positions  $(a, a)$ ,  $(-a, a)$ ,  $(a, -a)$ , and  $(-a, -a)$ . Sketch the streamline and potential-line patterns. Do any plane “walls” appear?

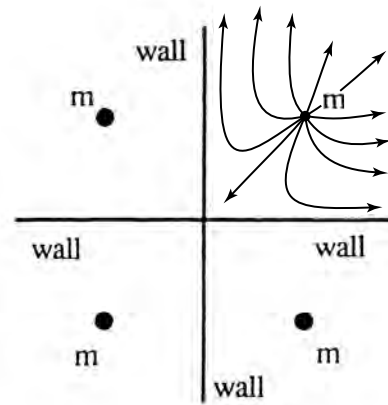


Fig. P8.28

**8.29** A uniform water stream,  $U_\infty = 20 \text{ m/s}$  and  $\rho = 998 \text{ kg/m}^3$ , combines with a source at the origin to form a half-body. At  $(x, y) = (0, 1.2 \text{ m})$ , the pressure is 12.5 kPa less than  $p_\infty$ .

- (a) Is this point outside the body? Estimate  
 (b) the appropriate source strength  $m$  and  
 (c) the pressure at the nose of the body.

**Solution:** We know, from Fig. 8.5 and Eq. 8.18, the point on the half-body surface just above “ $m$ ” is at  $y = \pi a/2$ , as shown, where  $a = m/U$ . The Bernoulli equation allows us to compute the necessary source strength  $m$  from the pressure at  $(x, y) = (0, 1.2 \text{ m})$ :

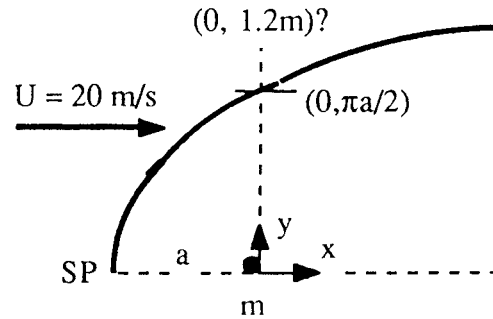


Fig. P8.29

$$p_{\infty} + \frac{\rho}{2} U_{\infty}^2 = p_{\infty} + \frac{998}{2} (20)^2 = p_{\infty} - 12500 + \frac{998}{2} \left[ (20)^2 + \left( \frac{m}{1.2} \right)^2 \right]$$

$$\text{Solve for } m \approx 6.0 \frac{\text{m}^2}{\text{s}} \quad \text{Ans. (b)} \quad \text{while } a = \frac{m}{U} = \frac{6.0}{20} = 0.3 \text{ m}$$

The body surface is thus at  $y = \pi a/2 = 0.47 \text{ m}$  above  $m$ . Thus the point in question,  $y = 1.2 \text{ m}$  above  $m$ , is **outside the body**. Ans. (a)

At the nose SP of the body,  $(x, y) = (-a, 0)$ , the velocity is zero, hence we predict

$$p_{\infty} + \frac{\rho}{2} U_{\infty}^2 = p_{\infty} + \frac{998}{2} (20)^2 = p_{\text{nose}} + \frac{\rho}{2} (0)^2, \quad \text{or } p_{\text{nose}} \approx p_{\infty} + 200 \text{ kPa} \quad \text{Ans. (c)}$$

**8.30** Suppose that the total discharge from the manifold in Fig. P8.11 is  $450 \text{ m}^3/\text{s}$  and that there is a uniform ocean current of  $60 \text{ cm/s}$  to the right. Sketch the flow pattern from above, showing the dimensions and the region where the cooling-water discharge is confined.

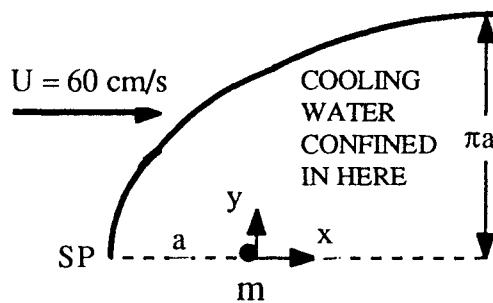


Fig. P8.30

**Solution:** From Prob. 8.11, with  $Q$  known and  $b = 8 \text{ m}$ , we compute the source strength:

$$m = \frac{Q}{2\pi b} = \frac{450 \text{ m}^3/\text{s}}{2\pi(8 \text{ m})} = 8.95 \frac{\text{m}^2}{\text{s}}, \quad \text{hence } a = \frac{m}{U} = \frac{8.95}{0.6} \approx 15 \text{ m} \quad \text{Ans. (a)}$$

$$\text{The half-width of the confined region} = \pi a = \pi(15) \approx 47 \text{ m} \quad \text{Ans. (b)}$$

The discharge water is confined to a region 94 m wide and 15 m in front of the manifold.



**8.31** A Rankine half-body is formed as shown in Fig. P8.31. For the conditions shown, compute (a) the source strength  $m$  in  $\text{m}^2/\text{s}$ ; (b) the distance  $a$ ; (c) the distance  $h$ ; and (d) the total velocity at point A.

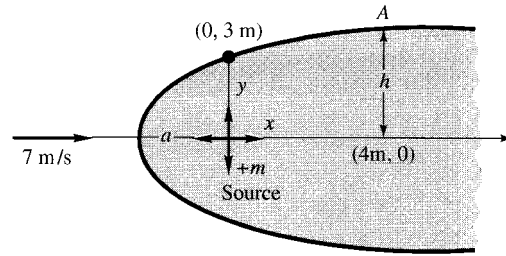


Fig. P8.31

**Solution:** The vertical distance above the origin is a known multiple of  $m$  and  $a$ :

$$y_{x=0} = 3 \text{ m} = \frac{\pi m}{2U} = \frac{\pi m}{2(7)} = \frac{\pi a}{2},$$

$$\text{or } m \approx 13.4 \frac{\text{m}^2}{\text{s}} \quad \text{and} \quad a \approx 1.91 \text{ m} \quad \text{Ans. (a, b)}$$

The distance  $h$  is found from the equation for the body streamline:

$$\text{At } x = 4 \text{ m, } r_{\text{body}} = \frac{m(\pi - \theta)}{U \sin \theta} = \frac{13.4(\pi - \theta)}{7 \sin \theta} = \frac{4.0}{\cos \theta}, \quad \text{solve for } \theta \approx 47.8^\circ$$

$$\text{Then } r_A = 4.0 / \cos(47.8^\circ) = 5.95 \text{ m} \quad \text{and} \quad h = r \sin \theta \approx 4.41 \text{ m} \quad \text{Ans. (c)}$$

The resultant velocity at point A is then computed from Eq. (8.18):

$$V_A = U \left( 1 + \frac{a^2}{r^2} + \frac{2a}{r} \cos \theta_A \right)^{1/2} = 7 \left[ 1 + \left( \frac{1.91}{5.95} \right)^2 + 2 \left( \frac{1.91}{5.95} \right) \cos 47.8^\circ \right]^{1/2} \approx 8.7 \frac{\text{m}}{\text{s}} \quad \text{Ans. (d)}$$

**8.32** Sketch the streamlines, especially the body shape, due to equal line sources  $m$  at  $(-a, 0)$  and  $(+a, 0)$  plus a uniform stream  $U_\infty = ma$ .

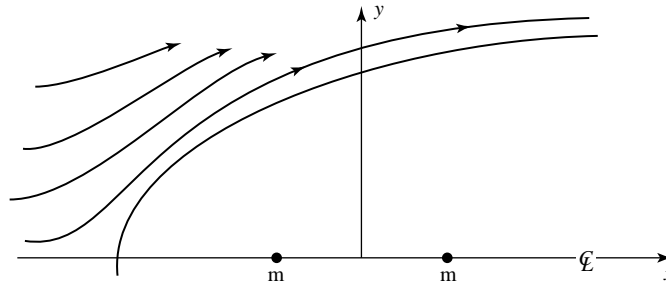
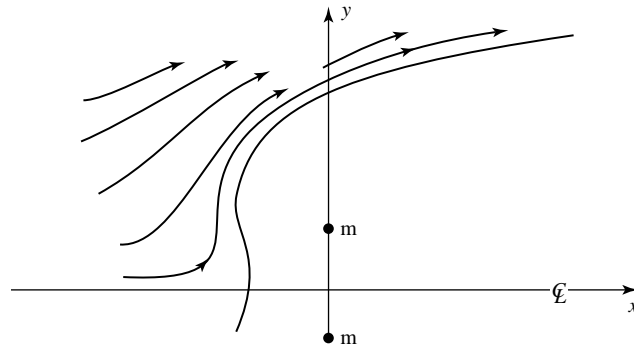


Fig. P8.32

**Solution:** As shown, a half-body shape is formed quite similar to the Rankine half-body. The stagnation point, for this special case  $U_\infty = ma$ , is at  $x = (-1 - \sqrt{2})a = -2.41a$ . The half-body shape would vary with the dimensionless source-strength parameter  $(U_\infty a/m)$ .

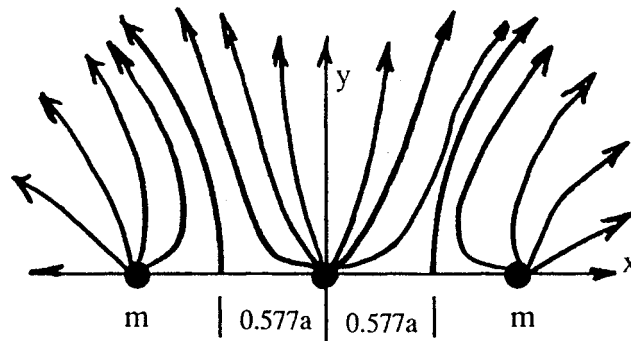
**8.33** Sketch the streamlines, especially the body shape, due to equal line sources  $m$  at  $(0, +a)$  and  $(0, -a)$  plus a uniform stream  $U_\infty = ma$ .



**Fig. P8.33**

**Solution:** As shown, a half-body shape is formed which has a dimple at the nose. The stagnation point, for this special case  $U_\infty = ma$ , is at  $x = -a$ . The half-body shape varies with the parameter  $(U_\infty a/m)$ .

**8.34** Consider three equally spaced line sources  $m$  placed at  $(x, y) = (+a, 0)$ ,  $(0, 0)$ , and  $(-a, 0)$ . Sketch the resulting streamlines and note any stagnation points. What would the pattern look like from afar?



**Fig. P8.34**

**Solution:** The pattern (symmetrical about the  $x$ -axis) is shown above. There are two stagnation points, at  $x = \pm a/\sqrt{3} = \pm 0.577a$ . Viewed from afar, the pattern would look like a single source of strength  $3m$ .

**8.35** Consider three equal sources in a triangular configuration: one at  $(a/2, 0)$ , one at  $(-a/2, 0)$ , and one at  $(0, a)$ . Plot the streamlines for this flow. Are there any stagnation points? *Hint:* Try the MATLAB Contour command [Ref. 34].

**Solution:** We have  $\psi = m \tan^{-1}(y/(x - 0.5a)) + m \tan^{-1}(y/(x + 0.5a)) + m \tan^{-1}((y - a)/x)$ . The streamlines are shown in the figure below. There is *one* stagnation point: on the y-axis at  $(0, 0.5a)$ . Viewed from afar, it looks like a **single source of strength  $(3m)$** .

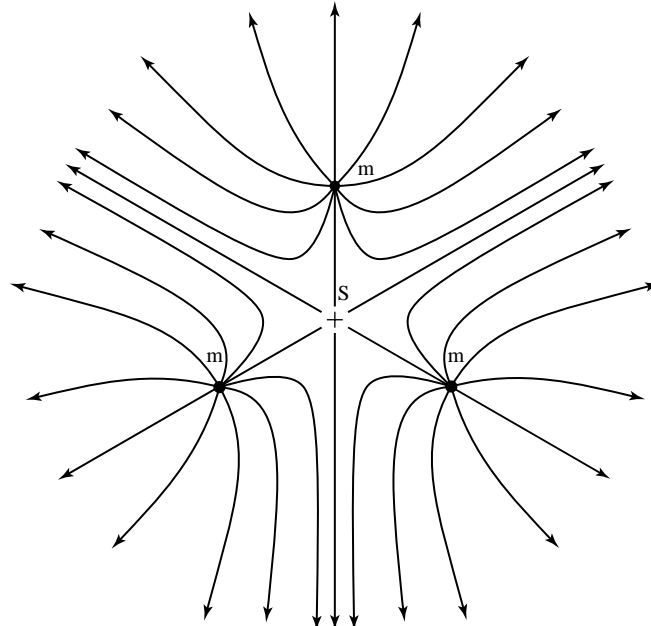


Fig. P8.35

**8.36** When a line source-sink pair with  $m = 2 \text{ m}^2/\text{s}$  is combined with a uniform stream, it forms a Rankine oval whose minimum dimension is 40 cm, as shown. If  $a = 15 \text{ cm}$ , what are the stream velocity and the maximum velocity? What is the length?

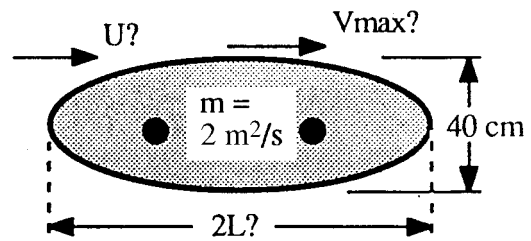


Fig. P8.36

**Solution:** We know  $h/a = 20/15$ , so from Eq. (8.30) we may determine the stream velocity:

$$\frac{h}{a} = \frac{20}{15} = \cot \left[ \frac{h/a}{2m/(U_\infty a)} \right] = \cot \left[ \frac{20/15}{2(2)/(0.15U_\infty)} \right], \quad \text{solve for } U_\infty \approx 12.9 \frac{\text{m}}{\text{s}} \quad \text{Ans.}$$

$$\text{Then } \frac{m}{U_\infty a} = \frac{2}{12.9(0.15)} = 1.036, \quad \frac{L}{a} = [1 + 2(1.036)]^{1/2} = 1.75, \quad 2L \approx 53 \text{ cm} \quad \text{Ans.}$$

$$\text{Finally, } \frac{V_{\max}}{U_\infty} = 1 + \frac{2m/(U_\infty a)}{1 + (h/a)^2} = 1 + \frac{2(1.036)}{1 + (20/15)^2} = 1.75, \quad V_{\max} \approx 22.5 \frac{\text{m}}{\text{s}} \quad \text{Ans.}$$

**8.37** A Rankine oval 2 m long and 1 m high is immersed in a stream  $U_\infty = 10$  m/s, as in Fig. P8.37. Estimate (a) the velocity at point A and (b) the location of point B where a particle approaching the stagnation point achieves its maximum deceleration.

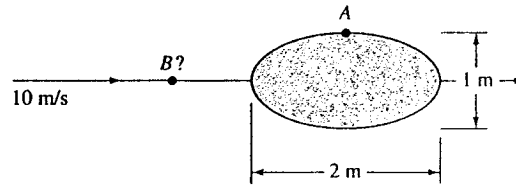


Fig. P8.37

**Solution:** (a) With  $L/h = 2.0$ , we may evaluate Eq. (8.30) to find the source-sink strength:

$$\frac{h}{a} = \cot \left[ \frac{h/a}{2m/(U_\infty a)} \right] \quad \text{and} \quad \frac{L}{a} = \left( 1 + \frac{2m}{U_\infty a} \right)^{1/2}$$

$$\text{converges to} \quad \frac{L}{h} = 2.0 \quad \text{if} \quad \frac{m}{U_\infty a} = \mathbf{0.3178}$$

$$\text{Meanwhile,} \quad \frac{h}{a} = 0.6395 \quad \text{and} \quad \frac{L}{a} = 1.2789 \quad \text{thus} \quad a = \frac{1 \text{ meter}}{1.2789} \approx \mathbf{0.782 \text{ m}}$$

Also compute  $V_{\max}/U_\infty = 1.451$ , hence  $V_{\max} = 1.451(10) \approx \mathbf{14.5 \text{ m/s}}$ . *Ans.* (a)

(b) Along the  $x$ -axis, at any  $x \leq -L$ , the velocity toward the body nose has the form

$$u = U_\infty + \frac{m}{a+x} + \frac{m}{a-x}, \quad \text{where} \quad m \approx 0.3178 U_\infty a$$

$$\text{Then} \quad \frac{du}{dt} = u \frac{\partial u}{\partial x} = \left[ U_\infty + \frac{m}{a+x} + \frac{m}{a-x} \right] (-m) \left[ \frac{1}{(a+x)^2} - \frac{1}{(a-x)^2} \right]$$

For this value of  $m$ , the maximum deceleration occurs at  $\mathbf{x = -1.41a}$  *Ans.*

This is quite near the nose (which is at  $x = -1.28a$ ). The numerical value of the maximum deceleration is  $(du/dt)_{\max} \approx \mathbf{-0.655 U_\infty^2/a}$ .

**8.38** A uniform stream  $U$  in the  $x$  direction combines with a source  $m$  at  $(+a, 0)$  and a sink  $-m$  at  $(-a, 0)$ . Plot the resulting streamlines and note any stagnation points.

**Solution:** There are two cases. (a) For  $m > U_\infty a/2$ , there are two stagnation points on the **y-axis**; (b) for  $m < U_\infty a/2$ , there are two stagnation points on the **x-axis**:

$$\text{(a) } m > \frac{U_\infty a}{2}: \quad \mathbf{y_{stag} = \pm \sqrt{\frac{2m}{U_\infty a} - 1}}; \quad \text{(b) } m < \frac{U_\infty a}{2}: \quad \mathbf{x_{stag} = \pm \sqrt{1 - \frac{2m}{U_\infty a}}} \quad \text{Ans.}$$

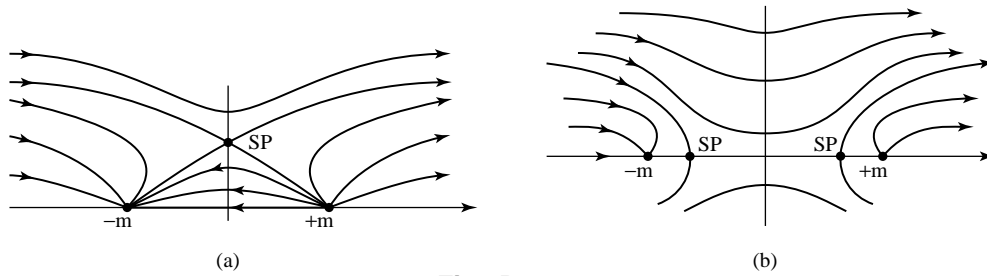


Fig. P8.38

**8.39** Find the value of  $m/(U_\infty a)$  for which the velocity in the inside center of a Rankine oval exactly equals  $3U_\infty$ .

**Solution:** From the geometry of Fig. 8.9, the velocity in the center of the oval is:

$$V_{Origin} = U_\infty + \frac{m}{a} \Big|_{source} + \frac{m}{a} \Big|_{sink} = 3U_\infty \quad \text{if} \quad \frac{m}{U_\infty a} = 1.0 \quad \text{Ans.}$$

**8.40** Consider a uniform stream  $U_\infty$  plus line sources (+m) at (+a, 0) and (-a, 0) and a single line sink (-2m) at (0, 0). Does a closed body shape appear? If so, plot its shape for  $m/(U_\infty a)$  equal to (a) 1.0; and (b) 5.0.

**Solution:** Although the flow of the sources balances the sink, there is **no decent body shape**. The sink is too strong. The two cases requested are shown below.

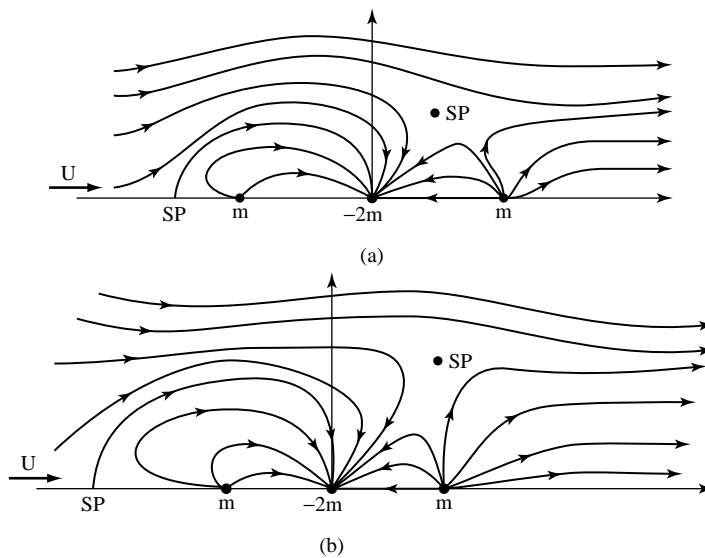


Fig. P8.40

**8.41** A Kelvin oval is formed by a line-vortex pair with  $K = 9 \text{ m}^2/\text{s}$ ,  $a = 1 \text{ m}$ , and  $U = 10 \text{ m/s}$ . What are the height, width, and shoulder velocity of this oval?

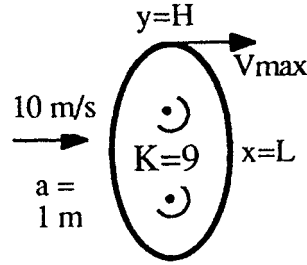


Fig. P8.41

**Solution:** With reference to Fig. 8.12 and Eq. (8.41), the oval is described by

$$\psi = 0, \quad x = 0, \quad y = H: \quad UH = \frac{K}{2} \ln \left[ \frac{(H+a)^2}{(H-a)^2} \right], \quad \text{with} \quad \frac{K}{Ua} = \frac{9}{10(1)} = 0.9$$

Solve by iteration for  $H/a \approx 1.48$ , or  $2H = \text{oval height} \approx 2.96 \text{ m}$  Ans.

Similarly,  $\frac{L}{a} = \left( \frac{2K}{Ua} - 1 \right)^{1/2} = [2(0.9) - 1]^{1/2} = 0.894$ ,  $2L = \text{width} \approx 1.79 \text{ m}$  Ans.

Finally,  $V_{\max} = U + \frac{K}{H-a} - \frac{K}{H+a} = 10 + \frac{9}{0.48} - \frac{9}{2.48} \approx 25.1 \frac{\text{m}}{\text{s}}$  Ans.

**8.42** For what value of  $K/(U_\infty a)$  does the velocity at the shoulder of a Kelvin oval equal  $4U_\infty$ ? What is height  $h/a$  of this oval?

**Solution:** Following up on the formulas from Prob. 8.41, we are to iterate between the oval-height and maximum-velocity formulas from Eq. (8.41):

$$V_{\max} = U_\infty + \frac{K}{h-a} - \frac{K}{h+a} = 4U_\infty \quad \text{plus} \quad \frac{h}{a} = \frac{K}{U_\infty a} \ln \left[ \frac{h/a + 1}{h/a - 1} \right], \quad \text{solve for } h \text{ and } K.$$

After effort (PC calculation is best), we find  $K/(U_\infty a) \approx 0.396$ ,  $h/a \approx 1.124$ . Ans.

**8.43** Consider water at  $20^\circ\text{C}$  flowing past a 1-m-diameter cylinder. What doublet strength in  $\text{m}^2/\text{s}$  is required to simulate this flow? If the stream pressure is 200 kPa, use inviscid theory to estimate the surface pressure at (a)  $180^\circ$ ; (b)  $135^\circ$ ; and (c)  $90^\circ$ .

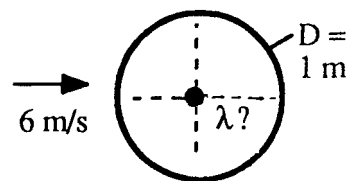


Fig. P8.43

**Solution:** For water at  $20^\circ\text{C}$ , take  $\rho = 998 \text{ kg/m}^3$ . The required doublet strength is

$$\lambda = U_\infty a^2 = (6.0 \text{ m/s})(0.5 \text{ m})^2 \approx 1.5 \frac{\text{m}^3}{\text{s}} \quad \text{Ans.}$$

The surface pressures are computed from Bernoulli's equation, with  $V_{\text{surface}} = 2U_{\infty}\sin\theta$ :

$$p_s + \frac{\rho}{2}(2U_{\infty}\sin\theta)^2 = p_{\infty} + \frac{\rho}{2}U_{\infty}^2, \quad \text{or:} \quad p_s = 200000 + \frac{998}{2}(6)^2(1 - 4\sin^2\theta)$$

(a) at  $180^\circ$ ,  $p_s \approx \mathbf{218000 \text{ Pa}}$ ; (b) at  $135^\circ$ ,  $\mathbf{182000 \text{ Pa}}$ ; (c) at  $90^\circ$ ,  $\mathbf{146000 \text{ Pa}}$  Ans. (a, b, c)

---

**8.44** Suppose that circulation is added to the cylinder flow of Prob. 8.43 sufficient to place the stagnation points at  $\theta = 35^\circ$  and  $145^\circ$ . What is the required vortex strength  $K$  in  $\text{m}^2/\text{s}$ ? Compute the resulting pressure and surface velocity at (a) the stagnation points, and (b) the upper and lower shoulders. What will be the lift per meter of cylinder width?

**Solution:** Recall that Prob. 8.43 was for water at  $20^\circ\text{C}$  flowing at  $6 \text{ m/s}$  past a  $1\text{-m}$ -diameter cylinder, with  $p_{\infty} = 200 \text{ kPa}$ . From Eq. (8.35),

$$\sin\theta_{\text{stag}} = \sin(35^\circ) = \frac{K}{2U_{\infty}a} = \frac{K}{2(6 \text{ m/s})(0.5 \text{ m})}, \quad \text{or:} \quad \mathbf{K = 3.44 \text{ m}^2/\text{s}} \quad \text{Ans.}$$

(a) At the stagnation points, velocity is zero and pressure equals stagnation pressure:

$$p_{\text{stag}} = p_{\infty} + \frac{\rho}{2}U_{\infty}^2 = 200,000 \text{ Pa} + \frac{998 \text{ kg/m}^3}{2}(6 \text{ m/s})^2 = \mathbf{218,000 \text{ Pa}} \quad \text{Ans. (a)}$$

(b) At any point on the surface, from Eq. (8.37),

$$p_{\text{stag}} = 218000 = p_{\text{surf}} + \frac{\rho}{2}\left(-2U_{\infty}\sin\theta + \frac{K}{a}\right)^2 = p_{\text{surf}} + \frac{998}{2}\left[-2(6)\sin\theta + \frac{3.44}{0.5}\right]^2$$

*At the upper shoulder,  $\theta = 90^\circ$ ,*

$$p = 218000 - \frac{998}{2}(-5.12)^2 \approx \mathbf{204,900 \text{ Pa}} \quad \text{Ans. (b—upper)}$$

*At the lower shoulder,  $\theta = 270^\circ$ ,*

$$p = 218000 - \frac{998}{2}(-18.88)^2 \approx \mathbf{40,100 \text{ Pa}} \quad \text{Ans. (b—lower)}$$


---

**8.45** If circulation  $K$  is added to the cylinder flow in Prob. 8.43, (a) for what value of  $K$  will the flow begin to cavitate at the surface? (b) Where on the surface will cavitation begin? (c) For this condition, where will the stagnation points lie?

**Solution:** Recall that Prob. 8.43 was for water at 20°C flowing at 6 m/s past a 1-m-diameter cylinder, with  $p_\infty = 200$  kPa. From Table A.5,  $p_{\text{vap}} = 2337$  Pa. (b) Cavitation will occur at the lowest pressure point, which is **at the bottom shoulder ( $\theta = 270^\circ$ )** in Fig. 8.10. *Ans.* (b)

(a) Use Bernoulli's equation to estimate the velocity at  $\theta = 270^\circ$  if the pressure there is  $p_{\text{vap}}$ :

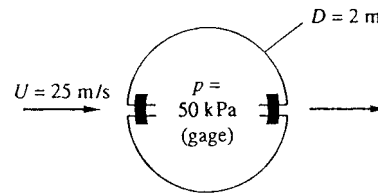
$$p_o = 218000 \text{ Pa} = p_{\text{vap}} + \frac{\rho}{2} V_{\text{surf}}^2 = 2337 \text{ Pa} + \frac{998 \text{ kg/m}^3}{2} \left[ (-2)(6 \text{ m/s}) \sin(270^\circ) + \frac{K}{0.5 \text{ m}} \right]^2$$

$$\text{Solve for: } \mathbf{K_{\text{cavitation}} \approx 4.39 \text{ m}^2/\text{s}} \quad \text{Ans. (a)}$$

(c) The locations of the two stagnation points are given by Eq. (8.35):

$$\sin \theta_{\text{stag}} = \frac{K}{2U_\infty a} = \frac{4.39 \text{ m}^2/\text{s}}{2(6 \text{ m/s})(0.5 \text{ m})} = 0.732, \quad \theta_{\text{stag}} = \mathbf{47^\circ \text{ and } 133^\circ} \quad \text{Ans. (c)}$$

**8.46** A cylinder is formed by bolting two semicylindrical channels together on the inside, as shown in Fig. P8.46. There are 10 bolts per meter of width on each side, and the inside pressure is 50 kPa (gage). Using potential theory for the outside pressure, compute the tension force in each bolt if the fluid outside is sea-level air.



**Fig. P8.46**

**Solution:** For sea-level air take  $\rho = 1.225 \text{ kg/m}^3$ . Use Bernoulli to find surface pressure:

$$p_\infty + \frac{\rho}{2} U_\infty^2 = 0 + \frac{1.225}{2} (25)^2 = p_s + \frac{1.225}{2} (2U_\infty \sin \theta)^2, \quad \text{or: } p_s = 383 - 1531 \sin^2 \theta$$

$$\text{compute } F_{\text{down}} = 2 \int_0^{\pi/2} p \sin \theta \text{ b a } d\theta = 2 \int_0^{\pi/2} (383 - 1531 \sin^2 \theta) \sin \theta (1 \text{ m})(1 \text{ m}) d\theta = -1276 \frac{\text{N}}{\text{m}}$$

This is small potatoes compared to the force due to *inside* pressure:

$$F_{\text{up}} = 2p_{\text{inside}} ab = 2(50000)(1)(1) = 100000 \frac{\text{N}}{\text{m}}$$

$$\text{Total force per meter} = 100000 - (-1276) = 101276 \div 20 \text{ bolts} \approx \mathbf{5060 \frac{\text{N}}{\text{bolt}}} \quad \text{Ans.}$$



**8.47** A circular cylinder is fitted with two pressure sensors, to measure pressure at “a” ( $180^\circ$ ) and “b” ( $105^\circ$ ), as shown. The intent is to use this cylinder as a stream velocity velocimeter. Using inviscid theory, derive a formula for calculating  $U_\infty$  from  $p_a$ ,  $p_b$ ,  $\rho$ , and radius  $a$ .

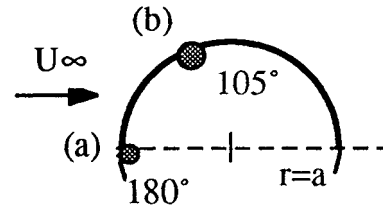


Fig. P8.47

**Solution:** We relate the pressures to surface velocities from Bernoulli's equation:

$$p_\infty + \frac{\rho}{2} U_\infty^2 = p_a + \frac{\rho}{2} (0)^2 = p_b + \frac{\rho}{2} (2U_\infty \sin 105^\circ)^2, \quad \text{or:} \quad U_\infty = \frac{1}{\sin 105^\circ} \sqrt{\frac{p_a - p_b}{2\rho}} \quad \text{Ans.}$$

This is not a bad idea for a velocimeter, except that (1) it should be calibrated; and (2) it must be carefully aligned so that sensor “a” exactly faces the oncoming stream.

**8.48** Wind at  $U_\infty$  and  $p_\infty$  flows past a Quonset hut which is a half-cylinder of radius  $a$  and length  $L$  (Fig. P8.48). The internal pressure is  $p_i$ . Using inviscid theory, derive an expression for the upward force on the hut due to the difference between  $p_i$  and  $p_s$ .

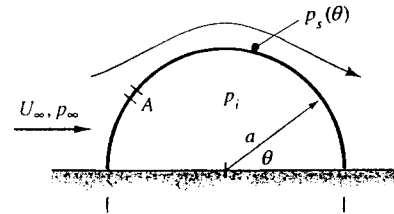


Fig. P8.48

**Solution:** The analysis is similar to Prob. 8.46 on the previous page. If  $p_o$  is the stagnation pressure at the nose ( $\theta = 180^\circ$ ), the surface pressure distribution is

$$p_s = p_o - \frac{\rho}{2} U_s^2 = p_o - \frac{\rho}{2} (2U_\infty \sin \theta)^2 = p_o - 2\rho U_\infty^2 \sin^2 \theta$$

Then the net upward force on the half-cylinder is found by integration:

$$F_{\text{up}} = \int_0^\pi (p_i - p_s) \sin \theta ab d\theta = \int_0^\pi (p_i - p_o + 2\rho U_\infty^2 \sin^2 \theta) \sin \theta ab d\theta,$$

$$\text{or:} \quad \mathbf{F_{up}} = (\mathbf{p_i} - \mathbf{p_o})\mathbf{2ab} + \frac{\mathbf{8}}{\mathbf{3}}\rho\mathbf{U_\infty^2} \mathbf{ab} \quad \text{Ans.} \quad \left( \text{where } p_o = p_\infty + \frac{\rho}{2} U_\infty^2 \right)$$

**8.49** In strong winds, the force in Prob. 8.48 above can be quite large. Suppose that a hole is introduced in the hut roof at point A (see Fig. P8.48) to make  $p_i$  equal to the surface pressure  $p_A$ . At what angle  $\theta$  should hole A be placed to make the net force zero?

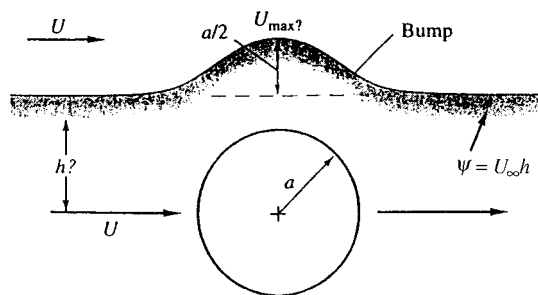
**Solution:** Set  $F = 0$  in Prob. 8.48 and find the proper pressure from Bernoulli:

$$F_{\text{up}} = 0 \text{ if } p_i = p_o - \frac{4}{3}\rho U_\infty^2, \text{ but also } p_i = p_A = p_o - \frac{\rho}{2}(2U_\infty \sin\theta_A)^2$$

$$\text{Solve for } \sin\theta_A = \sqrt{2/3} = 0.817 \text{ or } \theta_A \approx 125^\circ \text{ Ans.}$$

(or  $55^\circ$  = poor position on rear of body)

**8.50** It is desired to simulate flow past a ridge or “bump” by using a streamline *above* the flow over a cylinder, as shown in Fig. P8.50. The bump is to be  $a/2$  high, as shown. What is the proper elevation  $h$  of this streamline? What is  $U_{\text{max}}$  on the bump compared to  $U_\infty$ ?



**Fig. P8.50**

**Solution:** Apply the equation of the streamline (Eq. 8.32) to  $\theta = 180^\circ$  and also  $90^\circ$ :

$$\psi = U_\infty \sin\theta \left( r - \frac{a^2}{r} \right) \text{ at } \theta = 180^\circ \text{ (the freestream) gives } \psi = U_\infty h$$

$$\text{Then, at } \theta = 90^\circ, \quad r = h + \frac{a}{2}, \quad \psi = U_\infty h = U_\infty \sin 90^\circ \left( h + \frac{a}{2} - \frac{a^2}{h + a/2} \right)$$

$$\text{Solve for } \mathbf{h = \frac{3}{2}a} \text{ Ans. (corresponds to } r = 2a)$$

The velocity at the hump ( $r = 2a$ ,  $\theta = 90^\circ$ ) then follows from Eq. (8.33):

$$U_{\text{max}} = U_\infty \sin 90^\circ \left[ 1 + \frac{a^2}{(2a)^2} \right] \text{ or } \mathbf{U_{\text{max}} = \frac{5}{4}U_\infty} \text{ Ans.}$$

**8.51** Modify Prob. 8.50 above as follows: Let the bump be such that  $U_{\text{max}} = 1.5U_\infty$ . Find (a) the upstream elevation  $h$ ; and (b) the height  $Z$  of the bump.

**Solution:** We use the analysis but modify it for unknown bump height  $Z$ :

$$\text{At } \theta = 90^\circ, r = h + Z: U_{\max} = 1.5 U_\infty = U_\infty \sin 90^\circ \left[ 1 + \left( \frac{a}{h+Z} \right)^2 \right], \text{ solve } h + Z = a\sqrt{2}$$

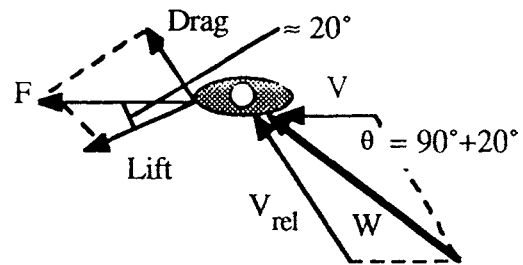
$$\text{Then } \psi = U_\infty h = U_\infty \sin 90^\circ \left( h + Z - \frac{a^2}{h+Z} \right), \text{ solve } h = Z = \frac{a}{\sqrt{2}} \text{ Ans.}$$

**8.52** The Flettner-rotor sailboat in Fig. E8.2 has a water drag coefficient of 0.006 based on a wetted area of 45 ft<sup>2</sup>. If the rotor spins at 220 rev/min, find the maximum boat speed that can be achieved in 15 mi/h winds. Find the optimum wind angle.



Fig. E8.2

**Solution:** Recall that the rotor has a diameter of 2.5 ft and is 10 ft high. Standard air density is 0.00238 slug/ft<sup>3</sup>. As in Ex. 8.2, estimate  $C_L \approx 3.3$  and  $C_D \approx 1.2$ . If the boat speed is  $V$  and the wind is  $W$ , the relative velocity  $V_{\text{rel}}$  is shown in the figure at right. Thrust = drag:



$$F = (C_L^2 + C_D^2)^{1/2} \frac{\rho}{2} V_{\text{rel}}^2 DL$$

$$= \text{Boat drag} = C_{d,\text{boat}} \frac{\rho_{\text{water}}}{2} V^2 A_{\text{wetted}},$$

$$\text{or: } [(3.3)^2 + (1.2)^2]^{1/2} \left( \frac{0.00238}{2} \right) V_{\text{rel}}^2 (2.5)(10) = (0.006) \left( \frac{1.99}{2} \right) V^2 (45),$$

$$\text{or: } V_{\text{rel}} = 1.604V$$

Convert  $W = 15 \text{ mi/h} = 22 \text{ ft/s}$ . As shown in the figure, the angle between the wind lift and wind drag is  $\tan^{-1}(C_D/C_L) = \tan^{-1}(1.2/3.3) \approx 20.0^\circ$ . Then, by geometry, the angle  $\theta$  between the relative wind and the boat speed (see figure above) is  $\theta = 180 - 70 = 110^\circ$ . The law of cosines, applied to the wind-vector triangle above, then determines the boat speed:

$$W^2 = V^2 + V_{\text{rel}}^2 - 2VV_{\text{rel}}\cos\theta,$$

$$\text{or: } (22)^2 = V^2 + (1.604V)^2 - 2V(1.604V)\cos(110^\circ)$$

$$\text{Solve for } V_{\text{boat}} \approx 10.2 \frac{\text{ft}}{\text{s}} \text{ Ans.}$$

For this “optimum” condition (which directs the resultant wind force along the keel or path of the boat), the angle  $\beta$  between the wind and the boat direction (see figure on the previous page) is

$$\frac{\sin \beta}{1.604(10.2)} = \frac{\sin(110^\circ)}{22}, \quad \text{or: } \beta \approx 44^\circ \quad \text{Ans.}$$

**8.53** Modify Prob. P8.52 as follows. For the same sailboat data, find the wind velocity, in mi/h, which will drive the boat at an optimum speed of **8 kn** parallel to its keel.

**Solution:** Convert 8 knots = 13.5 ft/s. Again estimate  $C_L \approx 3.3$  and  $C_D \approx 1.2$ . The geometry is the same as in Prob. P8.52, hence  $V_{rel}$  still equals  $1.604V = 21.66$  ft/s. The law of cosines still holds for the velocity diagram in the figure:

$$W^2 = V^2 + V_{rel}^2 - 2VV_{rel} \cos \theta = (13.5)^2 + (21.66)^2 - 2(13.5)(21.66) \cos(110^\circ) = 851 \text{ ft}^2/\text{s}^2$$

$$\text{Solve for } W_{wind} = 29.2 \text{ ft/s} = \mathbf{19.9 \text{ mi/h}} \quad \text{Ans.}$$

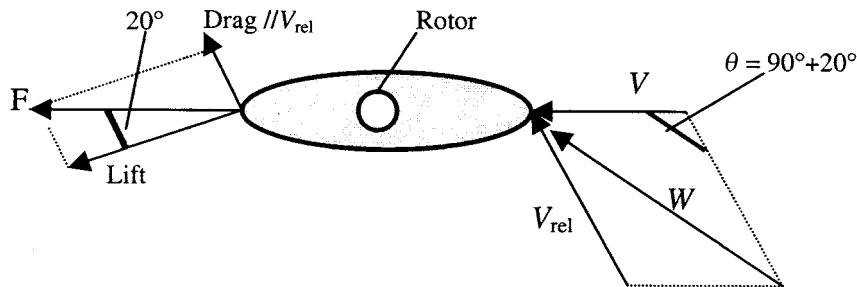


Fig. P8.52

**8.54** The original Flettner rotor ship was approximately 100 ft long, displaced 800 tons, and had a wetted area of 3500 ft<sup>2</sup>. As sketched in Fig. P8.54, it had two rotors 50 ft high and 9 ft in diameter rotating at 750 r/min, which is far outside the range of Fig. 8.11. The measured lift and drag coefficients for each rotor were about 10 and 4, respectively. If the ship is moored and subjected to a crosswind of 25 ft/s, as in Fig. P8.54, what will the wind force parallel and normal to the ship centerline be? Estimate the power required to drive the rotors.

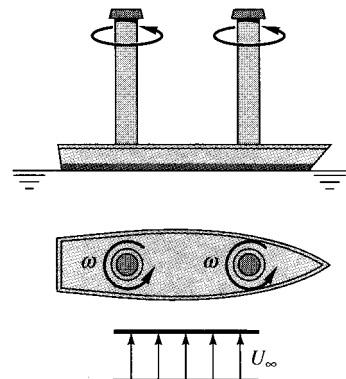


Fig. P8.54

**Solution:** For sea-level air take  $\rho = 0.00238$  slug/ft<sup>3</sup> and  $\mu = 3.71\text{E-}7$  slug/ft·s. Then compute the forces:

$$\begin{aligned} \text{Lift} &= C_L \frac{\rho}{2} U_\infty^2 DL \\ &= 10 \left( \frac{0.00238}{2} \right) (25)^2 (9 \text{ ft})(50 \text{ ft}) \times (2 \text{ rotors}) \approx \mathbf{6700 \text{ lbf}} \text{ (parallel) } \textit{Ans.} \end{aligned}$$

$$\text{Drag} = (4/10)\text{Lift} \approx \mathbf{2700 \text{ lbf}} \text{ (normal) } \textit{Ans.}$$

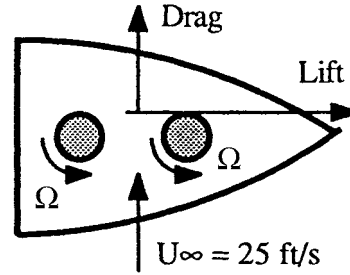
We don't have any *formulas* in the book for the (viscous) torque of a rotating cylinder (you could find results in refs. 1 and 2 of Chap. 7). As a good approximation, assume the cylinder simulates a flat plate of length  $2\pi R = 2\pi(4.5) = 28.3$  ft. Then the shear stress is:

$$\tau_w = C_f \frac{\rho}{2} U^2 \approx \frac{0.027}{\text{Re}_L^{1/7}} \frac{\rho}{2} (\Omega R)^2, \quad \Omega R = 750 \left( \frac{2\pi}{60} \right) (4.5) = 353 \frac{\text{ft}}{\text{s}}, \text{ and}$$

$$\text{Re}_L = \frac{0.00238(353)(28.3)}{3.71\text{E-}7} \approx 6.42\text{E}7, \quad \text{whence } \tau_w \approx \mathbf{0.308} \frac{\text{lbf}}{\text{ft}^2}$$

$$\text{Then Torque} = \tau_w(\pi D L)R = 0.308\pi(9)(50)(4.5) \approx 1958 \text{ ft}\cdot\text{lbf}$$

$$\text{Total power} = T\Omega = (1958) \left( 750 \frac{2\pi}{60} \right) \times (2 \text{ rotors}) \div 550 \frac{\text{hp}}{\text{ft}\cdot\text{lbf/s}} \approx \mathbf{560 \text{ hp}} \textit{ Ans.}$$



**8.55** Assume that the Flettner rotor ship of Fig. P8.54 has a water-resistance coefficient of 0.005. How fast will the ship sail in seawater at 20°C in a 20 ft/s wind if the keel aligns itself with the resultant force on the rotors? [This problem involves relative velocities.]

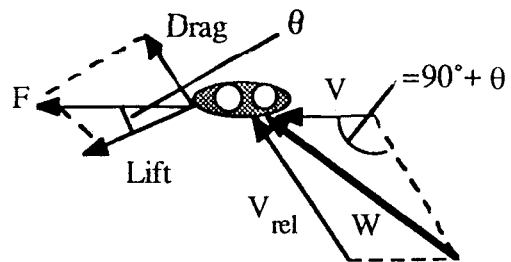


Fig. P8.55

**Solution:** For air, take  $\rho = 0.00238$  slug/ft<sup>3</sup>. For seawater, take  $\rho = 1.99$  slug/ft<sup>3</sup> and  $\mu = 2.09\text{E-}5$  slug/ft·s. Recall  $D = 9$  ft,  $L = 50$  ft, 2 rotors at 750 rev/min,  $C_L \approx 10.0$ ,  $C_D \approx 4.0$ . In the sketch above, the drag and lift combine along the ship's keel. Then

$$\theta = \tan^{-1} \left( \frac{4}{10} \right) \approx 21.8^\circ, \quad \text{so angle between } \mathbf{V} \text{ and } \mathbf{V}_{\text{rel}} = 90 + \theta \approx \mathbf{111.8^\circ}$$

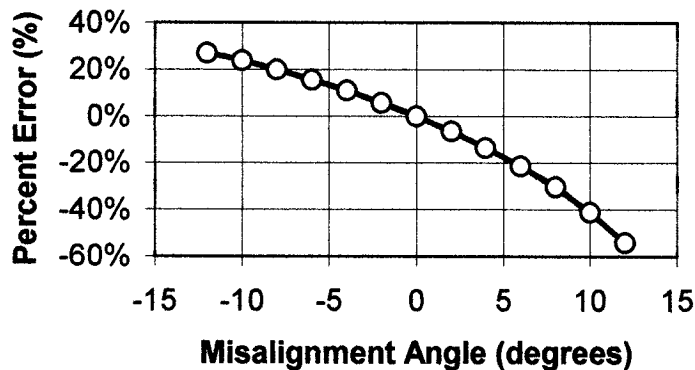
$$\begin{aligned} \text{Thrust } F &= [(10)^2 + (4)^2]^{1/2} \left( \frac{0.00238}{2} \right) V_{\text{rel}}^2 (9)(50)(2 \text{ rotors}) \\ &= \text{Drag} = C_d (\rho/2) V^2 A_{\text{wetted}} = (0.005)(1.99/2)(3500)V^2, \quad \text{solve } V_{\text{rel}} \approx 1.23V \\ \text{Law of cosines: } W^2 &= V^2 + V_{\text{rel}}^2 - 2VV_{\text{rel}} \cos(\theta + 90^\circ), \\ \text{or: } (20)^2 &= V^2 + (1.23V)^2 - 2V(1.23V) \cos(111.8^\circ), \quad \text{solve for } V_{\text{ship}} \approx 10.8 \frac{\text{ft}}{\text{s}} \quad \text{Ans.} \end{aligned}$$

**8.56** A proposed freestream velocimeter would use a cylinder with pressure taps at  $\theta = 180^\circ$  and at  $150^\circ$ . The pressure difference would be a measure of stream velocity  $U_\infty$ . However, the cylinder must be aligned so that one tap exactly faces the freestream. Let the misalignment angle be  $\delta$ , that is, the two taps are at  $(180^\circ + \delta)$  and  $(150^\circ + \delta)$ . Make a plot of the percent error in velocity measurement in the range  $-20^\circ < \delta < +20^\circ$  and comment on the idea.

**Solution:** Recall from Eq. (8.34) that the surface velocity on the cylinder equals  $2U_\infty \sin \theta$ . Apply Bernoulli's equation at both points,  $180^\circ$  and  $150^\circ$ , to solve for stream velocity:

$$\begin{aligned} p_1 + \frac{\rho}{2} [2U_\infty \sin(180^\circ + \delta)]^2 &= p_2 + \frac{\rho}{2} [2U_\infty \sin(150^\circ + \delta)]^2, \\ \text{or: } U_\infty &= \frac{\sqrt{\Delta p/2\rho}}{\sqrt{\sin^2(150^\circ + \delta) - \sin^2(180^\circ + \delta)}} \end{aligned}$$

The error is zero when  $\delta = 0^\circ$ . Thus we can plot the percent error versus  $\delta$ . When  $\delta = 0^\circ$ , the denominator above equals 0.5. When  $\delta = 5^\circ$ , the denominator equals 0.413, giving an error on the low side of  $(0.413/0.5) - 1 = -17\%$ ! The plot below shows that this is a very poor idea for a velocimeter, since even a small misalignment causes a large error.



Problem 8.56

**8.57** In principle, it is possible to use rotating cylinders as aircraft wings. Consider a cylinder 30 cm in diameter, rotating at 2400 rev/min. It is to lift a 55-kN airplane flying at 100 m/s. What should the cylinder length be? How much power is required to maintain this speed? Neglect end effects on the rotating wing.

**Solution:** Assume sea-level air,  $\rho = 1.23 \text{ kg/m}^3$ . Use Fig. 8.11 for lift and drag:

$$\frac{a\omega}{U_\infty} = \frac{(0.15)[2400(2\pi/60)]}{100} \approx 0.38. \quad \text{Fig. 8.11: Read } C_L \approx 1.8, C_D \approx 1.1$$

$$\text{Then Lift} = 55000 \text{ N} = C_L \frac{\rho}{2} U_\infty^2 DL = (1.8) \left( \frac{1.23}{2} \right) (100)^2 (0.3)L,$$

$$\text{solve } \mathbf{L} \approx \mathbf{17 \text{ m}} \quad \text{Ans.}$$

$$\text{Drag} = C_D \frac{\rho}{2} U_\infty^2 DL = (1.1) \left( \frac{1.23}{2} \right) (100)^2 (0.3)(17) \approx 33600 \text{ N}$$

$$\text{Power required} = FU = (33600)(100) \approx \mathbf{3.4 \text{ MW!}} \quad \text{Ans.}$$

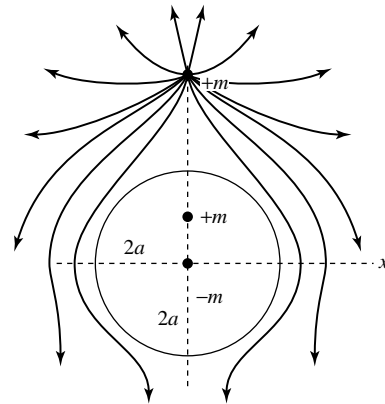
The power requirements are ridiculously high. This airplane has way too much drag.

**8.58** Plot the streamlines due to a line sink ( $-m$ ) at the origin, plus line sources ( $+m$ ) at  $(a, 0)$  and  $(4a, 0)$ . *Hint:* A cylinder of radius  $2a$  appears.

**Solution:** The overall stream function is

$$\psi = m \tan^{-1} \left( \frac{y-4a}{x} \right) + m \tan^{-1} \left( \frac{y-a}{x} \right) - m \tan^{-1} (y/x)$$

The cylinder shape, of radius  $2a$ , is the streamline  $\psi = -\pi/2$ . *Ans.*



**Fig. P8.58**

**8.59** By analogy with Prob. 8.58 above, plot the streamlines due to counterclockwise line vortices  $+K$  at  $(0, 0)$  and  $(4a, 0)$  plus a clockwise line vortex ( $-K$ ) at  $(a, 0)$ . *Hint:* Again a cylinder of radius  $2a$  appears.

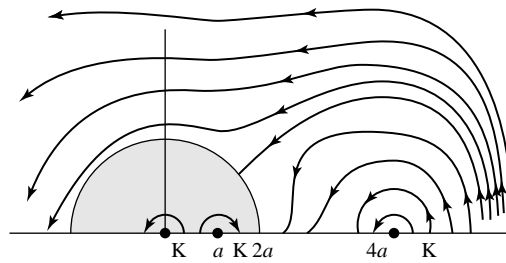


Fig. P8.59

**8.60** One of the corner-flow patterns of Fig. 8.15 is given by the cartesian stream function  $\psi = A(3yx^2 - y^3)$ . Which one? Can this correspondence be proven from Eq. (8.49)?

**Solution:** This  $\psi$  is Fig. 8.15a, **flow in a  $60^\circ$  corner**. [Its velocity potential was given earlier Eq. (8.49) of the text.] The trigonometric form (Eq. 8.49 for  $n = 3$ ) is

$$\psi = Ar^3 \sin(3\theta), \quad \text{but } \sin(3\theta) \equiv 3 \sin \theta \cos^2 \theta - \sin^3 \theta.$$

Introducing  $y = r \sin \theta$  and  $x = r \cos \theta$ , we obtain  $\psi = A(3yx^2 - y^3)$  Ans.

**8.61** Plot the streamlines of Eq. (8.49) in the upper right quadrant for  $n = 4$ . How does the velocity increase with  $x$  outward along the  $x$  axis from the origin? For what corner angle and value of  $n$  would this increase be linear in  $x$ ? For what corner angle and  $n$  would the increase be as  $x^5$ ?

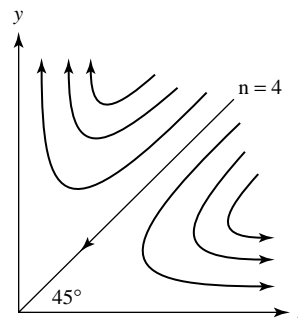


Fig. P8.61

**Solution:** For  $n = 4$ , we have **flow in a  $45^\circ$  corner**, as shown. Compute

$$n = 4: \quad \psi = Ar^4 \sin(4\theta), \quad v_r = \frac{1}{r} \frac{\partial \psi}{\partial \theta} = 4Ar^3 \cos(4\theta)$$

Along the  $x$ -axis,  $\theta = 0$ ,  $r = x$ ,  $v_r = u = (\text{const})x^3$  Ans. (a)

In general, for any  $n$ , the flow along the  $x$ -axis is  $u = (\text{const})x^{n-1}$ . Thus  $u$  is linear in  $x$  for  $n = 2$  (a  $90^\circ$  corner). Ans. (b). And  $u = Cx^5$  if  $n = 6$  (a  $30^\circ$  corner). Ans. (c)



**8.62** Combine stagnation flow, Fig. 8.14b, with a source at the origin:

$$f(z) = Az^2 + m \ln(z)$$

Plot the streamlines for  $m = AL^2$ , where  $L$  is a length scale. Interpret.

**Solution:** The imaginary part of this complex potential is the stream function:

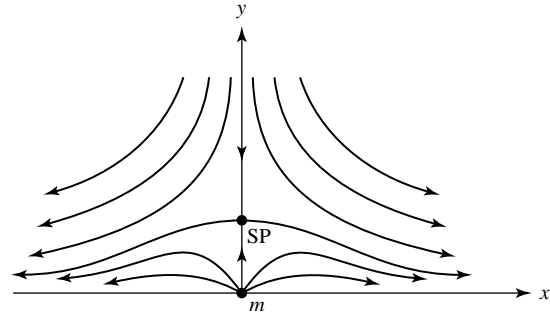


Fig. P8.62

$$\psi = 2Axy + m \tan^{-1}\left(\frac{y}{x}\right), \quad \text{with } m = AL^2$$

The streamlines are shown on the previous page. The source pushes the oncoming stagnation flow away from the vicinity of the origin. There is a stagnation point above the source, at  $(x, y) = (0, L/\sqrt{2})$ . Thus we have “stagnation flow near a bump.” *Ans.*

**8.63** The superposition in Prob. 8.62 above leads to stagnation flow near a curved *bump*, in contrast to the flat wall of Fig. 8.15b. Determine the maximum height  $H$  of the bump as a function of the constants  $A$  and  $m$ . The bump crest is a stagnation point:

$$v_{\text{bump crest}} = -2AH + \frac{m}{H} = 0 \quad \text{whence } H_{\text{bump}} = \sqrt{\frac{m}{2A}} \quad \text{Ans.}$$

**8.64** Consider the polar-coordinate velocity potential  $\phi = Br^{1.2} \cos(1.2\theta)$ , where  $B$  is a constant. (a) Determine whether  $\nabla^2 \phi = 0$ . If so, (b) find the associated stream function  $\psi(r, \theta)$  and (c) plot the full streamline which includes the x-axis ( $\theta = 0$ ) and interpret.

**Solution:** (a) It is laborious, but the velocity potential satisfies Laplace’s equation in polar coordinates:

$$\nabla^2 \phi = \frac{1}{r} \frac{\partial}{\partial r} \left( r \frac{\partial \phi}{\partial r} \right) + \frac{1}{r^2} \frac{\partial}{\partial \theta} \left( \frac{\partial^2 \phi}{\partial \theta^2} \right) \equiv 0 \quad \text{if } \phi = Br^{1.2} \cos(1.2\theta) \quad \text{Ans. (a)}$$

(b) This example is one of the family of “corner flow” solutions in Eq. (8.49). Thus:

$$\psi = Br^{1.2} \sin(1.2\theta) \quad \text{Ans. (b)}$$

(c) This function represents **flow around a 150° corner**, as shown below. *Ans.* (c)

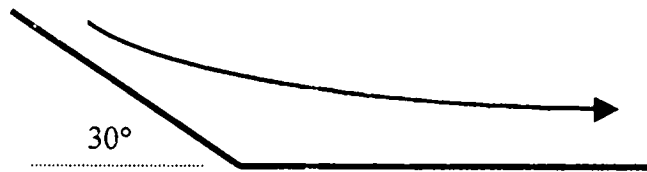


Fig. P8.64

**8.65** Potential flow past a wedge of half-angle  $\theta$  leads to an important application of laminar-boundary-layer theory called the *Falkner-Skan flows* [Ref. 15 of Chap. 8, pp. 242–247]. Let  $x$  denote distance along the wedge wall, as in Fig. P8.65, and let  $\theta = 10^\circ$ . Use Eq. (8.49) to find the variation of surface velocity  $U(x)$  along the wall. Is the pressure gradient adverse or favorable?

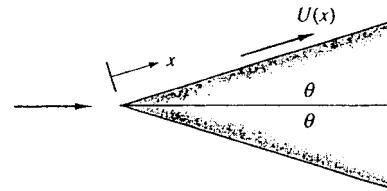


Fig. P8.65

**Solution:** As discussed above, all wedge flows are “corner flows” and have a velocity along the wall of the form  $u = (\text{const})x^{n-1}$ , where  $n = \pi/(\text{turning angle})$ . In this case, the turning angle is  $\beta = (\pi - \theta)$ , where  $\theta = 10^\circ = \pi/18$ . Hence the proper value of  $n$  here is:

$$n = \frac{\pi}{\beta} = \frac{\pi}{\pi - \pi/18} = \frac{18}{17}, \quad \text{hence } U = Cx^{n-1} = Cx^{1/17} \quad (\text{favorable gradient}) \quad \text{Ans.}$$

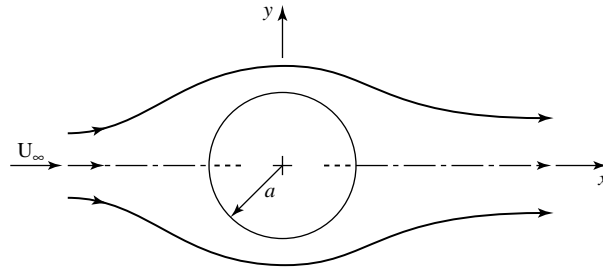
**8.66** The inviscid velocity along the wedge in Prob. 8.65 has the form  $U(x) = Cx^m$ , where  $m = n - 1$  and  $n$  is the exponent in Eq. (8.49). Show that, for any  $C$  and  $n$ , computation of the laminar boundary-layer by Thwaites’ method, Eqs. (7.53) and (7.54), leads to a unique value of the Thwaites parameter  $\lambda$ . Thus wedge flows are called *similar* [Ref. 15 of Chap. 8, p. 244].

**Solution:** The momentum thickness is computed by Eq. (7.54), assuming  $\theta_0 = 0$ :

$$\theta^2 = \frac{0.45\nu}{U^6} \int_0^x U^5 dx = \frac{0.45\nu}{C^6 x^{6m}} \int_0^x C^5 x^{5m} dx = \frac{0.45\nu x^{1-m}}{C(5m+1)} \quad \text{Then use Eq. (7.53):}$$

$$\lambda = \frac{\theta^2}{\nu} \frac{dU}{dx} = \left( \frac{0.45x^{1-m}}{C(5m+1)} \right) (mCx^{m-1}) = \frac{0.45m}{5m+1} \quad (\text{independent of } C \text{ and } m) \quad \text{Ans.}$$

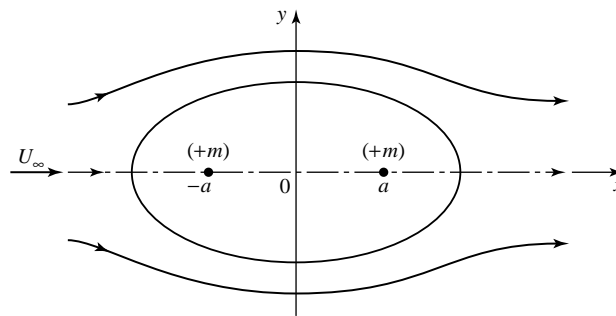
**8.67** Investigate the complex potential function  $f(z) = U_\infty(z + a^2/z)$ , where  $a$  is a constant, and interpret the flow pattern.



**Fig. P8.67**

**Solution:** This represents flow past a **circular cylinder** of radius  $a$ , with stream function and velocity potential identical to the expressions in Eqs. (8.31) and (8.32) with  $K = 0$ . [There is no circulation.]

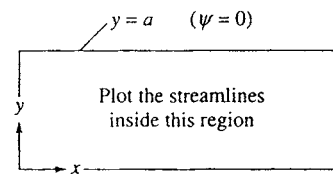
**8.68** Investigate the complex potential function  $f(z) = U_\infty z + m \ln[(z + a)/(z - a)]$ , where  $m$  and  $a$  are constants, and interpret the flow pattern.



**Fig. P8.68**

**Solution:** This represents flow past a **Rankine oval**, with stream function identical to that given by Eq. (8.29).

**8.69** Investigate the complex potential function  $f(z) = A \cosh(\pi z/a)$ , where  $a$  is a constant, and plot the streamlines inside the region shown in Fig. P8.69. What hyphenated French word might describe this flow pattern?



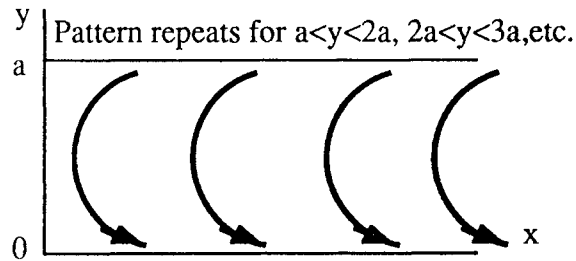
**Fig. P8.69**

**Solution:** This potential splits into

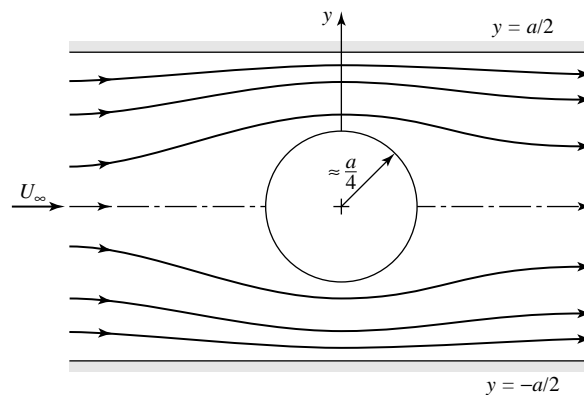
$$\psi = A \sinh(\pi x/a) \sin(\pi y/a)$$

$$\phi = A \cosh(\pi x/a) \cos(\pi y/a)$$

and represents flow in a “cul-de-sac” or blind alley.



**8.70** Show that the complex potential  $f(z) = U_\infty [z + (a/4) \coth(\pi z/a)]$  represents flow past an oval shape placed midway between two parallel walls  $y = \pm a/2$ . What is a practical application?



**Fig. P8.70**

**Solution:** The stream function of this flow is

$$\psi = U_\infty \left[ y - \frac{(a/4) \sin(2\pi y/a)}{\cosh(2\pi x/a) - \cos(2\pi y/a)} \right]$$

The streamlines are shown in the figure. The body shape, trapped between  $y = \pm a/2$ , is nearly a cylinder, with width  $a/2$  and height  $0.51a$ . A nice application is the estimate of wall “blockage” effects when a body (say, in a wind tunnel) is trapped between walls.

**8.71** Figure P8.71 shows the streamlines and potential lines of flow over a thin-plate weir as computed by the complex potential method. Compare qualitatively with Fig. 10.16a. State the proper boundary conditions at all boundaries. The velocity potential has equally spaced values. Why do the flow-net “squares” become smaller in the overflow jet?

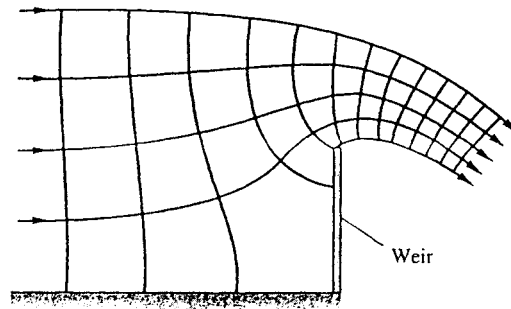
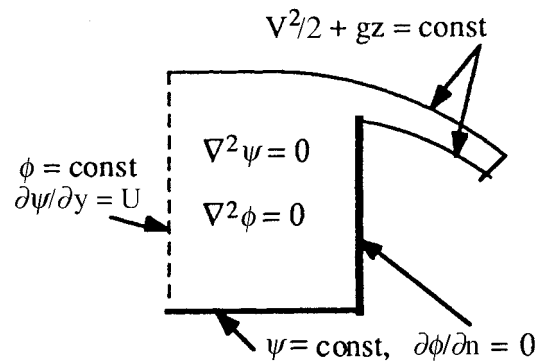


Fig. P8.71

**Solution:** Solve Laplace’s equation for either  $\psi$  or  $\phi$  (or both), find the velocities  $u = \partial\phi/\partial x$ ,  $v = \partial\phi/\partial y$ , force the (constant) pressure to match Bernoulli’s equation on the free surfaces (whose shape is *a priori* unknown). The squares become smaller in the overfall jet because the velocity is increasing.



**8.72** Use the method of images to construct the flow pattern for a source  $+m$  near two walls, as in Fig. P8.72. Sketch the velocity distribution along the lower wall ( $y=0$ ). Is there any danger of flow separation along this wall?

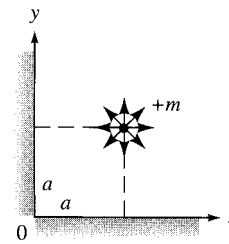
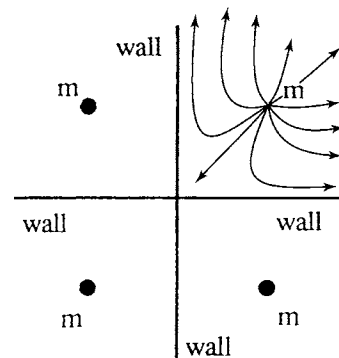


Fig. P8.72

**Solution:** This pattern is the same as that of Prob. 8.28. It is created by placing **four** identical sources at  $(x, y) = (\pm a, \pm a)$ , as shown. Along the wall ( $x \geq 0, y = 0$ ), the velocity first increases from 0 to a maximum at  $x = a$ . Then the velocity *decreases* for  $x > a$ , which is an *adverse* pressure gradient—**separation may occur**.  
*Ans.*



**8.73** Set up an image system to compute the flow of a source at *unequal* distances from *two* walls, as shown in Fig. P8.73. Find the point of maximum velocity on the  $y$ -axis.

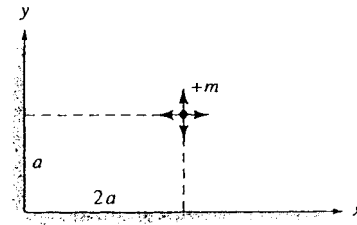
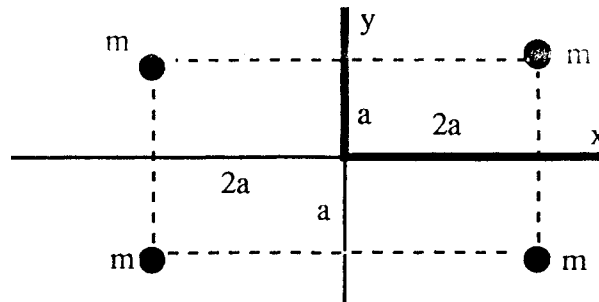


Fig. P8.73

**Solution:** Similar to Prob. 8.72 on the previous page, we place identical sources ( $+m$ ) at the symmetric (but non-square) positions  $(x, y) = (\pm 2a, \pm a)$  as shown below. The induced velocity along the wall ( $x > 0, y = 0$ ) has the form

$$U = \frac{2m(x+2a)}{(x+2a)^2 + a^2} + \frac{2m(x-2a)}{(x-2a)^2 + a^2}$$



This velocity has a maximum (to the *right*) at  $x \approx 2.93a$ ,  $U \approx 1.387 m/a$ . *Ans.*

**8.74** A positive line vortex  $K$  is trapped in a corner, as in Fig. P8.74. Compute the total induced velocity at point B,  $(x, y) = (2a, a)$ , and compare with the induced velocity when no walls are present.

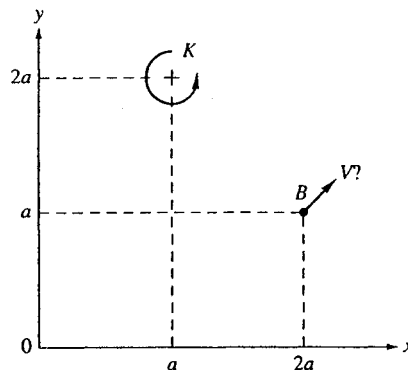
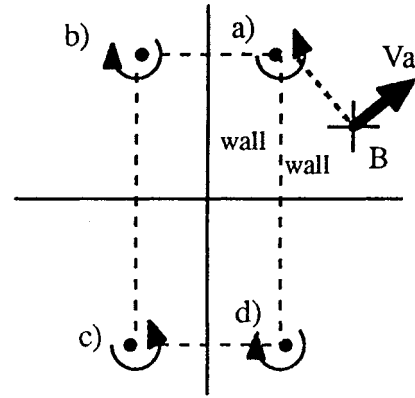


Fig. P8.74

**Solution:** The two walls are created by placing vortices, as shown at right, at  $(x, y) = (\pm a, \pm 2a)$ . With only one vortex (#a), the induced velocity  $\mathbf{V}_a$  would be

$$\mathbf{V}_a = \frac{K}{2a} \mathbf{i} + \frac{K}{2a} \mathbf{j}, \quad \text{or} \quad \frac{K}{a\sqrt{2}} \text{ at } 45^\circ \nearrow$$

as shown at right. With the walls, however, we have to add this vectorially to the velocities induced by vortices b, c, and d.



$$\text{With walls: } \mathbf{V} = \sum \mathbf{V}_{a,b,c,d} = \frac{K}{a} \left( \frac{1}{2} - \frac{1}{10} - \frac{1}{6} + \frac{3}{10} \right) \mathbf{i} + \frac{K}{a} \left( \frac{1}{2} - \frac{3}{10} + \frac{1}{6} - \frac{1}{10} \right) \mathbf{j},$$

$$\text{or } \mathbf{V}_B = 0.533 \frac{K}{a} \mathbf{i} + 0.267 \frac{K}{a} \mathbf{j} = \frac{8K}{15a} \mathbf{i} + \frac{4K}{15a} \mathbf{j} \quad \text{Ans.}$$

The presence of the walls thus causes a significant change in the magnitude and direction of the induced velocity at point B.

**8.75** Using the four-source image pattern needed to construct the flow near a corner shown in Fig. P8.72, find the value of the source strength  $m$  which will induce a wall velocity of 4.0 m/s at the point  $(x, y) = (a, 0)$  just below the source shown, if  $a = 50$  cm.

**Solution:** The flow pattern is formed by four equal sources  $m$  in the 4 quadrants, as in the figure at right. The sources above and below the point  $A(a, 0)$  cancel each other at  $A$ , so the velocity at  $A$  is caused only by the two left sources. The velocity at  $A$  is the sum of the two horizontal components from these 2 sources:

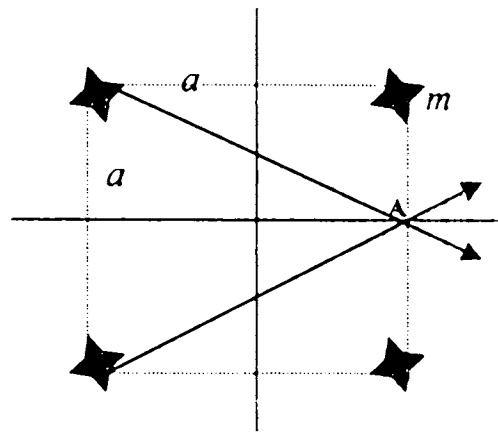


Fig. P8.75

$$V_A = 2 \frac{m}{\sqrt{a^2 + (2a)^2}} \frac{2a}{\sqrt{a^2 + (2a)^2}} = \frac{4ma}{5a^2} = \frac{4m}{5(0.5m)} = 4 \frac{m}{s} \quad \text{if } m = 2.5 \frac{m^2}{s} \quad \text{Ans.}$$

**8.76** Use the method of images to approximate the flow past a cylinder at distance  $4a$  from the wall, as in Fig. P8.76. To illustrate the effect of the wall, compute the velocities at points A, B, C, and D, comparing with a cylinder flow in an infinite expanse of fluid (without walls).

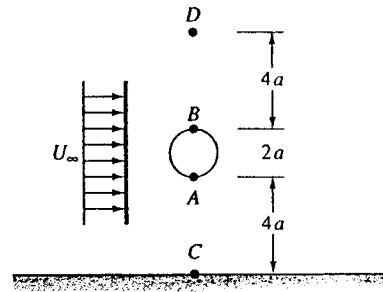


Fig. P8.76

**Solution:** Let doublet #1 be above the wall, as shown, and let image doublet #2 be below the wall, at  $(x, y) = (0, -5a)$ . Then, at any point on the  $y$ -axis, the total velocity is

$$V_{x=0} = -v_{\theta}|_{90^\circ} = U_{\infty} [1 + (a/r_1)^2 + (a/r_2)^2]$$

Since the images are  $10a$  apart, the cylinders are only slightly out-of-round and the velocities at A, B, C, D may be tabulated as follows:

Point:	A	B	C	D
$r_1$ :	$a$	$a$	$5a$	$5a$
$r_2$ :	$9a$	$11a$	$5a$	$15a$
$V_{\text{walls}}$ :	$2.012U_{\infty}$	$2.008U_{\infty}$	$1.080U_{\infty}$	$1.044U_{\infty}$
$V_{\text{no walls}}$ :	$2.0U_{\infty}$	$2.0U_{\infty}$	$1.04U_{\infty}$	$1.04U_{\infty}$

The presence of the walls causes only a slight change in the velocity pattern.

**8.77** Discuss how the flow pattern of Prob. 8.58 might be interpreted to be an *image*-system construction for circular walls. Why are there two images instead of one?

**Solution:** The missing “image sink” in this problem is at  $y = +\infty$  so is not shown. If the source is placed at  $y = a$  and the image source at  $y = b$ , the radius of the cylinder will be  $R = \sqrt{ab}$ . For further details about this type of imaging, see Chap. 8, Ref. 3, p. 230.

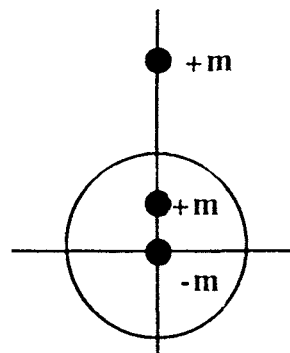


Fig. P8.77



**8.78** Indicate the system of images needed to construct the flow of a uniform stream past a Rankine half-body centered between parallel walls, as in Fig. P8.78. For the particular dimensions shown, estimate the position  $\ell$  of the nose of the resulting half-body.

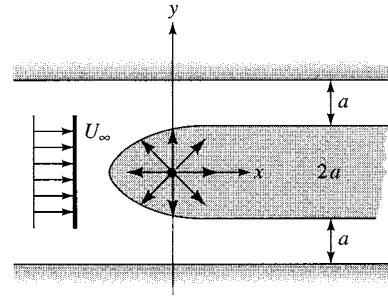


Fig. P8.78

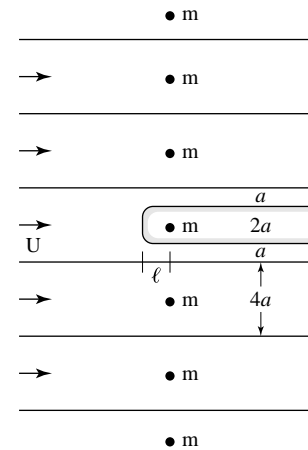
**Solution:** A body between *two* walls is created by an infinite array of sources, as shown at right. The source strength  $m$  fits the half-body size “ $2a$ ”:

$$Q = U(2a) = 2\pi m, \quad \text{or: } \mathbf{m = Ua/\pi}$$

The distance  $\ell$  to the nose denotes the stagnation point, where

$$U = \frac{m}{L} \left[ 1 + \frac{2}{1+(4a/L)^2} + \frac{2}{1+(8a/L)^2} + \dots \right]$$

where  $m = Ua/\pi$ , as shown. We solve this series summation for  $\ell \approx \mathbf{0.325a}$ . *Ans.*



**8.79** Indicate the system of images needed to simulate the flow of a line source placed unsymmetrically between two parallel walls, as in Fig. P8.79. Compute the velocity on the lower wall at  $x = +a$ . How many images are needed to establish this velocity to within  $\pm 1\%$ ?

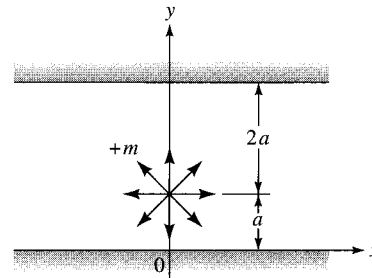
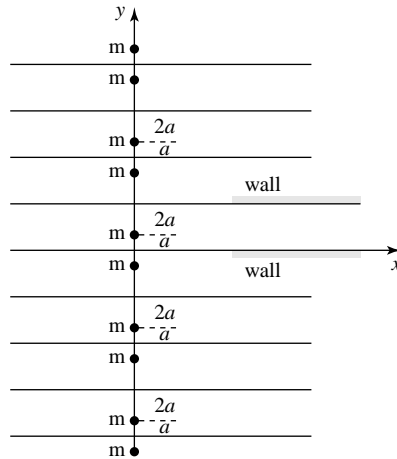


Fig. P8.79

**Solution:** To form a wall at  $y = 0$  and also at  $y = 3a$ , with the source located at  $(0, a)$ , one needs an infinite number of **pairs** of sources, as shown. The velocity at  $(a, 0)$  is an



infinite sum:

$$u(a, 0) = \frac{2m}{a} \left[ \frac{1}{1^2 + 1} + \frac{1}{5^2 + 1} + \frac{1}{7^2 + 1} + \frac{1}{11^2 + 1} + \frac{1}{13^2 + 1} + \dots \right]$$

Accuracy within 1% is reached after 18 terms:  $u(a, 0) \approx 1.18 m/a$ . *Ans.*

**8.80** The beautiful expression for lift of a two-dimensional airfoil, Eq. (8.69), arose from applying the *Joukowski transformation*,  $\zeta = z + a^2/z$ , where  $z = x + iy$  and  $\zeta = \eta + i\beta$ . The constant  $a$  is a length scale. The theory transforms a certain circle in the  $z$  plane into an airfoil in the  $\zeta$  plane. Taking  $a = 1$  unit for convenience, show that (a) a circle with center at the origin and radius  $>1$  will become an *ellipse* in the  $\zeta$  plane, and (b) a circle with center at  $x = -\varepsilon \ll 1, y = 0$ , and radius  $(1 + \varepsilon)$  will become an *airfoil* shape in the  $\zeta$  plane. *Hint:* Excel is excellent for solving this problem.

**Solution:** Introduce  $z = x + iy$  into the transformation and find real and imaginary parts:

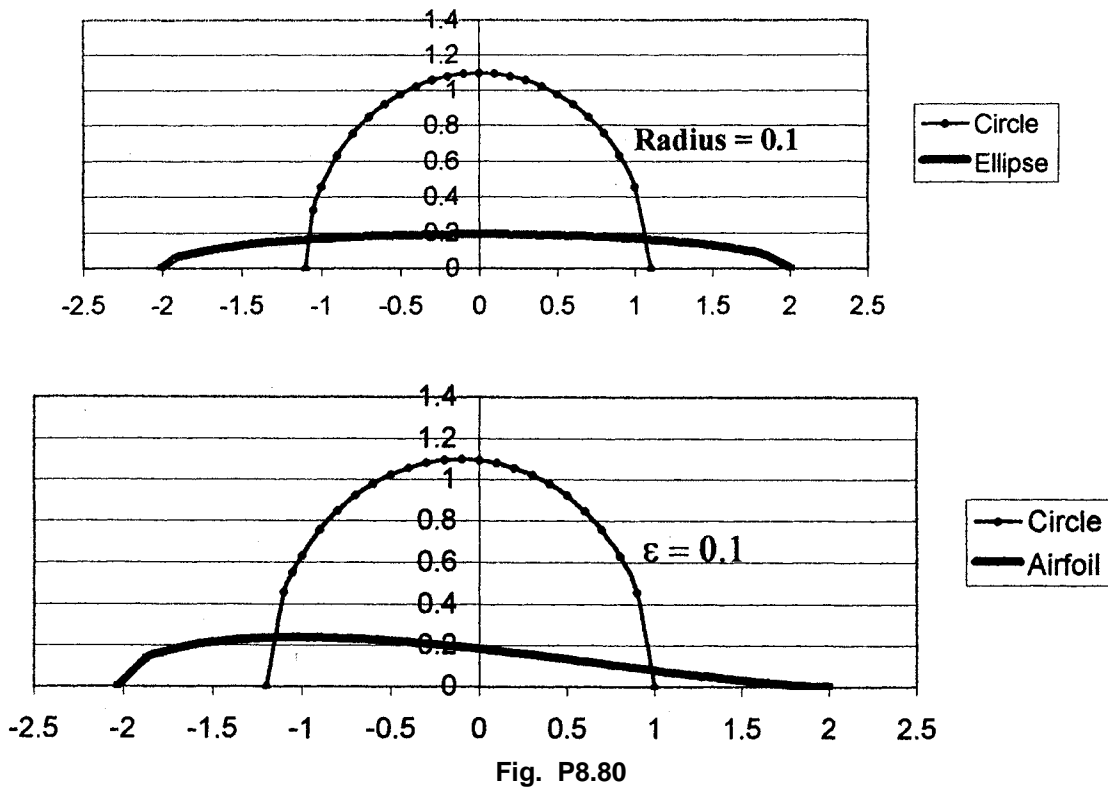
$$\zeta = (x + iy) + \frac{1}{x + iy} \left( \frac{x - iy}{x - iy} \right) = x \left( 1 + \frac{1}{x^2 + y^2} \right) + iy \left( 1 - \frac{1}{x^2 + y^2} \right) = \eta + i\beta$$

Thus  $\eta$  and  $\beta$  are simple functions of  $x$  and  $y$ , as shown. Thus, if the circle in the  $z$  plane has radius  $C > 1$ , the coordinates in the  $\zeta$  plane will be

$$\eta = x \left( 1 + \frac{1}{C^2} \right) \quad \beta = y \left( 1 - \frac{1}{C^2} \right)$$

The circle in the  $z$  plane will transform into an *ellipse* in the  $\zeta$  plane of major axis  $(1 + 1/C^2)$  and minor axis  $(1 - 1/C^2)$ . This is shown on the next page for  $C = 1.1$ . If the

circle center is at  $(-\varepsilon, 0)$  and radius  $C = 1 + \varepsilon$ , an *airfoil* will form, because a sharp (trailing) edge will form on the right and a fat (elliptical) leading edge will form on the left. This is also shown below for  $\varepsilon = 0.1$ .



**8.81** A very wide NACA 4412 airfoil, with a chord of 75 cm, is tested in a sea-level wind tunnel at 45 m/s and found to have a lift of 65 lbf per foot of span. Estimate the angle of attack for this condition.

**Solution:** For sea-level air take  $\rho = 1.22 \text{ kg/m}^3$ . From Fig. 8.20 and Table 8.3, for the 4412 airfoil,  $\alpha_{ZL} \approx -4^\circ$  and  $dC_L/d\alpha \approx 6.0$ . The lift coefficient is computed from the measured lift and velocity. Convert 65 lbf/ft to 949 N/m and evaluate:

$$C_L = \frac{2(\text{Lift})}{\rho V^2 b C} = \frac{2(949 \text{ N/m})}{(1.22 \text{ kg/m}^3)(45 \text{ m/s})^2 (1 \text{ m})(0.75 \text{ m})} = 1.024 \approx 6.0 \sin(\alpha + 4.0^\circ)$$

Solve for  $\alpha = 9.8^\circ$  or better,  $\alpha \approx 10^\circ \pm 0.5^\circ$  Ans.

**8.82** The ultralight plane *Gossamer Condor* in 1977 was the first to complete the Kremer Prize figure-eight course solely under human power. Its wingspan was 29 m, with  $C_{av} = 2.3$  m and a total mass of 95 kg. Its drag coefficient was approximately 0.05. The pilot was able to deliver 1/4 horsepower to propel the plane. Assuming two-dimensional flow at sea level, estimate (a) the cruise speed attained, (b) the lift coefficient; and (c) the horsepower required to achieve a speed of 15 knots.

**Solution:** For sea-level air, take  $\rho = 1.225 \text{ kg/m}^3$ . With  $C_D$  known, we may compute  $V$ :

$$\begin{aligned} \text{Power} &= F_{drag} V = \frac{1}{4} \text{hp}(745.7) = 186 \text{ W} = \left[ C_D \frac{\rho}{2} V^2 bC \right] V \\ &= 0.05 \left( \frac{1.225}{2} \right) V^2 (29)(2.3)V = 186; \end{aligned}$$

$$\text{Solve } V^3 = 91.3 \quad \text{or} \quad \mathbf{V = 4.5 \frac{m}{s}} \quad \text{Ans. (a)}$$

Then, with  $V$  known, we may compute the lift coefficient from the known weight:

$$C_L = \frac{\text{weight}}{(\rho/2)V^2 bC} = \frac{95(9.81) \text{ N}}{(1.225/2)(4.5)^2 (29)(2.3)} = \mathbf{1.13} \quad \text{Ans. (b)}$$

Finally, compute the power if  $V = 15 \text{ knots} = 7.72 \text{ m/s}$ :

$$\begin{aligned} P &= FV = \left( C_D \frac{\rho}{2} V^2 bC \right) V = 0.05 \left( \frac{1.225}{2} \right) (7.72)^2 (29)(2.3)(7.72) \\ &= 940 \text{ W} = \mathbf{1.26 \text{ hp}} \quad \text{Ans. (c)} \end{aligned}$$

**8.83** Two-dimensional lift-drag data for the NACA 2412 airfoil with 2 percent camber (from Ref. 12) may be curve-fitted accurately as follows:

$$C_L \approx 0.178 + 0.109\alpha - 0.00109\alpha^2$$

$$C_D \approx 0.0089 + 1.97\text{E-}4\alpha + 8.45\text{E-}5\alpha^2 - 1.35\text{E-}5\alpha^3 + 9.92\text{E-}7\alpha^4$$

with  $\alpha$  in degrees in the range  $-4^\circ < \alpha < +10^\circ$ . Compare (a) the lift-curve slope and (b) the angle of zero lift with theory, Eq. (8.69). (c) Prepare a polar lift-drag plot and compare with Fig. 7.25.

**Solution:** The lift formula is not quite linear in  $\alpha$ , but a reasonable lift-curve slope and the zero-lift angle of attack may be computed as follows:

$$\left. \frac{dC_L}{d\alpha} \right|_{\alpha=0} = 0.109 \text{ per degree} \times \frac{180}{\pi} \approx \mathbf{6.25} \text{ per radian} \quad \text{Ans. (a)}$$

$$\text{Angle of zero lift: } 0.178 + 0.109\alpha - 0.00109\alpha^2 = 0 \quad \text{at } \alpha \approx \mathbf{-1.61^\circ} \quad \text{Ans. (b)}$$

$$\text{From Eq. (8.70) theory, } \alpha_{\text{zero lift}} = -\tan^{-1}[2(0.02)] \approx \mathbf{-2.3^\circ} \text{ (fair accuracy)}$$

The polar lift-drag curve is simply prepared by plotting lift versus drag for all  $\alpha$  in the given range  $-4^\circ < \alpha < 10^\circ$ . The curve is shown below, with negative lift omitted. It resembles the NACA 0009 foil in Fig. 7.25, except it has slightly less drag.

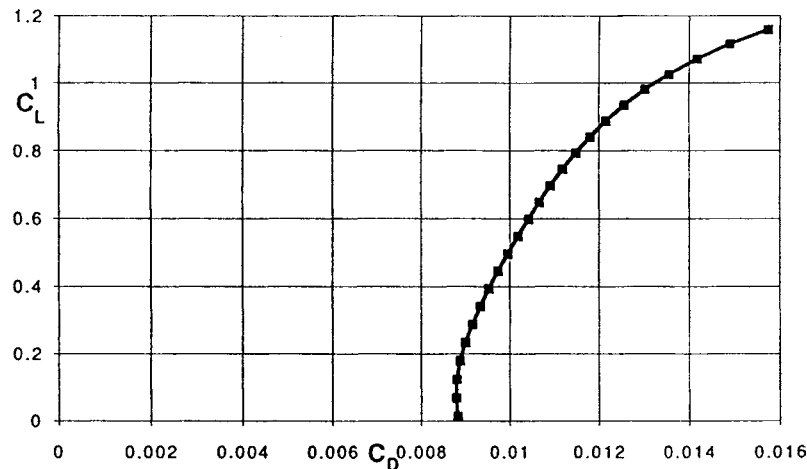


Fig. P8.83

**8.84** Reference 12 contains inviscid theory calculations for the surface velocity distributions  $V(x)$  over an airfoil, where  $x$  is the chordwise coordinate. A typical result for small angle of attack is shown below. Use these data, plus Bernoulli's equation, to estimate (a) the lift coefficient; and (b) the angle of attack if the airfoil is symmetric.

$x/c$	$V/U_\infty$ (upper)	$V/U_\infty$ (lower)
0.0	0.0	0.0
0.025	0.97	0.82
0.05	1.23	0.98
0.1	1.28	1.05
0.2	1.29	1.13
0.3	1.29	1.16
0.4	1.24	1.16
0.6	1.14	1.08
0.8	0.99	0.95
1.0	0.82	0.82

**Solution:** From Bernoulli's equation, the surface pressures may be computed, whence the lift coefficient then follows from an integral of the pressure difference:

$$\text{Surface: } p = p_\infty + \frac{\rho}{2}(U_\infty^2 - V^2), \quad L = \int_0^C (p_{\text{lower}} - p_{\text{upper}}) b \, dx = \int_0^C \frac{\rho}{2} (V_{\text{upper}}^2 - V_{\text{lower}}^2) b \, dx$$

$$\text{Non-dimensionalize: } C_L = \frac{L}{(\rho/2)U_\infty^2 b C} = \int_0^1 [(V/U)_{\text{upp}}^2 - (V/U)_{\text{low}}^2] d\left(\frac{x}{C}\right)$$

Thus the lift coefficient is an integral of the difference in  $(V/U)^2$  on the airfoil. Such a plot is shown below. The area between the curves is approximately

$$\int_0^1 \Delta(V/U)^2 \approx C_L \approx \mathbf{0.21} \quad \text{Ans. (a); } \alpha = \sin^{-1}\left(\frac{0.21}{2\pi}\right) \approx \mathbf{1.9^\circ} \quad \text{Ans. (b)}$$

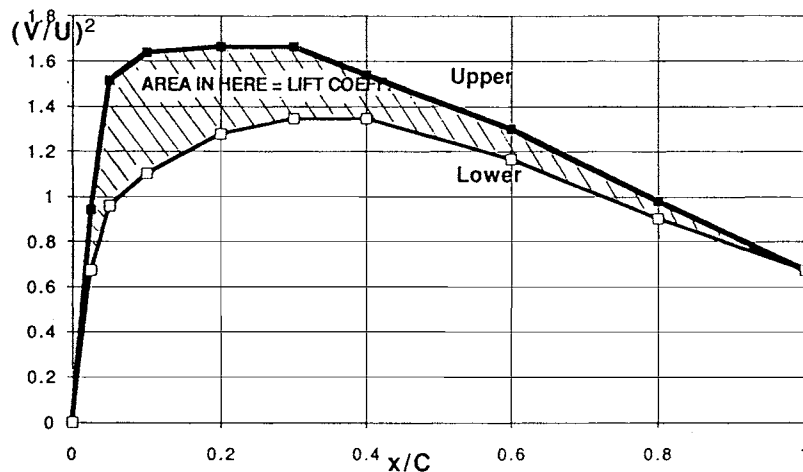


Fig. P8.84

**8.85** A wing of 2 percent camber, 5-in chord, and 30-in span is tested at a certain angle of attack in a wind tunnel with sea-level standard air at 200 ft/s and is found to have lift of 30 lbf and drag of 1.5 lbf. Estimate from wing theory (a) the angle of attack, (b) the minimum drag of the wing and the angle of attack at which it occurs, and (c) the maximum lift-to-drag ratio.

**Solution:** For sea-level air take  $\rho = 0.00238$  slug/ft<sup>3</sup>. Establish the lift coefficient first:

$$C_L = \frac{2L}{\rho V^2 b C} = \frac{2(30 \text{ lbf})}{0.00238(200)^2 (30/12)(5/12)} = 0.605 = \frac{2\pi \sin[\alpha + \tan^{-1}(0.04)]}{1 + 2/(6.0)}$$

Solve for  $\alpha \approx \mathbf{5.1^\circ}$  Ans. (a)

Find the induced drag and thence the minimum drag (when lift = zero):

$$C_D = \frac{C_L}{20} = 0.0303 = C_{D\infty} + \frac{C_L^2}{\pi AR} = C_{D\infty} + \frac{(0.605)^2}{\pi(6.0)}, \quad \text{solve for } C_{D\infty} = 0.0108$$

$$\text{Then } D_{\min} = C_{D\infty} \frac{\rho}{2} V^2 b C = 0.0108 \left( \frac{0.00238}{2} \right) (200)^2 \left( \frac{30}{12} \right) \left( \frac{5}{12} \right) \approx \mathbf{0.54 \text{ lbf}} \quad \text{Ans. (b)}$$

Finally, the maximum L/D ratio occurs when  $C_D = 2C_{D\infty}$ , or:

$$C_L \left( \text{at max } \frac{L}{D} \right) = \sqrt{\pi AR C_{D\infty}} = \sqrt{\pi(6)(0.0108)} = 0.451,$$

$$\text{whence } (L/D)_{\max} = \frac{0.451}{2(0.0108)} \approx \mathbf{21} \quad \text{Ans. (c)}$$

**8.86** An airplane has a mass of 20,000 kg and flies at 175 m/s at 5000-m standard altitude. Its rectangular wing has a 3-m chord and a symmetric airfoil at  $2.5^\circ$  angle of attack. Estimate (a) the wing span; (b) the aspect ratio; and (c) the induced drag.

**Solution:** For air at 5000-m altitude, take  $\rho = 0.736 \text{ kg/m}^3$ . We know W, find b:

$$L = W = 20000(9.81) = C_L \frac{\rho}{2} V^2 b C = \frac{2\pi \sin 2.5^\circ}{1 + 2(3/b)} \left( \frac{0.736}{2} \right) (175)^2 b(3.0)$$

$$\text{Rearrange to } b^2 - 21.2b - 127 = 0, \quad \text{or } b \approx \mathbf{26.1 \text{ m}} \quad \text{Ans. (a)}$$

$$\text{Aspect ratio } AR = b/C = 26.1/3.0 \approx \mathbf{8.7} \quad \text{Ans. (b)}$$

With aspect ratio known, we can solve for lift and induced-drag coefficients:

$$C_L = \frac{2\pi \sin 2.5^\circ}{1 + 2/8.7} = 0.223, \quad C_{Di} = \frac{C_L^2}{\pi AR} = \frac{(0.223)^2}{\pi(8.7)} = 0.00182$$

$$\text{Induced drag} = (0.00182)(0.736/2)(175)^2(26.1)(3) \approx \mathbf{1600 \text{ N}} \quad \text{Ans. (c)}$$

**8.87** A freshwater boat of mass 400 kg is supported by a rectangular hydrofoil of aspect ratio 8, 2% camber, and 12% thickness. If the boat travels at 7 m/s and  $\alpha = 2.5^\circ$ , estimate (a) the chord length; (b) the power required if  $C_{D\infty} = 0.01$ , and (c) the top speed if the boat is refitted with an engine which delivers 20 hp to the water.

**Solution:** For fresh water take  $\rho = 998 \text{ kg/m}^3$ . (a) Use Eq. (8.82) to estimate the chord length:

$$\begin{aligned} \text{Lift} = C_L \frac{\rho}{2} V^2 b C &= \frac{2\pi \sin \left[ \frac{2.5}{57.3} + 2(0.02) \right]}{1 + 2/8} \left( \frac{998 \text{ kg/m}^3}{2} \right) (7 \text{ m/s})^2 (8C)C, \\ &= (400 \text{ kg})(9.81 \text{ m/s}^2) \end{aligned}$$

$$\text{Solve for } C^2 = 0.0478 \text{ m}^2 \text{ or } C \approx \mathbf{0.219 \text{ m}} \text{ Ans. (a)}$$

(b) At 7 m/s, the power required depends upon the drag, with  $C_L = 0.420$  from part (a):

$$C_D = C_{D\infty} + \frac{C_L^2}{\pi(AR)} = 0.01 + \frac{(0.420)^2}{\pi(8)} = 0.0170$$

$$F = C_D \frac{\rho}{2} V^2 b C = (0.0170) \left( \frac{998 \text{ kg/m}^3}{2} \right) (7 \text{ m/s})^2 (8 \times 0.219 \text{ m})(0.219 \text{ m}) = 159 \text{ N}$$

$$\text{Power} = FV = (159 \text{ N})(7 \text{ m/s}) = 1120 \text{ W} = \mathbf{1.5 \text{ hp}} \text{ Ans. (b)}$$

(c) Set up the power equation again with velocity unknown:

$$\text{Power} = FV = \left[ \left( C_{D\infty} + \frac{C_L^2}{\pi(AR)} \right) \left( \frac{\rho}{2} \right) V^2 b C \right] V, \quad C_L = \frac{2(\text{Weight})}{\rho V^2 b C} = \frac{2\pi \sin(\alpha - \alpha_{ZL})}{1 + 2/(AR)}$$

Enter the data:  $C_{D\infty} = 0.01$ ,  $C = 0.219 \text{ m}$ ,  $b = 1.75 \text{ m}$ ,  $AR = 8$ ,  $\text{Weight} = 3924 \text{ N}$ ,  $\text{Power} = 20 \text{ hp} = 14914 \text{ W}$ ,  $\alpha_{ZL} = -2.29^\circ$ ,  $\rho = 998 \text{ kg/m}^3$ . Iterate (or use EES) to find the results:

$$C_L = 0.0526, \quad C_D = 0.0101, \quad \alpha = -1.69^\circ, \quad \mathbf{V_{\max} = 19.8 \text{ m/s} \approx 44 \text{ mi/h}} \text{ Ans. (c)}$$

**8.88** The Boeing 727 airplane has a gross weight of 125000 lbf, a wing area of 1200 ft<sup>2</sup>, and an aspect ratio of 6. It has two turbofan engines and cruises at 532 mi/h at 30000 feet standard altitude. Assume that the airfoil is the NACA 2412 section from Prob. 8.83. If we neglect all drag except the wing, what thrust is required from each engine for these conditions?

**Solution:** At 30000 ft = 9144 m,  $\rho \approx 0.000888 \text{ slug/ft}^3$ . Convert 532 mi/h = 780 ft/s. We have sufficient information to calculate the lift coefficient:

$$C_L = \frac{2W}{\rho V^2 A} = \frac{2(125000)}{8.88\text{E-}4(780)^2(1200)} = 0.385 = \frac{C_{L\infty}}{1 + 2/6}, \text{ hence } C_{L\infty} = 0.514$$



From Prob. 8.83,  $\alpha \approx 3.18^\circ$ ,  $\therefore C_{D\infty} = 0.0100$ , or  $C_D = 0.010 + \frac{(0.385)^2}{\pi(6)} \approx \mathbf{0.0179}$

With drag coefficient estimated, the drag force (or thrust) follows easily:

$$F = C_D \frac{\rho}{2} V^2 A = 0.0179 \left( \frac{8.88E-4}{2} \right) (780)^2 (1200) = 5800 \text{ lbf}$$

Hence required engine thrust =  $F/2 \approx \mathbf{2900 \text{ lbf}}$  each *Ans.*

**8.89** The Beechcraft T-34C airplane has a gross weight of 5500 lbf, a wing area of 60 ft<sup>2</sup>, and cruises at 322 mi/h at 10000 feet standard altitude. It is driven by a propeller which delivers 300 hp to the air. Assume that the airfoil is the NACA 2412 section from Prob. 8.83 and neglect all drag except the wing. What is the appropriate aspect ratio for this wing?

**Solution:** At 10000 ft = 3048 m,  $\rho \approx 0.00176 \text{ slug/ft}^3$ . Convert 322 mi/h = 472 ft/s. From the weight and power we can compute the lift and drag coefficients:

$$C_L = \frac{2W}{\rho V^2 A} = \frac{2(5500)}{0.00176(472)^2(60)} = 0.468 = \frac{C_{L\infty}}{1 + 2/AR}$$

$$\begin{aligned} \text{Power} &= 300 \text{ hp} \times 550 = 165000 \frac{\text{ft}\cdot\text{lbf}}{\text{s}} \\ &= C_D \left( \frac{0.00176}{2} \right) (472)^2 (60) (472), \text{ or } C_D \approx 0.0297 \end{aligned}$$

With  $C_L$  &  $C_D$  known and their values at  $AR = \infty$  from Prob. 8.83, we can compute AR:

$$0.468 = \frac{C_{L\infty}}{1 + 2/AR}; \quad C_D = 0.0297 = C_{D\infty} + \frac{(0.468)^2}{\pi AR}, \text{ with “}\infty\text{” from Prob. 8.83}$$

By iteration, the solution converges to  $\alpha \approx 5.25^\circ$  and  $\mathbf{AR \approx 3.73}$ . *Ans.*

**8.90** NASA is developing a swing-wing airplane called the Bird of Prey [37]. As shown in Fig. P8.90, the wings pivot like a pocketknife blade: forward (a), straight (b), or backward (c). Discuss a possible advantage for each of these wing positions. If you can't think of any, read the article [37] and report to the class.

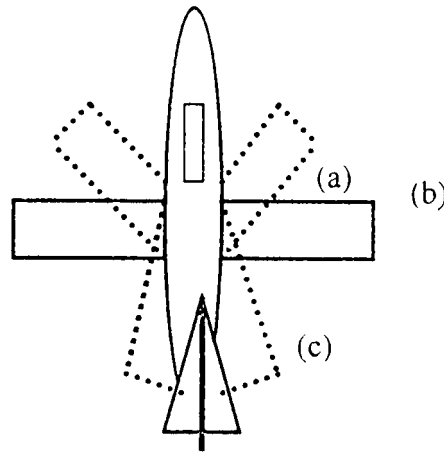


Fig. P8.90

**Solution:** Each configuration has a different advantage: (a) highly maneuverable but unstable, needs computer control; (b) maximum lift at low speeds, best for landing and take-off; (c) maximum speed possible with wings swept back.

**8.91** If  $\phi(r, \theta)$  in axisymmetric flow is defined by Eq. (8.85) and the coordinates are given in Fig. 8.24, determine what partial differential equation is satisfied by  $\phi$ .

**Solution:** The velocities are related to  $\phi$  by Eq. (8.87), and direct substitution gives

$$\frac{\partial}{\partial r}(r^2 v_r \sin \theta) + \frac{\partial}{\partial \theta}(r v_\theta \sin \theta) = 0, \quad \text{with } v_r = \frac{\partial \phi}{\partial r} \quad \text{and} \quad v_\theta = \frac{1}{r} \frac{\partial \phi}{\partial \theta}$$

$$\text{Thus the PDE for } \phi \text{ is: } \sin \theta \frac{\partial}{\partial r} \left( r^2 \frac{\partial \phi}{\partial r} \right) + \frac{\partial}{\partial \theta} \left( \frac{\partial \phi}{\partial \theta} \sin \theta \right) = 0 \quad \text{Ans.}$$

This linear but complicated PDE is *not* Laplace's Equation in axisymmetric coordinates.

**8.92** A point source with volume flow  $Q = 30 \text{ m}^3/\text{s}$  is immersed in a uniform stream of speed  $4 \text{ m/s}$ . A Rankine half-body of revolution results. Compute (a) the distance from the source to the stagnation point; and (b) the two points  $(r, \theta)$  on the body surface where the local velocity equals  $4.5 \text{ m/s}$ . [See Fig. 8.26]

**Solution:** The properties of the Rankine half-body follow from Eqs. (8.89) and (8.94):

$$m = \frac{Q}{4\pi} = \frac{30}{4\pi} = 2.39 \frac{\text{m}^3}{\text{s}}, \quad \text{hence } a = \sqrt{\frac{m}{U}} = \sqrt{\frac{2.39}{4}} \approx 0.77 \text{ m} \quad \text{Ans. (a)}$$

[It's a *big* half-body, to be sure.] Some iterative computation is needed to find the body shape and the velocities along the body surface:

$$\text{Surface, } \psi = -Ua^2: \quad r = a \frac{\sqrt{2(1+\cos\theta)}}{\sin\theta} = a \csc\left(\frac{\theta}{2}\right), \quad \text{with velocity components}$$

$$v_r = U \cos\theta + m/r^2 \quad \text{and} \quad v_\theta = -U \sin\theta$$

A brief tabulation of surface velocities reveals *two* solutions, both for  $\theta < 90^\circ$ :

$\theta$ :	40°	50°	<b>50.6°</b>	60°	70°	80°	<b>88.1°</b>	90°	100°
V, m/s:	4.37	4.49	<b>4.50</b>	4.58	4.62	4.59	<b>4.50</b>	4.47	4.27

As in Fig. 8.26, V rises to a peak of 4.62 m/s (1.155U) at  $70.5^\circ$ , passing through 4.5 m/s at  $(r, \theta) \approx (1.808 \text{ m}, 50.6^\circ)$  and  $(1.111 \text{ m}, 88.1^\circ)$ . *Ans.*

**8.93** The Rankine body of revolution of Fig. 8.26 could simulate the shape of a pitot-static tube (Fig. 6.30). According to inviscid theory, how far downstream from the nose should the static-pressure holes be placed so that the local surface velocity is within  $\pm 0.5\%$  of U? Compare your answer with the recommendation  $x \approx 8D$  in Fig. 6.30.

**Solution:** We search iteratively along the surface until we find  $\mathbf{V} = 1.005U$ :

$$\text{Along } r/a = \csc(\theta/2), \quad v_r = U \cos\theta + \frac{m}{r^2}, \quad v_\theta = -U \sin\theta, \quad V = \sqrt{v_r^2 + v_\theta^2}, \quad m = Ua^2$$

The solution is found at  $\theta \approx 8.15^\circ$ ,  $x \approx 13.93a$ ,  $\Delta x/D = 14.93a/4a \approx 3.73$ . *Ans.*  
[Further downstream, at  $\Delta x = 8D$ , we find that  $V \approx 1.001U$ , or within 0.1%.]

**8.94** Determine whether the Stokes streamlines from Eq. (8.86) are everywhere orthogonal to the Stokes potential lines from Eq. (8.87), as is the case for cartesian and plan polar coordinates.

**Solution:** Compare the ratio of velocity components for lines of constant  $\psi$ :

$$\left. \frac{dr}{r d\theta} \right|_{\text{streamline}} = \frac{v_r}{v_\theta} = \frac{-(1/r^2 \sin\theta)(\partial\psi/\partial\theta)}{(1/r \sin\theta)(\partial\psi/\partial r)} = \frac{\partial\phi/\partial r}{(1/r)(\partial\phi/\partial\theta)}$$

$$\text{or: } \frac{-(1/r)(\partial\psi/\partial\theta)}{(\partial\psi/\partial r)} = -1 \left/ \left[ \frac{-(1/r)(\partial\phi/\partial\theta)}{\partial\phi/\partial r} \right] \right., \quad \text{thus } [\text{slope}]_{\psi \text{ line}} = \frac{-1}{[\text{slope}]_{\phi \text{ line}}}$$

They **are** orthogonal. *Ans.*

**8.95** Show that the axisymmetric potential flow formed by a point source  $+m$  at  $(-a, 0)$ , a point sink  $-m$  at  $(+a, 0)$ , and a stream  $U$  in the  $x$  direction becomes a Rankine body of revolution as in Fig. P8.95. Find analytic expressions for the length  $2L$  and diameter  $2R$  of the body.

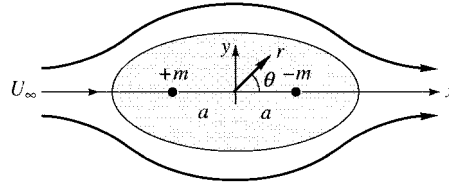


Fig. P8.95

**Solution:** The stream function for this three-part superposition is given below, and the body shape (the *Rankine ovoid*) is given by  $\psi = 0$ .

$$\psi = -\frac{U}{2}r^2 \sin^2 \theta + m(\cos \theta_2 - \cos \theta_1), \quad \text{where "2" and "1" are from the source/sink.}$$

$$\text{Stagnation points at } r = L, \theta = 0, \pi, \quad \text{or} \quad U + \frac{m}{(L+a)^2} - \frac{m}{(L-a)^2} = 0$$

$$\text{Solve for } [(L/a)^2 - 1]^2 = \frac{4m}{Ua^2}(L/a) \quad \text{Ans.}$$

Similarly, the maximum radius  $R$  of the ovoid occurs at  $\psi = 0, \theta = \pm 90^\circ$ :

$$0 = -\frac{U}{2}R^2 + 2m \cos \theta_2, \quad \text{where } \cos \theta_2 = \frac{a}{\sqrt{a^2 + R^2}},$$

$$\text{or: } (R/a)^2 \sqrt{1 + (R/a)^2} = \frac{4m}{Ua^2} \quad \text{Ans.}$$

Some numerical values of length and diameter are as follows:

$m/Ua^2$ :	0.01	0.1	1.0	10.0	100.0
$L/a$ :	1.100	1.313	1.947	3.607	7.458
$R/a$ :	0.198	0.587	1.492	3.372	7.458
$L/R$ :	5.553	2.236	1.305	1.070	1.015

As  $m/Ua^2$  increases, the ovoid approaches a large spherical shape,  $L/R \approx 1.0$ .

**8.96** Suppose that a sphere with a single stagnation hole is to be used as a velocimeter. The pressure at this hole is used to compute the stream velocity  $U$ , but there are errors if the stream is not perfectly aligned with the oncoming stream. Using inviscid incompressible theory, plot the % error in stream velocity as a function of misalignment angle  $\phi$ . At what angle is the error 10%?

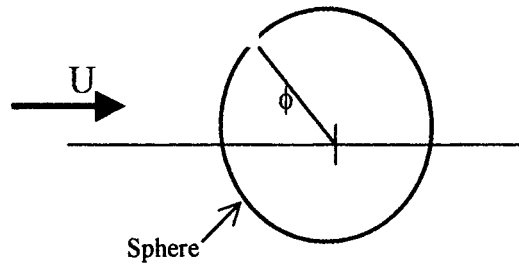


Fig. P8.96

**Solution:** It is assumed that the pressure gage reads the difference between the pressure  $p_s$  at the hole and the ambient pressure  $p_a$ . When perfectly aligned, we have actual stagnation pressure  $p_o$  and may compute

$$p_s = p_o = p_a + \frac{\rho}{2}U^2, \quad \text{or: } U = \sqrt{\frac{2(p_s - p_a)}{\rho}}$$

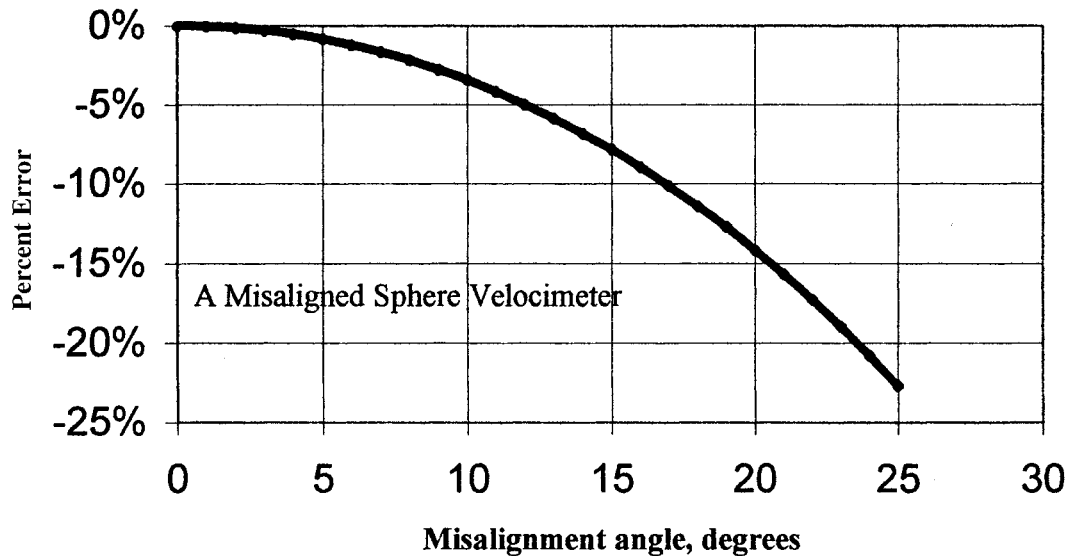
If we are misaligned by an angle  $\phi$ , there is a non-zero velocity  $V$  at the hole, given by Eq. (8.100):  $V = (3/2)U \sin \phi$ . Bernoulli's equation gives

$$p_a + \frac{\rho}{2}U^2 = p_s + \frac{\rho}{2}V^2, \quad \text{or: } U^2 - V^2 = \frac{2(p_s - p_a)}{\rho} = U^2 \left(1 - \frac{9}{4}\sin^2 \phi\right)$$

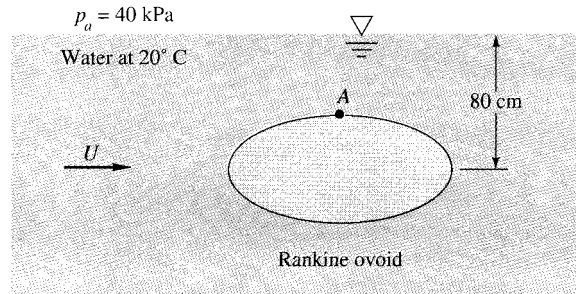
Thus the instrument reads **low** by the amount  $\sqrt{1 - (9/4)\sin^2 \phi}$  *Ans.*

The error is 10%, that is,  $U_{\text{measured}} = 0.9U_{\text{actual}}$ , when  $\phi = 16.9^\circ$ . *Ans.*

A plot of the percent error in velocity is given below as a function of  $\phi$ .



**8.97** The Rankine body or revolution in Fig. P8.97 is 60 cm long and 30 cm in diameter. When it is immersed in the low-pressure water tunnel as shown, cavitation may appear at point A. Compute the stream velocity  $U$ , neglecting surface wave formation, for which cavitation occurs.



**Fig. P8.97**

**Solution:** For water at 20°C, take  $\rho = 998 \text{ kg/m}^3$  and  $p_v = 2337 \text{ Pa}$ . For an ovoid of ratio  $L/R = 60/30 = 2.0$ , we may interpolate in the Table of Prob. 8.95 to find

$$\frac{m}{Ua^2} = 0.1430, \quad \frac{L}{a} = 1.3735, \quad \text{hence } a = \frac{30}{1.3735} = 21.84 \text{ cm}, \quad R = 0.687a = 15.0 \text{ cm},$$

$$m = 0.143Ua^2 = 0.00682U, \quad U_{\max} = U + \frac{2ma}{r_2^3} = U + \frac{2(0.00682U)(0.2184)}{[(.2184)^2 + (.15)^2]^{3/2}} \approx 1.16U$$

Then Bernoulli's equation allows us to compute  $U$  when point A reaches vapor pressure:

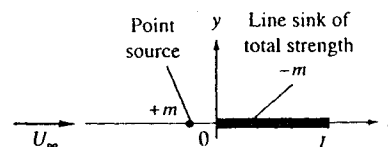
$$p_\infty + \frac{\rho}{2}U^2 + \rho gz_\infty \approx p_A + \frac{\rho}{2}V_A^2 + \rho gz_A$$

$$\text{where } V_A = 1.16U \quad \text{and} \quad p_\infty = p_{\text{atm}} + \rho g(z_{\text{surf}} - z_\infty)$$

$$40000 + 9790(0.8) + \frac{998}{2}U^2 + 0 = 2337 + \frac{998}{2}(1.16U)^2 + 9790(0.15)$$

$$\text{Solve for cavitation speed } \quad U \approx 16 \frac{\text{m}}{\text{s}} \quad \text{Ans.}$$

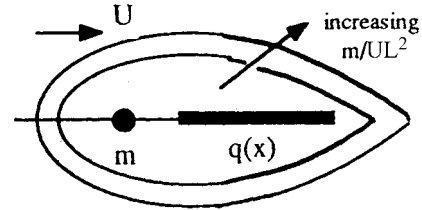
**8.98** We have studied the point source (sink) and the line source (sink) of infinite depth into the paper. Does it make any sense to define a finite-length line sink (source) as in Fig. P8.98? If so, how would you establish the mathematical properties



**Fig. P8.98**

of such a finite line sink? When combined with a uniform stream and a point source of equivalent strength as in Fig. P8.98, should a closed-body shape be formed? Make a guess and sketch some of these possible shapes for various values of the dimensionless parameter  $m/(U_x L^2)$ .

**Solution:** Yes, the “sheet” sink makes good sense and will create a body with a sharper trailing edge. If  $q(x)$  is the local sink strength, then  $m = \int q(x) dx$ , and the body shape is a teardrop which becomes fatter with increasing  $m/UL^2$ .



**8.99** Consider air flowing past a hemisphere resting on a flat surface, as in Fig. P8.99. If the internal pressure is  $p_i$ , find an expression for the pressure force on the hemisphere. By analogy with Prob. 8.49 at what point A on the hemisphere should a hole be cut so that the pressure force will be zero according to inviscid theory?

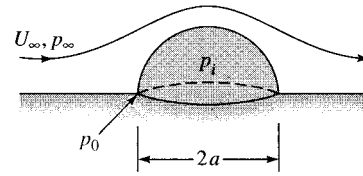


Fig. P8.99

**Solution:** Recall from Eq. (8.100) that the velocity along the sphere surface is

$$V_s = \frac{3}{2} U_\infty \sin \theta \quad \text{and} \quad F_{\text{up}} = \int_0^{\pi/2} (p_i - p_s) 2\pi a \sin \theta a d\theta \cos \theta, \quad \text{where}$$

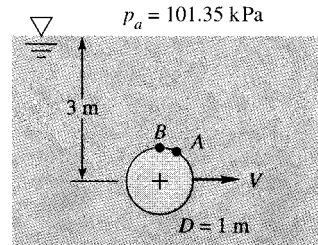
$$p_s(\text{Bernoulli}) = p_o - \frac{\rho}{2} \left( \frac{3}{2} U_\infty \sin \theta \right)^2, \quad \text{work out } F = \pi a^2 (p_i - p_o) + \frac{9\pi}{16} \rho U_\infty^2 a^2$$

This force is zero if we put a hole at point A ( $\theta = \theta_A$ ) such that

$$p_A = p_o - \frac{9}{16} \rho U_\infty^2 = p_o - \frac{\rho}{2} V_A^2, \quad \text{or} \quad V_A = \sqrt{\frac{9}{8}} U_\infty = 1.061 U_\infty \stackrel{?}{=} \frac{3}{2} U_\infty \sin \theta_A$$

Solve for  $\theta_A \approx 45^\circ$  or  $135^\circ$  Ans.

**8.100** A 1-m-diameter sphere is being towed at speed  $V$  in fresh water at  $20^\circ\text{C}$  as shown in Fig. P8.100. Assuming inviscid theory with an undistorted free surface, estimate the speed  $V$  in m/s at which cavitation will first appear on the sphere surface. Where will cavitation appear? For this condition, what will be the pressure at point A on the sphere which is  $45^\circ$  up from the direction of travel?



**Fig. P8.100**

**Solution:** For water at  $20^\circ\text{C}$ , take  $\rho = 998 \text{ kg/m}^3$  and  $p_v = 2337 \text{ Pa}$ . Cavitation will occur at the lowest-pressure point, which is point **B** on the *top* of the cylinder, at  $\theta = 90^\circ$ :

$$p_\infty + \frac{\rho}{2}U_\infty^2 + \rho g z_\infty = p_B + \frac{\rho}{2}V_B^2 + \rho g z_B, \quad \text{where } p_\infty = p_{\text{atm}} + \rho g(z_{\text{surface}} - z_\infty)$$

$$\text{Thus } [101350 + 9790(3)] + \frac{998}{2}U_\infty^2 + 0 = 2337 + \frac{998}{2}(1.5U_\infty)^2 + 9790(0.5)$$

$$\text{Solve for } U_\infty \approx \mathbf{14.1 \frac{m}{s}} \quad \text{Ans. to cause cavitation at point B } (\theta = 90^\circ)$$

With the stream velocity known, we may now solve for the pressure at point A ( $\theta = 45^\circ$ ):

$$p_A + \frac{998}{2} \left[ \frac{3}{2}(14.1) \sin 45^\circ \right]^2 + 9790(0.5 \sin 45^\circ) = 101350 + 9790(3) + \frac{998}{2}(14.1)^2$$

$$\text{Solve for } \mathbf{p_A \approx 115000 \text{ Pa}} \quad \text{Ans.}$$

**8.101** Consider a steel sphere ( $SG = 7.85$ ) of diameter 2 cm, dropped from rest in water at  $20^\circ\text{C}$ . Assume a constant drag coefficient  $C_D = 0.47$ . Accounting for the sphere's hydrodynamic mass, estimate (a) its terminal velocity; and (b) the time to reach 99% of terminal velocity. Compare these to the results when hydrodynamic mass is neglected,  $V_{\text{terminal}} \approx 1.95 \text{ m/s}$  and  $t_{99\%} \approx 0.605 \text{ s}$ , and discuss.

**Solution:** For water take  $\rho = 998 \text{ kg/m}^3$ . Add hydrodynamic mass to the differential equation:

$$(m + m_h) \frac{dV}{dt} = W_{\text{net}} - C_D \frac{\rho}{2} V^2 A, \quad A = \frac{\pi}{4} D^2 \quad \text{and} \quad W_{\text{net}} = (\rho_{\text{steel}} - \rho_{\text{water}}) g \frac{\pi}{6} D^3$$

$$\text{Separate the variables and integrate: } V = \sqrt{\frac{2W_{\text{net}}}{C_D \rho A}} \tanh \left( t \sqrt{\frac{W_{\text{net}} C_D \rho A}{2(m + m_h)^2}} \right)$$



(a) The terminal velocity is the coefficient of the  $\tanh$  function in the previous equation:

$$V_f = \sqrt{\frac{2W_{net}}{C_D \rho A}} = \sqrt{\frac{2(7834 - 998)(9.81)(\pi/6)(0.02)^3}{(0.47)(998)(\pi/4)(0.02)^2}}$$

$$= \mathbf{1.95 \frac{m}{s}}$$
 (same as when  $m_h = 0$ ) *Ans. (a)*

(b) Noting that  $\tanh(2.647) = 0.99$ , we find the time to approach 99% of  $V_f$  to be

$$t \sqrt{\frac{W_{net} C_D \rho A}{2(m + m_h)^2}} = 2.647$$

$$= t \sqrt{\frac{(7834 - 998)(9.81)(\pi/6)(0.02)^3 (0.47)(998)(\pi/4)(0.02)^2}{2[(7834 + 998/2)(\pi/6)(0.02)^3]^2}} = 4.122t$$

Solve for  $t = 2.647/4.122 = \mathbf{0.642 \text{ s}}$  (6% more than when  $m_h = 0$ ) *Ans. (b)*

**8.102** A golf ball weighs 0.102 lbf and has a diameter of 1.7 in. A professional golfer strikes the ball at an initial velocity of 250 ft/s, an upward angle of  $20^\circ$ , and a backspin (front of the ball rotating upward). Assume that the lift coefficient on the ball (based on frontal area) follows Fig. P7.108. If the ground is level and drag is neglected, make a simple analysis to predict the impact point (a) without spin and (b) with backspin of 7500 r/min.

**Solution:** For sea-level air, take  $\rho = 0.00238 \text{ slug/ft}^3$ . (a) If we neglect drag and spin, we just use classical particle physics to predict the distance travelled:

$$V = V_{oz} - gt = 0 \quad \text{when } t = \frac{V_o \sin \theta_o}{g}, \quad x = V_{ox}(2t) = \frac{V_o^2}{g} 2 \sin \theta_o \cos \theta_o$$

$$\text{Substitute } \Delta x_{\text{impact}} = \frac{(250)^2}{32.2} 2 \sin 20^\circ \cos 20^\circ \approx \mathbf{1250 \text{ ft}} \quad \text{Ans. (a)}$$

For part (b) we have to estimate the lift of the spinning ball, using Fig. P7.108:

$$\omega = 7500 \left( \frac{2\pi}{60} \right) = 785 \frac{\text{rad}}{\text{s}}, \quad \frac{\omega R}{U} = \frac{785(1.7/24)}{250} \approx 0.22: \text{ Read } C_L \approx 0.02$$

Estimate average lift  $L \approx C_L (\rho/2) V^2 \pi R^2$

$$= (0.02) \left( \frac{0.00238}{2} \right) (250)^2 \pi \left( \frac{1.7}{24} \right)^2 \approx 0.023 \text{ lbf}$$

Write the equations of motion in the z and x directions and assume average values:

$$m\ddot{x} = -L \sin \theta, \text{ with } \theta_{\text{avg}} \approx 10^\circ, \quad \ddot{x}_{\text{avg}} \approx -\frac{0.023}{0.102/32.2} \sin 10^\circ \approx -1.3 \frac{\text{ft}}{\text{s}^2}$$

$$\text{Then } x \approx V_{\text{ox}} t - \frac{1}{2} \ddot{x}_{\text{avg}} t^2, \quad \text{where } t = 2 \times (\text{time to reach the peak})$$

$$m\ddot{z} = L \cos \theta - W, \quad \text{or } \ddot{z}_{\text{avg}} \approx \frac{0.023}{0.102/32.2} \cos 10^\circ - 32.2 \approx -25 \frac{\text{ft}}{\text{s}^2}$$

Using these admittedly crude estimates, the travel distance to impact is estimated:

$$t_{\text{peak}} = \frac{V_{\text{oz}}}{a_z} = \frac{250 \sin 20^\circ}{25} \approx 3.4 \text{ s}, \quad t_{\text{impact}} = 2t_{\text{peak}} \approx 6.8 \text{ s},$$

$$\Delta x_{\text{impact}} = V_{\text{ox}} t - \frac{1}{2} a_x t^2 = 250 \cos 20^\circ (6.8) - \frac{1.3}{2} (6.8)^2 \approx \mathbf{1570 \text{ ft}} \quad \text{Ans. (b)}$$

These are 400-yard to 500-yard drives, on the fly! It would be nice, at least when teeing off, to have zero viscous drag on the golfball.

**8.103** Modify Prob. 8.102 as follows. Golf balls are dimpled, not smooth, and have higher lift and lower drag ( $C_L \approx 0.2$  and  $C_D \approx 0.3$  for typical backspin). Using these values, make a computer analysis of the ball trajectory for the initial conditions of Prob. 8.102. If time permits, investigate the effect of initial angle for the range  $10^\circ < \theta_0 < 50^\circ$ .

**Solution:** Again take  $\rho = 0.00238 \text{ slug/ft}^3$  for sea-level air. The equations of motion are

$$m\ddot{x} = -D \cos \theta - L \sin \theta, \quad \text{where } D = C_D \frac{\rho}{2} V^2 \pi R^2 = 0.3 \left( \frac{0.00238}{2} \right) (\dot{x}^2 + \dot{z}^2) \pi \left( \frac{1.7}{24} \right)^2$$

$$m\ddot{z} = -W - D \sin \theta + L \cos \theta, \quad \text{where } L = \mathbf{0.2} \left( \frac{0.00238}{2} \right) (\dot{x}^2 + \dot{z}^2) \pi (1.7/24)^2,$$

$$W = 0.102 \text{ lbf} \quad x_0 = 0, \quad \dot{x}_0 = 250 \cos 20^\circ \frac{\text{ft}}{\text{s}}; \quad z_0 = 0, \quad \dot{z}_0 = 250 \sin 20^\circ \frac{\text{ft}}{\text{s}}$$

These may be solved numerically, by Runge-Kutta or whatever, until impact. The complete trajectory is shown in the graph on the next page for the specific problem stated here. The impact point is at  $t = 7.7 \text{ s}$ ,  $\mathbf{x \approx 723 \text{ ft} = 241 \text{ yards}}$ . *Ans.* (A mediocre drive)

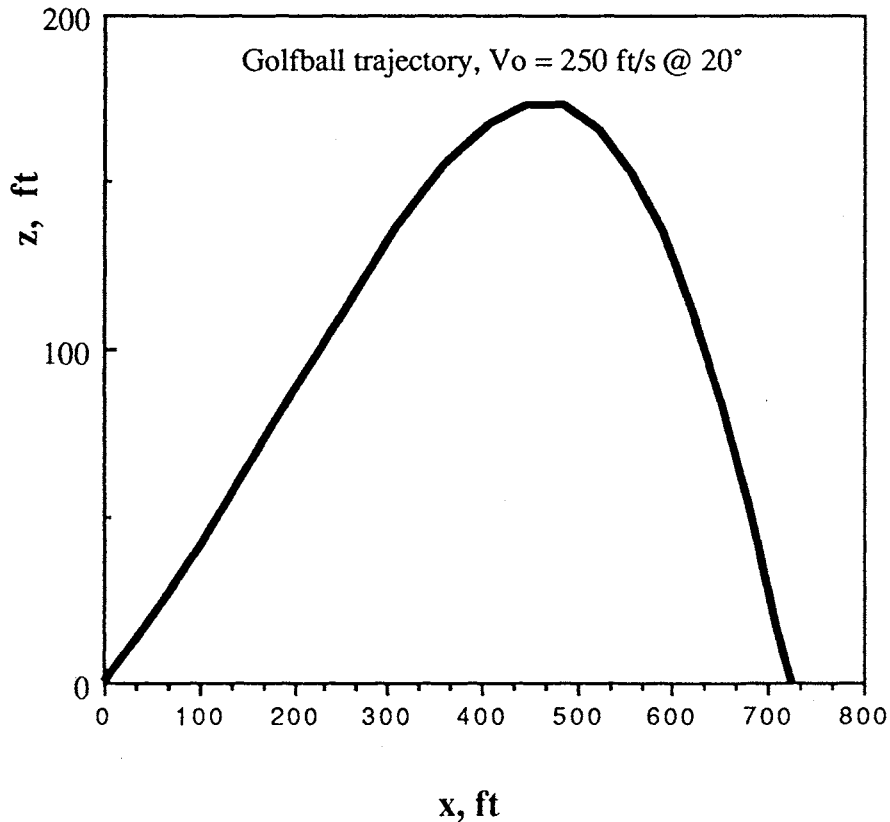


Fig. P8.103

Other impacts: for  $\theta_0 = (10^\circ, 20^\circ, 30^\circ, 40^\circ, 50^\circ)$ ,  $\Delta x = (705, 723 \text{ ft}, 684, 598, 469 \text{ ft})$ .

**8.104** Consider a cylinder of radius  $a$  moving at speed  $U_\infty$  through a still fluid, as in Fig. P8.104. Plot the streamlines relative to the cylinder by modifying Eq. (8.32) to give the relative flow with  $K = 0$ . Integrate to find the total relative kinetic energy, and verify the hydrodynamic mass of a cylinder from Eq. (8.104).

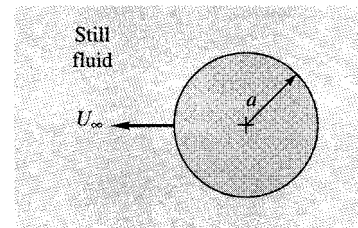


Fig. P8.104

**Solution:** For this two-dimensional polar-coordinate system, a differential **mass** is:

$$dm = \rho b r dr d\theta, \quad \text{where } b = \text{width into the paper}$$

$$\text{Subtract off the stream } U \text{ to get } v_r|_{\text{rel}} = -U \cos \theta (a^2/r^2), \quad v_\theta|_{\text{rel}} = -U \sin \theta (a^2/r^2)$$

That is, the velocities “relative” to the cylinder are, in fact, the velocities induced by the doublet. Now introduce the element kinetic energy into Eq. (8.102) and integrate:

$$\text{KE} = \int_{\text{fluid}} \frac{1}{2} dm V_{\text{rel}}^2 = \int_0^{2\pi} \int_a^\infty \frac{1}{2} (\rho b r dr d\theta) [\{U \cos \theta a^2/r^2\}^2 + \{U \sin \theta a^2/r^2\}^2] = \frac{\pi}{2} \rho U a^2 b$$

Then, by definition,  $m_{\text{hydro}} = \frac{\text{KE}}{U^2/2} = \pi \rho a^2 b = \text{cylinder displaced mass}$  Ans.

**8.105** In Table 7.2 the drag coefficient of a 4:1 elliptical cylinder in laminar-boundary-layer flow is 0.35. According to Patton [17], the hydrodynamic mass of this cylinder is  $\pi \rho h b/4$ , where  $b$  is width into the paper and  $h$  is the maximum thickness. Use these results to derive a formula from the time history  $U(t)$  of the cylinder if it is accelerated from rest in a still fluid by the sudden application of a constant force  $F$ .

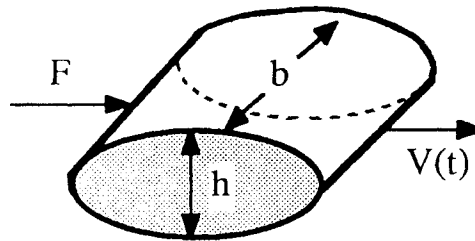


Fig. P8.105

**Solution:** The equation of motion is

$$\sum F_x = (m + m_{\text{hydro}}) \frac{dU}{dt} = F - \text{Drag} = F - C_D \frac{\rho}{2} U^2 b h, \quad \text{separate and integrate:}$$

$$\int_0^U \frac{dU}{F - \zeta U^2} = \int_0^t \frac{dt}{m + m_h}, \quad \text{or: } U = \sqrt{\frac{F}{\zeta}} \tanh \left[ \frac{t \sqrt{F \zeta}}{m + m_h} \right], \quad \zeta = \frac{\rho}{2} C_D b h \quad \text{Ans.}$$

For numerical work, we would use  $m_h = \pi \rho h b/4$ ,  $C_D \approx 0.35$  from Table 7.2.

**8.106** Laplace’s equation in polar coordinates, Eq. (8.11), is complicated by the variable radius  $r$ . Consider the finite-difference mesh in Fig. P8.106, with nodes  $(i, j)$  at equally spaced  $\Delta \theta$  and  $\Delta r$ . Derive a finite-difference model for Eq. (8.11) similar to our cartesian expression in Eq. (8.109).

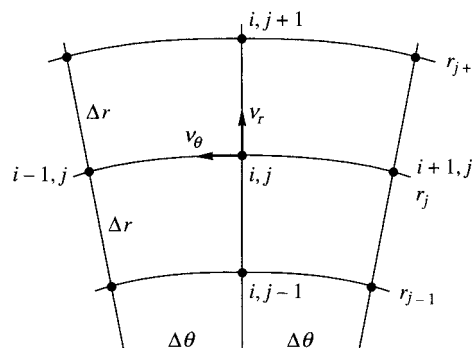


Fig. P8.106

**Solution:** We are asked to model

$$\frac{1}{r} \frac{\partial}{\partial r} \left( r \frac{\partial \psi}{\partial r} \right) + \frac{1}{r^2} \frac{\partial^2 \psi}{\partial \theta^2} = 0$$

There are two possibilities, depending upon whether you split up the first term. I suggest

$$\frac{1}{r_{ij} \Delta r} \left[ \left( r_{ij} + \frac{\Delta r}{2} \right) \left( \frac{\psi_{i,j+1} - \psi_{i,j}}{\Delta r} \right) - \left( r_{ij} - \frac{\Delta r}{2} \right) \left( \frac{\psi_{i,j} - \psi_{i,j-1}}{\Delta r} \right) \right] + \frac{\psi_{i+1,j} - 2\psi_{i,j} + \psi_{i-1,j}}{r_{ij}^2 (\Delta \theta)^2} \approx 0$$

$$\text{Clean up: } (2 + 2\zeta)\psi_{i,j} \approx \psi_{i+1,j} + \psi_{i-1,j} + \zeta(1 + \eta)\psi_{i,j+1} + \zeta(1 - \eta)\psi_{i,j-1} \quad \text{Ans.}$$

$$\text{where } \zeta = (r_{ij} \Delta \theta / \Delta r)^2 \quad \text{and} \quad \eta = \Delta r / (2r_{ij})$$

**8.107** Set up the numerical problem of Fig. 8.30 for an expansion angle of  $30^\circ$ . A new grid system and non-square mesh may be needed. Give the proper nodal equation and boundary conditions. If possible, program this  $30^\circ$  expansion and solve on a digital computer.

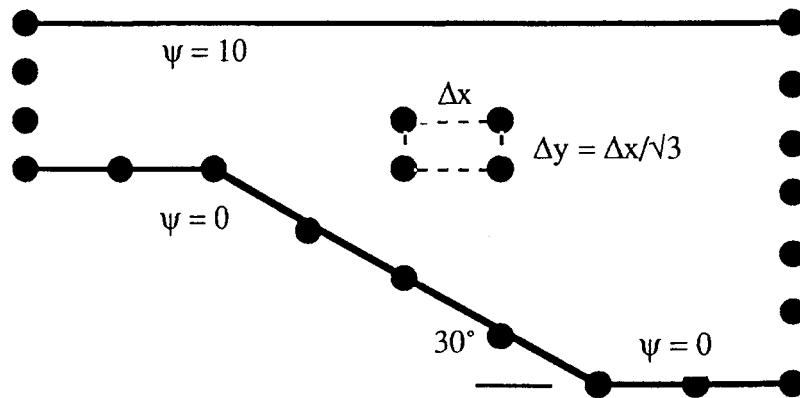


Fig. P8.107

**Solution:** Assuming the *same* 2:1 expansion, from  $U(\text{in}) = 10$  m/s to  $U(\text{out}) = 5$  m/s, we need a non-square mesh to make nodes fall along the slanted line at a  $30^\circ$  slope. The mesh size, as shown, should be  $\Delta y = \Delta x / \sqrt{3}$ . The scale-ratio  $\beta$  from Equation (8.108) equals  $(\Delta x / \Delta y)^2 = 3.0$ , and the model for each node is

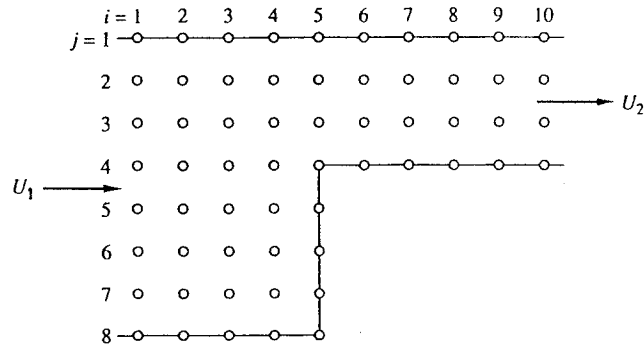
$$2(1 + \beta)\psi_{i,j} = \psi_{i-1,j} + \psi_{i+1,j} + \beta(\psi_{i,j-1} + \psi_{i,j+1}), \quad \text{where } \beta = 3.0 \quad \text{Ans.}$$

The stream function would retain the same boundary values as in Fig. 8.30:  $\psi = 0$  along the lower wall,  $\psi = 10$  along the upper wall, and linear variation, between 0 and 10, along the inlet and exit planes. [See Fig. 8.31 also for boundary values.]

If we keep the same **vertical** nodal spacing in Fig. 8.30,  $\Delta y = 20$  cm, then we need a horizontal spacing  $\Delta x = 34.64$  cm, and the total length of the duct—from  $i = 1$  to  $i = 16$ —will be 519.6 cm, whereas in Fig. 8.30 this total length is only 300 cm.

The numerical results will not be given here.

**8.108** Consider two-dimensional potential flow into a step contraction as in Fig. P8.108. The inlet velocity  $U_1 = 7$  m/s, and the outlet velocity  $U_2$  is uniform. The nodes  $(i, j)$  are labelled in the figure. Set up the complete finite-difference algebraic relation for all nodes. Solve, if possible, on a digital computer and plot the streamlines.



**Fig. P8.108**

**Solution:** By continuity,  $U_2 = U_1(7/3) = 16.33$  m/s. For a square mesh, the standard Laplace model, Eq. (8.109), holds. For simplicity, assume unit mesh widths  $\Delta x = \Delta y = 1$ .

$$\text{Solve } \psi_{i,j} = \frac{1}{4}(\psi_{i,j+1} + \psi_{i,j-1} + \psi_{i+1,j} + \psi_{i-1,j})$$

with  $\psi = 0$  on the lower wall and  $\psi = 49$  on the upper wall.

The writer's numerical solution is tabulated below.

$i =$	1	2	3	4	5	6	7	8	9	10
$j=1, \psi =$	49.00	49.00	49.00	49.00	49.00	49.00	49.00	49.00	49.00	49.00
$j=2$	42.00	40.47	38.73	36.66	34.54	33.46	32.98	32.79	32.79	26.67
$j=3$	35.00	32.17	28.79	24.38	19.06	17.30	16.69	16.46	16.38	16.33
$j=4$	28.00	24.40	19.89	13.00	0.00	0.00	0.00	0.00	0.00	0.00
$j=5$	21.00	17.53	13.37	7.73	0.00					
$j=6$	14.00	11.36	8.32	4.55	0.00					
$j=7$	7.00	5.59	4.02	2.14	0.00					
$j=8$	0.00	0.00	0.00	0.00	0.00					

**8.109** Consider inviscid potential flow through a two-dimensional 90° bend with a contraction, as in Fig. P8.109. Assume uniform flow at the entrance and exit. Make a finite-difference computer model analysis for small grid size (at least 150 nodes), determine the dimensionless pressure distribution along the walls, and sketch the streamlines. [You may use either square or rectangular grids.]

**Solution:** This problem is “digital computer enrichment” and will not be presented here.

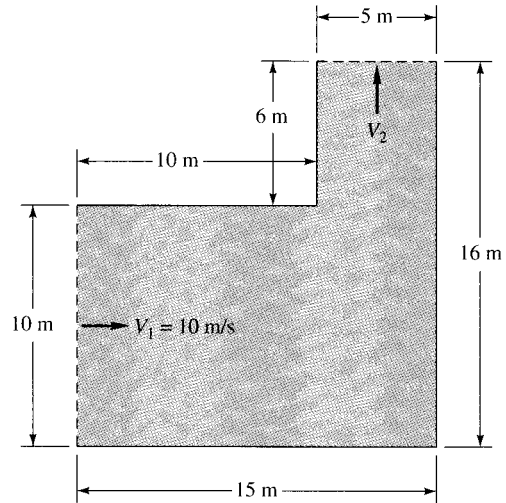


Fig. P8.109

**8.110** For fully developed laminar incompressible flow through a straight noncircular duct, as in Sec. 6.8, the Navier-Stokes Equation (4.38) reduce to

$$\frac{\partial^2 u}{\partial y^2} + \frac{\partial^2 u}{\partial z^2} = \frac{1}{\mu} \frac{dp}{dx} = \text{const} < 0$$

where  $(y, z)$  is the plane of the duct cross section and  $x$  is along the duct axis. Gravity is neglected. Using a nonsquare rectangular grid  $(\Delta x, \Delta y)$ , develop a finite-difference model for this equation, and indicate how it may be applied to solve for flow in a rectangular duct of side lengths  $a$  and  $b$ .

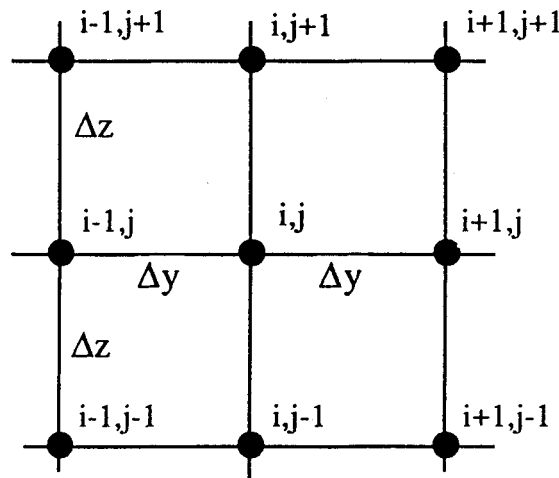


Fig. P8.110





The solution is doubly symmetric because of the rectangular shape. [This mesh is too **coarse**, it only has 27 interior points.] After these dimensionless velocities are computed, the volume flow rate is computed by integration:

$$Q = \int_0^b \int_0^{2b} u \, dy \, dz = \frac{b^4}{\mu} \left( -\frac{dp}{dx} \right) \int_0^1 \int_0^2 V \frac{dy}{b} \frac{dz}{b} = \text{constant} \frac{b^4}{\mu} \left( -\frac{dp}{dx} \right)$$

The double integral was evaluated numerically by summing over all the mesh squares. Two mesh sizes were investigated by the writer, with good results as follows:

$$\begin{aligned} \Delta y/b = 0.2: \quad Q/(b^4/\mu)(-dp/dx) &= \text{“constant”} \approx 0.1063 (7\% \text{ off}) \quad (27 \text{ grid nodes}) \\ &= \mathbf{0.1} \quad \quad \quad \text{“constant”} \approx \mathbf{0.1123} (2\% \text{ off}) \quad (171 \text{ nodes}) \quad \text{Ans.} \end{aligned}$$

The accuracy is good, and the numerical model is very simple to program.

**8.112** In his CFD textbook, Patankar [Ref. 5] replaces the left-hand side of Eq. (8.119b) and (8.119c), respectively, with the following two expressions:

$$\begin{aligned} \text{Replace } u \frac{\partial u}{\partial x} + v \frac{\partial u}{\partial y} &\text{ by } \frac{\partial}{\partial x}(u^2) + \frac{\partial}{\partial y}(vu); \\ \text{Replace } u \frac{\partial v}{\partial x} + v \frac{\partial v}{\partial y} &\text{ by } \frac{\partial}{\partial x}(uv) + \frac{\partial}{\partial y}(v^2) \end{aligned}$$

Are these equivalent expressions, or are they merely simplified approximations? Either way, why might these forms be better for finite-difference purposes?

**Solution:** These expressions are indeed *equivalent* because of the 2-D incompressible continuity equation. In the first example,

$$\frac{\partial}{\partial x}(u^2) + \frac{\partial}{\partial y}(uv) \equiv 2u \frac{\partial u}{\partial x} + u \frac{\partial v}{\partial y} + v \frac{\partial u}{\partial y} = \left[ u \frac{\partial u}{\partial x} + v \frac{\partial v}{\partial y} \right] + u \left( \frac{\partial u}{\partial x} + \frac{\partial v}{\partial y} \right)$$

and similarly for the second example. They are more convenient numerically because, being non-linear terms, they are easier to model as *the difference in products* rather than the *product of differences*.

**8.113** Repeat Example 8.7 using the *implicit* method of Eq. (8.118). Take  $\Delta t = 0.2$  s and  $\Delta y = 0.01$  m, which ensures that an explicit model would *diverge*. Compare your accuracy with Example 8.7.

**Solution:** Recall that SAE 30 oil ( $\nu = 3.25\text{E-}4 \text{ m}^2/\text{s}$ ) was at rest at ( $t = 0$ ) when the wall suddenly began moving at  $U = 1 \text{ m/s}$ . Find the oil velocity at  $(y, t) = (3 \text{ cm}, 1 \text{ s})$ . This time  $\sigma = (3.25\text{E-}4)(0.2)/(0.01)^2 = \mathbf{0.65} > 0.5$ , therefore an implicit method is required. We set up a grid with 11 nodes, going out to  $y = 0.1 \text{ m}$  ( $N = 11$ ), and use Eq. (8.118) to sweep all nodes for each time step. Stop at  $t = 1 \text{ s}$  ( $j = 6$ ):

$$u_n^{j+1} \approx \frac{u_n^j + 0.65(u_{n-1}^{j+1} + u_{n+1}^{j+1})}{1 + 2(0.65)}$$

The results are shown in the table below.

j	Time	u1	u2	u3	u4	U5	u6	u7	u8	u9	u10	u11
1	0.0	1.000	0.000	0.000	0.000	0.000	0.000	0.000	0.000	0.000	0.000	0.000
2	0.2	1.000	0.310	0.096	0.030	0.009	0.003	0.001	0.000	0.000	0.000	0.000
3	0.4	1.000	0.473	0.197	0.077	0.029	0.010	0.004	0.001	0.000	0.000	0.000
4	0.6	1.000	0.568	0.283	0.129	0.055	0.023	0.009	0.003	0.001	0.000	0.000
5	0.8	1.000	0.629	0.351	0.180	0.086	0.039	0.017	0.007	0.003	0.001	0.000
6	1.0	1.000	0.671	0.406	<b>0.226</b>	0.117	0.058	0.027	0.012	0.005	0.002	0.000

This time the computed value of  $u_4$  ( $y = 0.03 \text{ m}$ ) at  $j = 6$  ( $t = 1 \text{ s}$ ) is **0.226**, or about **6% lower** than the exact value of  $0.241$ . This accuracy is comparable to the explicit method of Example 8.7 and uses twice the time step.

**\*8.114** The following problem is not solved in this Manual. It requires Boundary-Element-Code software. If your institution has such software (see, e.g., the computer codes in Ref. 7), this advanced exercise is quite instructive about potential flow about airfoils.

If your institution has an online potential-flow boundary-element computer code, consider flow past a symmetric airfoil, as in Fig. P8.114. The basic shape of an NACA symmetric airfoil is defined by the function [12]

$$\frac{2y}{t_{\max}} \approx 1.4845\zeta^{1/2} - 0.63\zeta - 1.758\zeta^2 + 1.4215\zeta^3 - 0.5075\zeta^4$$

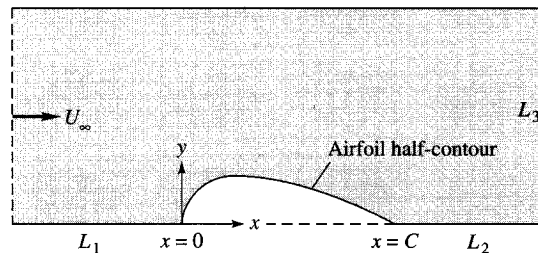


Fig. P8.114

where  $\zeta = x/C$  and the maximum thickness  $t_{\max}$  occurs at  $\zeta = 0.3$ . Use this shape as part of the lower boundary for zero angle of attack. Let the thickness be fairly large, say,  $t_{\max} = 0.12, 0.15,$  or  $0.18$ . Choose a generous number of nodes ( $\geq 60$ ), and calculate and plot the velocity distribution  $V/U_\infty$  along the airfoil surface. Compare with the theoretical results in Ref. 12 for NACA 0012, 0015, or 0018 airfoils. If time permits, investigate the effect of the boundary lengths  $L_1, L_2,$  and  $L_3$ , which can initially be set equal to the chord length  $C$ .

**8.115** Use the explicit method of Eq. (8.115) to solve Problem 4.85 *numerically* for SAE 30 oil ( $\nu = 3.25\text{E-}4 \text{ m}^2/\text{s}$ ) with  $U_o = 1 \text{ m/s}$  and  $\omega = M \text{ rad/s}$ , where  $M$  is the number of letters in your surname. (The author will solve it for  $M = 5$ .) When steady oscillation is reached, plot the oil velocity versus time at  $y = 2 \text{ cm}$ .

**Solution:** Recall that Prob. 4.85 specified an oscillating wall,  $u_{\text{wall}} = U_o \sin(\omega t)$ . One would have to experiment to find that the “edge” of shear layer, that is, where the wall no longer influences the ambient still fluid, is about  $y \approx 7 \text{ cm}$ . For reasonable accuracy, we could choose  $\Delta y = 0.5 \text{ cm}$ , that is,  $0.005 \text{ m}$ , so that  $N = 15$  is the outer “edge.” For explicit calculation, we require

$$\sigma = \nu \Delta t / \Delta y^2 = (3.25\text{E-}4) \Delta t / (0.005)^2 < 0.5, \quad \text{or} \quad \Delta t < 0.038 \text{ s.}$$

We choose  $\Delta t = 0.0333 \text{ s}$ ,  $\sigma = \mathbf{0.433}$ , with 1 cycle covering about 37 time steps. Use Eq. (8.115):

$$u_n^{j+1} \approx 0.433(u_{n-1}^j + u_{n+1}^j) + 0.133u_n^j \quad \text{for } 2 \leq n \leq 14 \quad \text{and} \quad u_1 = 1.0 \sin(5t), \quad u_{15} = 0$$

Apply this algorithm to all the internal nodes ( $2 < n < 14$ ) for many (200) time steps, up to about  $t = 6 \text{ sec}$ . The results for  $y = 2 \text{ cm}$ ,  $n = 5$ , are shown in the plot below. The amplitude has dropped to  $0.18 \text{ m/s}$  with a phase lag of  $20^\circ$  [Ref. 15 of Chap. 8, p. 139].

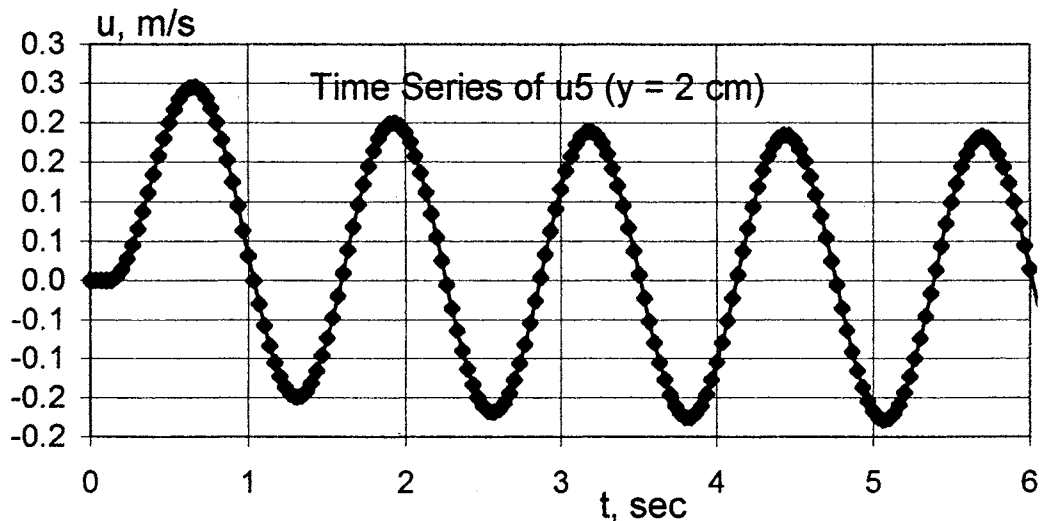
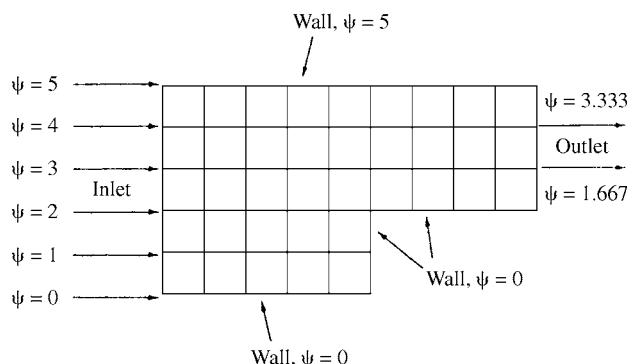


Fig. P8.115

### COMPREHENSIVE PROBLEMS

**C8.1** Did you know you can solve iterative CFD problems on an Excel spreadsheet? Successive relaxation of Laplace's equation is easy, since each nodal value is the average of its 4 neighbors. Calculate irrotational potential flow through a contraction as shown in the figure. To avoid "circular reference," set the Tools/Options/Calculate menu to "iteration." For full credit, attach a printout of your solution with  $\psi$  at each node.



**Fig. C8.1**

**Solution:** Do exactly what the figure shows: Set bottom nodes at  $\psi = 0$ , top nodes at  $\psi = 5$ , left nodes at  $\psi = 0, 1, 2, 3, 4, 5$  and right nodes at  $\psi = 0, 1.667, 3.333, 5$ . Iterate with Eq. (8.115) for at least 100 iterations. Any initial guesses will do—the author chose 2.0 at all interior nodes. The final converged nodal values of stream function are shown in the table below.

i, j	1	2	3	4	5	6	7	8	9	10
1	5.000	5.000	5.000	5.000	5.000	5.000	5.000	5.000	5.000	5.000
2	4.000	3.948	3.880	3.780	3.639	3.478	3.394	3.357	3.342	3.333
3	3.000	2.911	2.792	2.602	2.298	1.879	1.742	1.694	1.675	1.667
4	2.000	1.906	1.773	1.539	1.070	0.000	0.000	0.000	0.000	0.000
5	1.000	0.941	0.856	0.710	0.445	0.000				
6	0.000	0.000	0.000	0.000	0.000	0.000				

**C8.2** Use an *explicit* method, similar to but not identical to Eq. (8.115), to solve the case of SAE 30 oil starting from rest near a fixed wall. Far from the wall, the oil accelerates linearly, that is,  $u_\infty = u_N = at$ , where  $a = 9 \text{ m/s}^2$ . At  $t = 1 \text{ s}$ , determine (a) the oil velocity at  $y = 1 \text{ cm}$ ; and (b) the instantaneous boundary-layer thickness (where  $u \approx 0.99u_\infty$ ).

*Hint:* There is a non-zero pressure gradient in the outer (shear-free) stream,  $n = N$ , which must be included in Eq. (8.114).

**Solution:** To account for the stream acceleration as  $\partial^2 u / \partial t^2 = 0$ , we add a term:

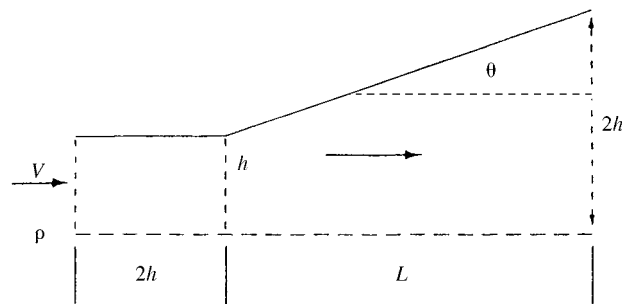
$$\rho \frac{\partial u}{\partial t} = \rho a + \mu \frac{\partial^2 u}{\partial y^2}, \quad \text{which changes the model of Eq. (8.115) to}$$

$$u_n^{j+1} \approx a \Delta t + \sigma (u_{n-1}^j + u_{n+1}^j) + (1 - 2\sigma) u_n^j$$

The added term  $a \Delta t$  keeps the outer stream accelerating linearly. For SAE 30 oil,  $\nu = 3.25E-4 \text{ m}^2/\text{s}$ . As in Prob. 8.115 of this Manual, choose  $N = 15$ ,  $\Delta y = 0.005 \text{ m}$ ,  $\Delta t = 0.0333 \text{ s}$ ,  $\sigma = 0.433$ , and let  $u_1 = 0$  and  $u_N = u_{15} = at = 9t$ . All the inner nodes,  $2 < n < 14$ , are computed by the explicit relation just above. After 30 time-steps,  $t = 1 \text{ sec}$ , the tabulated velocities below show that the velocity at  $y = 1 \text{ cm}$  ( $n = 3$ ) is  $u_3 \approx 4.41 \text{ m/s}$ , and the position “ $\delta$ ” where  $u = 0.99u_\infty = 8.91 \text{ m/s}$  is at approximately **0.053** meters. *Ans.* These results are in good agreement with the known exact analytical solution for this flow.

j	Time	u1	u2	u3	u4	u5	u6	u7	u8	u9	u10	u11	u12	u13	u14	u15
31	1.00	0.000	2.496	<b>4.405</b>	5.832	6.871	7.607	8.114	8.453	8.673	8.811	<b>8.895</b>	8.944	8.972	8.988	9

**C8.3** Model potential flow through the upper-half of the symmetric diffuser shown below. The expansion angle is  $\theta = 18.5^\circ$ . Use a *non-square* mesh and calculate and plot (a) the velocity distribution; and (b) the pressure coefficient along the centerline (the bottom boundary).



**Fig. C8.3**

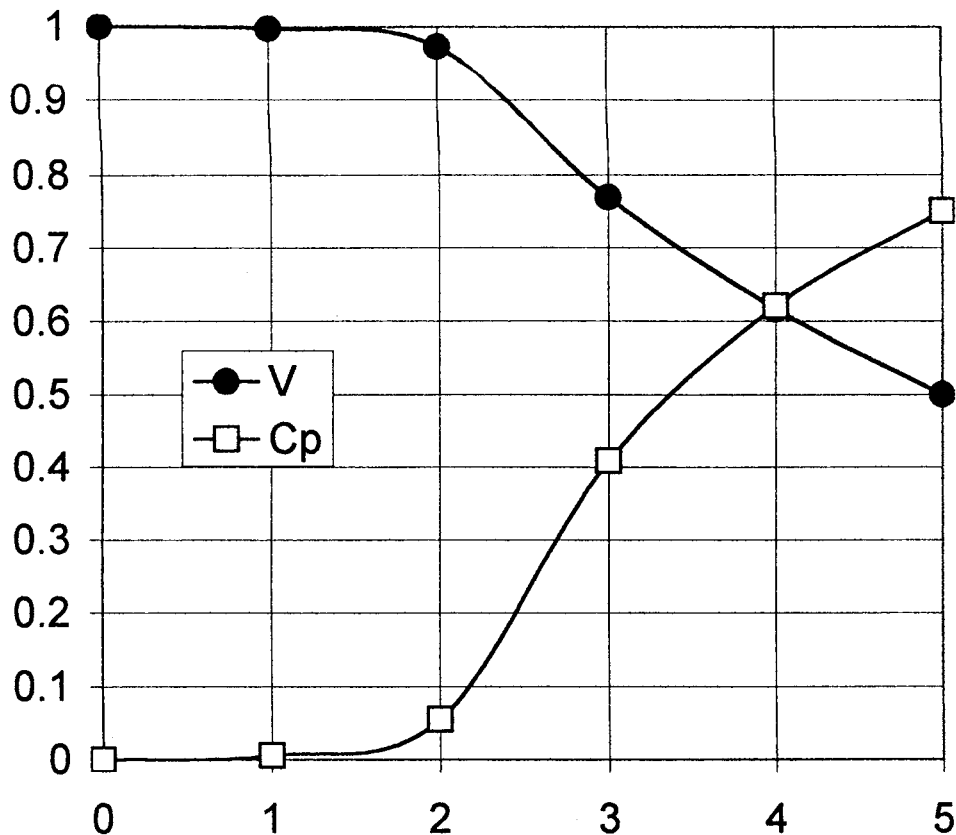
**Solution:** The tangent of  $18.5^\circ$  is 0.334, so  $L \approx 3h$  and 3:1 rectangles are appropriate. If we make them  $h$  long and  $h/3$  high, then  $i = 1$  to 6 and  $j = 1$  to 7. The model is given by Eq. (8.108) with  $\beta = (3/1)^2 = 9$ . That is,

$$2(1+9)\psi_{i,j} \approx \psi_{i-1,j} + \psi_{i+1,j} + 9(\psi_{i,j-1} + \psi_{i,j+1})$$

to be iterated over the internal nodes. For convenience, take  $\psi_{\text{top}} = 10,000$  and  $\psi_{\text{bottom}} = 0$ . The iterated nodal solutions are as follows:

i, j	1	2	3	4	5	6
1						10000
2					10000	8333
3				10000	8083	6667
4	10000	10000	10000	7604	6111	5000
5	6667	6657	6546	5107	4097	3333
6	3333	3324	3240	2563	2055	1667
7	0	0	0	0	0	0

The velocities are found by taking differences:  $u \approx \Delta\psi/\Delta y$  along the centerline. A plot is then made, as shown below, of velocity along the centerline ( $j = 7$ ). The pressure coefficient is defined by  $C_p = (p - p_{\text{entrance}})/[(1/2)\rho V_{\text{entrance}}^2]$ . These are also plotted on the graph, along the centerline, using Bernoulli's equation.



Velocity and Pressure Coefficient Distribution along the Centerline of the Diffuser in Problem C8.3, Assuming unit Velocity at the Entrance.

**C8.4** Use potential flow to approximate the flow of air being sucked into a vacuum cleaner through a 2-D slit attachment, as in the figure. Model the flow as a line sink of strength  $(-m)$ , with its axis in the  $z$ -direction at height  $a$  above the floor. (a) Sketch the streamlines and locate any stagnation points. (b) Find the velocity  $V(x)$  along the floor in terms of  $a$  and  $m$ . (c) Define a velocity scale  $U = m/a$  and plot the pressure coefficient  $C_p = (p - p_\infty)/[(1/2)\rho U^2]$  along the floor. (d) Find where  $C_p$  is a minimum—the vacuum cleaner should be most effective here. (e) Where did you *expect* the cleaner to be most effective, at  $x = 0$  or elsewhere? (Experiment with dust later.)

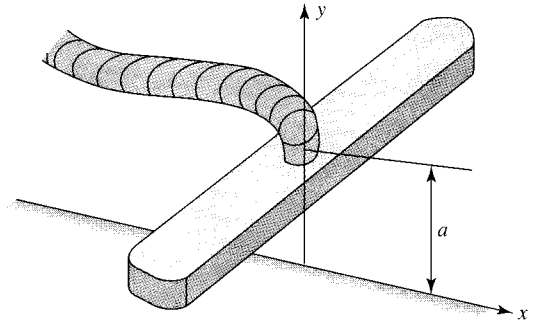
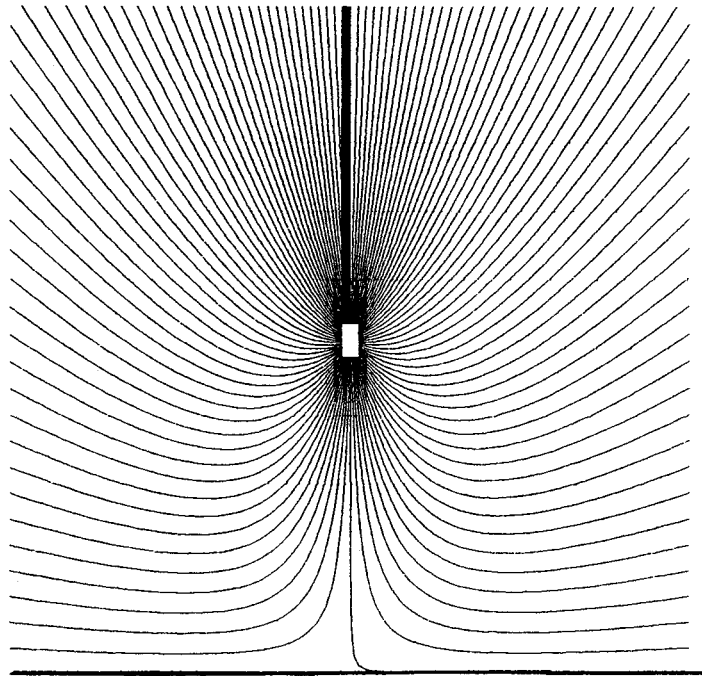


Fig. C8.4

**Solution:** (a) The “floor” is created by a sink at  $(0, +a)$  and an *image* sink at  $(0, -a)$ , exactly like Fig. 8.17a of the text. There is one stagnation point, at the *origin*. The streamlines are shown below in a plot constructed from a MATLAB contour. *Ans.* (a)



(b) At any point  $x$  along the wall, the velocity  $V$  is the sum of image flows:

$$V = 2v_{r,sink} \cos\theta = \frac{2m}{r} \frac{x}{r} = \frac{2mx}{x^2 + a^2} = V_{along\ wall} \quad \text{Ans. (b)}$$

(c) Use the Bernoulli equation to calculate pressure coefficient along the wall:

$$C_p = \frac{p - p_\infty}{(1/2)\rho U^2} = \frac{(1/2)\rho(U_\infty^2 - V^2)}{(1/2)\rho U^2} = -\frac{V^2}{U^2}; \quad C_{p,wall} = -\frac{4x^2 a^2}{(x^2 + a^2)^2} \quad \text{Ans. (c)}$$

(d) The minimum wall-pressure coefficient is found by differentiation:

$$\frac{dC_p}{dx} = 0 = \frac{d}{dx} \left[ \frac{-4x^2 a^2}{(x^2 + a^2)^2} \right] \text{ occurs at } x^2 = a^2, \text{ or: } x = \pm a \quad \text{Ans. (d)}$$

(e) Unexpected result! But experiments *do* show best cleaning at about  $x \approx \pm a$ .

**C8.5** Consider three-dimensional, incompressible, irrotational flow. Use two methods to prove that the viscous term in the Navier-Stokes equation is zero: (a) using vector notation; and (b) expanding out the scalar terms using irrotationality.

**Solution:** (a) For irrotational flow,  $\nabla \times \mathbf{V} = 0$ , and  $\mathbf{V} = \nabla \phi$ , so the viscous term may be rewritten in terms of  $\phi$  and then we get Laplace's equation:

$$\mu \nabla^2 \mathbf{V} = \mu \nabla^2 (\nabla \phi) = \mu \nabla (\nabla^2 \phi) \equiv 0 \text{ from Laplace's equation.} \quad \text{Ans. (a)}$$

(b) Expansion illustration: write out the  $x$ -term of  $\nabla^2 \mathbf{V}$ , using irrotationality:

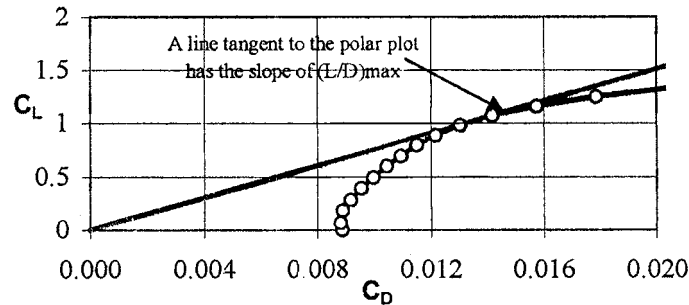
$$\frac{\partial^2 u}{\partial x^2} + \frac{\partial^2 u}{\partial y^2} + \frac{\partial^2 u}{\partial z^2} = \frac{\partial}{\partial x} \left( \frac{\partial u}{\partial x} \right) + \frac{\partial}{\partial y} \left( \frac{\partial v}{\partial x} \right) + \frac{\partial}{\partial z} \left( \frac{\partial w}{\partial x} \right) = \frac{\partial}{\partial x} \left( \frac{\partial u}{\partial x} + \frac{\partial v}{\partial y} + \frac{\partial w}{\partial z} \right) \equiv 0 \quad \text{Ans. (b)}$$

Similarly,  $\nabla^2 v = \nabla^2 w = 0$ . The viscous term always vanishes for irrotational flow.

**C8.6** Reconsider the lift-drag data for the NACA 4412 airfoil from Prob. 8.83. (a) Again draw the polar lift-drag plot and compare qualitatively with Fig. 7.26. (b) Find the maximum value of the lift-to-drag ratio. (c) Demonstrate a straight-line construction on the polar plot which will immediately yield the maximum  $L/D$  in (b). (d) If an aircraft could use this two-dimensional wing in actual flight (no induced drag) and had a perfect pilot, estimate how far (in miles) this aircraft could glide to a sea-level runway if it lost power at 25,000 ft altitude.



**Solution:** (a) Simply calculate  $C_L(\alpha)$  and  $C_D(\alpha)$  and plot them versus each other, as shown below:

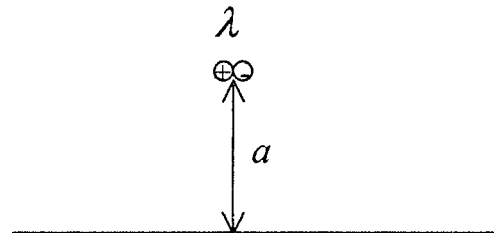


**Fig. C8.6**

(b, c) By calculating the ratio  $L/D$ , we could find a maximum value of **76** at  $\alpha = 9^\circ$ . *Ans.* (b) This can be found graphically by **drawing a tangent from the origin** to the polar plot. *Ans.* (c)

(d) If the pilot could glide down at a constant angle of attack of  $9^\circ$ , the airplane could coast to a maximum distance of  $(76)(25000 \text{ ft})/(5280 \text{ ft/mi}) = \mathbf{360 \text{ miles}}$ . *Ans.* (d)

**C8.7** Find a formula for the stream function for flow of a doublet of strength  $\lambda$  at a distance  $a$  from a wall, as in Fig. C8.7. (a) Sketch the streamlines. (b) Are there any stagnation points? (c) Find the maximum velocity along the wall and its position.

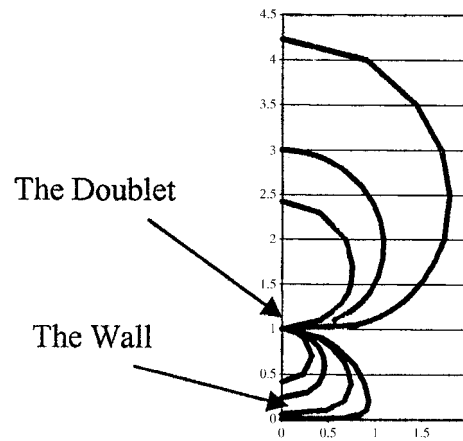


**Fig. C8.7**

**Solution:** Use an image doublet of the same strength and orientation at the  $(x, y) = (0, -a)$ . The stream function for this combined flow will form a “wall” at  $y = 0$  between the two doublets:

$$\psi = -\frac{\lambda(y+a)}{x^2 + (y+a)^2} - \frac{\lambda(y-a)}{x^2 + (y-a)^2}$$

(a) The streamlines are shown on the next page for one quadrant of the doubly-symmetric flow field. They are fairly circular, like Fig. 8.8, above the doublet, but they flatten near the wall.



Problem C8.7

(b) There are **no stagnation points** in this flow field. *Ans.* (b)

(c) The velocity along the wall ( $y = 0$ ) is found by differentiating the stream function:

$$u_{wall} = \frac{\partial \psi}{\partial y} \Big|_{y=0} = -\frac{\lambda}{x^2 + a^2} + \frac{2\lambda a^2}{(x^2 + a^2)^2} - \frac{\lambda}{x^2 + a^2} + \frac{2\lambda a^2}{(x^2 + a^2)^2}$$

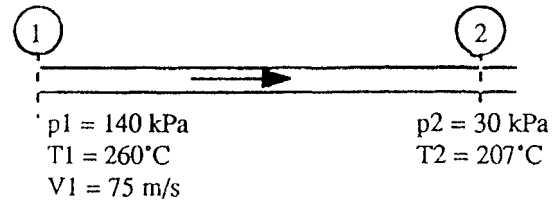
The maximum velocity occurs at  $x = 0$ , that is, right between the two doublets:

$$u_{w,\max} = \frac{2\lambda}{a^2} \quad \text{Ans. (c)}$$


---

## Chapter 9 • Compressible Flow

**9.1** An ideal gas flows adiabatically through a duct. At section 1,  $p_1 = 140$  kPa,  $T_1 = 260^\circ\text{C}$ , and  $V_1 = 75$  m/s. Farther downstream,  $p_2 = 30$  kPa and  $T_2 = 207^\circ\text{C}$ . Calculate  $V_2$  in m/s and  $s_2 - s_1$  in J/(kg·K) if the gas is (a) air,  $k = 1.4$ , and (b) argon,  $k = 1.67$ .



**Fig. P9.1**

**Solution:** (a) For air, take  $k = 1.40$ ,  $R = 287$  J/kg·K, and  $c_p = 1005$  J/kg·K. The adiabatic steady-flow energy equation (9.23) is used to compute the downstream velocity:

$$c_p T + \frac{1}{2} V^2 = \text{constant} = 1005(260) + \frac{1}{2}(75)^2 = 1005(207) + \frac{1}{2} V_2^2 \quad \text{or} \quad V_2 \approx 335 \frac{\text{m}}{\text{s}} \quad \text{Ans.}$$

$$\text{Meanwhile, } s_2 - s_1 = c_p \ln(T_2/T_1) - R \ln(p_2/p_1) = 1005 \ln\left(\frac{207 + 273}{260 + 273}\right) - 287 \ln\left(\frac{30}{140}\right),$$

$$\text{or } s_2 - s_1 = -105 + 442 \approx 337 \text{ J/kg} \cdot \text{K} \quad \text{Ans. (a)}$$

(b) For argon, take  $k = 1.67$ ,  $R = 208$  J/kg·K, and  $c_p = 518$  J/kg·K. Repeat part (a):

$$c_p T + \frac{1}{2} V^2 = 518(260) + \frac{1}{2}(75)^2 = 518(207) + \frac{1}{2} V_2^2, \quad \text{solve } V_2 = 246 \frac{\text{m}}{\text{s}} \quad \text{Ans.}$$

$$s_2 - s_1 = 518 \ln\left(\frac{207 + 273}{260 + 273}\right) - 208 \ln\left(\frac{30}{140}\right) = -54 + 320 \approx 266 \text{ J/kg} \cdot \text{K} \quad \text{Ans. (b)}$$

**9.2** Solve Prob. 9.1 if the gas is steam. Use two approaches: (a) an ideal gas from Table A.4; and (b) real steam from the steam tables [15].

**Solution:** For steam, take  $k = 1.33$ ,  $R = 461$  J/kg·K, and  $c_p = 1858$  J/kg·K. Then

$$c_p T + \frac{1}{2} V^2 = 1858(260) + \frac{1}{2}(75)^2 = 1858(207) + \frac{1}{2} V_2^2, \quad \text{solve } V_2 \approx 450 \frac{\text{m}}{\text{s}} \quad \text{Ans. (a)}$$

$$s_2 - s_1 = 1858 \ln\left(\frac{207 + 273}{260 + 273}\right) - 461 \ln\left(\frac{30}{140}\right) = -195 + 710 \approx 515 \text{ J/kg} \cdot \text{K} \quad \text{Ans. (a)}$$

(b) For real steam, we look up each enthalpy and entropy in the Steam Tables:

$$\text{at 140 kPa and } 260^\circ\text{C, read } h_1 = 2.993\text{E6 } \frac{\text{J}}{\text{kg}};$$

$$\text{at 30 kPa and } 207^\circ\text{C, } h_2 = 2.893\text{E6 } \frac{\text{J}}{\text{kg}}$$

$$\text{Then } h + \frac{1}{2}V^2 = 2.993\text{E6} + \frac{1}{2}(75)^2 = 2.893\text{E6} + \frac{1}{2}V_2^2, \text{ solve } V_2 \approx \mathbf{453} \frac{\text{m}}{\text{s}} \text{ Ans. (b)}$$

$$\text{at 140 kPa and } 260^\circ\text{C, read } s_1 = 7915 \frac{\text{J}}{\text{kg} \cdot \text{K}}, \text{ at 30 kPa and } 207^\circ\text{C, } s_2 = 8427 \frac{\text{J}}{\text{kg} \cdot \text{K}}$$

$$\text{Thus } s_2 - s_1 = 8427 - 7915 \approx \mathbf{512} \text{ J/kg} \cdot \text{K} \text{ Ans. (b)}$$

These are within  $\pm 1\%$  of the ideal gas estimates (a). Steam is nearly ideal in this range.

**9.3** If 8 kg of oxygen in a *closed tank* at  $200^\circ\text{C}$  and 300 kPa is heated until the pressure rises to 400 kPa, calculate (a) the new temperature; (b) the total heat transfer; and (c) the change in entropy.

**Solution:** For oxygen, take  $k = 1.40$ ,  $R = 260 \text{ J/kg} \cdot \text{K}$ , and  $c_v = 650 \text{ J/kg} \cdot \text{K}$ . Then

$$\rho_1 = \rho_2, \quad \therefore T_2 = T_1(p_2/p_1) = (200 + 273) \left( \frac{400}{300} \right) = 631 \text{ K} \approx \mathbf{358^\circ\text{C}} \text{ Ans. (a)}$$

$$Q = mc_v \Delta T = (8)(650)(358 - 200) \approx \mathbf{8.2\text{E5} \text{ J}} \text{ Ans. (b)}$$

$$s_2 - s_1 = mc_v \ln(T_2/T_1) = (8)(650) \ln \left( \frac{358 + 273}{200 + 273} \right) \approx \mathbf{1500} \frac{\text{J}}{\text{K}} \text{ Ans. (c)}$$

**9.4** Compressibility becomes important when the Mach number  $> 0.3$ . How fast can a two-dimensional cylinder travel in sea-level standard air before compressibility becomes important *somewhere* in its vicinity?

**Solution:** For sea-level air,  $T = 288 \text{ K}$ ,  $a = [1.4(287)(288)]^{1/2} = \mathbf{340} \text{ m/s}$ . Recall from Chap. 8 that incompressible theory predicts  $V_{\max} = 2U_\infty$  on a cylinder. Thus

$$Ma_{\max} = \frac{V_{\max}}{a} = \frac{2U_\infty}{340} = 0.3 \quad \text{when } U_\infty = \frac{0.3(340)}{2} \approx \mathbf{51} \frac{\text{m}}{\text{s}} = \mathbf{167} \frac{\text{ft}}{\text{s}} \text{ Ans.}$$

**9.5** Steam enters a nozzle at 377°C, 1.6 MPa, and a steady speed of 200 m/s and accelerates isentropically until it exits at saturation conditions. Estimate the exit velocity and temperature.

**Solution:** At saturation conditions, steam is *not ideal*. Use the Steam Tables:

At 377°C and 1.6 MPa, read  $h_1 = 3.205\text{E}6 \text{ J/kg}$  and  $s_1 = 7153 \text{ J/kg}\cdot\text{K}$

At *saturation* for  $s_1 = s_2 = 7153$ , read  $p_2 = 185 \text{ kPa}$ ,

$T_2 = 118^\circ\text{C}$ , and  $h_2 = 2.527\text{E}6 \text{ J/kg}$

$$\text{Then } h + \frac{1}{2}V^2 = 3.205\text{E}6 + \frac{1}{2}(200)^2 = 2.527\text{E}6 + \frac{1}{2}V_2^2, \text{ solve } V_2 \approx \mathbf{1180 \frac{m}{s}} \text{ Ans.}$$

This exit flow is **supersonic**, with a Mach number exceeding 2.0. We are assuming with this calculation that a (supersonic) shock wave does not form.

**9.6** Helium at 300°C and 200 kPa, in a closed container, is cooled to a pressure of 100 kPa. Estimate (a) the new temperature, in °C; and (b) the change in entropy, in J/(kg·K).

**Solution:** From Table A.4 for helium,  $k = 1.66$  and  $R = 2077 \text{ m}^2/\text{s}^2\cdot\text{K}$ . Convert 300°C to 573 K.

(a) The density is unchanged because the container is constant volume. Thus

$$\frac{p_2}{p_1} = \frac{100 \text{ kPa}}{200 \text{ kPa}} = \frac{\rho_2 RT_2}{\rho_1 RT_1} = \frac{T_2}{T_1} = \frac{T_2}{573 \text{ K}}, \text{ solve for } T_2 = 287 \text{ K} = \mathbf{14^\circ\text{C}} \text{ Ans. (a)}$$

(b) Evaluate  $c_p = kR/(k - 1) = 1.66(2077)/(1.66 - 1) = 5224 \text{ m}^2/\text{s}^2\cdot\text{K}$ . From Eq. (9.8),

$$\begin{aligned} s_2 - s_1 &= c_p \ln\left(\frac{T_2}{T_1}\right) - R \ln\left(\frac{p_2}{p_1}\right) = 5224 \ln\left(\frac{287 \text{ K}}{573 \text{ K}}\right) - 2077 \ln\left(\frac{100 \text{ kPa}}{200 \text{ kPa}}\right) \\ &= \mathbf{-2180 \frac{J}{kg\cdot K}} \text{ Ans. (b)} \end{aligned}$$

**9.7** Carbon dioxide ( $k = 1.28$ ) enters a constant-area duct at 400°F, 100 lbf/in<sup>2</sup> absolute, and 500 ft/s. Farther downstream the properties are  $V_2 = 1000 \text{ ft/s}$  and  $T_2 = 900^\circ\text{F}$ . Compute (a)  $p_2$ , (b) the heat added between sections, (c) the entropy change between sections, and (d) the mass flow per unit area. *Hint:* This problem requires the continuity equation.

**Solution:** For carbon dioxide, take  $k = 1.28$ ,  $R = 1130 \text{ ft}\cdot\text{lb}/\text{slug}\cdot^\circ\text{R}$ , and  $c_p = 5167 \text{ ft}\cdot\text{lb}/\text{slug}\cdot^\circ\text{R}$ . (a) The downstream pressure is computed from one-dimensional continuity:

$$\rho_1 A_1 V_1 = \rho_2 A_2 V_2, \text{ cancel } A, \quad \frac{P_1}{RT_1} V_1 = \frac{P_2}{RT_2} V_2, \text{ cancel } R,$$

$$\text{or: } p_2 = p_1 (T_2/T_1) (V_1/V_2) = 100 \left( \frac{900 + 460}{400 + 460} \right) \left( \frac{500}{1000} \right) = \mathbf{79 \text{ psia}} \quad \text{Ans. (a)}$$

(b) The steady-flow energy equation, with no shaft work, yields the heat transfer per mass:

$$q = c_p (T_2 - T_1) + \frac{1}{2} (V_2^2 - V_1^2) = 5167(900 - 400) + \frac{1}{2} [(1000)^2 - (500)^2]$$

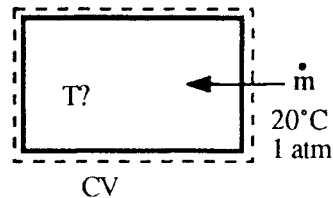
$$\text{or: } q = 2.96\text{E}6 \frac{\text{ft}\cdot\text{lb}}{\text{slug}} \div 32.2 \div 778.2 \approx \mathbf{118 \frac{\text{Btu}}{\text{lbm}}} \quad \text{Ans. (b)}$$

(c, d) Finally, the entropy change and mass flow follow from the properties known above:

$$s_2 - s_1 = 5167 \ln \left( \frac{900 + 460}{400 + 460} \right) - 1130 \ln \left( \frac{79}{100} \right) = 2368 + 266 \approx \mathbf{2630 \frac{\text{ft}\cdot\text{lb}}{\text{slug}\cdot^\circ\text{R}}} \quad \text{Ans. (c)}$$

$$\dot{m}/A = \rho_1 V_1 = \left[ \frac{100 \times 144}{1130(400 + 460)} \right] (500) \approx \mathbf{7.4 \frac{\text{slug}}{\text{s}\cdot\text{ft}^2}} \quad \text{Ans. (d)}$$

**9.8** Atmospheric air at  $20^\circ\text{C}$  enters and fills an insulated tank which is initially evacuated. Using a control-volume analysis from Eq. (3.63), compute the tank air temperature when it is full.



**Solution:** The energy equation during filling of the adiabatic tank is

$$\frac{dQ}{dt} + \frac{dW_{\text{shaft}}}{dt} = 0 + 0 = \frac{dE_{\text{CV}}}{dt} - h_{\text{atm}} \dot{m}_{\text{entering}}, \quad \text{or, after filling,}$$

$$E_{\text{CV,final}} - E_{\text{CV,initial}} = h_{\text{atm}} m_{\text{entered}}, \quad \text{or: } mc_v T_{\text{tank}} = mc_p T_{\text{atm}}$$

$$\text{Thus } T_{\text{tank}} = (c_p/c_v) T_{\text{atm}} = (1.4)(20 + 273) \approx \mathbf{410 \text{ K} = 137^\circ\text{C}} \quad \text{Ans.}$$

**9.9** Liquid hydrogen and oxygen are burned in a combustion chamber and fed through a rocket nozzle which exhausts at exit pressure equal to ambient pressure of  $54 \text{ kPa}$ . The nozzle exit diameter is  $45 \text{ cm}$ , and the jet exit density is  $0.15 \text{ kg}/\text{m}^3$ . If the exhaust gas has

a molecular weight of 18, estimate (a) the exit gas temperature; (b) the mass flow; and (c) the thrust generated by the rocket.

**NOTE:** *Sorry, we forgot to give the exit velocity, which is 1600 m/s.*

**Solution:** (a) From Eq. (9.3), estimate  $R_{\text{gas}}$  and hence the gas exit temperature:

$$R_{\text{gas}} = \frac{\Lambda}{M} = \frac{8314}{18} = 462 \frac{\text{J}}{\text{kg}\cdot\text{K}}, \quad \text{hence } T_{\text{exit}} = \frac{p}{R\rho} = \frac{54000}{462(0.15)} \approx \mathbf{779 \text{ K}} \quad \text{Ans. (a)}$$

(b) The mass flow follows from the velocity which we forgot to give:

$$\dot{m} = \rho AV = \left(0.15 \frac{\text{kg}}{\text{m}^3}\right) \frac{\pi}{4} (0.45)^2 (1600) \approx \mathbf{38 \frac{\text{kg}}{\text{s}}} \quad \text{Ans. (b)}$$

(c) The thrust was derived in Problem 3.68. When  $p_{\text{exit}} = p_{\text{ambient}}$ , we obtain

$$\text{Thrust} = \rho_e A_e V_e^2 = \dot{m} V_e = 38(1600) \approx \mathbf{61,100 \text{ N}} \quad \text{Ans. (c)}$$

**9.10** A certain aircraft flies at the same Mach number regardless of its altitude. Compared to its speed at 12000-m Standard Altitude, it flies 127 km/h faster at sea level. Determine its Mach number.

**Solution:** At sea level,  $T_1 = 288.16 \text{ K}$ . At 12000 m standard,  $T_2 = 216.66 \text{ K}$ . Then

$$a_1 = \sqrt{kRT_1} = \sqrt{1.4(287)(288.16)} = 340.3 \frac{\text{m}}{\text{s}}; \quad a_2 = \sqrt{kRT_2} = 295.0 \frac{\text{m}}{\text{s}}$$

$$\text{Then } \Delta V_{\text{plane}} = \text{Ma}(a_2 - a_1) = \text{Ma}(340.3 - 295.0) = [127 \text{ km/h}] = 35.27 \text{ m/s}$$

$$\text{Solve for } \mathbf{Ma} = \frac{35.27}{45.22} \approx \mathbf{0.78} \quad \text{Ans.}$$

**9.11** At 300°C and 1 atm, estimate the speed of sound of (a) nitrogen; (b) hydrogen; (c) helium; (d) steam; and (e) uranium hexafluoride  $^{238}\text{UF}_6$  ( $k \neq 1.06$ ).

**Solution:** The gas constants are listed in Appendix Table A.4 for all but uranium gas (e):

(a) nitrogen:  $k = 1.40$ ,  $R = 297$ ,  $T = 300 + 273 = 573 \text{ K}$ :

$$a = \sqrt{kRT} = \sqrt{1.40(297)(573)} \approx \mathbf{488 \text{ m/s}} \quad \text{Ans. (a)}$$

(b) hydrogen:  $k = 1.41$ ,  $R = 4124$ ,  $a = \sqrt{1.41(4124)(573)} \approx \mathbf{1825 \text{ m/s}} \quad \text{Ans. (b)}$

(c) helium:  $k = 1.66$ ,  $R = 2077$ :  $a = \sqrt{1.66(2077)(573)} \approx \mathbf{1406 \text{ m/s}} \quad \text{Ans. (c)}$

(d) steam:  $k = 1.33$ ,  $R = 461$ :  $a = \sqrt{1.33(461)(573)} \approx \mathbf{593 \text{ m/s}}$  *Ans. (d)*

(e) For uranium hexafluoride, we need only to compute  $R$  from the molecular weight:

$$(e) {}^{238}\text{UF}_6: M = 238 + 6(19) = 352, \therefore R = \frac{8314}{352} \approx 23.62 \text{ m}^2/\text{s}^2 \cdot \text{K}$$

$$\text{then } a = \sqrt{1.06(23.62)(573)} \approx \mathbf{120 \text{ m/s}}$$
 *Ans. (e)*

**9.12** Assume that water follows Eq. (1.19) with  $n \approx 7$  and  $B \approx 3000$ . Compute the bulk modulus (in kPa) and the speed of sound (in m/s) at (a) 1 atm; and (b) 1100 atm (the deepest part of the ocean). (c) Compute the speed of sound at 20°C and 9000 atm and compare with the measured value of 2650 m/s (A. H. Smith and A. W. Lawson, *J. Chem. Phys.*, vol. 22, 1954, p. 351).

**Solution:** We may compute these values by differentiating Eq. (1.19) with  $k \approx 1.0$ :

$$\frac{p}{p_a} = (B+1)(\rho/\rho_a)^n - B; \quad \text{Bulk modulus } K = \rho \frac{dp}{d\rho} = n(B+1)p_a(\rho/\rho_a)^n, \quad a = \sqrt{K/\rho}$$

We may then substitute numbers for water, with  $p_a = 101350 \text{ Pa}$  and  $\rho_a = 998 \text{ kg/m}^3$ :

$$(a) \text{ at 1 atm: } K_{\text{water}} = 7(3001)(101350)(1)^7 \approx \mathbf{2.129E9 \text{ Pa}}$$
 (21007 atm) *Ans. (a)*

$$\text{speed of sound } a_{\text{water}} = \sqrt{K/\rho} = \sqrt{2.129E9/998} \approx \mathbf{1460 \text{ m/s}}$$
 *Ans. (a)*

$$(b) \text{ at 1100 atm: } \rho = 998 \left( \frac{1100 + 3000}{3001} \right)^{1/7} = 998(1.0456) \approx 1044 \text{ kg/m}^3$$

$$K = K_{\text{atm}}(1.0456)^7 = (2.129E9)(1.3665) = \mathbf{2.91E9 \text{ Pa}}$$
 (28700 atm) *Ans. (b)*

$$a = \sqrt{K/\rho} = \sqrt{2.91E9/1044} \approx \mathbf{1670 \text{ m/s}}$$
 *Ans. (b)*

$$(c) \text{ at 9000 atm: } \rho = 998 \left( \frac{9000 + 3000}{3001} \right)^{1/7} = 1217 \frac{\text{kg}}{\text{m}^3}; \quad K = K_a \left( \frac{1217}{998} \right)^7,$$

$$\text{or: } K = 8.51E9 \text{ Pa}, \quad a = \sqrt{K/\rho} = \sqrt{8.51E9/1217} \approx \mathbf{2645 \text{ m/s}}$$
 (within 0.2%) *Ans. (c)*

**9.13** Assume that the airfoil of Prob. 8.84 is flying at the same angle of attack at 6000 m standard altitude. Estimate the forward velocity, in mi/h, at which supersonic flow (and possible shock waves) will appear on the airfoil surface.

**Solution:** At 6000 m, from Table A.6,  $a = 316.5 \text{ m/s}$ . From the data of Prob. 8.84, the highest surface velocity is about  $1.29U_\infty$  and occurs at about the quarter-chord point.



When that velocity reaches the speed of sound, shock waves may begin to form:

$$a = 316.5 \text{ m/s} = 1.29U_\infty, \quad \text{hence } U_\infty \approx 245 \text{ m/s} = \mathbf{549 \text{ mi/h}} \quad \text{Ans.}$$

**9.14** Assume steady adiabatic flow of a perfect gas. Show that the energy Eq. (9.21), when plotted as  $a$  versus  $V$ , forms an ellipse. Sketch this ellipse; label the intercepts and the regions of subsonic, sonic, and supersonic flow; and determine the ratio of the major and minor axes.

**Solution:** In Eq. (9.21), simply replace enthalpy by its equivalent in speed of sound:

$$h + \frac{1}{2}V^2 = \text{constant} = c_p T + \frac{1}{2}V^2 = \frac{kR}{k-1}T + \frac{1}{2}V^2 = \frac{a^2}{k-1} + \frac{1}{2}V^2,$$

$$\text{or: } a^2 + \frac{k-1}{2}V^2 = \text{constant} = a_0^2 = \frac{k-1}{2}V_{\max}^2 \quad (\text{ellipse}) \quad \text{Ans.}$$

This ellipse is shown below. The axis ratio is  $V_{\max}/a_0 = [2/(k-1)]^{1/2}$ . *Ans.*

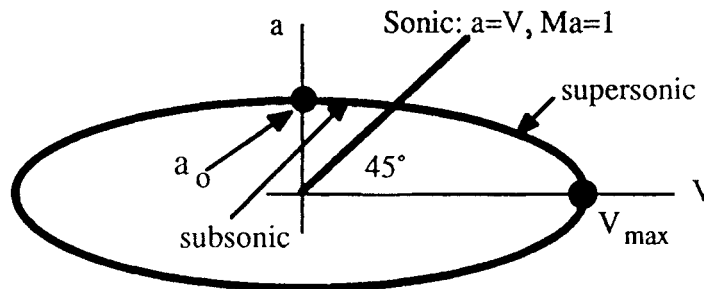


Fig. P9.14

**9.15** A weak pressure wave (sound wave), with a pressure change  $\Delta p \approx 40$  Pa, propagates through still air at  $20^\circ\text{C}$  and 1 atm. Estimate (a) the density change; (b) the temperature change; and (c) the velocity change across the wave.

**Solution:** For air at  $20^\circ\text{C}$ , speed of sound  $a \approx 343$  m/s, and  $\rho = 1.2$  kg/m<sup>3</sup>. Then

$$\Delta p \approx \rho C \Delta V, \quad C \approx a, \quad \text{thus } 40 = (1.2)(343)\Delta V, \quad \text{solve for } \Delta V \approx \mathbf{0.097 \frac{m}{s}} \quad \text{Ans. (a)}$$

$$\Delta \rho = (\rho + \Delta \rho) \frac{\Delta V}{C} = (1.2 + \Delta \rho) \frac{0.097}{343}, \quad \text{solve for } \Delta \rho \approx \mathbf{0.00034 \text{ kg/m}^3} \quad \text{Ans. (b)}$$

$$\frac{T + \Delta T}{T} \approx \left( \frac{p + \Delta p}{p} \right)^{(k-1)/k}, \quad \text{or: } \frac{293 + \Delta T}{293} \approx \left( \frac{101350 + 40}{101350} \right)^{0.4/1.4}, \quad \Delta T \approx \mathbf{0.033 \text{ K}} \quad \text{Ans. (c)}$$

**9.16** A weak pressure wave (sound wave)  $\Delta p$  propagates through still air. Discuss the type of reflected pulse which occurs, and the boundary conditions which must be satisfied, when the wave strikes normal to, and is reflected from, (a) a solid wall; and (b) a free liquid surface.

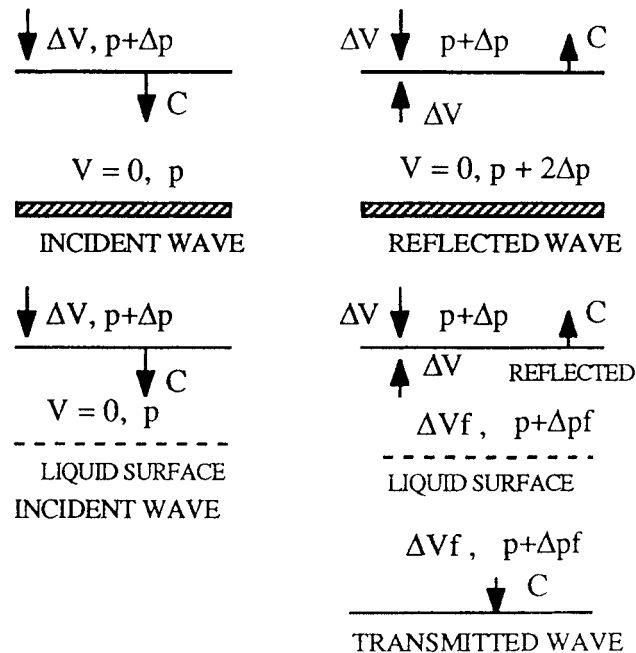


Fig. P9.16

**Solution:** (a) When reflecting from a solid wall, the velocity to the wall must be zero, so the wall pressure rises to  $p + 2\Delta p$  to create a compression wave which cancels out the oncoming particle motion  $\Delta V$ .

(b) When a compression wave strikes a liquid surface, it reflects and transmits to keep the particle velocity  $\Delta V_f$  and the pressure  $p + \Delta p_f$  the same across the liquid interface:

$$\Delta V_f = \frac{2\rho C \Delta V}{\rho C + \rho_{\text{liq}} C_{\text{liq}}}; \quad \Delta p_f = \frac{2\rho_{\text{liq}} C_{\text{liq}} \Delta p}{\rho C + \rho_{\text{liq}} C_{\text{liq}}} \quad \text{Ans. (b)}$$

If  $\rho_{\text{liq}} C_{\text{liq}} \gg \rho C$  of air, then  $\Delta V_f \approx 0$  and  $\Delta p_f \approx 2\Delta p$ , which is case (a) above.

**9.17** A submarine at a depth of 800 m sends a sonar signal and receives the reflected wave back from a similar submerged object in 15 s. Using Prob. 9.12 as a guide, estimate the distance to the other object.

**Solution:** It probably makes little difference, but estimate  $a$  at a depth of 800 m:

$$\text{at 800 m, } p = 101350 + 1025(9.81)(800) = 8.15\text{E}6 \text{ Pa} = 80.4 \text{ atm}$$

$$p/p_a = 80.4 = 3001(\rho/1025)^7 - 3000, \quad \text{solve } \rho \approx 1029 \text{ kg/m}^3$$

$$a = \sqrt{n(B+1)p_a(\rho/\rho_a)^7/\rho} = \sqrt{7(3001)(101350)(1029/1025)^7/1029} \approx 1457 \text{ m/s}$$

Hardly worth the trouble: One-way distance  $\approx a\Delta t/2 = 1457(15/2) \approx \mathbf{10900 \text{ m}}$ . *Ans.*

---

**9.18** Race cars at the Indianapolis Speedway average speeds of 185 mi/h. After determining the altitude of Indianapolis, find the Mach number of these cars and estimate whether compressibility might affect their aerodynamics.

**Solution:** Rush to the Almanac and find that Indianapolis is at 220 m altitude, for which Table A.6 predicts that the standard speed of sound is 339.4 m/s = 759 mi/h. Thus the Mach number is

$$\text{Ma}_{\text{racer}} = V/a = 185 \text{ mph}/759 \text{ mph} = \mathbf{0.24} \quad \text{Ans.}$$

This is less than 0.3, so the Indianapolis Speedway need not worry about compressibility.

---

**9.19** The Concorde aircraft flies at  $\text{Ma} \approx 2.3$  at 11-km standard altitude. Estimate the temperature in °C at the front stagnation point. At what Mach number would it have a front stagnation point temperature of 450°C?

**Solution:** At 11-km standard altitude,  $T \approx 216.66 \text{ K}$ ,  $a = \sqrt{kRT} = 295 \text{ m/s}$ . Then

$$T_{\text{nose}} = T_o = T \left( 1 + \frac{k-1}{2} \text{Ma}^2 \right) = 216.66 [1 + 0.2(2.3)^2] = 446 \text{ K} \approx \mathbf{173^\circ\text{C}} \quad \text{Ans.}$$

If, instead,  $T_o = 450^\circ\text{C} = 723 \text{ K} = 216.66(1 + 0.2 \text{Ma}^2)$ , solve  $\text{Ma} \approx \mathbf{3.42}$  *Ans.*

---

**9.20** A gas flows at  $V = 200 \text{ m/s}$ ,  $p = 125 \text{ kPa}$ , and  $T = 200^\circ\text{C}$ . For (a) air and (b) helium, compute the maximum pressure and the maximum velocity attainable by expansion or compression.

**Solution:** Given  $(V, p, T)$ , we can compute  $\text{Ma}$ ,  $T_o$  and  $p_o$  and then  $V_{\text{max}} = \sqrt{2c_p T_o}$ :

$$\text{(a) air: } \text{Ma} = \frac{V}{\sqrt{kRT}} = \frac{200}{\sqrt{1.4(287)(200+273)}} = \frac{200}{436} = 0.459$$

$$\text{Then } p_{\text{max}} = p_o = p \left( 1 + \frac{k-1}{2} \text{Ma}^2 \right)^{k/(k-1)} = 125 [1 + 0.2(0.459)^2]^{3.5} \approx \mathbf{144 \text{ kPa}} \quad \text{Ans. (a)}$$

$$T_o = (200 + 273) [1 + 0.2(0.459)^2] = 493 \text{ K}, \quad V_{\text{max}} = \sqrt{2(1005)(493)} \approx \mathbf{995 \text{ m/s}} \quad \text{Ans. (a)}$$

(b) For helium,  $k = 1.66$ ,  $R = 2077 \text{ m}^2/\text{s}^2 \cdot \text{K}$ ,  $c_p = kR/(k - 1) = 5224 \text{ m}^2/\text{s}^2 \cdot \text{K}$ . Then

$$Ma = 200/\sqrt{1.66(2077)(473)} \approx 0.157, \quad p_o = 125[1 + 0.33(0.157)^2]^{1.66/0.66} \approx \mathbf{128 \text{ kPa}}$$

$$T_o = 473[1 + 0.33(0.157)^2] = 477 \text{ K}, \quad V_{\max} = \sqrt{2(5224)(477)} \approx \mathbf{2230 \text{ m/s}} \quad \text{Ans. (b)}$$

**9.21**  $\text{CO}_2$  expands isentropically through a duct from  $p_1 = 125 \text{ kPa}$  and  $T_1 = 100^\circ\text{C}$  to  $p_2 = 80 \text{ kPa}$  and  $V_2 = 325 \text{ m/s}$ . Compute (a)  $T_2$ ; (b)  $Ma_2$ ; (c)  $T_o$ ; (d)  $p_o$ ; (e)  $V_1$ ; and (f)  $Ma_1$ .

**Solution:** For  $\text{CO}_2$ , from Table A.4, take  $k = 1.30$  and  $R = 189 \text{ J/kg} \cdot \text{K}$ . Compute the specific heat:  $c_p = kR/(k - 1) = 1.3(189)/(1.3 - 1) = 819 \text{ J/kg} \cdot \text{K}$ . The results follow in sequence:

$$(a) \quad T_2 = T_1(p_2/p_1)^{(k-1)/k} = (373 \text{ K})(80/125)^{(1.3-1)/1.3} = \mathbf{336 \text{ K}} \quad \text{Ans. (a)}$$

$$(b) \quad a_2 = \sqrt{kRT_2} = \sqrt{(1.3)(189)(336)} = 288 \text{ m/s}, \quad Ma_2 = V_2/a_2 = 325/288 = \mathbf{1.13} \quad \text{Ans. (b)}$$

$$(c) \quad T_{o1} = T_{o2} = T_2 \left( 1 + \frac{k-1}{2} Ma_2^2 \right) = (336) \left[ 1 + \frac{0.3}{2} (1.13)^2 \right] = \mathbf{401 \text{ K}} \quad \text{Ans. (c)}$$

$$(d) \quad p_{o1} = p_{o2} = p_2 \left( 1 + \frac{k-1}{2} Ma_2^2 \right)^{1.3/(1.3-1)} = (80) \left[ 1 + \frac{0.3}{2} (1.13)^2 \right]^{1.3/0.3} = \mathbf{171 \text{ kPa}} \quad \text{Ans. (d)}$$

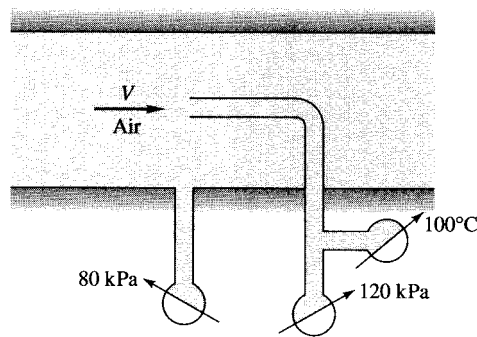
$$(e) \quad T_{o1} = 401 \text{ K} = T_1 + \frac{V_1^2}{2c_p} = 373 + \frac{V_1^2}{2(819)}, \quad \text{Solve for } \mathbf{V_1 = 214 \text{ m/s}} \quad \text{Ans. (e)}$$

$$(f) \quad a_1 = \sqrt{kRT_1} = \sqrt{(1.3)(189)(373)} = 303 \text{ m/s}, \quad Ma_1 = V_1/a_1 = 214/303 = \mathbf{0.71} \quad \text{Ans. (f)}$$

**9.22** Given the pitot stagnation temperature and pressure and the static-pressure measurements in Fig. P9.22, estimate the air velocity  $V$ , assuming (a) incompressible flow and (b) compressible flow.

**Solution:** Given  $p = 80 \text{ kPa}$ ,  $p_o = 120 \text{ kPa}$ , and  $T = 100^\circ\text{C} = 373 \text{ K}$ . Then

$$\rho_o = \frac{p_o}{RT_o} = \frac{120000}{287(373)} = 1.12 \text{ kg/m}^3$$



**Fig. P9.22**

(a) ‘Incompressible’:

$$\rho = \rho_o, \quad V \approx \sqrt{\frac{2\Delta p}{\rho}} = \sqrt{\frac{2(120000 - 80000)}{1.12}} \approx 267 \frac{\text{m}}{\text{s}} \quad (7\% \text{ low}) \quad \text{Ans. (a)}$$

(b) Compressible:  $T = T_o(p/p_o)^{(k-1)/k} = 373(80/120)^{0.4/1.4} = 332 \text{ K}$ . Then  $T_o = 373 \text{ K} = T + V^2/2c_p = 332 + V^2/[2(1005)]$ , solve for  $V = 286 \text{ m/s}$ . *Ans. (b)*

**9.23** A large rocket engine delivers hydrogen at  $1500^\circ\text{C}$  and  $3 \text{ MPa}$ ,  $k = 1.41$ ,  $R = 4124 \text{ J/kg}\cdot\text{K}$ , to a nozzle which exits with gas pressure equal to the ambient pressure of  $54 \text{ kPa}$ . Assuming isentropic flow, if the rocket thrust is  $2 \text{ MN}$ , estimate (a) the exit velocity; and (b) the mass flow of hydrogen.

**Solution:** Compute  $c_p = kR/(k-1) = 14180 \text{ J/kg}\cdot\text{K}$ . For isentropic flow, compute

$$\rho_o = \frac{p_o}{RT_o} = \frac{3E6}{4124(1773)} = 0.410 \frac{\text{kg}}{\text{m}^3}, \quad \therefore \rho_e = \rho_o \left(\frac{p_e}{p_o}\right)^{\frac{1}{k}} = 0.410 \left(\frac{54E3}{3E6}\right)^{\frac{1}{1.41}} = 0.0238 \frac{\text{kg}}{\text{m}^3}$$

$$T_e = \frac{54000}{4124(0.0238)} = 551 \text{ K}, \quad T_o = 1773 = 551 + \frac{V_e^2}{2(14180)},$$

$$\text{Solve } V_{\text{exit}} \approx 5890 \frac{\text{m}}{\text{s}} \quad \text{Ans. (a)}$$

$$\text{From Prob. 3.68, } Thrust = 2E6 \text{ N} = \dot{m}V_e = \dot{m}(5890), \quad \text{solve } \dot{m} \approx 340 \frac{\text{kg}}{\text{s}} \quad \text{Ans. (b)}$$

**9.24** For low-speed (nearly incompressible) gas flow, the stagnation pressure can be computed from Bernoulli’s equation

$$p_0 = p + \frac{1}{2}\rho V^2$$

(a) For higher subsonic speeds, show that the isentropic relation (9.28a) can be expanded in a power series as follows:

$$p_0 \approx p + \frac{1}{2}\rho V^2 \left( 1 + \frac{1}{4}\text{Ma}^2 + \frac{2-k}{24}\text{Ma}^4 + \dots \right)$$

(b) Suppose that a pitot-static tube in air measures the pressure difference  $p_0 - p$  and uses the Bernoulli relation, with stagnation density, to estimate the gas velocity. At what Mach number will the error be 4 percent?

**Solution:** Expand the isentropic formula into a binomial series:

$$\begin{aligned}\frac{p_o}{p} &= \left(1 + \frac{k-1}{2} \text{Ma}^2\right)^{k/(k-1)} = 1 + \frac{k}{k-1} \frac{k-1}{2} \text{Ma}^2 + \frac{k}{k-1} \frac{1}{2} \left(\frac{k}{k-1} - 1\right) \left(\frac{k-1}{2} \text{Ma}^2\right)^2 + \dots \\ &= 1 + \frac{k}{2} \text{Ma}^2 + \frac{k}{8} \text{Ma}^4 + \frac{k(2-k)}{48} \text{Ma}^6 + \dots\end{aligned}$$

Use the ideal gas identity  $(1/2)\rho V^2 \equiv (1/2)k\rho(\text{Ma}^2)$  to obtain

$$\frac{p_o - p}{(1/2)\rho V^2} = 1 + \frac{1}{4} \text{Ma}^2 + \frac{2-k}{24} \text{Ma}^4 + \dots \quad \text{Ans.}$$

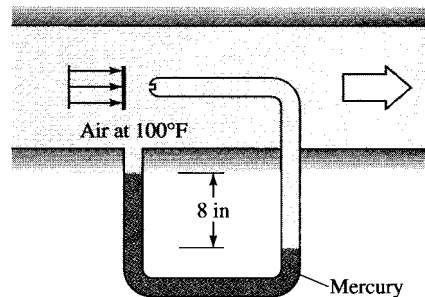
The error in the incompressible formula,  $2\Delta p/\rho_o V^2$ , is 4% when

$$\begin{aligned}\frac{V}{\sqrt{2(p_o - p)/\rho}} &= \sqrt{\frac{\rho_o/\rho}{1 + (1/4)\text{Ma}^2 + [(2-k)/24]\text{Ma}^4}} = 1.04, \\ \text{where } \frac{\rho_o}{\rho} &= \left(1 + \frac{k-1}{2} \text{Ma}^2\right)^{1/(k-1)}\end{aligned}$$

For  $k = 1.4$ , solve this for 4% error at  $\text{Ma} \approx 0.576$  Ans.

**9.25** If it is known that the air velocity in the duct is 750 ft/s, use that mercury manometer measurement in Fig. P9.25 to estimate the static pressure in the duct, in psia.

**Solution:** Estimate the air specific weight in the manometer to be, say, 0.07 lbf/ft<sup>3</sup>. Then



**Fig. P9.25**

$$p_o - p|_{\text{measured}} = (\rho g_{\text{mercury}} - \rho g_{\text{air}})h = (846 - 0.07) \left(\frac{8}{12} \text{ ft}\right) \approx 564 \text{ lbf/ft}^2$$

$$\text{Given } T = 100^\circ\text{F} = 560^\circ\text{R}, \quad a = \sqrt{kRT} = \sqrt{1.4(1717)(560)} \approx 1160 \text{ ft/s}$$

$$\text{Then } \text{Ma} = V/a = 750/1160 \approx 0.646$$

$$\text{Finally, } \frac{p_o - p}{p} = [1 + 0.2(0.646)^2]^{3.5} - 1 = 1.324 - 1 = 0.324 = \frac{564}{p}$$

$$\text{Solve for } p_{\text{static}} \approx 1739 \text{ psf} \approx \mathbf{12.1 \text{ lbf/in}^2} \text{ (abs)} \quad \text{Ans.}$$

**9.26** Show that for isentropic flow of a perfect gas if a pitot-static probe measures  $p_0$ ,  $p$ , and  $T_0$ , the gas velocity can be calculated from

$$V^2 = 2c_p T_0 \left[ 1 - \left( \frac{p}{p_0} \right)^{(k-1)/k} \right]$$

What would be a source of error if a shock wave were formed in front of the probe?

**Solution:** Assuming isentropic flow past the probe,

$$T = T_0 (p/p_0)^{(k-1)/k} = T_0 - \frac{V^2}{2c_p}, \quad \text{solve } V^2 = 2c_p T_0 \left[ 1 - \left( \frac{p}{p_0} \right)^{(k-1)/k} \right] \quad \text{Ans.}$$

If there is a *shock wave* formed in front of the probe, this formula will yield the air velocity inside the shock wave, because the probe measures  $p_{o2}$  *inside* the shock. The stagnation pressure in the outer stream is *greater*, as is the velocity outside the shock.

---

**9.27** In many problems the sonic (\*) properties are more useful reference values than the stagnation properties. For isentropic flow of a perfect gas, derive relations for  $p/p^*$ ,  $T/T^*$ , and  $\rho/\rho^*$  as functions of the Mach number. Let us help by giving the density-ratio formula:

$$\rho/\rho^* = \left[ \frac{k+1}{2+(k-1)\text{Ma}^2} \right]^{1/(k-1)}$$

**Solution:** Simply introduce (and then cancel out) the stagnation properties:

$$\frac{\rho}{\rho^*} = \frac{\rho/\rho_0}{\rho^*/\rho_0} = \frac{\left( 1 + \frac{k-1}{2}\text{Ma}^2 \right)^{-1/(k-1)}}{\left( 1 + \frac{k-1}{2} \right)^{-1/(k-1)}} \equiv \left[ \frac{k+1}{2+(k-1)\text{Ma}^2} \right]^{1/(k-1)} \quad \text{Ans.}$$

$$\text{similarly, } \frac{p}{p^*} = \frac{p/p_0}{p^*/p_0} \equiv \left[ \frac{k+1}{2+(k-1)\text{Ma}^2} \right]^{k/(k-1)} \quad \text{and} \quad \frac{T}{T^*} = \frac{T/T_0}{T^*/T_0} = \frac{k+1}{2+(k-1)\text{Ma}^2} \quad \text{Ans.}$$


---

**9.28** A large vacuum tank, held at 60 kPa absolute, sucks sea-level standard air through a converging nozzle of throat diameter 3 cm. Estimate (a) the mass flow rate; and (b) the Mach number at the throat.

**Solution:** For sea-level air take  $T_o = 288$  K,  $\rho_o = 1.225$  kg/m<sup>3</sup>, and  $p_o = 101350$  Pa. The pressure ratio is given, and we can assume isentropic flow with  $k = 1.4$ :

$$\frac{p_e}{p_o} = \frac{60000}{101350} = \left(1 + 0.2Ma_e^2\right)^{-3.5}, \quad \text{solve } \mathbf{Ma_e \approx 0.899} \quad \text{Ans. (b)}$$

We can then solve for exit temperature, density, and velocity, finally mass flow:

$$\rho_e = \rho_o [1 + 0.2(0.899)^2]^{-2.5} \approx 0.842 \frac{\text{kg}}{\text{m}^3}, \quad T_e = \frac{p_e}{R\rho_e} = \frac{60000}{287(0.842)} \approx 248 \text{ K}$$

$$V_e = Ma_e a_e = 0.899 [1.4(287)(248)]^{1/2} \approx 284 \frac{\text{m}}{\text{s}}$$

$$\text{Finally, } \dot{m} = \rho_e A_e V_e = (0.842) \frac{\pi}{4} (0.03)^2 (284) \approx \mathbf{0.169} \frac{\text{kg}}{\text{s}} \quad \text{Ans. (a)}$$

**9.29** Steam from a large tank, where  $T = 400^\circ\text{C}$  and  $p = 1$  MPa, expands isentropically through a small nozzle until, at a section of 2-cm diameter, the pressure is 500 kPa. Using the Steam Tables, estimate (a) the temperature; (b) the velocity; and (c) the mass flow at this section. Is the flow subsonic?

**Solution:** “Large tank” is code for stagnation values, thus  $T_o = 400^\circ\text{C}$  and  $p_o = 1$  MPa. This problem involves dogwork in the tables and well illustrates why we use the ideal-gas law so readily. Using  $k \approx 1.33$  for steam, we find the flow is slightly supersonic:

$$\text{Ideal-gas simplification: } \frac{p_o}{p} = \frac{1000}{500} = 2.0 \approx \left[1 + \left(\frac{1.33-1}{2}\right) Ma^2\right]^{1.33},$$

$$\text{Solve } \mathbf{Ma \approx 1.08}$$

That was quick. Instead, plow about in the S.I. Steam Tables, assuming constant entropy:

$$\text{At } T_o = 400^\circ\text{C} \quad \text{and } p_o = 1 \text{ MPa, read } s_o \approx 7481 \frac{\text{J}}{\text{kg}\cdot\text{K}} \quad \text{and } h_o \approx 3.264\text{E}6 \frac{\text{J}}{\text{kg}}$$

$$\text{Then, at } p = 0.5 \text{ MPa, assuming } s = s_o, \quad \text{read } T \approx 304^\circ\text{C} \approx \mathbf{577 \text{ K}} \quad \text{Ans. (a)}$$

$$\text{Also read } h \approx 3.074\text{E}6 \text{ J/kg} \quad \text{and } \rho \approx 1.896 \text{ kg/m}^3.$$



With  $h$  and  $h_o$  known, the velocity follows from the adiabatic energy equation:

$$h + V^2/2 = h_o, \quad \text{or} \quad 3.074\text{E}6 + V^2/2 = 3.264\text{E}6 \frac{\text{J}}{\text{kg}} \left( \text{or} \frac{\text{m}^2}{\text{s}^2} \right),$$

$$\text{Solve} \quad V \approx \mathbf{618} \frac{\text{m}}{\text{s}} \quad \text{Ans. (b)}$$

The speed of sound is not in *my* Steam Tables, however, the “isentropic exponent” is:

$$\gamma_{\text{isen}} \approx 1.298 \text{ at } p = 500 \text{ kPa and } T = 304^\circ\text{C. Then} \quad a \approx \sqrt{\frac{\gamma p}{\rho}} = \sqrt{\frac{1.298(5\text{E}5)}{1.896}} \approx 585 \frac{\text{m}}{\text{s}}$$

$$\text{Then} \quad \text{Ma} = V/a = \frac{618}{585} \approx \mathbf{1.06} \quad \text{Ans. (c)} \quad (\text{slightly supersonic})$$

We could have done nearly as well ( $\pm 2\%$ ) by simply assuming an ideal gas with  $k \approx 1.33$ .

**9.30** Oxygen flows in a duct of diameter 5 cm. At one section,  $T_o = 300^\circ\text{C}$ ,  $p = 120 \text{ kPa}$ , and the mass flow is  $0.4 \text{ kg/s}$ . Estimate, at this section, (a)  $V$ ; (b)  $\text{Ma}$ ; and (c)  $\rho_o$ .

**Solution:** For oxygen, from Table A.4, take  $k = 1.40$  and  $R = 260 \text{ J/kg}\cdot\text{K}$ . Compute the specific heat:  $c_p = kR/(k - 1) = 1.4(260)/(1.4 - 1) = 910 \text{ J/kg}\cdot\text{K}$ . Use energy and mass together:

$$T + \frac{V^2}{2c_p} = T_o, \quad \text{or:} \quad T + \frac{V^2}{2(910 \text{ m}^2/\text{s}^2\text{K})} = 573 \text{ K}$$

$$\dot{m} = \rho AV = \frac{p}{RT} AV = \left[ \frac{120000 \text{ Pa}}{(260 \text{ m}^2/\text{s}^2\text{K})T} \right] \left( \frac{\pi}{4} \right) (0.05 \text{ m})^2 V = 0.4 \text{ kg/s}$$

$$\text{Solve for} \quad T = 542 \text{ K} \quad \text{and} \quad \mathbf{V = 239 \text{ m/s}} \quad \text{Ans. (a)}$$

With  $T$  and  $V$  known, we can easily find the Mach number and stagnation density:

$$\text{Ma} = \frac{V}{\sqrt{kRT}} = \frac{239}{\sqrt{1.4(260)(542)}} = \frac{239 \text{ m/s}}{444 \text{ m/s}} = \mathbf{0.538} \quad \text{Ans. (b)}$$

$$\rho = \frac{p}{RT} = \frac{120000}{260(542)} = 0.852 \frac{\text{kg}}{\text{m}^3}$$

$$\rho_o = \rho \left( 1 + \frac{k-1}{2} \text{Ma}^2 \right)^{1/(k-1)} = 0.852 \left[ 1 + \frac{0.4}{2} (0.538)^2 \right]^{1/0.4} = \mathbf{0.98} \frac{\text{kg}}{\text{m}^3} \quad \text{Ans. (c)}$$

**9.31** Air flows adiabatically through a duct. At one section,  $V_1 = 400$  ft/s,  $T_1 = 200^\circ\text{F}$ , and  $p_1 = 35$  psia, while farther downstream  $V_2 = 1100$  ft/s and  $p_2 = 18$  psia. Compute (a)  $\text{Ma}_2$ ; (b)  $U_{\max}$ ; and (c)  $p_{o2}/p_{o1}$ .

**Solution:** (a) Begin by computing the stagnation temperature, which is constant (adiabatic):

$$T_{o1} = T_{o2} = T_1 + \frac{V^2}{2c_p} = (200 + 460) + \frac{(400)^2}{2(6010)} = 673^\circ\text{R} = T_2 + \frac{V^2}{2c_p}$$

$$\text{Then } T_2 = 673 - \frac{(1100)^2}{2(6010)} = 573^\circ\text{R},$$

$$\text{Ma}_2 = \frac{V_2}{a_2} = \frac{1100}{\sqrt{1.4(1717)(573)}} = \frac{1100}{1173} \approx \mathbf{0.938} \quad \text{Ans. (a)}$$

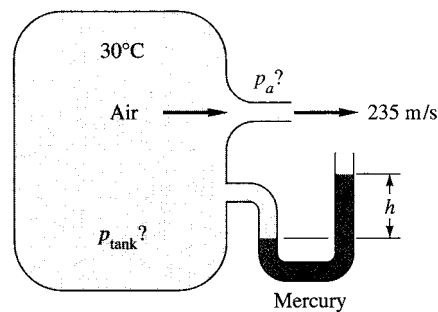
$$(b) \quad U_{\max} = \sqrt{2c_p T_o} = \sqrt{2(6010)(673)} \approx \mathbf{2840 \text{ ft/s}} \quad \text{Ans. (b)}$$

$$(c) \quad \text{We need } \text{Ma}_1 = V_1/a_1 = 400/\sqrt{1.4(1717)(200 + 460)} = 400/1260 \approx 0.318$$

$$\text{then } p_{o1} = p_1 (1 + 0.2\text{Ma}_1^2)^{3.5} = 1.072p_1 = 37.53 \text{ psia}$$

$$\text{and } p_{o2} = p_2 (1 + 0.2\text{Ma}_2^2)^{3.5} = 1.763p_2 = 31.74 \text{ psia}, \quad \therefore \frac{p_{o2}}{p_{o1}} = \frac{31.74}{37.53} \approx \mathbf{0.846} \quad \text{Ans. (c)}$$

**9.32** The large compressed-air tank in Fig. P9.32 exhausts from a nozzle at an exit velocity of 235 m/s. The mercury manometer reads  $h = 30$  cm. Assuming isentropic flow, compute the pressure (a) in the tank and (b) in the atmosphere. (c) What is the exit Mach number?



**Fig. P9.32**

**Solution:** The tank temperature =  $T_o = 30^\circ\text{C} = 303$  K. Then the exit jet temperature is

$$T_e = T_o - \frac{V_e^2}{2c_p} = 303 - \frac{(235)^2}{2(1005)} = 276 \text{ K}, \quad \therefore \text{Ma}_e = \frac{235}{\sqrt{1.4(287)(276)}} \approx \mathbf{0.706} \quad \text{Ans. (c)}$$

$$\text{Then } \frac{p_{\text{tank}}}{p_e} = (1 + 0.2\text{Ma}_e^2)^{3.5} = \mathbf{1.395} \quad \text{and} \quad p_{\text{tank}} - p_e = (\rho_{\text{mercury}} - \rho_{\text{tank}})gh$$

$$\text{Guess } \rho_{\text{tank}} \approx 1.6 \text{ kg/m}^3, \quad \therefore p_o - p_e \approx (13550 - 1.6)(9.81)(0.30) \approx \mathbf{39900 \text{ Pa}}$$

Solve the above two simultaneously for  $p_e \approx \mathbf{101 \text{ kPa}}$  and  $p_{\text{tank}} \approx \mathbf{140.8 \text{ kPa}}$  *Ans. (a, b)*

**9.33** Air flows isentropically from a reservoir, where  $p = 300$  kPa and  $T = 500$  K, to section 1 in a duct, where  $A_1 = 0.2$  m<sup>2</sup> and  $V_1 = 550$  m/s. Compute (a)  $Ma_1$ ; (b)  $T_1$ ; (c)  $p_1$ ; (d)  $\dot{m}$ ; and (e)  $A^*$ . Is the flow choked?

**Solution:** Use the energy equation to calculate  $T_1$  and then get the Mach number:

$$T_1 = T_o - \frac{V_1^2}{2c_p} = 500 - \frac{(550)^2}{2(1005)} = \mathbf{350 \text{ K}} \quad \text{Ans. (b)}$$

$$\text{Then } a_1 = \sqrt{1.4(287)(350)} = 375 \text{ m/s}, \quad Ma_1 = V_1/a_1 = \frac{550}{375} \approx \mathbf{1.47} \quad \text{Ans. (a)}$$

The flow **must be choked** in order to produce supersonic flow in the duct. *Answer.*

$$p_1 = p_o / (1 + 0.2 Ma_1^2)^{3.5} = 300 / [1 + 0.2(1.47)^2]^{3.5} \approx \mathbf{86 \text{ kPa}} \quad \text{Ans. (c)}$$

$$\rho_1 = \frac{p_1}{RT_1} = \frac{86000}{287(350)} \approx 0.854 \frac{\text{kg}}{\text{m}^3}, \quad \therefore \dot{m} = \rho AV = (0.854)(0.2)(550) \approx \mathbf{94 \frac{\text{kg}}{\text{s}}} \quad \text{Ans. (d)}$$

$$\text{Finally, } \frac{A}{A^*} = \frac{1}{Ma} \frac{(1 + 0.2Ma^2)^3}{1.728} = 1.155 \quad \text{if } Ma = 1.47,$$

$$\therefore A^* = \frac{0.2}{1.155} \approx \mathbf{0.173 \text{ m}^2} \quad \text{Ans. (e)}$$

**9.34** Steam in a tank at 450°F and 100 psia exhausts through a converging nozzle of throat area 0.1-in<sup>2</sup> to a 1-atm environment. Compute the initial mass flow rate (a) for an ideal gas; and (b) from the Steam Tables.

**Solution:** For steam, from Table A.4, let  $R = 461$  J/kg·K and  $k = 1.33$ . Then the critical pressure ratio is

$$\frac{p_o}{p^*} = \left[ 1 + \frac{0.33}{2} \right]^{1.33/0.33} = 1.85, \quad \text{hence } p_{\text{exit}} = p^* = \frac{100}{1.85} = 54.04 \text{ psia}$$

The nozzle is **choked** and exits at a pressure higher than 1 atm. Use Eq. 9.46 for  $k = 1.33$ :

$$\dot{m}_{\text{max}} = k^{1/2} \left( \frac{2}{k+1} \right)^{(k+1)/2(k-1)} \frac{p_o A^*}{\sqrt{RT_o}} = 0.6726 \frac{(100 \times 144)(0.1/144)}{\sqrt{2759(450 + 460)}} \approx \mathbf{0.00424 \frac{\text{slug}}{\text{s}}}$$

*Ans. (a) Ideal*

(b) For non-ideal (Steam Table) calculations, we first establish the stagnation entropy: at  $T_o = 450^\circ\text{F}$  and  $p_o = 100$  psia, read  $s_o = 1.6814$  Btu/lbm $^\circ\text{F}$  and  $h_o = 1253.7$  Btu/lbm. We need to guess the exit pressure  $p^* \approx 54$  psia from part (a), otherwise we will be here all month iterating in the Steam Tables, especially for the speed of sound. Then

$$\text{at } 54 \text{ psia and } s = 1.6814 \frac{\text{Btu}}{\text{lbm}\cdot^\circ\text{F}}, \text{ read } T \approx 328^\circ\text{F}, h \approx 1197.8 \frac{\text{Btu}}{\text{lbm}}, \text{ and } v = 8.443 \frac{\text{ft}^3}{\text{lbm}}$$

$$\text{Energy equation: } h_o = h + V^2/2, \text{ or } V = \sqrt{2(1253.7 - 1197.8)(778)(32.2)} \approx \mathbf{1673 \text{ ft/s}}$$

$$\text{We also need } \rho = 1/v = \frac{1}{8.443(32.2)} \approx \mathbf{0.00368 \text{ slug/ft}^3}$$

To determine if the exit flow is *sonic*, evaluate the “isentropic exponent” in the Tables:

$$\text{at } 328^\circ\text{F and } 54 \text{ psia, read } \gamma_{\text{isen}} \approx 1.31, \text{ then } a = \sqrt{\gamma p / \rho} = \sqrt{1.31(54 \times 144) / (0.00368)}$$

or  $a \approx \mathbf{1664 \text{ ft/s}}$ . This is close enough to  $V = 1673$  ft/s, don't iterate any more!

$$\text{Then } \dot{m}_{\text{tables}} = \rho AV = (0.00368)(0.1/144)(1670) \approx \mathbf{0.00427 \frac{\text{slug}}{\text{s}}} \quad \text{Ans. (b) non-ideal}$$

Even though we expand to *very near the saturation line*, the ideal-gas theory predicts the mass flow and exit pressure to within 1% and the exit temperature to within 2%.

**9.35** Helium, at  $T_o = 400$  K, enters a nozzle isentropically. At section 1, where  $A_1 = 0.1 \text{ m}^2$ , a pitot-static arrangement (see Fig. P9.25) measures stagnation pressure of 150 kPa and static pressure of 123 kPa. Estimate (a)  $Ma_1$ ; (b) mass flow; (c)  $T_1$ ; and (d)  $A^*$ .

**Solution:** For helium, from Table A.4, take  $k = 1.66$  and  $R = 2077$  J/kg $\cdot$ K. (a) The local pressure ratio is given, hence we can estimate the Mach number:

$$\frac{p_o}{p_1} = \frac{150}{123} = \left[ 1 + \frac{1.66 - 1}{2} Ma_1^2 \right]^{1.66 / (1.66 - 1)}, \text{ solve for } \mathbf{Ma_1 \approx 0.50} \quad \text{Ans. (a)}$$

Use this Mach number to estimate local temperature, density, velocity, and mass flow:

$$T_1 = \frac{T_o}{1 + (k - 1)Ma_1^2/2} = \frac{400}{1 + 0.33(0.50)^2} \approx \mathbf{370 \text{ K}} \quad \text{Ans. (c)}$$

$$\rho_1 = \frac{p_1}{RT_1} = \frac{123000}{2077(370)} \approx 0.160 \frac{\text{kg}}{\text{m}^3}$$

$$V_1 = Ma_1 a_1 = 0.50 [1.66(2077)(370)]^{1/2} \approx \mathbf{565 \frac{m}{s}}$$

$$\text{Finally, } \dot{m} = \rho_1 A_1 V_1 = (0.160)(0.1)(565) \approx \mathbf{9.03} \frac{\text{kg}}{\text{s}} \quad \text{Ans. (b)}$$

Finally,  $A^*$  can be computed from Eq. (9.44), using  $k = 1.66$ :

$$\frac{A_1}{A^*} = \frac{1}{Ma_1} \left[ \frac{1 + 0.33 Ma_1^2}{(1.66 + 1)/2} \right]^{(1/2)(2.66)/(0.66)} \approx 1.323, \quad A^* \approx \mathbf{0.0756 \text{ m}^2} \quad \text{Ans. (d)}$$

**9.36** An air tank of volume  $1.5 \text{ m}^3$  is at  $800 \text{ kPa}$  and  $20^\circ\text{C}$  when it begins exhausting through a converging nozzle to sea-level conditions. The throat area is  $0.75 \text{ cm}^2$ . Estimate (a) the initial mass flow; (b) the time to blow down to  $500 \text{ kPa}$ ; and (c) the time when the nozzle ceases being choked.

**Solution:** For sea level,  $p_{\text{ambient}} = 101.35 \text{ kPa} < 0.528 p_{\text{tank}}$ , hence the flow is choked until the tank pressure drops to  $p_{\text{ambient}}/0.528 = 192 \text{ kPa}$ . (a) We obtain

$$\dot{m}_{\text{initial}} = \dot{m}_{\text{max}} = 0.6847 \frac{p_o A^*}{\sqrt{RT_o}} = 0.6847 \frac{800000(0.75E-4 \text{ m}^2)}{\sqrt{287(293)}} = \mathbf{0.142} \frac{\text{kg}}{\text{s}} \quad \text{Ans. (a)}$$

(b) For a control volume surrounding the tank, a mass balance gives

$$\frac{d}{dt}(\rho_o v) = \frac{v}{RT_o} \frac{dp_o}{dt} = -\dot{m} = -0.6847 \frac{p_o A^*}{\sqrt{RT_o}}, \quad \text{separate the variables:}$$

$$\frac{p(t)}{p(0)} = \exp \left[ -0.6847 \frac{A^* \sqrt{RT_o}}{v} t \right] = e^{-0.00993t} \quad \text{until } p(t) \text{ drops to } 192 \text{ kPa}$$

At  $500 \text{ kPa}$ , we obtain  $500/800 = \exp(-0.00993t)$ , or  $t \approx \mathbf{47 \text{ s}}$  Ans. (b)

At choking ( $192 \text{ kPa}$ ),  $192/800 = \exp(-0.00993t)$ , or  $t \approx \mathbf{144 \text{ s}}$  Ans. (c)

**9.37** Make an exact control volume analysis of the blowdown process in Fig. P9.37, assuming an insulated tank with negligible kinetic and potential energy. Assume critical flow at the exit and show that both  $p_o$  and  $T_o$  decrease during blowdown. Set up first-order differential equations for  $p_o(t)$  and  $T_o(t)$  and reduce and solve as far as you can.

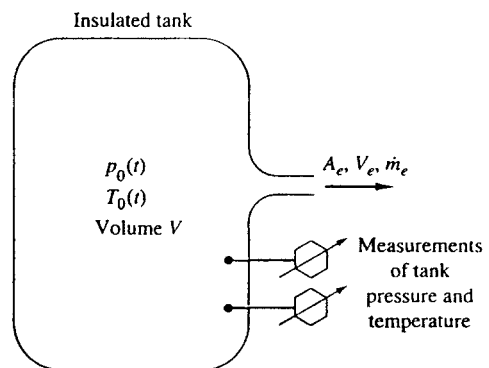


Fig. P9.37

**Solution:** For a CV around the tank, write the mass and the energy equations:

$$\text{mass: } \frac{d}{dt}(\rho_o v) = -\dot{m}, \quad \text{or} \quad \frac{d}{dt}\left(\frac{p_o}{RT_o} v\right) = -B \frac{p_o}{\sqrt{T_o}}, \quad \text{where } B = \frac{0.6847A^*}{\sqrt{R}}$$

$$\text{energy: } \frac{dQ}{dt} + \frac{dW}{dt} = 0 = \frac{d}{dt}\left(\frac{p_o}{RT_o} v c_v T_o\right) + \dot{m} c_p T_o$$

We may rearrange and combine these to give a single differential equation for  $T_o$ :

$$\frac{dT_o}{dt} = -CT_o^{3/2}, \quad \text{where } C = \frac{0.6847}{v}(k-1)A^*\sqrt{R}, \quad \text{or} \quad \int \frac{dT_o}{T_o^{3/2}} = -C \int dt$$

$$\text{Integrate: } T_o(t) = \left[ \frac{1}{\sqrt{T_o(0)}} + \frac{1}{2} Ct \right]^{-2} \quad \text{Ans.}$$

With  $T_o(t)$  known, we could go back and solve the mass relation for  $p_o(t)$ , but in fact that is not necessary. We simply use the isentropic-flow assumption:

$$\frac{p_o(t)}{p_o(0)} = \left[ \frac{T_o(t)}{T_o(0)} \right]^{k/(k-1)} = \left[ 1 + \frac{1}{2} CT_o^{1/2}(0)t \right]^{-2k/(k-1)} \left( C = \frac{0.6847(k-1)A^*\sqrt{R}}{v} \right) \quad \text{Ans.}$$

Clearly, tank pressure also decreases with time as the tank blows down.

**9.38** Prob. 9.37 makes an ideal senior project or combined laboratory and computer problem, as described in Ref. 30, sec. 8.6. In Bober and Kenyon's lab experiment, the tank had a volume of  $0.0352 \text{ ft}^3$  and was initially filled with air at  $50 \text{ lb/in}^2$  gage and  $72^\circ\text{F}$ . Atmospheric pressure was  $14.5 \text{ lb/in}^2$  absolute, and the nozzle exit diameter was  $0.05 \text{ in}$ . After  $2 \text{ s}$  of blowdown, the measured tank pressure was  $20 \text{ lb/in}^2$  gage and the tank temperature was  $-5^\circ\text{F}$ . Compare these values with the theoretical analysis of Prob. 9.37.

**Solution:** Use the formulas derived in Prob. 9.37 above, with the given data:

$$T_o(0) = 72 + 460 = 532^\circ\text{R},$$

$$\text{"C"} = \frac{0.6847(\pi/4)(0.05/12)^2(1.4-1)\sqrt{1717}}{0.0352 \text{ ft}^3} \approx 0.0044 \frac{1}{\text{s} \cdot \text{R}^{1/2}}$$

$$\text{Then } T_o(t) \approx T_o(0) \left[ 1 + \frac{1}{2}(0.0044)\sqrt{532}t \right]^{-2} = 532/[1 + 0.0507t]^2$$

$$\text{Similarly, } p_o = p_o(0)[T_o/T_o(0)]^{k/(k-1)} = (50 + 14.5 \text{ psia})/[1 + 0.0507t]^7$$

Some numerical predictions from these two formulas are as follows:

t, sec:	0	0.5	1.0	1.5	2.0
T <sub>o</sub> , °R:	532.0	506.0	481.9	459.5	<b>438.6°R</b>
p <sub>o</sub> , psia:	64.5	54.1	45.6	38.6	<b>32.8 psia</b>

At t = 2 sec, the tank temperature is 438.6°R = **-21.4°F**, compared to -5°F measured.

At t = 2 sec, the tank pressure is 32.8 psia = **18.3 psig**, compared to 20 psig measured.

The discrepancy is probably due to heat transfer through the tank walls warming the air.

**9.39** Consider isentropic flow in a channel of varying area, between sections 1 and 2. Given Ma<sub>1</sub> = 2.0, we desire that V<sub>2</sub>/V<sub>1</sub> equal 1.2. Estimate (a) Ma<sub>2</sub> and (b) A<sub>2</sub>/A<sub>1</sub>. (c) Sketch what this channel looks like, for example, does it converge or diverge? Is there a throat?

**Solution:** This is a problem in iteration, ideally suited for EES. Algebraically,

$$\frac{V_2}{V_1} = \frac{Ma_2 a_2}{Ma_1 a_1} = \frac{Ma_2}{Ma_1} \frac{a_o \left[1 + 0.2 Ma_2^2\right]^{-1/2}}{a_o \left[1 + 0.2 Ma_1^2\right]^{-1/2}} = 1.2, \quad \text{given that } Ma_1 = 2.0$$

For adiabatic flow, a<sub>o</sub> is constant and cancels. Introducing Ma<sub>1</sub> = 2.0, we have to solve Ma<sub>2</sub>/[1 + 0.2Ma<sub>2</sub><sup>2</sup>]<sup>1/2</sup> ≈ 1.789. By iteration, the solution is: **Ma<sub>2</sub> = 2.98** Ans. (a)

$$\text{Then } \frac{A_2}{A_1} = \frac{A_2/A^*}{A_1/A^*} = \frac{4.1547}{1.6875} \text{ (Table B.1)} \approx \mathbf{2.46} \quad \text{Ans. (b)}$$

There is no throat, it is a **supersonic expansion**. Ans. (c) 

**9.40** Air, with stagnation conditions of 800 kPa and 100°C, expands isentropically to a section of a duct where A<sub>1</sub> = 20 cm<sup>2</sup> and p<sub>1</sub> = 47 kPa. Compute (a) Ma<sub>1</sub>; (b) the throat area; and (c) ṁ. At section 2, between the throat and section 1, the area is 9 cm<sup>2</sup>. (d) Estimate the Mach number at section 2.

**Solution:** Use the downstream pressure to compute the Mach number:

$$\frac{p_o}{p_1} = \frac{800}{47} = \left(1 + 0.2 Ma_1^2\right)^{3.5}, \quad \text{solve } \mathbf{Ma_1 \approx 2.50} \quad \text{Ans. (a)}$$

$$\text{Flow is choked: } \frac{A_1}{A^*} = \frac{20}{A^*} = \frac{1}{Ma_1} \frac{\left(1 + 0.2 Ma_1^2\right)^3}{1.728} = 2.63,$$

$$\therefore A^* = \frac{20}{2.63} \approx \mathbf{7.6 \text{ cm}^2} \quad \text{Ans. (b)}$$

$$\dot{m} = \dot{m}_{\max} = 0.6847 \frac{p_o A^*}{\sqrt{RT_o}} = 0.6847 \frac{800000(7.6E-4)}{\sqrt{287(373)}} \approx \mathbf{1.27 \text{ kg/s}} \quad \text{Ans. (c)}$$

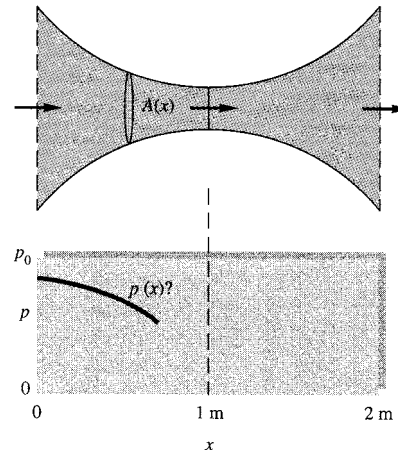
$$\text{Finally, at } A_2 = 9 \text{ cm}^2, \quad \frac{A_2}{A^*} = \frac{9.0}{7.6} \Big|_{\text{supersonic}} = \frac{1}{\text{Ma}_2} \frac{(1 + 0.2 \text{Ma}_2^2)^3}{1.728},$$

$$\text{solve } \mathbf{Ma}_2 \approx \mathbf{1.50} \quad \text{Ans. (d)}$$

**9.41** Air, with a stagnation pressure of 100 kPa, flows through the nozzle in Fig. P9.41, which is 2 m long and has an area variation approximated by

$$A \approx 20 - 20x + 10x^2$$

with  $A$  in  $\text{cm}^2$  and  $x$  in m. It is desired to plot the complete family of isentropic pressures  $p(x)$  in this nozzle, for the range of inlet pressures  $1 < p(0) < 100$  kPa. Indicate those inlet pressures which are not physically possible and discuss briefly. If your computer has an online graphics routine, plot at least 15 pressure profiles; otherwise just hit the highlights and explain.



**Fig. P9.41**

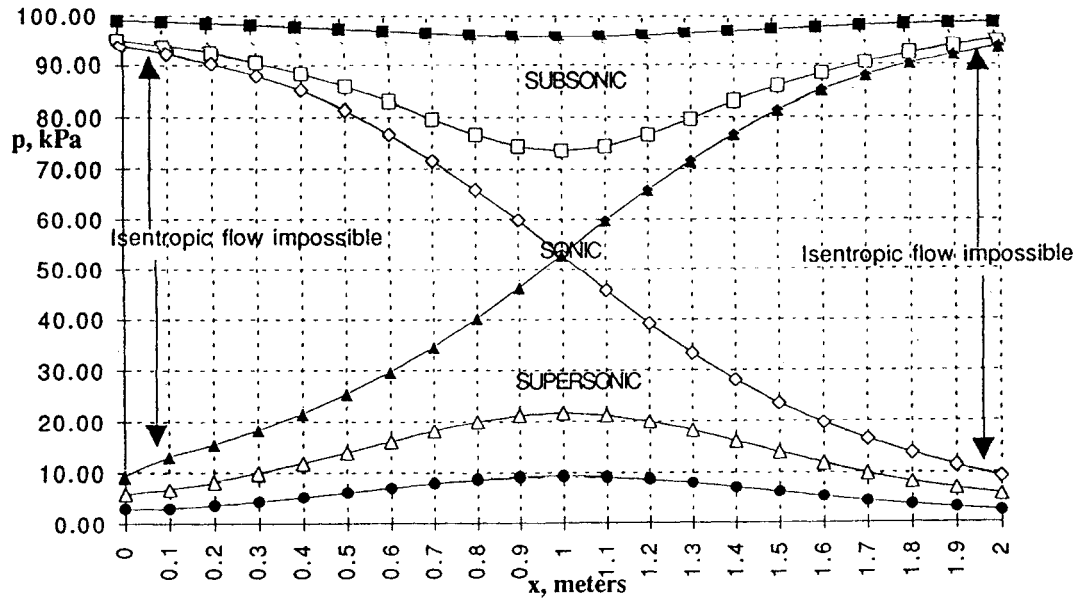
**Solution:** There is a subsonic entrance region of high pressure and a supersonic entrance region of low pressure, both of which are bounded by a sonic (critical) throat, and both of which have a ratio  $A_{x=0}/A^* = 2.0$ . From Table B.1 or Eq. (9.44), we find these two conditions to be bounded by

a) subsonic entrance:  $A/A^* = 2.0$ ,  $\text{Ma}_e \approx 0.306$ ,  $p_e \approx 0.9371p_o \approx \mathbf{93.71 \text{ kPa}}$

b) supersonic entrance:  $A/A^* = 2.0$ ,  $\text{Ma}_e \approx 2.197$ ,  $p_e \approx 0.09396p_o \approx \mathbf{9.396 \text{ kPa}}$

Thus *no isentropic flow can exist* between entrance pressures  $9.396 < p_e < 93.71$  kPa. The complete family of isentropic pressure curves is shown in the graph on the following page. They are **not** easy to find, because we have to convert implicitly from area ratio to Mach number.





**9.42** A bicycle tire is filled with air at 169.12 kPa (abs) and 30°C. The valve breaks, and air exhausts into the atmosphere of 100 kPa (abs) and 20°C. The valve exit is 2-mm-diameter and is the smallest area in the system. Assuming one-dimensional isentropic flow, (a) find the initial Mach number, velocity, and temperature at the exit plane. (b) Find the initial mass flow rate. (c) Estimate the exit velocity using the *incompressible Bernoulli equation*. How well does this estimate agree with part (a)?

**Solution:** (a) Flow is *not* choked, because the pressure ratio is less than 1.89:

$$\frac{p_o}{p} = \frac{169.12}{100} = (1 + 0.2Ma_e^2)^{3.5}, \quad \text{solve } \mathbf{Ma_e = 0.90}; \quad \text{Read } T_e = 0.8606T_o = \mathbf{261 \text{ K}}$$

$$V_e = Ma_e a_e = (0.90)\sqrt{1.4(287)(261)} = 0.90(324) = \mathbf{291 \frac{m}{s}} \quad \text{Ans. (a)}$$

(b) Evaluate the exit density at  $Ma = 0.90$  and thence the mass flow:

$$\rho_e = \frac{p_e}{RT_e} = \frac{100000}{287(261)} = 1.335 \frac{\text{kg}}{\text{m}^3},$$

$$\text{Then } \dot{m} = \rho_e A_e V_e = (1.335) \frac{\pi}{4} (0.002)^2 (291) = \mathbf{0.00122 \frac{kg}{s}} \quad \text{Ans. (b)}$$

(c) Assume  $\rho = \rho_o = \rho_{\text{tire}}$ , for how would we know  $\rho_{\text{exit}}$  if we didn't use compressible-flow theory? Then the incompressible Bernoulli relation predicts

$$\rho_o = \frac{p_o}{RT_o} = \frac{169120}{287(303)} = 1.945 \frac{\text{kg}}{\text{m}^3}$$

$$V_{e,\text{inc}} \approx \sqrt{\frac{2\Delta p}{\rho_o}} = \sqrt{\frac{2(169120 - 100000)}{1.945}} \approx \mathbf{267 \frac{m}{s}} \quad \text{Ans. (c)}$$

This is **8% lower** than the “exact” estimate in part (a).

**9.43** Air flows isentropically through a duct with  $T_o = 300^\circ\text{C}$ . At two sections with identical areas of  $25 \text{ cm}^2$ , the pressures are  $p_1 = 120 \text{ kPa}$  and  $p_2 = 60 \text{ kPa}$ . Determine (a) the mass flow; (b) the throat area, and (c)  $\text{Ma}_2$ .

**Solution:** If the areas are the same and the pressures *different*, than section (1) must be subsonic and section (2) supersonic. In other words, we need to find where

$$\frac{p_1/p_o}{p_2/p_o} = \frac{120}{60} = 2.0 \quad \text{for the same } A_1/A^* = A_2/A^* \text{—search Table B.1 (isentropic)}$$

After laborious but straightforward iteration,  $\text{Ma}_1 = 0.729$ ,  $\mathbf{\text{Ma}_2 \approx 1.32}$  Ans. (c)

$$A/A^* = 1.075 \text{ for both sections, } A^* = 25/1.075 = \mathbf{23.3 \text{ cm}^2} \quad \text{Ans. (b)}$$

With critical area and stagnation conditions known, we may compute the mass flow:

$$p_o = 120[1 + 0.2(0.729)^2]^{3.5} \approx 171 \text{ kPa} \quad \text{and} \quad T_o = 300 + 273 = 573 \text{ K}$$

$$\dot{m} = 0.6847 p_o A^* / [RT_o]^{1/2} = 0.6847(171000)(0.00233) / [287(573)]^{1/2}$$

$$\dot{m} \approx \mathbf{0.671 \frac{kg}{s}} \quad \text{Ans. (a)}$$

**9.44** In Prob. 3.34 we knew nothing about compressible flow at the time so merely assumed exit conditions  $p_2$  and  $T_2$  and computed  $V_2$  as an application of the continuity equation. Suppose

that the throat diameter is 3 in. For the given stagnation conditions in the rocket chamber in Fig. P3.34 and assuming  $k = 1.4$  and a molecular weight of 26, compute the actual exit velocity, pressure, and temperature according to one-dimensional theory. If  $p_a = 14.7 \text{ lbf/in}^2$  absolute, compute the thrust from the analysis of Prob. 3.68. This thrust is entirely independent of the stagnation temperature (check this by changing  $T_o$  to  $2000^\circ\text{R}$  if you like). Why?

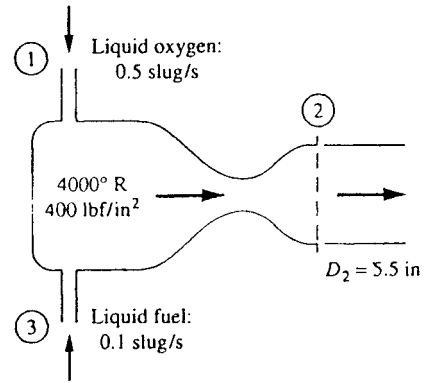


Fig. P3.34

**Solution:** If  $M = 26$ , then  $R_{\text{gas}} = 49720/26 = 1912 \text{ ft}\cdot\text{lbf}/\text{slug}\cdot^\circ\text{R}$ . Assuming choked flow in the throat (to produce a supersonic exit), the exit area ratio yields the exit Mach number:

$$\frac{A_e}{A^*} = \left(\frac{D_e}{D^*}\right)^2 = \left(\frac{5.5}{3.0}\right)^2 = 3.361, \text{ whence Eq. 9.45 (for } k = 1.4) \text{ predicts } \text{Ma}_e \approx \mathbf{2.757}$$

$$\text{Then isentropic } p_e = 400/[1 + 0.2(2.757)^2]^{3.5} \approx \mathbf{15.7 \text{ psia}} \quad \text{Ans.}$$

$$T_e = 4000^\circ\text{R}/[1 + 0.2(2.757)^2] \approx \mathbf{1587^\circ\text{R}} \quad \text{Ans.}$$

$$\text{Then } V_e = \text{Ma}_e \sqrt{kRT_e} = 2.757 \sqrt{1.4(1912)(1587)} \approx \mathbf{5680 \text{ ft/s}} \quad \text{Ans.}$$

$$\text{We also need } \rho_e = p_e/RT_e = (15.7 \times 144)/[1912(1587)] \approx 0.000747 \text{ slug}/\text{ft}^3$$

$$\text{From Prob. 3.68, Thrust } F = A_e [\rho_e V_e^2 + (p_e - p_a)],$$

$$\text{or: } F = \frac{\pi}{4} \left(\frac{5.5}{12}\right)^2 [0.000747(5680)^2 + (15.7 - 14.7) \times 144] \approx \mathbf{4000 \text{ lbf}} \quad \text{Ans.}$$

Thrust is independent of  $T_o$  because  $\rho_e \propto 1/T_o$  and  $V_e \propto \sqrt{T_o}$ , so  $T_o$  cancels out.

**9.45** At a point upstream of the throat of a converging-diverging nozzle, the properties are  $V_1 = 200 \text{ m/s}$ ,  $T_1 = 300 \text{ K}$ , and  $p_1 = 125 \text{ kPa}$ . If the exit flow is supersonic, compute, from isentropic theory, (a)  $\dot{m}$ ; and (b)  $A_1$ . The throat area is  $35 \text{ cm}^2$ .

**Solution:** We begin by computing the Mach number at section 1 for air:

$$a_1 = \sqrt{kRT_1} = \sqrt{1.4(287)(300)} = 347 \text{ m/s}, \quad \therefore \text{Ma}_1 = 200/347 \approx \mathbf{0.576}$$

Given that the exit flow is supersonic, we know that  $A^*$  is the *throat*. Then we find

$$\text{At } M_1 = 0.576, \quad A_1/A^* \approx 1.218, \quad \text{thus } A_1 = 1.218(35) \approx \mathbf{42.6 \text{ cm}^2} \quad \text{Ans. (b)}$$

$$\rho_1 = p_1/RT_1 = 125000/[287(300)] \approx 1.45 \text{ kg/m}^3$$

$$\text{Finally, } \dot{m} = \rho_1 A_1 V_1 = (1.45)(42.6E-4)(200) \approx \mathbf{1.24 \text{ kg/s}} \quad \text{Ans. (a)}$$

**9.46** If the writer did not falter, the results of Prob. 9.43 are (a) 0.671 kg/s, (b) 23.3 cm<sup>2</sup>, and (c) 1.32. Do not tell your friends who are still working on Prob. 9.43. Consider a control volume which encloses the nozzle between these two 25-cm<sup>2</sup> sections. If the pressure outside the duct is 1 atm, determine the total force acting on this section of nozzle.

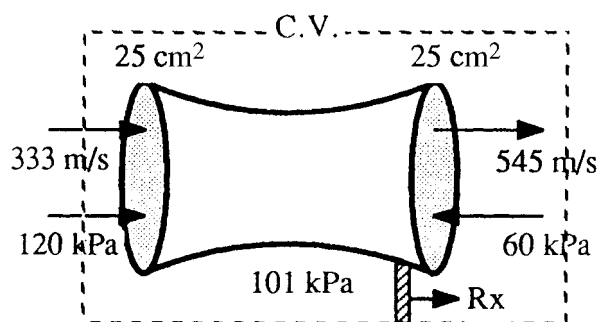


Fig. P9.46

**Solution:** The control volume encloses this portion of duct as in the figure above. To complete the analysis, we need the velocities at sections 1 and 2:

$$Ma_1 = 0.729, \quad T_0 = 573 \text{ K}, \quad T_1 = T_0 / (1 + 0.2Ma_1^2) = 518 \text{ K}, \quad a_1 = 456 \frac{\text{m}}{\text{s}},$$

$$V_1 = Ma_1 a_1 = 0.729(456) = \mathbf{333 \text{ m/s}}; \quad \text{similarly, } Ma_2 = 1.32 \text{ leads to } V_2 = \mathbf{545 \text{ m/s}}$$

Then the control-volume x-momentum relation yields, for steady flow,

$$\sum F_x = R_x + (p_1 - p_2)_{\text{gage}} A_1 = \dot{m}(V_2 - V_1),$$

$$\text{or: } R_x = (0.671)(545 - 333) + (-120000 + 60000)(0.0025) = 142 - 150 = \mathbf{-8 \text{ N}} \quad \text{Ans.}$$

Things are pretty well balanced, and there is a small 8-N support force  $R_x$  to the *left*.

**9.47** In wind-tunnel testing near Mach 1, a small area decrease caused by model blockage can be important. Let the test section area be 1 sq.m. and unblocked conditions are  $Ma = 1.1$  and  $T = 20^\circ\text{C}$ . What model area will first cause the test section to choke? If the model cross-section is 0.004 sq.m., what % change in test-section velocity results?

**Solution:** First evaluate the unblocked test conditions:

$$T = 293^\circ\text{K}, \quad a = \sqrt{kRT} = \sqrt{1.4(287)(293)} = 343 \frac{\text{m}}{\text{s}}, \quad \therefore V = (1.1)(343) = 377 \frac{\text{m}}{\text{s}}$$

$$\text{Also, } \frac{A}{A^*} = \frac{[1 + 0.2(1.1)^2]^3}{1.728(1.1)} = 1.007925, \quad \text{or } A^* = 1.0/1.007925 \approx \mathbf{0.99214 \text{ m}^2}$$

(unblocked)

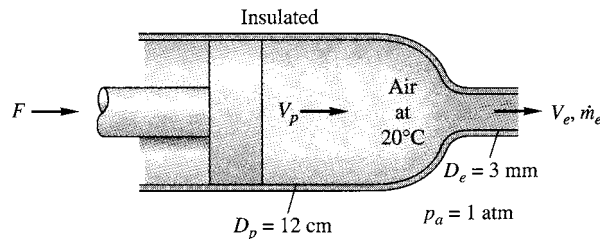
If  $A$  is blocked by  $0.004 \text{ m}^2$ , then  $A_{\text{new}} = 1.0 - 0.004 = 0.996 \text{ m}^2$ , and now

$$\frac{A_{\text{new}}}{A^*} = \frac{0.996}{0.99214} = 1.00389, \quad \text{solve Eq. (9.45) for } \text{Ma}(\text{blocked}) \approx \mathbf{1.0696}$$

$$\text{Same } T_o = 364 \text{ K, new } T = 296 \text{ K, new } a = 345 \text{ m/s, new } V = \text{Ma}(a) \approx \mathbf{369 \frac{m}{s}} \quad \text{Ans.}$$

Thus a 0.4% decrease in test section area has caused a 2.1% decrease in test velocity.

**9.48** A force  $F = 1100 \text{ N}$  pushes a piston of diameter  $12 \text{ cm}$  through an insulated cylinder containing air at  $20^\circ\text{C}$ , as in Fig. P9.48. The exit diameter is  $3 \text{ mm}$ , and  $p_a = 1 \text{ atm}$ . Estimate (a)  $V_e$ , (b)  $V_p$ , and (c)  $\dot{m}_e$ .



**Fig. P9.48**

**Solution:** First find the pressure inside the large cylinder:

$$p_p = \frac{F}{A} + 1 \text{ atm} = \frac{1100}{(\pi/4)(0.12)^2} + 101350 \approx 198600 = 1.96 \text{ atm}$$

Since this is greater than  $(1/0.5283) \text{ atm}$ , the small cylinder is **choked**, and thus

$$V_{\text{exit}} = \sqrt{\frac{2k}{k+1} RT_o} = \sqrt{\frac{2(1.4)}{1.4+1} (287)(293)} \approx \mathbf{313 \text{ m/s}} \quad \text{Ans. (a)}$$

$$V_{\text{piston}} = (\rho_e/\rho_p)(A_e/A_p)V_e = (0.6339)(0.003/0.12)^2(313) = \mathbf{0.124 \text{ m/s}} \quad \text{Ans. (b)}$$

$$\text{Finally, } \dot{m} = \dot{m}_{\max} = 0.6847 \frac{(198600)(\pi/4)(0.003)^2}{\sqrt{287(293)}} \approx \mathbf{0.00331} \frac{\mathbf{kg}}{\mathbf{s}} \quad \text{Ans. (c)}$$

The mass flow increases with  $F$ , but the piston velocity and exit velocity are independent of  $F$  if the exit flow is choked.

**9.49** Consider the venturi nozzle of Fig. 6.40c, with  $D = 5$  cm and  $d = 3$  cm. Air stagnation temperature is 300 K, and the upstream velocity  $V_1 = 72$  m/s. If the throat pressure is 124 kPa, estimate, with isentropic flow theory, (a)  $p_1$ ; (b)  $Ma_2$ ; and (c) the mass flow.

**Solution:** Given one-dimensional isentropic flow of air. The problem looks sticky—sparse, scattered information, implying laborious iteration. But the energy equation yields  $V_1$  and  $Ma_1$ :

$$T_o = T_1 + \frac{V_1^2}{2c_p} = 300 \text{ K} = T_1 + \frac{(72 \text{ m/s})^2}{2(1005 \text{ J/kg}\cdot\text{K})}, \quad \text{solve for } T_1 = 297.4 \text{ K}$$

$$Ma_1 = \frac{V_1}{\sqrt{kRT_1}} = \frac{72}{\sqrt{1.4(287)(297.4)}} = \frac{72 \text{ m/s}}{346 \text{ m/s}} = 0.208$$

Area-ratio calculations will then yield  $A^*$  and  $Ma_2$  and then  $p_o$  and  $p_1$ :

$$\frac{A_1}{A^*} = \frac{(\pi/4)(0.05 \text{ m})^2}{A^*} = \frac{(1 + 0.2 Ma_1^2)^3}{1.728 Ma_1} = \frac{[1 + 0.2(0.208)^2]^3}{1.728(0.208)} = 2.85,$$

$$\text{Solve } A^* = 0.0006886 \text{ m}^2$$

$$\frac{A_2}{A^*} = \frac{(\pi/4)(0.03 \text{ m})^2}{0.0006886 \text{ m}^2} = \frac{(1 + 0.2 Ma_2^2)^3}{1.728 Ma_2} = 1.027, \quad \text{Solve } \mathbf{Ma_2 = 0.831} \quad \text{Ans. (b)}$$

$$p_o = p_2 (1 + 0.2 Ma_2^2)^{3.5} = (124 \text{ kPa}) [1 + 0.2(0.831)^2]^{3.5} = 195 \text{ kPa}$$

$$p_1 = p_o / (1 + 0.2 Ma_1^2)^{3.5} = (195 \text{ kPa}) / [1 + 0.2(0.208)^2]^{3.5} = \mathbf{189 \text{ kPa}} \quad \text{Ans. (a)}$$

The mass flow follows from any of several formulas. For example:

$$\dot{m} = \rho_1 A_1 V_1 = \left( \frac{p_1}{RT_1} \right) A_1 V_1 = \left[ \frac{189000}{287(297.4)} \right] \left( \frac{\pi}{4} \right) (0.05)^2 (72) = \mathbf{0.313} \frac{\mathbf{kg}}{\mathbf{s}} \quad \text{Ans. (c)}$$

**9.50** Argon expands isentropically at 1 kg/s in a converging nozzle with  $D_1 = 10$  cm,  $p_1 = 150$  kPa, and  $T_1 = 100^\circ\text{C}$ . The flow discharges to a pressure of 101 kPa. (a) What is the nozzle exit diameter? (b) How much further can the ambient pressure be reduced before it affects the inlet mass flow?

**Solution:** For argon, from Table A.4,  $R = 208$  J/kg·K and  $k = 1.67$ .

$$\rho_1 = \frac{150000}{208(373)} = 1.93 \frac{\text{kg}}{\text{m}^3}, \quad \dot{m} = 1 \frac{\text{kg}}{\text{s}} = 1.93 \frac{\pi}{4} (0.1)^2 V_1, \quad \therefore V_1 = 66 \frac{\text{m}}{\text{s}}$$

$$Ma_1 = \frac{66}{\sqrt{1.67(208)(373)}} = 0.183, \quad \frac{A_1}{A^*} = \frac{1}{0.183} \left[ \frac{1 + 0.335(0.183)^2}{(1 + 1.67)/2} \right]^{\frac{1.67+1}{2(1.67-1)}} = 3.14$$

Thus  $A^* = A_1/3.14 = 0.00250 \text{ m}^2 = (\pi/4)D_e^2$ , solve  $D_{\text{exit}} = \mathbf{0.0564 \text{ m}}$  Ans. (a)

$$p_o = 150[1 + 0.335(0.183)^2]^{\frac{1.67}{0.67}} = 154 \text{ kPa},$$

$$\frac{p_e}{p_o} = \frac{101}{154} = (1 + 0.335 Ma_e^2)^{\frac{-1.67}{0.67}}, \quad \mathbf{Ma_e = 0.743}$$

Thus the exit flow is *not* choked. We could decrease the ambient pressure to **75 kPa** before the flow would choke. The maximum mass flow is about 1.01 kg/s.

**9.51** Air, at stagnation conditions of 500 K and 200 kPa, flow through a nozzle. At section 1, where  $A = 12 \text{ cm}^2$ , the density is  $0.32 \text{ kg/m}^3$ . Assuming isentropic flow, (a) find the mass flow. (b) Is the flow choked? If so, estimate  $A^*$ . Also estimate (c)  $p_1$ ; and (d)  $Ma_1$ .

**Solution:** Evaluate stagnation density, density ratio, and Mach number:

$$\rho_o = \frac{p_o}{RT_o} = \frac{200000}{287(500)} = 1.39 \frac{\text{kg}}{\text{m}^3};$$

$$\frac{\rho_o}{\rho} = \frac{1.39}{0.32} = (1 + 0.2 Ma_1^2)^{2.5}, \quad \text{solve } \mathbf{Ma_1 = 2.00} \quad \text{Ans. (d)}$$

$$T_1 = 500/[1 + 0.2(2.00)^2] = 278 \text{ K}, \quad V_1 = Ma_1 a_1 = 2.00[1.4(287)(278)]^{1/2} = 668 \frac{\text{m}}{\text{s}}$$

$$\text{Finally, } \dot{m} = \rho_1 A_1 V_1 = 0.32(12E-4)(668) = \mathbf{0.257 \frac{\text{kg}}{\text{s}}} \quad \text{Ans. (a)}$$

The **flow is clearly choked**, because  $Ma_1$  is supersonic. A throat exists:

$$\dot{m} = 0.257 = \dot{m}_{max} = 0.6847 \frac{p_o A^*}{\sqrt{RT_o}} = 0.6847 \frac{200000 A^*}{\sqrt{287(500)}},$$

$$\text{solve } A^* = \mathbf{0.000710 \text{ m}^2} \quad \text{Ans. (b)}$$

(c) Also calculate

$$p_1 = \frac{p_o}{(1 + 0.2 Ma_1^2)^{3.5}} = \frac{200000}{[1 + 0.2(2.00)^2]^{3.5}} = 25500 \text{ Pa} \quad \text{Ans. (c)}$$

**9.52** A converging-diverging nozzle exits smoothly to sea-level standard atmosphere. It is supplied by a  $40\text{-m}^3$  tank initially at 800 kPa and  $100^\circ\text{C}$ . Assuming isentropic flow, estimate (a) the throat area; and (b) the tank pressure after 10 sec of operation. NOTE: The exit area is  $10 \text{ cm}^2$  (this was omitted in the first printing).

**Solution:** The phrase “exits smoothly” means that exit pressure = atmospheric pressure, which is 101 kPa. Then the pressure ratio specifies the exit Mach number:

$$p_o/p_{\text{exit}} = \frac{800}{101} = [1 + 0.2 Ma_e^2]^{3.5}, \quad \text{solve for } \mathbf{Ma_{\text{exit}} \approx 2.01}$$

$$\text{Thus } A_e/A^* = 1.695 \quad \text{and} \quad A^* = (10 \text{ cm}^2)/1.695 \approx \mathbf{5.9 \text{ cm}^2} \quad \text{Ans. (a)}$$

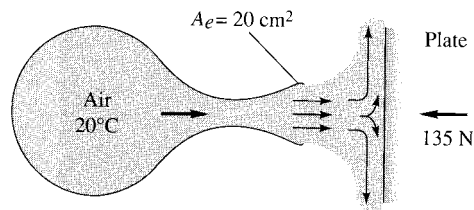
$$\text{Further, } \dot{m} = \dot{m}_{max} = 0.6847(800000)(0.00059)/\sqrt{287(373)} \approx 0.99 \text{ kg/s}$$

The initial mass in the tank is quite large because of large volume and high pressure:

$$\rho_o = \frac{p_o}{RT_o} = \frac{800000}{287(373)} \approx 7.47 \frac{\text{kg}}{\text{m}^3}, \quad \text{thus } m_{\text{tank}, t=0} = \rho v = (7.47)(40) \approx \mathbf{299 \text{ kg}}$$

After 10 sec, blowing down at 0.99 kg/s, we have about  $299 - 10 \approx 289 \text{ kg}$  left in the tank. The pressure will drop to about  $800(289/299) \approx \mathbf{773 \text{ kPa}}$ . Ans. (b).

**9.53** Air flows steadily from a reservoir at  $20^\circ\text{C}$  through a nozzle of exit area  $20 \text{ cm}^2$  and strikes a vertical plate as in Fig. P9.53. The flow is subsonic throughout. A force of 135 N is required to hold the plate stationary. Compute (a)  $V_e$ , (b)  $Ma_e$ , and (c)  $p_0$  if  $p_a = 101 \text{ kPa}$ .



**Fig. P9.53**



**Solution:** Assume  $p_e = 1$  atm. For a control volume surrounding the plate, we deduce that

$$F = 135 \text{ N} = \rho_e V_e^2 A_e = k p_e \text{Ma}_e^2 A_e = 1.4(101350)(0.002 \text{ m}^2) \text{Ma}_e^2,$$

or  **$\text{Ma}_e \approx 0.69$**  Ans. (b)

$$T_e = 293/[1 + 0.2(0.69)^2] \approx 268 \text{ K}, \quad a_e = \sqrt{1.4(287)(268)} = 328 \frac{\text{m}}{\text{s}}, \text{ thus}$$

$$V_e = a_e \text{Ma}_e = (328)(0.69) \approx \mathbf{226 \text{ m/s}} \quad \text{Ans. (a)}$$

$$\text{Finally, } p_{\text{tank}} = p_o = 101350[1 + 0.2(0.69)^2]^{3.5} \approx \mathbf{139000 \text{ Pa}} \quad \text{Ans. (c)}$$

**9.54** For flow of air through a normal shock, the upstream conditions are  $V_1 = 600$  m/s,  $T_{o1} = 500$  K, and  $p_{o1} = 700$  kPa. Compute the downstream conditions  $\text{Ma}_2$ ,  $V_2$ ,  $T_2$ ,  $p_2$ , and  $p_{o2}$ .

**Solution:** First compute the upstream Mach number:

$$T_1 = T_o - \frac{V_1^2}{2c_p} = 500 - \frac{(600)^2}{2(1005)} = 321 \text{ K},$$

$$a_1 = \sqrt{1.4(287)(321)} = 359 \frac{\text{m}}{\text{s}}, \quad \text{Ma}_1 = \frac{600}{359} = \mathbf{1.67}$$

$$\text{so } \text{Ma}_2 = \sqrt{\frac{0.4(1.67)^2 + 2}{2.8(1.67)^2 - 0.4}} \approx \mathbf{0.648} \quad \text{Ans. } \frac{V_2}{V_1} = \frac{2 + 0.4(1.67)^2}{2.4(1.67)^2} = 0.465$$

$$\text{or } V_2 = 0.465(600) \approx \mathbf{279 \text{ m/s}} \quad \text{Ans.}$$

Continue with the temperature and pressure ratios across the shock:

$$\frac{T_2}{T_1} = [2 + 0.4(1.67)^2] \left[ \frac{2.8(1.67)^2 - 0.4}{(2.4(1.67))^2} \right] = 1.44, \quad T_2 = 1.44(321) \approx \mathbf{461 \text{ K}} \quad \text{Ans.},$$

$$p_1 = \frac{700}{[1 + 0.2(1.67)^2]^{3.5}} = 148 \text{ kPa}, \quad \frac{p_2}{p_1} = \frac{2.8(1.67)^2 - 0.4}{2.4} = 3.09,$$

$$\text{or } p_2 \approx \mathbf{458 \text{ kPa}} \quad \text{Ans.}$$

Finally, we can compute the downstream stagnation pressure in two ways:

$$p_{o2} = p_2 (1 + 0.2\text{Ma}_2^2)^{3.5} = 458[1 + 0.2(0.648)^2]^{3.5} \approx \mathbf{607 \text{ kPa}} \quad \text{Ans.}$$

Check Table B.2, at  $\text{Ma}_1 = 1.67$ ,  $p_{o2}/p_{o1} \approx 0.868$ ,  $p_{o2} = 0.868(700) \approx 607 \text{ kPa}$  (check)

**9.55** Air, supplied by a reservoir at 450 kPa, flows through a converging-diverging nozzle whose throat area is  $12 \text{ cm}^2$ . A normal shock stands where  $A_1 = 20 \text{ cm}^2$ . (a) Compute the pressure just downstream of this shock. Still farther downstream, where  $A_3 = 30 \text{ cm}^2$ , estimate (b)  $p_3$ ; (c)  $A_3^*$ ; and (d)  $Ma_3$ .

**Solution:** If a shock forms, the throat must be **choked** (sonic). Use the area ratio at (1):

$$\frac{A_1}{A^*} = \frac{20}{12} = 1.67, \quad \text{or} \quad Ma_1 \approx 1.985, \quad \text{whence} \quad p_1 = \frac{450}{[1 + 0.2(1.985)^2]^{3.5}} \approx 59 \text{ kPa}$$

$$\text{Then, across the shock,} \quad \frac{p_2}{p_1} = \frac{2.8(1.985)^2 - 0.4}{2.4} = 4.43,$$

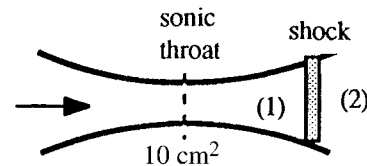
$$p_2 = 4.43(59) \approx \mathbf{261 \text{ kPa}} \quad \text{Ans. (a)}$$

$$\text{Across the shock, at } Ma_1 = 1.985, \quad \frac{A_2^*}{A_1^*} = 1.374, \quad A_2^* = 1.374(12) \approx \mathbf{16.5 \text{ cm}^2} \quad \text{Ans. (c)}$$

$$\text{At } A_3 = 30 \text{ cm}^2, \quad \frac{A_3}{A_2^*} = \frac{30}{16.5} = 1.82, \quad \text{whence subsonic } Ma_3 \approx \mathbf{0.34} \quad \text{Ans. (d)}$$

$$\text{Finally, } p_{o2} = \frac{p_{o1}}{1.374} = 328 \text{ kPa}, \quad p_3 = \frac{328}{[1 + 0.2(0.34)^2]^{3.5}} \approx \mathbf{303 \text{ kPa}} \quad \text{Ans. (b)}$$

**9.56** Air from a reservoir at  $20^\circ\text{C}$  and 500 kPa flows through a duct and forms a normal shock downstream of a throat of area  $10 \text{ cm}^2$ . By an odd coincidence it is found that the stagnation pressure downstream of this shock exactly equals the throat pressure. What is the area where the shock wave stands?



**Solution:** If a shock forms, the throat is **sonic**,  $A^* = 10 \text{ cm}^2$ . Now

$$p_1^* = 0.5283p_{o1} = 0.5283(500) \approx \mathbf{264 \text{ kPa}} = p_{o2} \quad \text{also}$$

$$\text{Then } \frac{p_{o2}}{p_{o1}} = \frac{264}{500} = 0.5283: \quad \text{Table B.2, read } Ma_1 \approx 2.43$$

$$\text{So } A_1/A_1^* = \frac{[1 + 0.2(2.43)^2]^{3.0}}{1.728(2.43)} \approx 2.47, \quad \text{or} \quad A_1(\text{at shock}) = 2.47(10) \approx \mathbf{24.7 \text{ cm}^2} \quad \text{Ans.}$$

**9.57** Air flows from a tank through a nozzle into the standard atmosphere, as in Fig. P9.57. A normal shock stands in the exit of the nozzle, as shown. Estimate (a) the tank pressure; and (b) the mass flow.

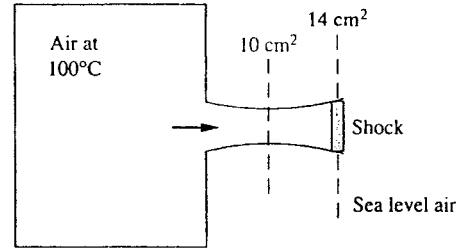


Fig. P9.57

**Solution:** The throat must be *sonic*, and the area ratio at the shock gives the Mach number:

$$A_1/A^* = \frac{14}{10} = 1.4 = \frac{[1 + 0.2\text{Ma}_1^2]^3}{1.728\text{Ma}_1}, \quad \text{solve } \text{Ma}_1 \approx 1.76 \text{ upstream of the shock}$$

$$\text{Then } p_2/p_1|_{\text{shock}} = \frac{2.8(1.76)^2 - 0.4}{2.4} \approx 3.46, \quad p_2 = 1 \text{ atm}, \quad p_1 = \frac{101350}{3.46} \approx 29289 \text{ Pa}$$

$$\text{Thus } p_{\text{tank}} = p_{o1} = 29289[1 + 0.2(1.76)^2]^{3.5} \approx \mathbf{159100 \text{ Pa}} \quad \text{Ans. (a)}$$

Given that  $T_o = 100^\circ\text{C} = 373 \text{ K}$  and a critical throat area of  $10 \text{ cm}^2$ , we obtain

$$\begin{aligned} \dot{m} = \dot{m}_{\text{max}} &= 0.6847p_o A^* / \sqrt{RT_o} = 0.6847(159100)(0.001) / \sqrt{287(373)} \\ &\approx \mathbf{0.333 \frac{\text{kg}}{\text{s}}} \quad \text{Ans. (b)} \end{aligned}$$

**9.58** Argon (Table A.4) approaches a normal shock with  $V_1 = 700 \text{ m/s}$ ,  $p_1 = 125 \text{ kPa}$ , and  $T_1 = 350 \text{ K}$ . Estimate (a)  $V_2$ , and (b)  $p_2$ . (c) What pressure  $p_2$  would result if the same velocity change  $V_1$  to  $V_2$  were accomplished *isentropically*?

**Solution:** For argon, take  $k = 1.67$  and  $R = 208 \text{ J/kg}\cdot\text{K}$ . Determine the Mach number upstream of the shock:

$$a_1 = \sqrt{kRT_1} = \sqrt{1.67(208)(350)} \approx 349 \frac{\text{m}}{\text{s}}; \quad \text{Ma}_1 = V_1/a_1 = \frac{700}{349} \approx \mathbf{2.01}$$

$$\text{Then } \frac{p_2}{p_1}|_{\text{shock}} = \frac{2(1.67)(2.01)^2 - 0.67}{1.67 + 1} \approx 4.79, \quad \text{or } p_2 = 4.79(125) \approx \mathbf{599 \text{ kPa}} \quad \text{Ans. (b)}$$

$$\text{and } V_2/V_1 = \frac{0.67(2.01)^2 + 2}{2.67(2.01)^2} \approx 0.437, \quad \text{or } V_2 = 0.437(700) = \mathbf{306 \frac{\text{m}}{\text{s}}} \quad \text{Ans. (a)}$$

For an “isentropic” calculation, assume the same **density ratio** across the shock:

$$\rho_2/\rho_1 = V_1/V_2 = \frac{1}{0.437} = 2.29; \quad \text{Isentropic: } p_2/p_1 \approx (\rho_2/\rho_1)^k,$$

$$\text{or: } p_{2,\text{isentropic}} \approx 125(2.29)^{1.67} \approx \mathbf{498 \text{ kPa}} \quad \text{Ans. (c)}$$

**9.59** Air, at stagnation conditions of 450 K and 250 kPa, flows through a nozzle. At section 1, where the area = 15 cm<sup>2</sup>, there is a normal shock wave. If the mass flow is 0.4 kg/s, estimate (a) the Mach number; and (b) the stagnation pressure just downstream of the shock.

**Solution:** If there is a shock wave, then the mass flow is maximum:

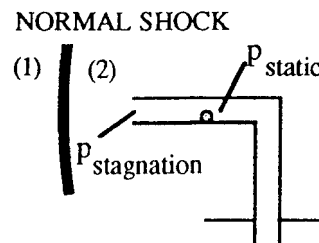
$$\dot{m}_{\max} = 0.4 \frac{\text{kg}}{\text{s}} = 0.6847 \frac{p_o A^*}{\sqrt{RT_o}} = 0.6847 \frac{250000 A^*}{\sqrt{287(450)}}, \quad \text{solve } A^* = 0.000840 \text{ m}^2$$

$$\text{Then } \frac{A_1}{A^*} = \frac{0.0015}{0.00084} = 1.786 \quad \text{Table B.1: Read } Ma_{1,\text{upstream}} \approx 2.067$$

$$\text{Finally, from Table B.2, read } \mathbf{Ma_{1,\text{downstream}} \approx 0.566} \quad \text{Ans. (a)}$$

$$\text{Also, Table B.2: } \frac{p_{o2}}{p_{o1}} = 0.690, \quad \mathbf{p_{0,\text{downstream}} = 0.690(250) \approx 172 \text{ kPa}} \quad \text{Ans. (b)}$$

**9.60** When a pitot tube such as Fig. (6.30) is placed in a supersonic flow, a normal shock will stand in front of the probe. Suppose the probe reads  $p_0 = 190$  kPa and  $p = 150$  kPa. If the stagnation temperature is 400 K, estimate the (supersonic) Mach number and velocity upstream of the shock.



**Fig. P9.60**

**Solution:** We can immediately find  $Ma$  inside the shock:

$$p_{o2}/p_2 = \frac{190}{150} = 1.267 = (1 + 0.2Ma_2^2)^{3.5}, \quad \text{solve } Ma_2 \approx 0.591$$

$$\text{Then, across the shock, } Ma_1^2 = \frac{0.4(0.591)^2 + 2}{2.8(0.591)^2 - 0.4}, \quad \text{solve } \mathbf{Ma_1 \approx 1.92} \quad \text{Ans.}$$

$$T_1 = \frac{400}{[1 + 0.2(1.92)^2]} = 230 \text{ K}, \quad a_1 = \sqrt{1.4(287)(230)} \approx 304 \text{ m/s},$$

$$V_1 = Ma_1 a_1 = (1.92)(304) \approx \mathbf{585 \text{ m/s}} \quad \text{Ans.}$$

**9.61** Repeat Prob. 9.56 except this time let the odd coincidence be that the *static* pressure downstream of the shock exactly equals the throat pressure. What is the area where the shock wave stands?

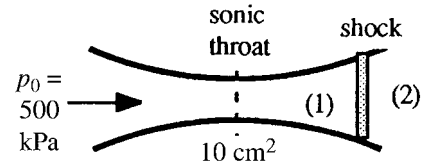


Fig. P9.61

**Solution:** If a shock forms, the throat is **sonic**,  $A^* = 10 \text{ cm}^2$ . Now

$$p_1^* = 0.5283p_{01} = 0.5283(500) = 264 \text{ kPa} = p_2 \quad \text{downstream of the shock}$$

$$\text{Given } p_1 = 500 / (1 + 0.2Ma_1^2)^{3.5} \quad \text{and} \quad p_2/p_1 = (2.8Ma_1^2 - 0.4) / (2.4) \quad \text{and} \quad p_2 = 264$$

Solve iteratively for  $Ma_1 \approx 2.15$  ( $p_1 = 51 \text{ kPa}$ ),  $A_1/A^* = 1.92$ ,  $\therefore \mathbf{A_1 \approx 19.2 \text{ cm}^2}$  Ans.

**9.62** An atomic explosion propagates into still air at 14.7 psia and 520°R. The pressure just inside the shock is 5000 psia. Assuming  $k = 1.4$ , what are the speed  $C$  of the shock and the velocity  $V$  just inside the shock?

**Solution:** The pressure ratio tells us the Mach number of the shock motion:

$$p_2/p_1 = \frac{5000}{14.7} = 340 = \frac{2.8Ma_1^2 - 0.4}{2.4}, \quad \text{solve for } Ma_1 \approx \mathbf{17.1}$$

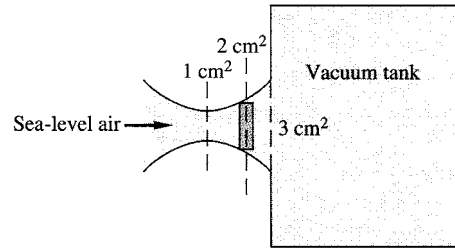
$$a_1 = \sqrt{1.4(1717)(520)} = 1118 \text{ ft/s}, \quad \therefore V_1 = C = 17.1(1118) \approx \mathbf{19100 \frac{ft}{s}} \quad \text{Ans. (a)}$$

We then compute the velocity ratio across the shock and thence the relative motion inside:

$$V_2/V_1 = \frac{0.4(17.1)^2 + 2}{2.4(17.1)^2} = 0.1695, \quad \therefore V_2 = 0.1695(19100) = 3240 \text{ ft/s}$$

$$\text{Then } V_{\text{inside}} = C - V_2 = 19100 - 3240 \approx \mathbf{15900 \text{ ft/s}} \quad \text{Ans. (b)}$$

**9.63** Sea-level standard air is sucked into a vacuum tank through a nozzle, as in Fig. P9.63. A normal shock stands where the nozzle area is  $2 \text{ cm}^2$ , as shown. Estimate (a) the pressure in the tank; and (b) the mass flow.



**Fig. P9.63**

**Solution:** The flow at the exit section (“3”) is *subsonic* (after a shock) therefore must equal the tank pressure. Work our way to 1 and 2 at the shock and thence to 3 in the exit:

$$p_{01} = 101350 \text{ Pa}, \quad A_1/A^* = 2.0, \quad \text{thus } Ma_1 \approx 2.1972, \quad p_1 = \frac{101350}{[1 + 0.2(2.2)^2]^{3.5}} \approx 9520 \text{ Pa}$$

$$\frac{p_2}{p_1} = \frac{2.8(2.2)^2 - 0.4}{2.4} = 5.47, \quad \therefore p_2 = 5.47(9520) \approx 52030 \text{ Pa}$$

$$\text{Also compute } A_2^*/A_1^* \approx 1.59, \quad \text{or } A_2^* = \mathbf{1.59 \text{ cm}^2}$$

Also compute  $p_{02} = 101350/1.59 = 63800 \text{ Pa}$ . Finally compute  $A_3/A_2^* = 3/1.59 = 1.89$ , read  $Ma_3 = 0.327$ , whence  $p_3 = 63800/[1 + 0.2(0.327)^2]^{3.5} \approx \mathbf{59200 \text{ Pa}}$ . *Ans. (a).*

With  $T_0 = 288 \text{ K}$ , the (critical) mass flow  $= 0.6847p_0A^*/\sqrt{RT_0} = \mathbf{0.0241 \text{ kg/s}}$ . *Ans. (b)*

**9.64** Air in a large tank at  $100^\circ\text{C}$  and  $150 \text{ kPa}$  exhausts to the atmosphere through a converging nozzle with a  $5\text{-cm}^2$  throat area. Compute the exit mass flow if the atmospheric pressure is (a)  $100 \text{ kPa}$ ; (b)  $60 \text{ kPa}$ ; and (c)  $30 \text{ kPa}$ .

**Solution:** Choking occurs when  $p_{\text{atmos}} < 0.5283p_{\text{tank}} = 79 \text{ kPa}$ . Therefore the first case is *not choked*, the second two cases *are*. For the first case, with  $T_0 = 100^\circ\text{C} = 373 \text{ K}$ ,

$$(a) \frac{p_0}{p_e} = \frac{150}{100} = 1.5 = (1 + 0.2Ma_e^2)^{3.5}, \quad \text{solve } Ma_e = 0.784, \quad T_e = \frac{373}{1 + 0.2(0.784)^2} = 332 \text{ K}$$

$$\text{and } a_e = \sqrt{1.4(287)(332)} \approx 365 \frac{\text{m}}{\text{s}}, \quad V_e = 0.784(365) = 286 \text{ m/s},$$

$$\text{and } \rho_e = p_e/RT_e = 1.05 \text{ kg/m}^3, \quad \text{finally: } \dot{m} = 1.05(0.0005)(286) = \mathbf{0.150 \text{ kg/s}} \quad \text{Ans. (a)}$$

Both cases (b) and (c) are *choked*, with  $p_{\text{atm}} \leq 79 \text{ kPa}$ , and the mass flow is maximum and driven by tank conditions  $T_0$  and  $p_0$ :

$$(b, c) \dot{m} = \dot{m}_{\text{max}} = \frac{0.6847p_0A^*}{\sqrt{RT_0}} = \frac{0.6847(150000)(0.0005)}{\sqrt{287(373)}} \approx \mathbf{0.157 \frac{\text{kg}}{\text{s}}} \quad \text{Ans. (b, c)}$$

**9.65** Air flows through a converging-diverging nozzle between two large reservoirs, as in Fig. P9.65. A mercury manometer reads  $h = 15$  cm. Estimate the downstream reservoir pressure. Is there a shock wave in the flow? If so, does it stand in the exit plane or farther upstream?

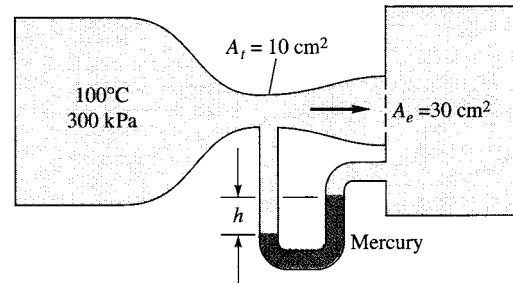


Fig. P9.65

**Solution:** The manometer reads the pressure drop between throat and exit tank:

$$p_{\text{throat}} - p_{\text{tank}\#2} = (\rho_{\text{mercury}} - \rho_{\text{air}})gh \approx (13550 - 0)(9.81)(0.15) \approx 19940 \text{ Pa}$$

The lowest possible  $p_{\text{throat}} = p^* = 0.5283(300) = 158.5 \text{ kPa}$ , for which  $p_e \approx 138.5 \text{ kPa}$

But **this**  $p_e$  is much lower than would occur in the duct for isentropic subsonic flow.

We can check also to see if isentropic *supersonic* flow is a possibility: With  $A_e/A^* = 3.0$ , the exit Mach number would be 2.64, corresponding to  $p_e = 0.047p_o \approx 14 \text{ kPa}$  (?). This is much too low, so that case fails also.

Suppose we had supersonic flow with a normal shock wave in the exit plane:

$$A_e/A^* = 3.0, \quad Ma_e \approx 2.64, \quad p_e = 14 \text{ kPa}, \quad \frac{p_{\text{tank}\#2}}{p_e} = \frac{2.8(2.64)^2 - 0.4}{2.4} = 7.95,$$

or:  $p_{\text{tank}\#2} = 7.95(14) \approx 113 \text{ kPa}$ , compared to  $p_{\text{tank}}$  (manometer reading)  $\approx 138.5 \text{ kPa}$

This doesn't match either, the flow expanded too much before the shock wave. Therefore the correct answer is: **a normal shock wave upstream of the exit plane.** *Ans.*

**9.66** In Prob. 9.65 what would be the mercury manometer reading if the nozzle were operating exactly at supersonic “design” conditions?

**Solution:** We worked out this idealized isentropic-flow condition in Prob. 9.65:

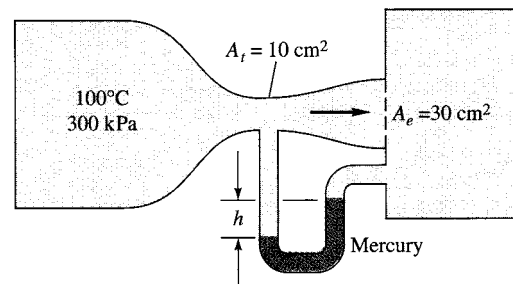


Fig. P9.65

Design flow:  $\frac{A_e}{A^*} = 3.0, \quad Ma_e = 2.64, \quad p_e = 14 \text{ kPa} = p_{\text{tank}\#2}; \quad p^* = p_{\text{throat}} = 158.5 \text{ kPa}$

$$\text{Then } p_t - p_e = 158500 - 14200 = 144300 \approx (13550 - 0)(9.81)h,$$

$$\text{solve } \mathbf{h \approx 1.09 \text{ m} \quad \text{Ans.}}$$

**9.67** In Prob. 9.65 estimate the complete range of manometer readings  $h$  for which the flow through the nozzle is isentropic, except possibly in the exit plane.

**Solution:** First analyze *subsonic* flow throughout the duct: from  $Ma \approx 0$  to  $A/A^* = 3.0$ :

Subsonic choked flow:  $A/A^* = 3.0$ ,  $Ma_e \approx 0.1975$ ,  $p_e = 292 \text{ kPa}$ ,  $p^* = p_t = 158.5 \text{ kPa}$

$$\text{Then } (p_t - p_e) = (158500 - 292000) = (13550 - 0)(9.81)h,$$

$$\text{or } \mathbf{h \approx -1.00 \text{ m} \text{ (high side on the left)}}$$

So, for subsonic isentropic flow, we measure  $\mathbf{-1.00 \text{ m} < \mathbf{h} < \mathbf{0} \quad \text{Ans.}}$

Now analyze *supersonic* isentropic flow, possibly with a normal shock at the exit. One case is a fully overexpanded exit,  $p_e = 0$ ,  $\Delta p = 158500 = 13550(9.81)h$ ,  $h = +1.19 \text{ m}$ . At the other extreme (see Prob. 9.65), a normal shock in the exit causes  $p_e \approx 113 \text{ kPa}$ ,  $\Delta p = (158500 - 113000) = 13550(9.81)h$ , or  $h = +0.34 \text{ m}$ . The complete range is:

$$\mathbf{-1.00 \text{ m} < \mathbf{h} = \mathbf{0} \text{ (subsonic flow) and } \mathbf{+0.34} < \mathbf{h} < \mathbf{1.19 \text{ m} \text{ (supersonic flow) \quad \text{Ans.}}$$

**9.68** Air in a tank at 120 kPa and 300 K exhausts to the atmosphere through a 5-cm<sup>2</sup>-throat converging nozzle at a rate of 0.12 kg/s. What is the atmospheric pressure? What is the maximum mass flow possible at low atmospheric pressure?

**Solution:** Let us answer the second question first, to see where 0.12 kg/s stands:

$$\dot{m}_{\max} = \frac{0.6847 p_o A^*}{\sqrt{RT_o}} = \frac{0.6847(120000)(0.0005)}{\sqrt{287(300)}}$$

$$\approx \mathbf{0.140 \text{ kg/s} \quad \text{Ans. (b) (if } p_{\text{atm}} < 63 \text{ kPa)}}$$

So the given mass flow is about 86% of maximum and  $p_{\text{atm}} > 63 \text{ kPa}$ . We could just go at it, guess the exit pressure and iterating, or we could express it more elegantly:

$$\dot{m} = \rho AV = \frac{\rho_o}{(1 + 0.2Ma^2)^{2.5}} A Ma \sqrt{kR} \sqrt{\frac{T_o}{1 + 0.2Ma^2}} = \frac{\text{Const } Ma}{(1 + 0.2Ma^2)^3},$$

where  $\text{Const} \approx 0.2419$  in SI units. If  $\dot{m} = 0.12 \text{ kg/s}$ , we thus solve for  $Ma$ :

$$\mathbf{Ma \approx 0.496(1 + 0.2Ma^2)^3} \quad \text{to obtain } \mathbf{Ma \approx 0.62, } p_{\text{atm}} \approx \mathbf{92.6 \text{ kPa} \quad \text{Ans.}}$$



**9.69** With reference to Prob. 3.68, show that the thrust of a rocket engine exhausting into a vacuum is given by

$$F = \frac{p_0 A_e (1 + k \text{Ma}_e^2)}{\left(1 + \frac{k-1}{2} \text{Ma}_e^2\right)^{k/(k-1)}}$$

where  $A_e$  = exit area

$\text{Ma}_e$  = exit Mach number

$p_0$  = stagnation pressure in combustion chamber

Note that stagnation temperature does not enter into the thrust.

**Solution:** In a vacuum,  $p_{\text{atm}} = 0$ , the solution to Prob. 3.68 is

$$F = \rho_e A_e V_e^2 + A_e (p_e - 0) = A_e (p_e + \rho_e V_e^2),$$

$$\text{but } \rho_e V_e^2 \equiv k p_e \text{Ma}_e^2, \text{ hence } F = p_e A_e (1 + k \text{Ma}_e^2)$$

$$\text{For isentropic flow, } p_e = p_0 / \left(1 + \frac{k-1}{2} \text{Ma}_e^2\right)^{k/(k-1)}, \therefore F = \frac{p_0 A_e (1 + k \text{Ma}_e^2)}{\left(1 + \frac{k-1}{2} \text{Ma}_e^2\right)^{k/(k-1)}} \text{ Ans.}$$

**9.70** Air, at stagnation temperature  $100^\circ\text{C}$ , expands isentropically through a nozzle of  $6\text{-cm}^2$  throat area and  $18\text{-cm}^2$  exit area. The mass flow is at its maximum value of  $0.5 \text{ kg/s}$ . Estimate the exit pressure for (a) subsonic; and (b) supersonic exit flow.

**Solutions:** These are conditions “C” and “H” in Fig. 9.12b. The mass flow yields  $p_0$ :

$$\dot{m} = \dot{m}_{\text{max}} = 0.5 \frac{\text{kg}}{\text{s}} = \frac{0.6847 p_0 A^*}{\sqrt{RT_0}} = \frac{0.6847 p_0 (0.0006)}{\sqrt{287(373)}}, \text{ solve } p_0 \approx \mathbf{398 \text{ kPa}}$$

(a) Subsonic:  $A_e/A^* = 18/6 = 3.0$ ;  $\text{Ma}_e \approx 0.1975$ ,

$$p_e = \frac{398}{\left(1 + 0.2 \text{Ma}_e^2\right)^{3.5}} \approx \mathbf{388 \text{ kPa}} \text{ Ans. (a)}$$

(b) Supersonic:  $A_e/A^* = 3.0$ ,  $\text{Ma}_e \approx 2.64$ ,  $p_e = \frac{398}{[1 + 0.2(2.64)^2]^{3.5}} \approx \mathbf{19 \text{ kPa}} \text{ Ans. (b)}$

**9.71** For the nozzle of problem 9.70, allowing for non-isentropic flow, what is the range of exit tank pressures  $p_b$  for which (a) the diverging nozzle flow is fully supersonic; (b) the

exit flow is subsonic; (c) the mass flow is independent of  $p_b$ ; (d) the exit plane pressure  $p_e$  is independent of  $p_b$ ; and (e)  $p_e < p_b$ ?

**Solution:** In Prob. 9.70 we computed  $p_o = 398$  kPa and the two ‘design’ Mach numbers.

- (a) If a normal shock at the exit,  $Ma_1 = 2.64$  and  $p_1 = 19$  kPa, then across the shock  $p_2/p_1 = 7.95$ ,  $p_b = 7.95(19) \approx 150$  kPa. Conclusion:  **$0 < p_b < 150$  kPa** Ans. (a)
- Above this, *subsonic* exit flow occurs, for  **$150 < p_b < 398$  kPa** Ans. (b)
- (c) The throat is *choked*,  $\dot{m} = \dot{m}_{\max}$  if  **$0 < p_b < 388$  kPa** (see Prob. 9.70a) Ans. (c)
- (d) The exit-plane pressure is independent of  $p_b$  for  **$0 < p_b < 150$  kPa** Ans. (d)
- (e) Exit plane pressure  $p_e < p_b$  for  **$19 < p_b < 150$  kPa** Ans. (e)

**9.72** A large tank at 500 K and 165 kPa feeds air to a converging nozzle. The back pressure outside the nozzle exit is sea-level standard. What is the appropriate exit diameter if the desired mass flow is 72 kg/h?

**Solution:** Given  $T_o = 500$  K and  $p_o = 165$  kPa. The pressure ratio across the nozzle is  $(101.35 \text{ kPa})/(165 \text{ kPa}) = 0.614 > 0.528$ . Therefore the flow is not choked but instead exits at a high subsonic Mach number, with  $p_{\text{throat}} = p_{\text{atm}} = 101.35$  kPa. Equation (9.47) is handy:

$$\frac{\dot{m}}{A} \frac{\sqrt{RT_o}}{p_o} = \sqrt{\frac{2k}{k-1} \left(\frac{p}{p_o}\right)^{2/k} \left[1 - \left(\frac{p}{p_o}\right)^{(k-1)/k}\right]} = \frac{(72/3600) \sqrt{287(500)}}{A \cdot 165000} = \frac{4.59E-5 \text{ m}^2}{A}$$

$$= \sqrt{\frac{2(1.4)}{0.4} \left(\frac{101}{165}\right)^{2/1.4} \left[1 - \left(\frac{101}{165}\right)^{0.4/1.4}\right]} = 0.673$$

Solve for  $A_{\text{exit}} = 6.82E-5 \text{ m}^2 = \frac{\pi}{4} D_{\text{exit}}^2$ , Solve  **$D_{\text{exit}} = 0.0093$  m** Ans.

**9.73** Air flows isentropically in a converging-diverging nozzle with a throat area of  $3 \text{ cm}^2$ . At section 1, the pressure is 101 kPa,  $T_1 = 300$  K, and  $V_1 = 868$  m/s. (a) Is the nozzle choked? Determine (b)  $A_1$ ; and (c) the mass flow. Suppose, without changing stagnation conditions of  $A_1$ , the flexible throat is reduced to  $2 \text{ cm}^2$ . Assuming shock-free flow, will there be any changes in the gas properties at section 1? If so, calculate the new  $p_1$ ,  $V_1$ , and  $T_1$  and explain.

**Solution:** Check the Mach number. If choked, calculate the mass flow:

$$Ma_1 = \frac{V_1}{A_1} = \frac{868}{\sqrt{1.4(287)(300)}} = 2.50 \quad \text{Supersonic: the nozzle is **choked**.} \quad \text{Ans. (a)}$$

$$p_o = 101[1 + 0.2(2.50)^2]^{3.5} = 1726 \text{ kPa}; \quad T_o = 300[1 + 0.2(2.50)^2] = 675 \text{ K}$$

$$\text{At } Ma_1 = 2.50, \quad \frac{A_1}{A^*} = 2.64 \quad \therefore A_1 = 2.64(3) = \mathbf{7.91 \text{ cm}^2} \quad \text{Ans. (b)}$$

$$\dot{m} = \dot{m}_{max} = 0.6847 \frac{p_o A^*}{\sqrt{RT_o}} = 0.6847 \frac{1726000(0.0003)}{\sqrt{287(675)}} = \mathbf{0.805 \frac{\text{kg}}{\text{s}}} \quad \text{Ans. (c)}$$

If  $p_o$  and  $T_o$  are unchanged and the throat ( $A^*$ ) is reduced from 3.0 to 2.0  $\text{cm}^2$ , the mass flow is cut by one-third and, if  $A_1$  remains the same (7.91  $\text{cm}^2$ ), the area ratio changes and the Mach number will change at section 1:

$$\text{New } \frac{A_1}{A_{new}^*} = \frac{7.91}{2.0} = 3.955; \quad \text{Table B.1: read } Ma_{1,new} \approx \mathbf{2.928}$$

Since the Mach number changes, all properties at section 1 change:

$$p_{1,new} = \frac{1726000}{[1 + 0.2(2.928)^2]^{3.5}} = \mathbf{52300 \text{ Pa}}$$

$$T_{1,new} = \frac{675}{[1 + 0.2(2.928)^2]} = \mathbf{249 \text{ K}}$$

$$V_{1,new} = 2.928\sqrt{1.4(287)(249)} = \mathbf{926 \frac{\text{m}}{\text{s}}}$$

A practical question might be: Does the new, reduced throat shape avoid flow separation and shock waves?

**9.74** The perfect-gas assumption leads smoothly to Mach-number relations which are very convenient (and tabulated). This is not so for a real gas such as steam. To illustrate, let steam at  $T_0 = 500^\circ\text{C}$  and  $p_0 = 2 \text{ MPa}$  expand isentropically through a converging nozzle whose exit area is 10  $\text{cm}^2$ . Using the steam tables, find (a) the exit pressure and (b) the mass flow when the flow is sonic, or choked. What complicates the analysis?

**Solution:** Never mind looking up Steam Tables, the big complication is finding the Mach number—even the software in modern thermo books does not contain the speed of sound. We can make a preliminary estimate with “ideal” steam,  $k \approx 1.33$ ,  $R \approx 461 \text{ J/kg}\cdot\text{K}$ :

$$\text{Approximation: } p_e \approx \frac{p_o}{[1 + (k-1)/2]^{k/(k-1)}} = \frac{2.0 \text{ MW}}{[1 + 0.33/2]^{1.33/0.33}} \approx \mathbf{1.08 \text{ MPa}}$$

$$\dot{m}_{\max} \approx 0.6726 p_o A^* / \sqrt{RT_o} = 0.6726(2,000,000)(0.001) / \sqrt{461(773)} \approx \mathbf{2.25 \text{ kg/s}}$$

This gives us an idea of where to look for the exit flow: around  $p \approx 1.1 \text{ MPa}$ . We can try  $1.10 \text{ MPa}$ , which is too high,  $Ma_e < 1$ , and  $1.05 \text{ MPa}$ , which is too low,  $Ma_e < 1$ , and finally converge to about **1.096 MPa** for the sonic-flow, isentropic exit pressure:

$$T_o = 500^\circ\text{C}, \quad p_o = 2.0 \text{ MPa}, \quad \text{read } s_o \approx 7432 \text{ J/kg}\cdot\text{K} \text{ and } h_o = 3.467\text{E}6 \text{ J/kg}$$

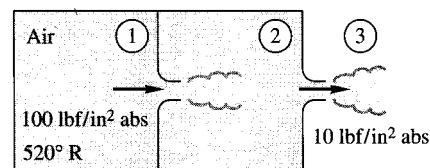
$$\text{Then, at } p_e = \mathbf{1.096 \text{ MPa}} \quad \text{Ans. (a)} \quad \text{read } T_e \approx 676 \text{ K}, \quad \rho_e \approx 3.563 \text{ kg/m}^3,$$

$$h_e \approx 3.269\text{E}6 \text{ J/kg}, \quad \therefore V = \sqrt{2(h_o - h)} = 629 \text{ m/s}, \text{ also read } a_e \approx 629 \text{ m/s (OK, sonic)}$$

$$\text{Finally, } \dot{m} = \rho_e A_e V_e = (3.563)(0.001)(629) \approx \mathbf{2.24 \text{ kg/s}} \quad \text{Ans. (b)}$$

All that effort, and we ended up only 0.5% lower than our ideal-gas estimate!

**9.75** A double-tank system in Fig. P9.75 has two identical converging nozzles of  $1\text{-in}^2$  throat area. Tank 1 is very large, and tank 2 is small enough to be in steady-flow equilibrium with the jet from tank 1. Nozzle flow is isentropic, but entropy changes between 1 and 3 due to jet dissipation in tank 2. Compute the mass flow. (If you give up, Ref. 14, pp. 288–290, has a good discussion.)



**Fig. P9.75**

**Solution:** We know that  $\rho_1 V_1 = \rho_2 V_2$  from continuity. Since  $p_{\text{atm}}$  is so low, we may assume that the second nozzle is choked, but the first nozzle is probably not choked. We may guess values of  $p_2$  and compare the computed values of flow through each nozzle:

$$\text{Assume 2nd nozzle choked: } \rho_3 V_3 = \frac{0.6847 p_2}{\sqrt{RT_o}} \quad \text{with } T_o = 520^\circ\text{R} = \text{constant}$$

$$\text{Guess } p_2 \approx 80 \text{ psia: } \frac{100}{80} = (1 + 0.2 Ma_1^2)^{3.5} \quad \text{or } Ma_1 \approx 0.574, \quad \text{then } \rho_1 \approx 0.0138 \frac{\text{slug}}{\text{ft}^3}$$

and  $V_1 \approx 621$  ft/s, or  $\rho_1 V_1 \approx 8.54$  slug/s·ft<sup>2</sup>, whereas  $\rho_3 V_3 \approx 8.35$  slug/s·ft<sup>2</sup>

Guess  $p_2 \approx 81$  psia:  $Ma_1 \approx 0.557$ ,  $\rho_1 V_1 = 8.38 \frac{\text{slug}}{\text{s}\cdot\text{ft}^2}$  and  $\rho_3 V_3 \approx 8.45 \frac{\text{slug}}{\text{s}\cdot\text{ft}^2}$

Interpolate to:  $p_2 \approx 80.8$  psia,  $Ma_1 \approx 0.561$ ,  $\dot{m} = \rho AV = \mathbf{0.0585 \frac{\text{slug}}{\text{s}}}$  Ans.

**9.76** A large reservoir at 20°C and 800 kPa is used to fill a small insulated tank through a converging-diverging nozzle with 1-cm<sup>2</sup> throat area and 1.66-cm<sup>2</sup> exit area. The small tank has a volume of 1 m<sup>3</sup> and is initially at 20°C and 100 kPa. Estimate the elapsed time when (a) shock waves begin to appear inside the nozzle; and (b) the mass flow begins to drop below its maximum value.

**Solution:** During this entire time the nozzle is choked, so let's compute the mass flow:

$$\dot{m}_e = \dot{m}_{\max} = \frac{0.6847 p_o A^*}{\sqrt{(RT_o)}} = \frac{0.6847(800000)(0.0001)}{\sqrt{287(293)}} \approx \mathbf{0.189 \text{ kg/s}}$$

Meanwhile, a control volume around the small tank reveals a linear pressure rise with time:

$$\dot{m}_e = \frac{d}{dt}(m_{\text{tank}}) = \frac{d}{dt}(\rho v_{\text{tank}}) = \frac{d}{dt}\left(\frac{p_{\text{tank}}}{RT_o} v\right), \quad \text{or:} \quad \frac{dp_{\text{tank}}}{dt} \approx \frac{RT_o \dot{m}}{v}$$

$$\text{Carrying out the numbers gives } \frac{dp}{dt} \approx \frac{287(293)(0.189)}{1.0} \approx 15900 \frac{\text{Pa}}{\text{s}} \approx \text{constant}$$

We are assuming, for simplicity, that the tank stagnation temperature remains at 293 K. Shock waves move into the nozzle when the tank pressure rises above what would occur if the nozzle exit plane were to have a normal shock:

$$\text{If } \frac{A_e}{A^*} = \frac{1.66}{1.0}, \quad \text{then } Ma_e \approx 1.98, \quad p_1 = \frac{800000}{[1 + 0.2(1.98)^2]^{3.5}} \approx 105400 \text{ Pa.}$$

$$\text{After the shock, } \frac{p_2}{p_1} = \frac{2.8(1.98)^2 - 0.4}{2.4} \approx 4.41, \quad \therefore p_2 = p_{\text{tank}} = 4.41(105.4) \approx 465 \text{ kPa}$$

Above this tank pressure, the shock wave moves into the nozzle. The time lapse is

$$\Delta t_{\text{shocks in nozzle}} = \frac{\Delta p_{\text{tank}}}{dp/dt} = \frac{465000 - 100000 \text{ Pa}}{15900 \text{ Pa/s}} \approx \mathbf{23 \text{ sec}} \quad \text{Ans. (a)}$$

Assuming the tank pressure rises smoothly and the shocks do not cause any instability or anything, the nozzle ceases to be choked when  $p_{\text{tank}}$  rises above a subsonic isentropic exit:

$$\frac{A_e}{A^*} = 1.66, \quad \text{then } \text{Ma}_e(\text{subsonic}) \approx 0.380, \quad p_e = \frac{800000}{[1 + 0.2(0.38)^2]^{3.5}} \approx 724300 \text{ Pa}$$

$$\text{Then } \Delta t_{\text{choking stops}} \approx \frac{\Delta p}{dp/dt} = \frac{724300 - 100000}{15900} \approx \mathbf{39 \text{ sec}} \quad \text{Ans. (b)}$$

**9.77** A perfect gas (not air) expands isentropically through a supersonic nozzle with an exit area 5 times its throat area. The exit Mach number is 3.8. What is the specific heat ratio of the gas? What might this gas be? If  $p_o = 300 \text{ kPa}$ , what is the exit pressure of the gas?

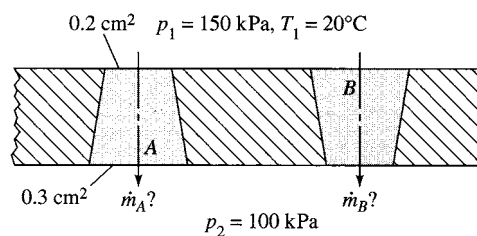
**Solution:** We must iterate the area-ratio formula, Eq. (9.44), for  $k$ :

$$\text{Ma}_e = 3.8, \quad \frac{A_e}{A^*} = 5 = \frac{1}{3.8} \left[ \frac{1 + \frac{k-1}{2}(3.8)^2}{(k+1)/2} \right]^{\frac{k+1}{2(k-1)}}, \quad \text{Solve for } \mathbf{k \approx 1.667} \quad \text{Ans. (a)}$$

Monatomic gas: could be *helium* or *argon*. Ans. (b)

$$\text{With } k \text{ known, } p_e = \frac{300 \text{ kPa}}{\left[ 1 + \left( \frac{1.667-1}{2} \right) (3.8)^2 \right]^{1.667/0.667}} \approx \mathbf{3.7 \text{ kPa}} \quad \text{Ans. (c)}$$

**9.78** The orientation of a hole can make a difference. Consider holes A and B in Fig. P9.78, which are identical but reversed. For the given air properties on either side, compute the mass flow through each hole and explain the difference.



**Fig. P9.78**

**Solution:** Case B is a converging nozzle with  $p_2/p_1 = 100/150 = 0.667 > 0.528$ , therefore case B is **not choked**. Case A is **choked at the entrance** and expands to a (subsonic) pressure of 100 kPa, which we may check from a subsonic calculation. The results are:

$$\text{Nozzle B: } \frac{p_2}{p_o} = 0.667, \quad \text{read } \text{Ma}_2 \approx 0.784, \quad T_e = \frac{293}{[1 + 0.2(0.784)^2]} \approx 261 \text{ K,}$$

$$\rho_e = \frac{100000}{287(261)} = 1.34 \frac{\text{kg}}{\text{m}^3}, \quad a_e = 324 \frac{\text{m}}{\text{s}}, \quad V_e = 254 \frac{\text{m}}{\text{s}},$$

$$\dot{m} = \rho_e A_e V_e \approx \mathbf{0.0068 \frac{\text{kg}}{\text{s}}} \quad \text{Ans. (B)}$$

$$\text{Nozzle A: } \dot{m} = \dot{m}_{\max} = \frac{0.6847(150000)(0.0002)}{\sqrt{287(293)}} \approx \mathbf{0.071 \frac{\text{kg}}{\text{s}}} \quad (5\% \text{ more}) \quad \text{Ans. (A)}$$

**9.79** A large reservoir at 600 K supplies air flow through a converging-diverging nozzle with a throat area of 2 cm<sup>2</sup>. A normal shock wave forms at a section of area 6 cm<sup>2</sup>. Just downstream of this shock, the pressure is 150 kPa. Calculate (a) the pressure in the throat; (b) the mass flow; and (c) the pressure in the reservoir.

**Solution:** The throat is choked, and just upstream of the shock is a supersonic flow at an area ratio  $A/A^* = (6 \text{ cm}^2)/(2 \text{ cm}^2) = 3.0$ . From Table B.1 estimate  $Ma_1 = 2.64$ . That is,

$$\frac{A_1}{A^*} = 3.0 = \frac{(1 + 0.2Ma_1^2)^3}{1.728Ma_1}, \quad \text{Solve } Ma_1 = 2.637$$

(a, c) The pressure ratio across the shock is given by Eq. (9.55) or Table B.2:

$$\begin{aligned} \frac{p_2}{p_1} &= \frac{150 \text{ kPa}}{p_1} = \frac{1}{k+1} (2kMa_1^2 - k + 1) \\ &= \frac{1}{2.4} [2(1.4)(2.637)^2 - 0.4] = 7.95, \quad \text{or } p_1 = 18.9 \text{ kPa} \end{aligned}$$

$$p_{\text{tank}} = p_o = p_1 (1 + 0.2Ma_1^2)^{3.5} = (18.9)[1 + 0.2(2.637)^2]^{3.5} = \mathbf{399 \text{ kPa}} \quad \text{Ans. (c)}$$

$$\text{At the throat, } p = p^* = 0.5283p_o = (0.5283)(399 \text{ kPa}) = \mathbf{211 \text{ kPa}} \quad \text{Ans. (a)}$$

(b) To avoid bothering with density and velocity, Eq. (9.46b) is handy for choked flow.

$$\dot{m}_{\max} = \frac{0.6847p_o A^*}{\sqrt{RT_o}} = \frac{0.6847(399000 \text{ Pa})(0.0002 \text{ m}^2)}{\sqrt{(287 \text{ m}^2/\text{s}^2\text{K})(600 \text{ K})}} = \mathbf{0.132 \text{ kg/s}} \quad \text{Ans. (b)}$$

**9.80** A sea-level automobile tire is initially at 32 lbf/in<sup>2</sup> gage pressure and 75°F. When it is punctured with a hole which resembles a converging nozzle, its pressure drops to 15 lbf/in<sup>2</sup> gage in 12 min. Estimate the size of the hole, in thousandths of an inch.

**Solution:** The volume of the tire is  $2.5 \text{ ft}^3$ . With  $p_{\text{atm}} \approx 14.7 \text{ psi}$ , the absolute pressure drops from 46.7 psia to 29.7 psia, both of which are sufficient to cause a **choked** exit. A theory for isothermal blowdown of a choked tank was given in Prob. 9.36:

$$p_{\text{tank}} = p(0) \exp \left[ -0.6847 \frac{A^* \sqrt{RT_o}}{v} t \right],$$

$$\text{or: } 29.7 = 46.7 \exp \left[ -0.6847 \frac{A^* \sqrt{1717(535)}}{2.5} 12 \times 60 \right],$$

solve  $A^* = 2.4\text{E}-6 \text{ ft}^2$  ( $d = 0.021 \text{ in}$ ) *Ans.*

---

**9.81** Helium, in a large tank at  $100^\circ\text{C}$  and 400 kPa, discharges to a receiver through a converging-diverging nozzle designed to exit at  $\text{Ma} = 2.5$  with exit area  $1.2 \text{ cm}^2$ . Compute (a) the receiver pressure and (b) the mass flow at design conditions. (c) Also estimate the range of receiver pressures for which mass flow will be a maximum.

**Solution:** For helium (Table A.4), take  $k = 1.66$  and  $R = 2077 \text{ J/kg}\cdot^\circ\text{K}$ . At the exit,

$$p_e = p_o / \left[ 1 + \left( \frac{k-1}{2} \right) \text{Ma}_e^2 \right]^{k/(k-1)} = 400 / [1 + 0.33(2.5)^2]^{1.66/0.66} \approx \mathbf{24 \text{ kPa}} \quad \text{Ans. (a)}$$

$$\text{Also, } T_e = \frac{373 \text{ K}}{[1 + 0.33(2.5)^2]} = 122 \text{ K}, \quad a_e = \sqrt{1.66(2077)(122)} = 648 \frac{\text{m}}{\text{s}},$$

$$V_e = \text{Ma}_e a_e = 1620 \frac{\text{m}}{\text{s}}, \quad \rho_e = \frac{p_e}{RT_e} = 0.0947 \frac{\text{kg}}{\text{m}^3}, \quad \dot{m} = \rho_e A_e V_e \approx \mathbf{0.0184 \frac{\text{kg}}{\text{s}}} \quad \text{Ans. (b)}$$

We could also compute  $A/A^* \approx 2.15$ , whence  $A^* \approx 0.56 \text{ cm}^2$ , and use the “maximum mass flow formula,” Eq. (9.46) to compute the throat mass flow, also = 0.0184 kg/s. This choked flow persists up to the “isentropic subsonic exit” condition:

$$\frac{A}{A^*} = 2.15 = \frac{1}{\text{Ma}} \left[ \frac{2 + (k-1)\text{Ma}^2}{k+1} \right]^{\frac{k+1}{2(k-1)}} \quad \text{for } k = 1.66. \quad \text{Solve for } \text{Ma}_{\text{subsonic}} \approx 0.275$$

$$p_e = \frac{400}{[1 + 0.33(0.275)^2]^{1.66/0.66}} \approx 376 \text{ kPa}. \quad \text{Choked flow for } \mathbf{0 < p_e < 376 \text{ kPa}} \quad \text{Ans. (c)}$$


---

**9.82** Air at 500 K flows through a converging-diverging nozzle with throat area of  $1 \text{ cm}^2$  and exit area of  $2.7 \text{ cm}^2$ . When the mass flow is 182.2 kg/h, a pitot-static probe



placed in the exit plane reads  $p_0 = 250.6$  kPa and  $p = 240.1$  kPa. Estimate the exit velocity. Is there a normal shock wave in the duct? If so, compute the Mach number just downstream of this shock.

**Solution:** These numbers **just don't add up** to a purely isentropic flow. For example,  $p_o/p = 250.6/240.1$  yields  $Ma \approx \mathbf{0.248}$ , whereas  $A/A^* = 2.7$  gives  $Ma \approx \mathbf{0.221}$ . If the mass flow is *maximum*, we can estimate the upstream stagnation pressure:

$$\dot{m} \stackrel{?}{=} \dot{m}_{\max} = \frac{182.2}{3600} \stackrel{?}{=} 0.6847 \frac{p_{o1}(0.0001)}{\sqrt{287(500)}} \quad \text{if } p_{o1} \approx \mathbf{280 \text{ kPa}}$$

This doesn't check with the measured value of 250.6 kPa, nor does an isentropic choked subsonic expansion lead to  $p_{\text{exit}} = 240.1$ —it gives **271** kPa instead. We conclude that **there is a normal shock wave in the duct** before the exit plane, reducing  $p_o$ :

$$\text{Normal shock: } \frac{p_{o2}}{p_{o1}} = \frac{250.6}{280.0} = 0.895 \quad \text{if } Ma_1 \approx 1.60 \quad \text{and} \quad \mathbf{Ma_2 \approx 0.67} \quad \text{Ans. (b)}$$

This checks with  $A_2^* \approx 1.12 \text{ cm}^2$ ,  $\frac{A_e}{A_2^*} = 2.42$ ,  $Ma_e \approx 0.248$  (as above)

$$T_e = \frac{500}{[1 + 0.2(0.248)^2]} = 494 \text{ K}, \quad a_e = \sqrt{kRT_e} = 445 \frac{\text{m}}{\text{s}}, \quad \mathbf{V_e = Ma_e a_e \approx 110 \frac{\text{m}}{\text{s}}}$$

**9.83** When operating at design conditions (smooth exit to sea-level pressure), a rocket engine has a thrust of 1 million lbf. The chamber pressure and temperature are 600 lbf/in<sup>2</sup> absolute and 4000°R, respectively. The exhaust gases approximate  $k = 1.38$  with a molecular weight of 26. Estimate (a) the exit Mach number and (b) the throat diameter.

**Solution:** “Design conditions” mean isentropic expansion to  $p_e = 14.7$  psia = 2116 lbf/ft<sup>2</sup>:

$$\frac{p_o}{p_e} = \frac{600}{14.7} = 40.8 = \left[ 1 + \left( \frac{1.38-1}{2} \right) Ma_e^2 \right]^{1.38/0.38}, \quad \text{solve for } \mathbf{Ma_e \approx 3.06} \quad \text{Ans. (a)}$$

From Prob. 3.68, if  $p_e = p_a$ ,

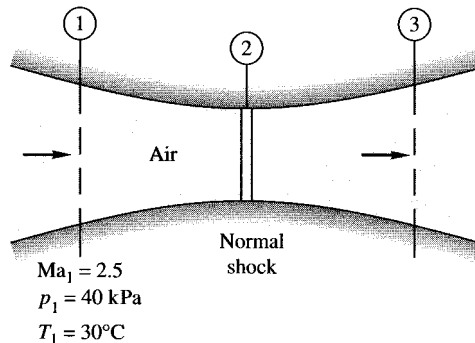
$$F = \rho_e A_e V_e^2 = k p_e A_e Ma_e^2 = 1.38(2116) A_e (3.06)^2 = 1\text{E}6 \text{ lbf}, \quad \text{solve } A_e \approx 36.6 \text{ ft}^2$$

Assuming an isentropic expansion to  $Ma_e \approx 3.06$ , we can compute the throat area:

$$\frac{A_e}{A^*} = \frac{36.6}{A^*} = \frac{1}{3.06} \left[ \frac{2 + 0.38(3.06)^2}{1.38 + 1} \right]^{\frac{2.38}{2(0.38)}} = 4.65, \quad \text{or} \quad A^* = \frac{36.6}{4.65} = 7.87 \text{ ft}^2 = \frac{\pi}{4} D^{*2}$$

Solve for throat diameter  $D^* \approx 3.2 \text{ ft}$  *Ans. (b)*

**9.84** Air flows through a duct as in Fig. P9.84, where  $A_1 = 24 \text{ cm}^2$ ,  $A_2 = 18 \text{ cm}^2$ , and  $A_3 = 32 \text{ cm}^2$ . A normal shock stands at section 2. Compute (a) the mass flow, (b) the Mach number, and (c) the stagnation pressure at section 3.



**Fig. P9.84**

**Solution:** We have enough information at section 1 to compute the mass flow:

$$a_1 = \sqrt{1.4(287)(30 + 273)} \approx 349 \text{ m/s}, \quad V_1 = 2.5(349) = 872 \frac{\text{m}}{\text{s}}, \quad \rho_1 = \frac{p_1}{RT_1} = 0.46 \frac{\text{kg}}{\text{m}^3}$$

$$\text{Then } \dot{m} = \rho_e A_e V_e = 0.46(0.0024)(872) \approx \mathbf{0.96 \text{ kg/s}} \quad \text{Ans. (a)}$$

Now move isentropically from 1 to 2 upstream of the shock and thence across to 3:

$$Ma_1 = 2.5, \quad \therefore \frac{A_1}{A_1^*} = 2.64, \quad A_1^* = \frac{24}{2.64} = 9.1 \text{ cm}^2, \quad \text{and} \quad \frac{A_2}{A_1^*} = \frac{18}{9.1} = 1.98$$

Read  $Ma_{2,\text{upstream}} \approx \mathbf{2.18}$ ,  $p_{o1} = p_{o2} = 40[1 + 0.2(2.5)^2]^{3.5} \approx 683 \text{ kPa}$ , across the

$$\text{shock, } \frac{A_3^*}{A_2^*} = 1.57, \quad A_3^* = 14.3 \text{ cm}^2, \quad \frac{A_3}{A_3^*} = 2.24 \Big|_{\text{sub}}, \quad \mathbf{Ma_3 \approx 0.27} \quad \text{Ans. (b)}$$

Finally, go back and get the stagnation pressure ratio across the shock:

$$\text{at } Ma_2 \approx 2.18, \quad \frac{p_{o3}}{p_{o2}} \approx 0.637, \quad \therefore p_{o3} = 0.637(683) \approx \mathbf{435 \text{ kPa}} \quad \text{Ans. (c)}$$

**9.85** A large tank at 300 kPa delivers air through a nozzle of 1-cm<sup>2</sup> throat area and 2.2-cm<sup>2</sup> exit area. A normal shock wave stands in the exit plane. The temperature just downstream

of this shock is 473 K. Calculate (a) the temperature in the large tank; (b) the receiver pressure; and (c) the mass flow.

**Solution:** First find the Mach number just upstream of the shock and the temperature ratio:

$$\frac{A_{exit}}{A^*} = \frac{2.2 \text{ cm}^2}{1.0 \text{ cm}^2} = 2.2 = \frac{(1 + 0.2Ma_1^2)^3}{1.728Ma_1}, \quad \text{solve for } Ma_1 = 2.303$$

$$\text{Across the shock: } \frac{T_2}{T_1} = \frac{473 \text{ K}}{T_1} = \frac{[2 + 0.4(2.303)^2][2.8(2.303)^2 - 0.4]}{(2.4)^2(2.303)^2} = 1.95, \quad T_1 = 243 \text{ K}$$

$$T_{tank} = T_o = T_1(1 + 0.2Ma_1^2) = (243 \text{ K})[1 + 0.2(2.303)^2] = \mathbf{500 \text{ K}} \quad \text{Ans. (a)}$$

Finally, compute the pressures just upstream and downstream of the shock:

$$p_1 = p_o / (1 + 0.2Ma_1^2)^{3.5} = (300 \text{ kPa}) / [1 + 0.2(2.303)^2]^{3.5} = 23.9 \text{ kPa}$$

$$p_2 = p_{receiver} = \frac{p_1}{k+1} (2kMa_1^2 - k + 1) = \frac{23.9 \text{ kPa}}{(1.4+1)} [2(1.4)(2.303)^2 - 0.4] \\ = \mathbf{144 \text{ kPa}} \quad \text{Ans. (b)}$$

**9.86** Air enters a 3-cm diameter pipe 15 m long at  $V_1 = 73 \text{ m/s}$ ,  $p_1 = 550 \text{ kPa}$ , and  $T_1 = 60^\circ\text{C}$ . The friction factor is 0.018. Compute  $V_2$ ,  $p_2$ ,  $T_2$ , and  $p_{o2}$  at the end of the pipe. How much additional pipe length would cause the exit flow to be sonic?

**Solution:** First compute the inlet Mach number and then get  $(fL/D)_1$ :

$$a_1 = \sqrt{1.4(287)(60 + 273)} = 366 \frac{\text{m}}{\text{s}}, \quad Ma_1 = \frac{73}{366} \approx 0.20, \quad \text{read } \left( \frac{fL}{D} \right) = 14.53,$$

for which  $p/p^* = 5.4554$ ,  $T/T^* = 1.1905$ ,  $V/V^* = 0.2182$ , and  $p_o/p_o^* = 2.9635$

$$\text{Then } (fL/D)_2 = 14.53 - (0.018)(15)/(0.03) \approx 5.53, \quad \text{read } Ma_2 \approx \mathbf{0.295}$$

At this new  $Ma_2$ , read  $p/p^* \approx 3.682$ ,  $T/T^* \approx 1.179$ ,  $V/V^* \approx 0.320$ ,  $p_o/p_o^* \approx 2.067$ . Then

$$V_2 = V_1 \frac{V_2/V^*}{V_1/V^*} = 73 \left( \frac{0.320}{0.218} \right) \approx \mathbf{107 \frac{m}{s}} \quad \text{Ans. (a)}$$

$$p_2 = 550 \left( \frac{3.682}{5.455} \right) \approx \mathbf{371 \text{ kPa}} \quad \text{Ans. (b)}$$

$$T_2 = 333 \left( \frac{1.179}{1.190} \right) \approx \mathbf{330 \text{ K}} \quad \text{Ans. (c)}$$

Now we need  $p_{o1}$  to get  $p_{o2}$ :

$$p_{o1} = 550[1 + 0.2(0.2)^2]^{3.5} \approx 566 \text{ kPa}, \quad \text{so } p_{o2} = 566 \left( \frac{2.067}{2.964} \right) \approx \mathbf{394 \text{ kPa}}$$

The extra distance we need to choke the exit to sonic speed is  $(fL/D)_2 = 5.53$ . That is,

$$\Delta L = 5.53 \frac{D}{f} = 5.53 \left( \frac{0.03}{0.018} \right) \approx \mathbf{9.2 \text{ m}} \quad \text{Ans.}$$

**9.87** Air enters an adiabatic duct of  $L/D = 40$  at  $V_1 = 170$  m/s and  $T_1 = 300$  K. The flow at the exit is choked. What is the average friction factor in the duct?

**Solution:** Noting that  $Ma_{\text{exit}} = 1.0$ , compute  $Ma_1$ , find  $fL/D$  and hence  $f$ :

$$Ma_1 = \frac{V_1}{a_1} = \frac{170}{\sqrt{1.4(287)(300)}} = \frac{170}{347} = 0.49,$$

Table B.3: read  $f \frac{L}{D} \approx 1.15$  Then  $f = \frac{1.15}{40} \approx \mathbf{0.029}$  Ans.

**9.88** Air enters a 5- by 5-cm square duct at  $V_1 = 900$  m/s and  $T_1 = 300$  K. The friction factor is 0.02. For what length duct will the flow exactly decelerate to  $Ma = 1.0$ ? If the duct length is 2 m, will there be a normal shock in the duct? If so, at what Mach number will it occur?

**Solution:** First compute the inlet Mach number, which is decidedly supersonic:

$$Ma_1 = \frac{V_1}{a_1} = \frac{900}{\sqrt{1.4(287)(300)}} \approx 2.59,$$

read  $(fL/D)_1 \approx 0.451$ , whence  $L^*|_{Ma=1} = 0.451 \left( \frac{0.05}{0.02} \right) \approx \mathbf{1.13 \text{ m}}$  Ans.

[We are taking the “hydraulic diameter” of the square duct to be 5 cm.] If the actual duct length = 2 m  $>$   $L^*$ , then there **must be a normal shock** in the duct. By trial and error, we need a total dimensionless length  $(fL/D) = 0.02(2)/0.05 \approx \mathbf{0.8}$ . The result is:

$$Ma_1 = 2.59, \quad \frac{fL}{D}|_1 = 0.451, \quad Ma_2 = \mathbf{2.14}, \quad \frac{fL}{D}|_2 = 0.345,$$

$$\text{shock: } Ma_3 = 0.555, \quad \frac{fL}{D}|_3 = 0.695$$

Total  $fL/D = 0.451 - 0.345 + 0.695 = 0.801$  (close enough)  $\therefore \mathbf{Ma_2 = 2.14}$  Ans.

**9.89** Carbon dioxide flows through an insulated pipe 25 m long and 8 cm in diameter. The friction factor is 0.025. At the entrance,  $p = 300$  kPa and  $T = 400$  K. The mass flow is 1.5 kg/s. Estimate the pressure drop by (a) compressible; and (b) incompressible (Sect. 6.6) flow theory. (c) For what pipe length will the exit flow be choked?

**Solution:** For  $\text{CO}_2$ , from Table A.4, take  $k = 1.30$  and  $R = 189$  J/kg·K. Tough calculation, no appendix tables for  $\text{CO}_2$ , should probably use EES. Find inlet density, velocity, Mach number:

$$\rho_1 = \frac{p_1}{RT_1} = \frac{300000 \text{ Pa}}{(189 \text{ J/kg}\cdot\text{K})(400 \text{ K})} = 3.97 \frac{\text{kg}}{\text{m}^3}$$

$$\dot{m} = 1.5 \frac{\text{kg}}{\text{s}} = \rho_1 A_1 V_1 = \left(3.97 \frac{\text{kg}}{\text{m}^3}\right) \left(\frac{\pi}{4}\right) (0.08 \text{ m})^2 V_1, \quad \text{Solve for } V_1 = 75.2 \text{ m/s}$$

$$Ma_1 = \frac{V_1}{\sqrt{kRT_1}} = \frac{75.2 \text{ m/s}}{\sqrt{(1.3)(189 \text{ m}^2/\text{s}^2\cdot\text{K})(400 \text{ K})}} = \frac{75.2 \text{ m/s}}{313.5 \text{ m/s}} = \mathbf{0.240}$$

Between section 1 (inlet) and section 2 (exit), the **change** in  $(fL/D)$  equals  $(0.025)(25 \text{ m})/(0.08 \text{ m}) = 7.813$ . We have to find the correct exit Mach number from this change:

$$fL^*/D = \frac{1 - Ma^2}{kMa^2} + \frac{k+1}{2k} \ln \left[ \frac{(k+1)Ma^2}{2 + (k-1)Ma^2} \right]$$

For  $k = 1.3$  and  $Ma_1 = 0.240$  compute  $(fL^*/D)_1 = 10.190$

Then  $(fL^*/D)_2 = 10.190 - 7.813 = 2.377$  for what Mach number?

Then iterate (or use EES) to the exit value  $Ma_2 = \mathbf{0.408}$

Now compute  $p_1/p^* = 4.452$  and  $p_2/p^* = 2.600$

Then  $p_2 = p_1(p_2/p^*)/(p_1/p^*) = (300 \text{ kPa})(2.600)/(4.452) = 175 \text{ kPa}$

The desired compressible pressure drop =  $300 - 175 = \mathbf{125 \text{ kPa}}$  *Ans. (a)*

(b) The incompressible flow theory (Chap. 6) simply predicts that

$$\Delta p_{inc} = \frac{fL}{D} \frac{\rho_1}{2} V_1^2 = (7.813) \left( \frac{3.97 \text{ kg/m}^3}{2} \right) \left( 75.2 \frac{\text{m}}{\text{s}} \right)^2 = 88000 \text{ Pa} = \mathbf{88 \text{ kPa}}$$
 *Ans. (b)*

The incompressible estimate is 30% low. Finally, the inlet value of  $(fL/D)$  tells us the maximum possible pipe length for choking at the exit:

$$L_{\max} = \frac{fL^*}{D} \bigg|_1 \left( \frac{D}{f} \right) = (10.19) \left( \frac{0.08 \text{ m}}{0.025} \right) = \mathbf{32.6 \text{ m}}$$
 *Ans. (c)*


---

**9.90** Air, supplied at  $p_0 = 700$  kPa and  $T_0 = 330$  K, flows through a converging nozzle into a pipe of 2.5-cm diameter which exits to a near vacuum. If  $\bar{f} = 0.022$ , what will be the mass flow through the pipe if its length is (a) 0 m, (b) 1 m, and (c) 10 m?

**Solution:** (a) With no pipe ( $L = 0$ ), the mass-flow is simply the isentropic maximum:

$$\dot{m} = \dot{m}_{\max} = 0.6847 \frac{p_0 A^*}{\sqrt{RT_0}} = 0.6847 \frac{700000(\pi/4)(0.025)^2}{\sqrt{287(330)}} \approx \mathbf{0.764 \frac{\text{kg}}{\text{s}}} \quad \text{Ans. (a)}$$

(b) With a finite length  $L = 1$  m, the flow will choke in the exit plane instead:

$$\text{Ma}_e = 1.0, \quad \frac{fL}{D} = \frac{0.022(1.0)}{0.025} = 0.88, \quad \text{read } \text{Ma}_1(\text{entrance}) \approx 0.525$$

$$\text{Then } T_1 = 330/[1 + 0.2(0.525)^2] = 313 \text{ K}, \quad a_1 = \sqrt{1.4(287)(313)} \approx 354 \text{ m/s},$$

$$V_1 = \text{Ma}_1 a_1 = 186 \text{ m/s}, \quad p_1 = 700/[1 + 0.2(0.525)^2]^{3.5} = 580 \text{ kPa},$$

$$\rho_1 = p_1/(RT_1) = 6.46 \text{ kg/m}^3$$

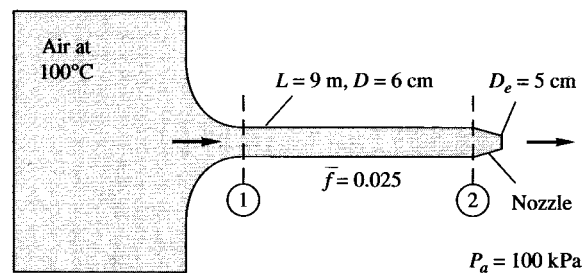
$$\text{Finally, then, } \dot{m} = \rho_1 A_1 V_1 = (6.46)(\pi/4)(0.025)^2(186) \approx \mathbf{0.590 \frac{\text{kg}}{\text{s}}} \quad (23\% \text{ less}) \quad \text{Ans. (b)}$$

(c) Repeat part (b) for a much longer length,  $L = 10$  m:

$$\frac{fL}{D} = \frac{0.022(10)}{0.025} = 8.8, \quad \text{Ma}_1 = 0.246, \quad T_1 = 326 \text{ K}, \quad a_1 = 362 \frac{\text{m}}{\text{s}}, \quad V_1 = 89 \frac{\text{m}}{\text{s}},$$

$$\text{also, } p_1 = 671 \text{ kPa}, \quad \rho_1 = 7.17 \frac{\text{kg}}{\text{m}^3}, \quad \dot{m} = \rho_1 A_1 V_1 \approx \mathbf{0.314 \frac{\text{kg}}{\text{s}}} \quad (59\% \text{ less}) \quad \text{Ans. (c)}$$

**9.91** Air flows steadily from a tank through the pipe in Fig. P9.91. There is a converging nozzle on the end. If the mass flow is 3 kg/s and the flow is choked, estimate (a) the Mach number at section 1; and (b) the pressure in the tank.



**Fig. P9.91**

**Solution:** For adiabatic flow,  $T^* = \text{constant} = T_0/1.2 = 373/1.2 = 311 \text{ K}$ . The flow chokes in the small exit nozzle,  $D = 5 \text{ cm}$ . Then we estimate  $\text{Ma}_2$  from isentropic theory:

$$\frac{A_2}{A^*} = \left( \frac{6 \text{ cm}}{5 \text{ cm}} \right)^2 = 1.44, \quad \text{read } \text{Ma}_2(\text{subsonic}) \approx 0.45, \text{ for which } fL/D|_2 \approx 1.52,$$

$$p_2/p^* \approx 2.388, \quad p_{o2}/p_o^* \approx 1.449, \quad \rho_2/\rho^* \approx 2.070, \quad T_2/T^* = 1.153 \quad \text{or} \quad T_2 \approx 359 \text{ K}$$

$$\text{Given } \dot{m} = 3 \frac{\text{kg}}{\text{s}} = \rho_2 A_2 V_2 = \frac{p_2}{287(359)} \left( \frac{\pi}{4} \right) (0.06)^2 (0.45) \sqrt{1.4(287)(359)},$$

$$\text{Solve for } p_2 \approx 640 \text{ kPa. Then } p^* = 640/2.388 \approx 268 \text{ kPa}$$

$$\text{At section 1, } \frac{fL}{D} = \frac{fL}{D}|_2 + \frac{f\Delta L}{D} = 1.52 + \frac{0.025(9)}{0.06} \approx 5.27, \quad \text{read } \text{Ma}_1 \approx \mathbf{0.30} \quad \text{Ans. (a)}$$

$$\text{for which } p_1/p^* \approx 3.6, \quad \text{or } p_1 \approx 3.6(268) \approx 965 \text{ kPa.}$$

Assuming isentropic flow in the inlet nozzle,

$$p_{\text{tank}} \approx 965[1 + 0.2(0.30)^2]^{3.5} \approx \mathbf{1030 \text{ kPa}} \quad \text{Ans. (b)}$$

**9.92** Modify Prob. 9.91 as follows: Let the tank pressure be 700 kPa, and let the nozzle be *choked*. Determine (a)  $\text{Ma}_2$ ; and (b) the mass flow. Keep  $T_0 = 100^\circ\text{C}$ .

**Solution:** This is the reverse of Prob. 9.91 and is easier. The Mach numbers are the same, since they depend only upon  $fL/D$  (which is the same) and the two nozzle area ratios. If we didn't know the solution to Prob. 9.91, we would guess  $\text{Ma}_1$ , work out  $\text{Ma}_2$  and see if the flow then expands exactly to a sonic exit at the second nozzle. Repeat, if necessary, until the progression through the pipe and the second nozzle is choked. The results are:

$$\text{Ma}_1 = 0.30, \quad \text{compute } p_1 = 700/[1 + 0.2(0.30)^2]^{3.5} \approx 658 \text{ kPa. In Table B.3, read}$$

$$p_1/p^* \approx 3.6, \quad \text{or } p^* = \frac{658}{3.6} \approx 183 \text{ kPa. Also read } fL/D|_1 \approx 5.27, \text{ subtract } f\Delta L/D \text{ of } 3.75$$

$$\text{to find } fL/D|_2 \approx 1.52, \text{ read } \text{Ma}_2 \approx \mathbf{0.45} \quad \text{Ans. (a) Table B.1: } A_2/A^* \approx 1.44$$

$$\text{Then } A_{\text{exit}}/A^* = \frac{1.44}{(6/5)^2} \approx 1.0 \text{ (exactly what we want, } \textit{sonic flow exit}).$$

$$\text{Go back to sections 1 or 2 to compute } \dot{m} = \rho_1 A_1 V_1 = \rho_2 A_2 V_2 \approx \mathbf{2.04 \text{ kg/s}} \quad \text{Ans. (b)}$$

**9.93** Air flows adiabatically in a 3-cm-diameter duct with  $f = 0.015$ . At the entrance,  $V = 950 \text{ m/s}$  and  $T = 250 \text{ K}$ . How far down the tube will (a) the Mach number be 1.8; and (b) the flow be choked?

**Solution:** (a) Find the entrance Mach number and its value of  $fL/d$ :

$$Ma_1 = \frac{950}{\sqrt{1.4(287)(250)}} = 3.00; \quad \text{Table B.3: read } f \frac{L_1}{D} = 0.5222; \quad \text{at } Ma_2 = 1.8,$$

$$\text{read } f \frac{L_2}{D} = 0.2419; \quad \Delta \left( f \frac{L}{D} \right) = 0.5222 - 0.2419 \approx 0.28,$$

$$\Delta L = \frac{0.28(0.03)}{0.015} = \mathbf{0.56 \text{ m}} \quad \text{Ans. (a)}$$

(b) To go all the way to choking requires the full change

$$f\Delta L_1/D = 0.5222, \quad \text{or: } \Delta L_{\text{choke}} = (0.5222)(0.03)/(0.015) = \mathbf{1.04 \text{ m}} \quad \text{Ans. (b)}$$

**9.94** Compressible pipe flow with friction, Sec. 9.7, assumes constant stagnation enthalpy and mass flow but variable momentum. Such a flow is often called *Fanno flow*, and a line representing all possible property changes on a temperature-entropy chart is called a Fanno line. Assuming an ideal gas with  $k = 1.4$  and the data of Prob. 9.86, draw a Fanno line for a range of velocities from very low ( $Ma \ll 1$ ) to very high ( $Ma \gg 1$ ). Comment on the meaning of the maximum-entropy point on this curve.

**Solution:** Recall from Prob. 9.86 that, at Section 1 of the pipe,  $V_1 = 73 \text{ m/s}$ ,  $p_1 = 550 \text{ kPa}$ , and  $T_1 = 60^\circ\text{C} = 333 \text{ K}$ , with  $f \approx 0.018$ . We can then easily compute  $Ma_1 \approx 0.20$ ,  $\rho_1 = 5.76 \text{ kg/m}^3$ ,  $V_{\text{max}} = 822 \text{ m/s}$ , and  $T_o = 336 \text{ K}$ . Our basic algebraic equations are:

$$\text{Energy: } T = T_o - \frac{V^2}{2c_p}, \quad \text{or: } \mathbf{T = 336 \text{ K} - \frac{V^2}{2(1005)}} \quad \text{(a)}$$

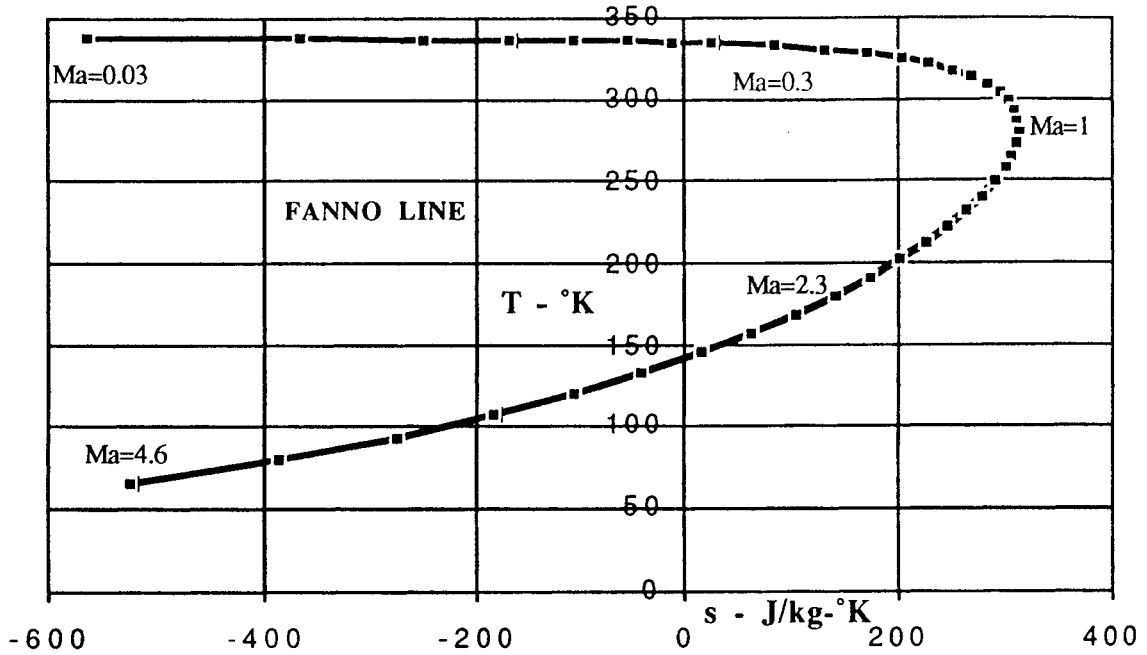
$$\text{Continuity: } \rho V = \rho_1 V_1 = 5.76(73), \quad \text{or: } \mathbf{\rho = 420/V} \quad \text{(b)}$$

$$\text{Entropy: } \mathbf{s = 718 \ln(T/333) - 287 \ln(\rho/5.76)} \quad \text{(c)}$$

We simply let  $V$  vary from, say, 10 m/s to 800 m/s, compute  $\rho$  from (b) and  $T$  from (a) and  $s$  from (c), then plot  $T$  versus  $s$ . [We have arbitrarily set  $s = 0$  at state 1.]

The result of this exercise forms the **Fanno Line** for this flow, shown on the next page. Some Mach numbers are listed, subsonic on the top, supersonic on the bottom, and exactly **sonic** at the right-hand (maximum-entropy) side. *Ans.*





**9.95** Helium (Table A.4) enters a 5-cm-diameter pipe at  $p_1 = 550$  kPa,  $V_1 = 312$  m/s, and  $T_1 = 40^\circ\text{C}$ . The friction factor is 0.025. If the flow is choked, determine (a) the length of the duct and (b) the exit pressure.

**Solution:** For helium, take  $k = 1.66$  and  $R = 2077$  J/kg·K. We have no tables for  $k = 1.66$ , have to do our best anyway. Compute the Mach number at section 1:

$$a_1 = \sqrt{(1.66)(2077)(40 + 273)} \approx 1039 \text{ m/s}, \quad \text{Ma}_1 = V_1/a_1 = \frac{312}{1039} \approx \mathbf{0.300}$$

$$\text{Eq. 9.66: } \frac{fL}{D} = \frac{1 - (0.3)^2}{1.66(0.3)^2} + \frac{2.66}{2(1.66)} \ln \left[ \frac{(2.66)(0.3)^2}{2 + (0.66)(0.3)^2} \right] \approx 4.37 \quad \text{at section 1}$$

$$\text{Choked: } fL/D|_2 = 0, \quad \therefore L = 4.37D/f = 4.37(0.05)/(0.025) \approx \mathbf{8.7 \text{ m}} \quad \text{Ans. (a)}$$

$$\text{Also, } p_1/p^* = \frac{1}{0.3} \left[ \frac{2.66}{2 + 0.66(0.3)^2} \right]^{1/2} \approx 3.79, \quad \therefore p_{\text{exit}} = p^* = \frac{550}{3.79} \approx \mathbf{145 \text{ kPa}} \quad \text{Ans. (b)}$$

**9.96** Methane ( $\text{CH}_4$ ) flows through an insulated 15-cm-diameter pipe with  $f = 0.023$ . Entrance conditions are 600 kPa,  $100^\circ\text{C}$ , and a mass flow of 5 kg/s. What lengths of pipe will (a) choke the flow; (b) raise the velocity by 50%; (c) decrease the pressure by 50%?

**Solution:** For methane (CH<sub>4</sub>), from Table A.4, take  $k = 1.32$  and  $R = 518 \text{ J/kg}\cdot\text{K}$ . Tough calculation, no appendix tables for methane, should probably use EES. Find inlet density, velocity, Mach number:

$$\rho_1 = \frac{p_1}{RT_1} = \frac{600000 \text{ Pa}}{(518 \text{ J/kg}\cdot\text{K})(373 \text{ K})} = 3.11 \frac{\text{kg}}{\text{m}^3}$$

$$\dot{m} = 5 \text{ kg/s} = \rho_1 A_1 V_1 = (3.11 \text{ kg/m}^3) \left( \frac{\pi}{4} \right) (0.15 \text{ m})^2 V_1, \quad \text{solve for } V_1 = 91.1 \text{ m/s}$$

$$a_1 = \sqrt{kRT_1} = \sqrt{1.32(518)(373)} = 505 \text{ m/s}, \quad Ma_1 = \frac{V_1}{a_1} = \frac{91.1 \text{ m/s}}{505 \text{ m/s}} = 0.180$$

Now we have to work out the pipe-friction relations, Eqs. (9.66) and (9.68), for  $k = 1.32$ . We need  $fL^*/D$ ,  $V/V^*$ , and  $p/p^*$  at the inlet,  $Ma = 0.18$ :

$$\frac{fL^*}{D} = \frac{1 - Ma^2}{kMa^2} + \frac{k+1}{2k} \ln \left[ \frac{(k+1)Ma^2}{2 + (k-1)Ma^2} \right] = 19.63 \quad \text{at } Ma_1 = 0.18 \quad \text{and } k = 1.32$$

$$\text{Solve } L_{choking}^* = 19.63 \frac{D}{f} = 19.63 \left( \frac{0.15 \text{ m}}{0.023} \right) = \mathbf{128 \text{ m}} \quad \text{Ans. (a)}$$

$$\frac{fL^*}{D} = \frac{1 - Ma^2}{kMa^2} + \frac{k+1}{2k} \ln \left[ \frac{(k+1)Ma^2}{2 + (k-1)Ma^2} \right] = 19.63 \quad \text{at } Ma_1 = 0.18 \quad \text{and } k = 1.32$$

$$\text{Solve } L_{choking}^* = 19.63 \frac{D}{f} = 19.63 \left( \frac{0.15 \text{ m}}{0.023} \right) = \mathbf{128 \text{ m}} \quad \text{Ans. (a)}$$

$$\frac{p}{p^*} = \frac{1}{Ma} \left[ \frac{k+1}{2 + (k-1)Ma^2} \right]^{1/2} = 5.954 \quad \text{at } Ma_1 = 0.18 \quad \text{and } k = 1.32$$

Decrease 50% to:  $p/p^* = 2.977$  Solve for:  $Ma_2 = 0.358$ ,  $fL^*/D = 3.46$

$$\text{Solve: } \Delta L^* = (19.63 - 3.46) \frac{D}{f} = 16.17 \left( \frac{0.15 \text{ m}}{0.023} \right) = \mathbf{105 \text{ m}} \quad \text{Ans. (c)}$$

**9.97** By making a few algebraic substitutions, show that Eq. (9.74), or the relation in Prob. 9.96, may be written in the density form

$$\rho_1^2 = \rho_2^2 + \rho^{*2} \left( \frac{2k}{k+1} \frac{\bar{f}L}{D} + 2 \ln \frac{\rho_1}{\rho_2} \right)$$

Why is this formula awkward if one is trying to solve for the mass flow when the pressures are given at sections 1 and 2?

**Solution:** This much less laborious algebraic derivation is left as a student exercise. There are two awkward bits: (1) we don't know  $\rho_1$  and  $\rho_2$ ; and (2) we don't know  $\rho^*$  either.

**9.98** Compressible *laminar* flow,  $f \approx 64/\text{Re}$ , may occur in capillary tubes. Consider air, at stagnation conditions of 100°C and 200 kPa, entering a tube 3 cm long and 0.1 mm in diameter. If the receiver pressure is near vacuum, estimate (a) the average Reynolds number, (b) the Mach number at the entrance, and (c) the mass flow in kg/h.

**Solution:** The pipe is choked, “receiver pressure near vacuum,” so  $L = L^*$  and we need only to correctly guess the inlet Mach number and iterate until the Table B.3 value of  $(fL/D)$  matches the actual value, with  $f \approx 64/\text{Re}$  from laminar pipe theory. Since  $\text{Re} = \rho V D / \mu$  and  $\rho V$  is constant due to mass conservation,  $\text{Re}$  varies only due to the change in  $\mu$  with temperature (from about  $2.1\text{E}-5$  in the entrance to  $1.9\text{E}-5$  kg/m·s at the exit). We assume  $\mu_{\text{avg}} \approx 2.0\text{E}-5$  kg/m·s. Try  $\text{Ma}_1$  from 0.1 to 0.2 and find **0.12** to be the best estimate:

**$\text{Ma}_1 \approx 0.12$**  Ans. (b) Table B.3:  $(fL/D)_1 \approx 45.4$ , also compute

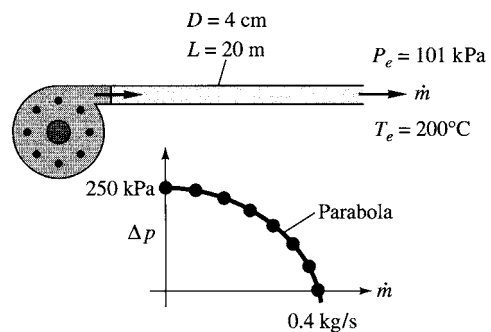
$$T_1 = 372 \text{ K}, V_1 = 46 \text{ m/s}, \rho_1 = 1.85 \frac{\text{kg}}{\text{m}^3}, \text{Re}_{\text{avg}} = \frac{1.85(46)(0.0001)}{2.0\text{E}-5} = \mathbf{430} \quad \text{Ans. (a)}$$

Then  $f_{\text{laminar}} \approx 64/430 = 0.15$ ,  $f(L/D) = 0.15(300) \approx 45.0$  (close enough for me!)

$$\text{The mass flow is } \dot{m} = \rho_1 A_1 V_1 = 1.85(\pi/4)(0.0001)^2(46) \approx \mathbf{6.74\text{E}-7} \frac{\text{kg}}{\text{s}} \quad \text{Ans. (c)}$$

$$\mathbf{(0.00243 \text{ kg/h})}$$

**9.99** A compressor forces air through a smooth pipe 20 m long and 4 cm in diameter, as in Fig. P9.99. The air leaves at 101 kPa and 200°C. The compressor data for pressure rise versus mass flow are shown in the figure. Using the Moody chart to estimate  $\bar{f}$ , compute the resulting mass flow.



**Fig. P9.99**

**Solution:** The compressor performance is approximate by the parabolic relation

$$\Delta p_{\text{compressor}} \approx 250 - 1563 \dot{m}^2, \text{ with } \Delta p \text{ in kPa and } \dot{m} \text{ in kg/s}$$

We must match this to the pressure drop due to friction in the pipe. For preliminaries, compute  $\rho_e = p_e/RT_e = \mathbf{0.744 \text{ kg/m}^3}$ , and  $a_e = \sqrt{(kRT_e)} = \mathbf{436 \text{ m/s}}$ . Guess the mass flow:

$$\dot{m} \stackrel{?}{=} 0.2 \text{ kg/s}, \quad \text{then } Re = \frac{4\dot{m}}{\pi D \mu} = \frac{4(0.2)}{\pi(0.04)(2.5E-5)} \approx 255000, \quad f_{\text{Moody}} \approx 0.015$$

$$V_e = \frac{Re\mu}{\rho_e D} = \frac{255000(2.5E-5)}{0.744(0.04)} \approx 214 \frac{\text{m}}{\text{s}}, \quad Ma_e = \frac{214}{436} = 0.491, \quad \text{read } \left. \frac{fL}{D} \right|_e \approx 1.15,$$

$$\text{also read } p_e/p^* \approx 2.18, \quad p^* = \frac{101000}{2.18} \approx 46300 \text{ Pa}$$

Then, at the pipe entrance (Sect. 1), we may compute  $fL/D$  and find the pressure there:

$$\left. \frac{fL}{D} \right|_1 = 1.15 + \frac{0.015(20)}{0.04} = 8.65, \quad \text{read } Ma_1 \approx 0.248, \quad \frac{p_1}{p^*} \approx 4.39,$$

$$\therefore p_2 = 4.39(46300) \quad \text{or} \quad p_2 \approx 203 \text{ kPa},$$

$$\text{or } \Delta p_{\text{pipe}} = 203 - 101 \approx 102 \text{ kPa} \quad \text{whereas } \Delta p_{\text{comp}} \approx 187 \text{ kPa} \quad (\dot{m} \text{ too small})$$

We increase the mass flow until  $\Delta p_{\text{pipe}} \approx \Delta p_{\text{compressor}}$ . The final converged result is:

$$\dot{m} = \mathbf{0.256 \frac{\text{kg}}{\text{s}}}, \quad Re \approx 326000, \quad f \approx 0.0142, \quad V_e \approx 274 \frac{\text{m}}{\text{s}}, \quad Ma_e \approx 0.628, \quad \text{read}$$

$$\left. \frac{fL}{D} \right|_e \approx 0.39, \quad p_e/p^* \approx 1.68, \quad p^* \approx 60.1 \text{ kPa}, \quad \text{add } f\Delta L/D = 7.1 \text{ to get } \left. \frac{fL}{D} \right|_1 \approx \mathbf{7.49},$$

$$\text{read } Ma_1 \approx 0.263, \quad p_1/p^* \approx 4.14, \quad p_2 \approx 249 \text{ kPa}, \quad \Delta p_{\text{pipe}} \approx 148 \text{ kPa} = \Delta p_{\text{compressor}} \text{ (OK)}$$

For these operating conditions, the approximate flow rate is **0.256 kg/s**. *Ans.*

**9.100** Modify Prob. 9.99 as follows: Find the length of 4-cm-diameter pipe for which the pump pressure rise will be exactly 200 kPa.

**Solution:** With  $\Delta p$  known, we can immediately compute the mass flow and  $Re$ ,  $f$ , etc.:

$$\Delta p = 200 = 250 - 1563\dot{m}^2, \quad \text{solve } \dot{m} \approx 0.179 \text{ kg/s}, \quad Re = \frac{4\dot{m}}{\pi\mu D} = 228000$$

$$V_e = \frac{\mu Re}{\rho D} = 191 \frac{\text{m}}{\text{s}}, \quad Ma_e = \frac{191}{436} \approx 0.44, \quad \text{read } \left. \frac{fL}{D} \right|_e \approx 1.69, \quad p_e/p^* = 2.44,$$

$$p^* = \frac{101}{2.44} = 41.4 \text{ kPa}, \quad f_{\text{Moody}} \approx 0.0152, \quad \text{Now we want } p_1 - p_e = 200 \text{ kPa}$$

Thus  $p_1 = 200 + 101 = 301 \text{ kPa}$ ,  $\frac{p_1}{p^*} = \frac{301}{41.4} = 7.27$ , read  $Ma_1 \approx 0.151$ ,  $\frac{fL}{D}|_1 \approx 27.9$

Then  $\frac{f\Delta L}{D} = \frac{fL}{D}|_1 - \frac{fL}{D}|_c = 27.9 - 1.69 \approx 26.2 = \frac{0.0152L}{0.04}$ , solve  $L_{\text{pipe}} \approx \mathbf{69 \text{ m}}$  Ans.

**9.101** How do the compressible-pipe-flow formulas behave for small pressure drops? Let air at  $20^\circ\text{C}$  enter a tube of diameter 1 cm and length 3 m. If  $\bar{f} = 0.028$  with  $p_1 = 102 \text{ kPa}$  and  $p_2 = 100 \text{ kPa}$ , estimate the mass flow in kg/h for (a) isothermal flow, (b) adiabatic flow, and (c) incompressible flow (Chap. 6) at the entrance density.

**Solution:** For a pressure change of only 2%, all three estimates are nearly the same. Begin by noting that  $fL/D = 0.028(3.0/0.01) = \mathbf{8.4}$ , and  $\rho_1 = 102000/[287(293)] \approx \mathbf{1.213 \text{ kg/m}^3}$ . Take these estimates in order:

$$(a) \text{ Isothermal: } \left(\frac{\dot{m}}{A}\right)^2 = \frac{p_1^2 - p_2^2}{RT[fL/D + 2 \ln(p_1/p_2)]} = \frac{(102000)^2 - (100000)^2}{287(293)[8.4 + 2 \ln(102/100)]} = 569$$

$$\text{Then } \dot{m}/A \approx 23.9, \dot{m}_{\text{isothermal}} = 23.9(\pi/4)(0.01)^2 \approx \mathbf{0.00187 \frac{\text{kg}}{\text{s}}} \text{ Ans. (a)}$$

(b) Adiabatic: Given  $T_o \approx 293 \text{ K}$ ,  $a_o = \sqrt{kRT_o} = 343 \text{ m/s}$ , use Eqs. 9.74 and 9.75:

$$\text{Converges to } \frac{V_1}{V_2} = 0.9803, V_1^2 = \frac{(343)^2[1 - (0.9803)^2]}{1.4(8.4) + 2.4 \ln(1.02)} = 388, \text{ or } V_1 \approx 19.7 \text{ m/s}$$

$$\text{Then } \dot{m} = \rho_1 AV_1 = 1.213(\pi/4)(0.01)^2(19.7) = \mathbf{0.00188 \text{ kg/s}} \text{ Ans. (b)}$$

(c) Incompressible:  $\Delta p = (fL/D)(\rho/2)V^2$ , or  $2000 = (8.4)(1.213/2)V^2$ , or  $V \approx 19.8 \text{ m/s}$ .

$$\text{Then } \dot{m}_{\text{incompressible}} = \rho AV = 1.213(\pi/4)(0.01)^2(19.8) \approx \mathbf{0.00189 \text{ kg/s}} \text{ Ans. (c)}$$

**9.102** Air at 550 kPa and  $100^\circ\text{C}$  enters a smooth 1-m-long pipe and then passes through a second smooth pipe to a 30-kPa reservoir, as in Fig. P9.102. Using the Moody chart to compute  $f$ , estimate the mass flow through this system. Is the flow choked?

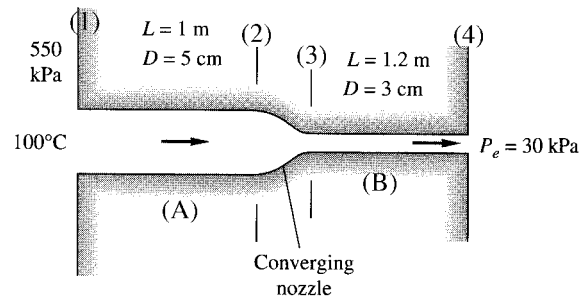


Fig. P9.102

**Solution:** Label the pipes “A” and “B” as shown. Given  $(L/D)_A = 20$  and  $(L/D)_B = 40$ . Label the relevant sections 1, 2, 3, 4 as shown. With  $p_{o1}/p_e = 550/30 = 18.3$ , these short pipes are *sure* to be choked, with an exit pressure  $p_4$  much larger than 30 kPa. One way is to guess  $Ma_1$  and work your way through to section 4 to require  $Ma_4 = 1.0$  (choked). Take a constant average viscosity  $\mu = 2.2E-5$  kg/m·s. Assume isentropic expansion to section 1 from the reservoir, frictional flow through pipe A, isentropic expansion from 2 to 3, and a second frictional flow through pipe B to section 4. The correct solution is  $Ma_1 \approx 0.18$ :

$$Ma_1 = 0.18, \quad T_1 = \frac{373 \text{ K}}{1 + 0.2(0.18)^2} = 371 \text{ K}, \quad p_1 = \frac{450000 \text{ Pa}}{[1 + 0.2(0.18)^2]^{3.5}} = 440000 \text{ Pa},$$

$$\rho_1 = \frac{p_1}{RT_1} = \frac{440000}{287(371)} = 4.14 \frac{\text{kg}}{\text{m}^3}, \quad V_1 = Ma_1 \sqrt{kRT_1} = 69.5 \frac{\text{m}}{\text{s}}, \quad Re_1 = \frac{\rho_1 V_1 D_A}{\mu} = 653,000$$

$$\text{Moody chart: } f_A \approx 0.0125; \quad \text{Table B.3: } \left. \frac{fL}{D} \right|_1 = 18.54, \quad \left. \frac{fL}{D} \right|_2 = 18.54 - 0.0125(20) = 18.29$$

Pipe A is so short that the Mach number hardly changes. At  $(fL/D)_2 = 18.29$ , read  $Ma_2 \approx 0.181$ . Now, at  $Ma_2 = 0.181$ , determine  $A_2/A^* = 3.26$ , hence  $A_3/A^* = (3.26)(3/5)^2 = 1.17$ , read  $Ma_3 = 0.613$  and  $(fL/D)_3 = 0.442$ . Stop to calculate  $\rho_3 = 3.49$  kg/m<sup>3</sup>,  $V_3 = 229$  m/s,  $Re_B = 1.09E6$ , from the Moody chart,  $f_B = 0.0115$ . Then  $(fL/D)_4 = 0.442 - 0.0115(40) = -0.018$ . (?) This last value should have been exactly  $(fL/D)_4 = 0$  if the exit Mach number is 1.0. But we were close. The mass flow follows from the conditions at section 1:

$$\dot{m} = \rho_1 A_1 V_1 = \left( 4.14 \frac{\text{kg}}{\text{m}^3} \right) \left[ \frac{\pi}{4} (0.05 \text{ m})^2 \right] \left( 69.5 \frac{\text{m}}{\text{s}} \right) \approx \mathbf{0.565 \frac{\text{kg}}{\text{s}}} \quad \text{Ans.}$$

EES can barely improve upon this:  $Ma_1 = \mathbf{0.1792}$ , yielding a mass flow of  $\mathbf{0.5616}$  kg/s. The exit pressure is  $p_4 = 201$  kPa, far larger than the receiving reservoir pressure of 30 kPa.

**9.103** Natural gas, with  $k \approx 1.3$  and a molecular weight of 16, is to be pumped through 100 km of 81-cm-diameter pipeline. The downstream pressure is 150 kPa. If the gas enters at 60°C, the mass flow is 20 kg/s, and  $\bar{f} = 0.024$ , estimate the required entrance pressure for (a) isothermal flow and (b) adiabatic flow.

**Solution:** The gas constant is  $R_{\text{gas}} = 8314/16 \approx 520 \text{ J/kg}\cdot\text{K}$ . First use Eq. 9.73:

$$\begin{aligned} \text{(a) Isothermal: } \left(\frac{\dot{m}}{A}\right)^2 &= \left[\frac{20}{(\pi/4)(0.81)^2}\right]^2 = \frac{p_1^2 - p_2^2}{RT[fL/D + 2 \ln(p_1/p_2)]} \\ &= \frac{p_1^2 - (150000)^2}{520(333)[2963 + 2 \ln(p_1/150000)]}, \end{aligned}$$

solve for  $p_1 \approx 892 \text{ kPa}$  Ans. (a)

Part (a) indicates a low inlet Mach number,  $\approx 0.02$ , so  $T_e \approx T_o$ ,  $a_e \approx a_o \approx 475 \text{ m/s}$ . Then use Eqs. (9.74) and (9.75)—the latter simply indicates that the bracket  $[\ ] \approx 1.000$ . Then

$$\frac{V_1}{V_2} \approx \frac{p_2}{p_1} \quad \text{and} \quad V_1^2 = \frac{a_o^2[1 - (V_1/V_2)^2]}{k(fL/D) + (k+1)\ln(V_2/V_1)} = \frac{(475)^2[1 - (V_1/V_2)^2]}{1.3(2963) + 2.3 \ln(V_2/V_1)},$$

plus  $\rho_1 V_1 = \rho_2 V_2 = \dot{m}/A = 38.81 \text{ kg/s}\cdot\text{m}^2$ . Solve for  $V_1 = 7.54 \frac{\text{m}}{\text{s}}$ ,  $\rho_1 = 5.15 \frac{\text{kg}}{\text{m}^3}$ ,

$$p_1 = \rho_1 R T_1 = 5.15(520)(333) \approx 892 \text{ kPa}$$

**9.104** A tank of oxygen (Table A.4) at 20°C is to supply an astronaut through an umbilical tube 12 m long and 1.5 cm in diameter. The exit pressure in the tube is 40 kPa. If the desired mass flow is 90 kg/h and  $f = 0.025$ , what should be the air pressure in the tank?

**Solution:** For oxygen, from Table A.4, take  $k = 1.40$  and  $R = 260 \text{ J/kg}\cdot\text{K}$ . Given  $T_o = 293 \text{ K}$  and  $f\Delta L/D = (0.025)(12 \text{ m})/(0.015 \text{ m}) = 20$ . Use isothermal flow, Eq. (9.73), as a first estimate:

$$\begin{aligned} \left(\frac{\dot{m}}{A}\right)^2 &= \left[\frac{90/3600 \text{ kg/s}}{(\pi/4)(0.015 \text{ m})^2}\right]^2 = \frac{p_1^2 - p_2^2}{RT[fL/D + 2 \ln(p_1/p_2)]} \\ &= \frac{p_1^2 - (40000)^2}{(260)(293)[20 + 2 \ln(p_1/40000)]} \quad \text{Solve for } p_1 \approx 192 \text{ kPa} \end{aligned}$$

This is a very good estimate of  $p_1$ , but we really need *adiabatic* flow, Eqs. (9.66) and (9.68a). First estimate the entrance Mach number from  $p_1$  and  $T_1 \approx T_o$ :

$$\rho_1 \approx \frac{p_1}{RT_o} = \frac{192000}{260(293)} \approx 2.52 \frac{\text{kg}}{\text{m}^3}, \quad \dot{m} = \frac{90 \text{ kg}}{3600 \text{ s}} = \rho_1 A V_1 \approx (2.52) \frac{\pi}{4} (0.015 \text{ m})^2 V_1$$

$$\text{solve } V_1 \approx 56 \text{ m/s}, \quad a_1 \approx \sqrt{kRT_o} = \sqrt{1.4(260)(293)} \approx 327 \text{ m/s}, \quad Ma_1 \approx \frac{56}{327} \approx 0.17$$

We can guess  $Ma_1$  around 0.17, find  $(fL^*/D)_1$ , subtract  $(f\Delta L/D) = 20$ , find the new Mach number and  $p^*$ , thence back up to obtain  $p_1$ . Iterate to convergence. For example:

$$Ma_1 = 0.17, (fL^*/D)_1 = 21.12, p_1/p^* = 6.43, (fL^*/D)_2 = 21.12 - 20 = 1.12, \text{ compute}$$

$$Ma_2 = 0.49, p_2/p^* = 2.16, p^* = 40000/2.16 = 18500 \text{ Pa}, p_1 = 6.43(18500) = 119000 \text{ Pa},$$

$$T_1 = T_o/[1 + 0.2(0.17)^2] = 291 \text{ K}, \rho_1 = 1.57 \text{ kg/m}^3, \text{ mass flow} = \rho_1 A V_1 \approx 55 \text{ kg/h}$$

The mass flow is too low, so try  $Ma_1$  a little higher. The iteration is remarkably sensitive to Mach number because the correct exit flow is close to sonic. The final converged solution is

$$Ma_1 = 0.1738, Ma_2 = 0.7792, \quad p_1 = \mathbf{189.4 \text{ kPa}} \quad \text{Ans.}$$

This problem is clearly well suited to EES, which converges rapidly to the final pressure.

**9.105** Air enters a 5-cm-diameter pipe at  $p_1 = 200 \text{ kPa}$  and  $T_1 = 350 \text{ K}$ . The downstream receiver pressure is  $74 \text{ kPa}$  and the friction factor is  $0.02$ . If the exit is choked, what is (a) the length of the pipe, and (b) the mass flow? (c) If  $p_1$ ,  $T_1$  and  $p_{\text{receiver}}$  stay the same, what pipe length will cause the mass flow to increase by 50% over (b)? *Hint*: In (c) the exit pressure does not equal receiver pressure.

**Solution:** (a) Here the exit pressure *does* equal the receiver pressure:

$$\frac{p_1}{p^*} = \frac{200}{74} = 2.70; \quad \text{Table B.3: read } Ma_1 = 0.399, f \frac{L}{D} = 2.327,$$

$$\therefore L = \frac{2.327(0.05)}{0.02} = \mathbf{5.82 \text{ m}} \quad \text{Ans. (a)}$$

$$(b) V = Ma_1 a_1 = 0.399 \sqrt{1.4(287)(350)} = 150 \frac{\text{m}}{\text{s}}, \quad \rho_1 = \frac{p_1}{RT_1} = \frac{200000}{287(350)} = 1.99 \frac{\text{kg}}{\text{m}^3}$$

$$\dot{m} = \rho_1 A_1 V_1 = (1.99) \frac{\pi}{4} (0.05)^2 (150) = \mathbf{0.585 \frac{\text{kg}}{\text{s}}} \quad \text{Ans. (b)}$$



(c) If mass flow increases 50%, and  $\rho_1$  and  $A_1$  are the same, then  $V_1$  and  $Ma_1$  must increase 50%, hence we can immediately calculate the new Mach number:

$$Ma_{1,new} = 1.5(0.399) = 0.599;$$

$$\text{Table B.3: } f \frac{L_{new}}{D} = 0.497, \quad L_{new} = 0.497 \frac{0.05}{0.02} = \mathbf{1.24 \text{ m}} \quad \text{Ans. (c)}$$

Check in Table B.3 that the exit pressure is  $p_{new}^* = 113 \text{ kPa} > 74 \text{ kPa} = p_{receiver}$ .

**9.106** Air at 300 K flows through a duct 50 m long with  $\bar{f} = 0.019$ . What is the minimum duct diameter which can carry the flow without choking if the entrance velocity is (a) 50 m/s, (b) 150 m/s, and (c) 420 m/s?

**Solution:** With velocities and speed of sound known, compute  $Ma$  and get  $fL^*/D$ :

$$\text{If } T_1 = 300 \text{ K, } a_1 = \sqrt{1.4(287)(300)} \approx 347 \text{ m/s}$$

$$\text{(a) } V_1 = 50 \text{ m/s, } Ma_1 = \frac{50}{347} = 0.144, \text{ read } \frac{fL^*}{D} \approx 30.6 = \frac{0.019(50)}{D}, \quad D < \mathbf{0.031 \text{ m}} \quad \text{Ans. (a)}$$

$$\text{(b) } V_1 = 150 \text{ m/s, } Ma_1 = 0.432, \text{ read } fL^*/D \approx 1.80 = 0.019(50)/D, \quad D < \mathbf{0.53 \text{ m}} \quad \text{Ans. (b)}$$

$$\text{(c) } V_1 = 420 \text{ m/s, } Ma_1 = 1.21, \text{ read } fL^*/D \approx 0.036 = 0.019(50)/D, \quad D < \mathbf{26 \text{ m}} \quad \text{Ans. (c)}$$

**9.107** A fuel-air mixture, assumed equivalent to air, enters a duct combustion chamber at  $V_1 = 104 \text{ m/s}$  and  $T_1 = 300 \text{ K}$ . What amount of heat addition in kJ/kg will cause the exit flow to be choked? What will be the exit Mach number and temperature if 504 kJ/kg is added during combustion?

**Solution:** Evaluate stagnation temperature and initial Mach number:

$$T_o = T_1 + \frac{V_1^2}{2c_p} = 300 + \frac{(104)^2}{2(1005)} = 305 \text{ K}; \quad Ma_1 = \frac{104}{\sqrt{1.4(287)(300)}} \approx 0.30$$

$$\text{Table B.4: } T_o/T_o^* = 0.3469, \quad \text{hence } T_o^* \approx \left( \frac{305}{0.3469} \right) \approx 880 \text{ K}$$

$$\text{Thus } q_{choke} = c_p \Delta T_{o,max} = 1005(880 - 305) \approx 5.78E5 \text{ J/kg} = \mathbf{578 \text{ kJ/kg}} \quad \text{Ans. (a)}$$

A heat addition of 504 kJ/kg is (just barely) less than maximum, should nearly choke:

$$T_{o2} = T_{o1} + \frac{q}{c_p} = 305 + \frac{540000}{1005} \approx 842 \text{ K}, \quad \frac{T_{o2}}{T_o^*} = \frac{842}{880} = 0.957, \quad \therefore Ma_2 \approx \mathbf{0.78} \quad \text{Ans. (b)}$$

Finally, without using Table B.4,  $T_2 = 842 / [1 + 0.2(0.78)^2] \approx \mathbf{751 \text{ K}}$  Ans. (c)

**9.108** What happens to the inlet flow of Prob. 9.107 if the combustion yields 1500 kJ/kg heat addition and  $p_{o1}$  and  $T_{o1}$  remain the same? How much is the mass flow reduced?

**Solution:** The flow will choke down to a lower mass flow such that  $T_{o2} = T_o^*$ :

$$T_{o2} = T_o^* = 305 + \frac{1500000}{1005} = 1798 \text{ K}, \quad \text{thus } \frac{T_{o1}}{T_o^*} = \frac{305}{1798} = 0.17, \quad Ma_{1,\text{new}} \approx \mathbf{0.198}$$

$$(\dot{m}/A)_{\text{new}} = \rho_1 V_1 = \rho_1 a_1 Ma_1 = \rho_o a_o Ma_1 / [1 + 0.2 Ma_1^2]^3 \quad \text{if } p_{o1}, T_{o1}, \rho_{o1} \text{ are the same.}$$

$$\text{Then } \frac{\dot{m}_{\text{new}}}{\dot{m}_{\text{old}}} = \frac{0.198}{0.30} \left[ \frac{1 + 0.2(0.30)^2}{1 + 0.2(0.198)^2} \right] \approx \mathbf{0.68} \quad (\text{about 32\% less flow}) \quad \text{Ans.}$$

**9.109** A jet engine at 7000-m altitude takes in 45 kg/s of air and adds 550 kJ/kg in the combustion chamber. The chamber cross section is 0.5 m<sup>2</sup>, and the air enters the chamber at 80 kPa and 5°C. After combustion the air expands through an isentropic converging nozzle to exit at atmospheric pressure. Estimate (a) the nozzle throat diameter, (b) the nozzle exit velocity, and (c) the thrust produced by the engine.

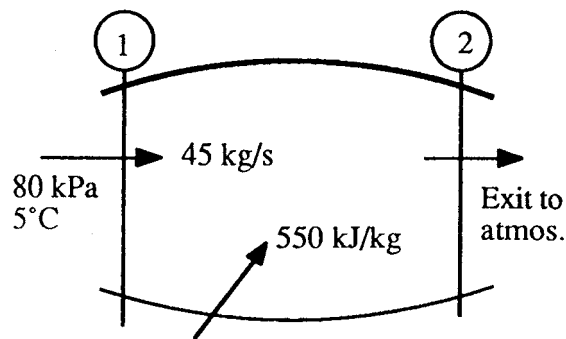


Fig. P9.109

**Solution:** At 7000-m altitude,  $p_a = 41043 \text{ Pa}$ ,  $T_a = 242.66 \text{ K}$  to use as exit conditions.

$$\rho_1 = \frac{p_1}{RT_1} = \frac{80000}{287(278)} = 1.00 \frac{\text{kg}}{\text{m}^3}, \quad \dot{m} = 45 \frac{\text{kg}}{\text{s}} = \rho AV = 1.00(0.5)V_1, \quad V_1 = 90 \text{ m/s}$$

$$\text{Ma}_1 = \frac{90}{\sqrt{1.4(287)(278)}} = \mathbf{0.27}, \quad \text{Table B.4: } T_{o1}/T_o^* \approx 0.29,$$

$$T_{o1} = 278 + (90)^2/[2(1005)] \approx 282 \text{ K}, \quad \therefore T_o^* = 282/0.29 \approx \mathbf{973 \text{ K}}$$

$$\text{Add heat: } T_{o2} = 282 + \frac{550000}{1005} \approx 829 \text{ K}, \quad \text{thus } \frac{T_{o2}}{T_o^*} = \frac{829}{973} \approx 0.85, \quad \text{read } \text{Ma}_2 \approx \mathbf{0.63}$$

$$\text{also read } p_1/p^* \approx 2.18, \quad p_2/p^* \approx 1.54, \quad \therefore p_2 = 80(1.54/2.18) \approx 57 \text{ kPa},$$

$$p_{o2} = p_2 \left[ 1 + 0.2 \text{Ma}_2^2 \right]^{3.5} = 57 [1 + 0.2(0.63)^2]^{3.5} \approx 74 \text{ kPa}$$

With data now known at section 2, expand isentropically to the atmosphere:

$$\frac{p_e}{p_{o2}} = \frac{41043}{57000} = 0.72 = \left[ 1 + 0.2 \text{Ma}_e^2 \right]^{-3.5}, \quad \text{solve } \text{Ma}_e = 0.70, \quad \frac{T_e}{T_{o2}} = \frac{T_e}{829} = 0.910,$$

$$\text{Solve } T_e \approx 755 \text{ K}, \quad \rho_e = p_e/RT_e \approx 0.189 \text{ kg/m}^3, \quad a_e = \sqrt{kRT_e} = 551 \text{ m/s},$$

$$V_e = \text{Ma}_e a_e \approx \mathbf{385 \text{ m/s}} \quad \text{Ans. (b)}$$

$$\dot{m} = 45 = 0.189(385) \frac{\pi}{4} D_e^2, \quad \text{solve } D_e \approx \mathbf{0.89 \text{ m}} \quad \text{Ans. (a)}$$

$$\text{Finally, if } p_e = p_{\text{atm}}, \quad \text{from Prob. 3.68, } F_{\text{thrust}} = \dot{m}V_e = 45(385) \approx \mathbf{17300 \text{ N}} \quad \text{Ans. (c)}$$

**9.110** Compressible pipe flow with heat addition, Sec. 9.8, assumes constant momentum ( $p + \rho V^2$ ) and constant mass flow but variable stagnation enthalpy. Such a flow is often called *Rayleigh flow*, and a line representing all possible property changes on an temperature-entropy chart is called a *Rayleigh line*. Assuming air passing through the flow state  $p_1 = 548 \text{ kPa}$ ,  $T_1 = 588 \text{ K}$ ,  $V_1 = 266 \text{ m/s}$ , and  $A = 1 \text{ m}^2$ , draw a Rayleigh curve of the flow for a range of velocities from very low ( $\text{Ma} \ll 1$ ) to very high ( $\text{Ma} \gg 1$ ). Comment on the meaning of the maximum-entropy point on this curve.

**Solution:** First evaluate the Mach number and density at the reference state:

$$\rho = \frac{p}{RT} = \frac{548000}{287(588)} \approx 3.25 \frac{\text{kg}}{\text{m}^3}; \quad \text{Ma} = \frac{V}{\sqrt{kRT}} = \frac{266}{\sqrt{1.4(287)(588)}} = 0.55$$

Our basic algebraic equations are then:

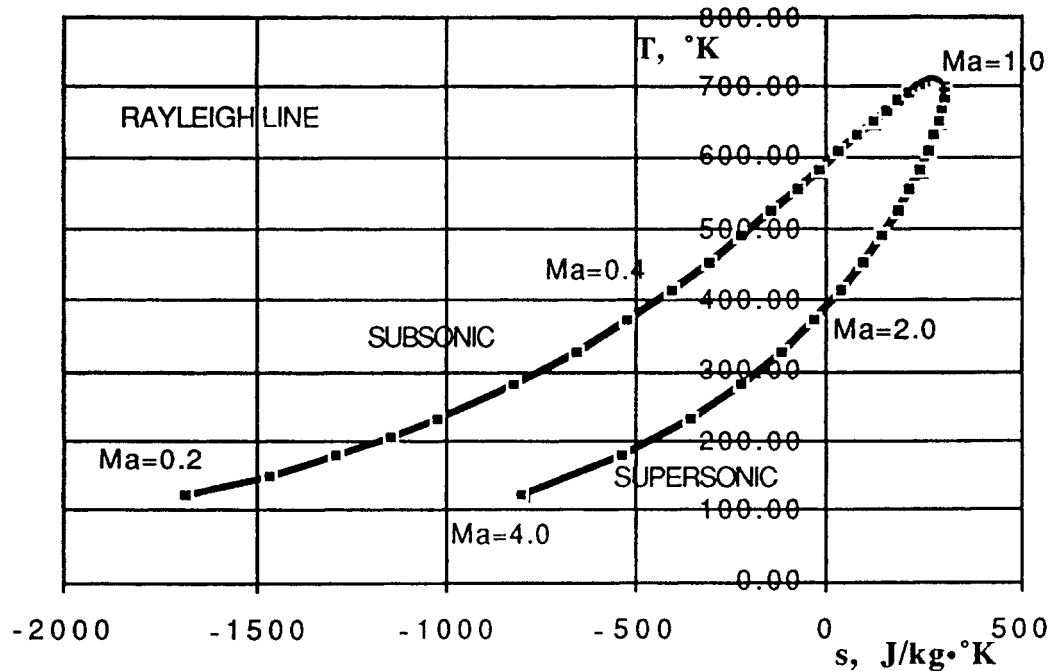
$$\text{Momentum: } \mathbf{p + \rho V^2 = 548000 + 3.25(266)^2 = 778000} \quad \text{(a)}$$

$$\text{Continuity: } \rho V = 3.25(266), \quad \text{or: } \rho = \mathbf{864/V} \quad \text{(b)}$$

$$\text{Entropy: } \mathbf{s = 718 \ln(T/588) - 287 \ln(\rho/3.25)} \quad \text{(c)}$$

We simply let  $V$  vary from, say, 10 m/s to 800 m/s, compute  $\rho$  from (b),  $p$  from (a),  $T = p/\rho T$ , and  $s$  from (c), then plot  $T$  versus  $s$ . [We have arbitrarily set  $s = 0$  at state 1.]

The result of this exercise forms the **Rayleigh Line** for this flow, shown below. Some Mach numbers are listed, subsonic on the top, supersonic on the bottom, and exactly **sonic** at the right-hand (maximum-entropy) side. *Ans.*



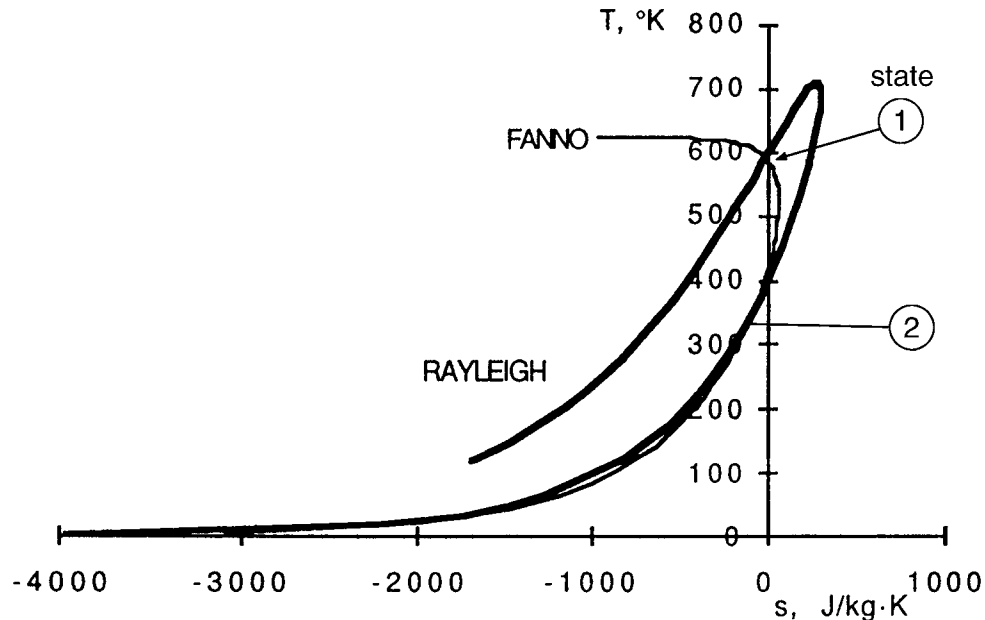
**9.111** Add to your Rayleigh line of Prob. 9.110 a Fanno line (see Prob. 9.94) for stagnation enthalpy equal to the value associated with state 1 in Prob. 9.110. The two curves will intersect at state 1, which is subsonic, and also at a certain state 2, which is supersonic. Interpret these two cases vis-a-vis Table B.2.

**Solution:** For  $T_1 = 588$  K and  $V_1 = 266$  m/s, the stagnation temperature is

$$T_o = T_1 + \frac{V^2}{2c_p} = 588 + \frac{(266)^2}{2(1005)} \approx \mathbf{623 \text{ K}}; \quad \text{Elsewhere, } T = 623 - \frac{V^2}{2(1005)} \quad (\mathbf{d})$$

Also, from Prob. 9.110,  $\rho = 864/V$  (b) and  $s = 728 \ln\left(\frac{T}{588}\right) - 287 \ln\left(\frac{\rho}{3.25}\right)$  (c)

By varying  $V$  and computing  $(T, \rho, s)$  from (b, c, d), we plot the Fanno line and add it to the previous Rayleigh line. The composite graph is as follows:



The subsonic intersection is state 1,  $Ma_1 \approx 0.55$ ,  $T_2 \approx 588$  K, and the supersonic intersection is at  $Ma_2 \approx 2.20$ , where, for example,  $T_2 \approx 316$  K. Also,  $s_1 > s_2$ . These two points thus correspond to the two sides of a **normal shock wave**, where “2” is the supersonic upstream and “1” the subsonic downstream condition. We may check these results in Table B-2, where, at  $Ma \approx 2.20$ , the temperature ratio across the shock is 1.857—for *our* calculations, this ratio is  $588 \text{ K}/316 \text{ K} \approx 1.86$  (agreement would be perfect if we kept more significant figures). Shock flow satisfies **all** the four equations of Rayleigh and Fanno flow combined—continuity, momentum, energy, and the equation of state.

**9.112** Air enters a duct subsonically at section 1 at 1.2 kg/s. When 650 kW of heat is added, the flow chokes at the exit at  $p_2 = 95$  kPa and  $T_2 = 700$  K. Assuming frictionless heat addition, estimate (a) the velocity; and (b) the stagnation pressure at section 1.

**Solution:** Since the exit is choked,  $p_2 = p^*$  and  $T_2 = T^*$  and, of course,  $Ma_2 = 1.0$ . Then

$$V_2 = V^* = \sqrt{kRT^*} = \sqrt{1.4(287)(700)} \approx 530 \text{ m/s}, \quad \text{and} \quad q = \dot{Q}/\dot{m} = \frac{650}{1.2} = 542 \frac{\text{kJ}}{\text{kg}}$$

$$\text{Also, } T_o^* = 1.2T_2 = 1.2(700) = 840 \text{ K; hence } T_{o1} = 840 - \frac{542000}{1005} \approx 301 \text{ K}$$

Then  $T_{o1}/T_o^* = \frac{301}{840} = 0.358$ ; Table B.4: read  $Ma_1 \approx \mathbf{0.306}$ , read  $V_1/V^* \approx 0.199$

So  $V_1 = 530(0.199) \approx \mathbf{105 \text{ m/s}}$  *Ans. (a)*

Also read  $p_{o1}/p_o^* \approx 1.196$ , where  $p_o^* = p_2/0.5283 \approx 180 \text{ kPa}$ ,

Hence  $p_{o1} \approx 1.196(180) \approx \mathbf{215 \text{ kPa}}$  *Ans. (b)*

**9.113** Air enters a constant-area duct at  $p_1 = 90 \text{ kPa}$ ,  $V_1 = 520 \text{ m/s}$ , and  $T_1 = 558^\circ\text{C}$ . It is then *cooled* with negligible friction until it exists at  $p_2 = 160 \text{ kPa}$ . Estimate (a)  $V_2$ ; (b)  $T_2$ ; and (c) the total amount of cooling in  $\text{kJ/kg}$ .

**Solution:** We have enough information to estimate the inlet  $Ma_1$  and go from there:

$$a_1 = \sqrt{1.4(287)(558 + 273)} = 578 \frac{\text{m}}{\text{s}}, \quad \therefore Ma_1 = \frac{520}{578} \approx \mathbf{0.90}, \quad \text{read } \frac{p_1}{p^*} = 1.1246,$$

$$\text{or } p^* = \frac{90}{1.1246} = 80.0 \text{ kPa}, \quad \text{whence } \frac{p_2}{p^*} = \frac{160}{80} \approx 2.00, \quad \text{read } Ma_2 \approx \mathbf{0.38},$$

$$\text{read } T_2/T^* = 0.575, \quad V_2/V^* = 0.287, \quad T_{o2}/T_o^* \approx 0.493$$

We have to back off to section 1 to determine the critical (\*) values of  $T$ ,  $V$ ,  $T_o$ :

$$Ma_1 = 0.9, \quad T_1/T^* = 1.0245, \quad T^* = \frac{558 + 273}{1.0245} = 811 \text{ K}, \quad T_2 = 0.575(811) \approx \mathbf{466 \text{ K}} \quad \text{Ans. (b)}$$

$$\text{also, } V_1/V^* = 0.911, \quad V^* = \frac{520}{0.911} = 571 \text{ m/s}, \quad \text{so } V_2 = 0.287(571) \approx \mathbf{164 \text{ m/s}} \quad \text{Ans. (a)}$$

$$T_{o1}/T_o^* = 0.9921, \quad \text{where } T_{o1} = T_1 + V_1^2/2c_p = 966 \text{ K}, \quad T_o^* = \frac{966}{0.9921} = 973 \text{ K}$$

$$\text{Finally, } T_{o2} = 0.493(973) = 480 \text{ K},$$

$$\mathbf{q_{cooling}} = c_p \Delta T_o = 1.005(966 - 480) \approx \mathbf{489 \frac{\text{kJ}}{\text{kg}}} \quad \text{Ans. (c)}$$

**9.114** We have simplified things here by separating friction (Sec. 9.7) from heat addition (Sec. 9.8). Actually, they often occur together, and their effects must be evaluated simultaneously. Show that, for flow with friction *and* heat transfer in a constant-diameter pipe, the continuity, momentum, and energy equations may be combined into the following differential equation for Mach-number changes:

$$\frac{dMa^2}{Ma^2} = \frac{1 + kMa^2}{1 - Ma^2} \frac{dQ}{c_p T} + \frac{kMa^2[2 + (k-1)Ma^2]}{2(1 - Ma^2)} \frac{f dx}{D}$$

where  $dQ$  is the heat added. A complete derivation, including many additional combined effects such as area change and mass addition, is given in chap. 8 of Ref. 8.

**Solution:** This derivation is algebraically complicated and is left as an exercise for the student. One can set good problems using this equation for studies in combined friction and heat transfer, using the Reynolds analogy between friction and heat transfer [Ref. 8].

**9.115** Air flows subsonically in a duct with negligible friction. When heat is added in the amount of 948 kJ/kg, the pressure drops from  $p_1 = 200$  kPa to  $p_2 = 106$  kPa. Using one-dimensional theory, estimate (a)  $Ma_1$ ; (b)  $T_1$ ; and (c)  $V_1$ .

**Solution:** We need one missing piece of information:  $T_{o1} = 305$  K. Then guess  $Ma_1$ :

$$Ma_1 \stackrel{?}{=} 0.2: \text{ read } T_{o1}/T_o^* = 0.1736, p_1/p^* = 2.2727, \text{ then } p_2/p^* = 2.2727 \left( \frac{106}{200} \right) \approx 1.205$$

$$\text{then read } Ma_2 \approx 0.84, T_{o2}/T_o^* = 0.978, T_{o2} = 305 \left( \frac{0.978}{0.1736} \right) \approx 1719 \text{ K, compute}$$

$$q = c_p \Delta T_o = 1.005(1719 - 305) \approx 1420 \text{ kJ/kg (too much, } >948 \text{ as given)}$$

$$Ma_1 \stackrel{?}{=} 0.3: \text{ gives } p_2/p^* = 1.129, Ma_2 \approx 0.90, T_{o2} \approx 887 \text{ K, } q = c_p \Delta T_o = 585 \frac{\text{kJ}}{\text{kg}} (<948)$$

$$\text{Converges to } Ma_1 = \mathbf{0.24} \quad \text{Ans. (a)} \quad T_1 = \mathbf{302 \text{ K}} \quad \text{Ans. (b)}$$

$$T_{o2} \approx 1247 \text{ K, } q = 947 \frac{\text{kJ}}{\text{kg}} (\text{OK})$$

$$\text{Also, } V_1 = Ma_1 \sqrt{kRT_1} = 0.24 \sqrt{1.4(287)(302)} \approx \mathbf{84 \text{ m/s}} \quad \text{Ans. (c)}$$

**9.116** An observer at sea level does not hear an aircraft flying at 12000 ft standard altitude until it is 5 statute miles past her. Estimate the aircraft speed in ft/sec.

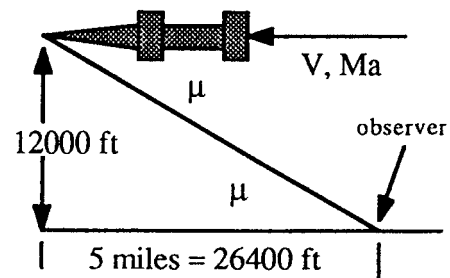


Fig. P9.116

**Solution:** The average temperature over this range is 498°R, hence

$$\bar{a} = \sqrt{kRT} = \sqrt{1.4(1717)(498)} = 1094 \text{ ft/s}, \quad \text{and} \quad \tan \mu = \frac{12000}{26400} = 0.455,$$

$$\text{or: } \mu \approx 24.4^\circ, \quad \text{Ma}_{\text{plane}} = \csc \mu \approx 2.42, \quad \mathbf{V}_{\text{plane}} = 2.42(1094) \approx \mathbf{2648} \frac{\text{ft}}{\text{s}} \quad \text{Ans.}$$

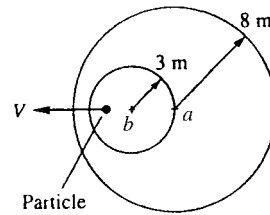
**9.117** An observer at sea level does not hear an aircraft flying at 6000-m standard altitude until 15 seconds after it has passed overhead. Estimate the aircraft speed in m/s.

**Solution:** This is a messier version of Prob. 9.116 above. The average temperature over this range of altitudes is 268 K. Then the appropriate Mach-wave geometry is

$$\mu = \tan^{-1} \left( \frac{6000}{15V} \right) = \sin^{-1} \left( \frac{1}{\text{Ma}} \right) = \sin^{-1} \left( \frac{a}{V} \right), \quad \text{where } a = \sqrt{1.4(287)(268)} \approx 328 \text{ m/s}$$

$$\text{Solve iteratively for } \mu \approx 35^\circ, \quad \text{Ma} \approx 1.74, \quad \mathbf{V}_{\text{plane}} = 1.74(328) \approx \mathbf{572} \frac{\text{m}}{\text{s}} \quad \text{Ans.}$$

**9.118** A particle moving at uniform velocity in sea-level standard air creates the two disturbance spheres shown in Fig. P9.118. Compute the particle velocity and Mach number.



**Fig. P9.118**

**Solution:** If point “a” represents  $t = 0$  units, the particle reaches point “b” in  $8 - 3 = 5$  units. But the distance from  $a$  to  $b$  is only 3 units. Therefore the (subsonic) Mach number is

$$\text{Ma} = \frac{V \Delta t}{a \Delta t} = \frac{3 \text{ units}}{5 \text{ units}} \approx \mathbf{0.6} \quad \text{Ans. (a)}$$

$$\mathbf{V}_{\text{particle}} = \text{Ma}(a) = 0.6 \sqrt{1.4(287)(288 \text{ K})} \approx \mathbf{204 \text{ m/s}} \quad \text{Ans. (b)}$$



**9.119** The particle in Fig. P9.119 is moving supersonically in sea-level standard air. From the two disturbance spheres shown, compute the particle (a) Mach number; (b) velocity; and (c) Mach angle.

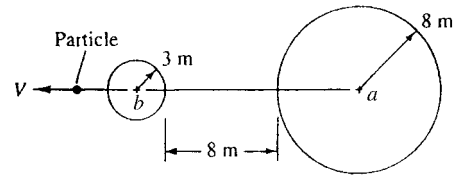


Fig. P9.119

**Solution:** If point “a” represents  $t = 0$  units, the particle reaches point “b” in  $8 - 3 = 5$  units. But the distance from  $a$  to  $b$  is  $8 + 8 + 3 = 19$  units. Therefore the Mach number is

$$\text{Ma} = \frac{V \Delta t}{a \Delta t} = \frac{19 \text{ units}}{5 \text{ units}} \approx 3.8 \quad \text{Ans. (a)} \quad \mu_{\text{wave}} = \sin^{-1}\left(\frac{1}{3.8}\right) \approx 15.3^\circ \quad \text{Ans. (c)}$$

$$V_{\text{particle}} = \text{Ma}(a) = 3.8\sqrt{1.4(287)(288 \text{ K})} \approx 1290 \text{ m/s} \quad \text{Ans. (b)}$$

**9.120** The particle in Fig. P9.120 is moving in sea-level standard air. From the two disturbance spheres shown, estimate (a) the position of the particle at this instant; and (b) the temperature in  $^\circ\text{C}$  at the front stagnation point of the particle.

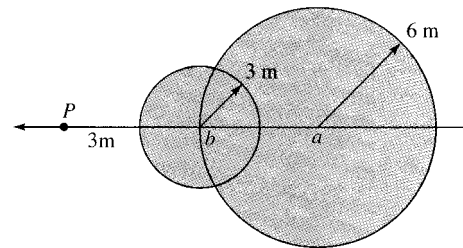


Fig. P9.120

**Solution:** Given sea-level temperature = 288 K. If point “a” represents  $t = 0$  units, the particle reaches point “b” in  $6 - 3 = 3$  units. But the distance from  $a$  to  $b$  is 6 units. Therefore the particle Mach number is

$$\text{Ma} = \frac{6}{3} = 2.0, \quad \therefore T_{\text{stagnation}} = T_o = 288[1 + 0.2(2.0)^2] \approx 518 \text{ K} \quad \text{Ans. (b)}$$

$$\mu = \sin^{-1}\left(\frac{1}{2}\right) = 30^\circ, \quad \text{and the particle is at point “P” at 6 meters ahead of “b.”} \quad \text{Ans. (a)}$$

**9.121** A thermistor probe, in the shape of a needle parallel to the flow, reads a static temperature of  $-25^\circ\text{C}$  when inserted in the stream. A conical disturbance of half-angle  $17^\circ$  is formed. Estimate (a) the Mach number; (b) the velocity; and (c) the stagnation temperature of the stream.

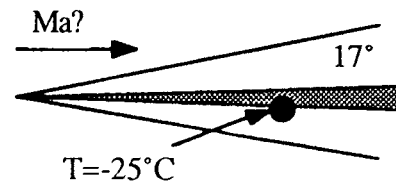


Fig. P9.121

**Solution:** If the needle is “very thin,” it reads the *stream* static temperature,  $T_\infty \approx -25^\circ\text{C} = 248\text{ K}$ . We are given the Mach angle,  $\mu = 17^\circ$ , so everything else follows readily:

$$\text{Ma}_\infty = \csc\mu = \csc 17^\circ = \mathbf{3.42} \quad \text{Ans. (a)}$$

$$T_0 = 248[1 + 0.2(3.42)^2] = 828\text{ K} = \mathbf{555^\circ\text{C}} \quad \text{Ans. (c)}$$

$$U_\infty = \text{Ma}_\infty a_\infty = 3.42\sqrt{1.4(287)(248)} = 3.42(316) \approx \mathbf{1080\text{ m/s}} \quad \text{Ans. (b)}$$

**9.122** Supersonic air takes a  $5^\circ$  compression turn, as in Fig. P9.122. Compute the downstream pressure and Mach number and wave angle, and compare with small-disturbance theory.

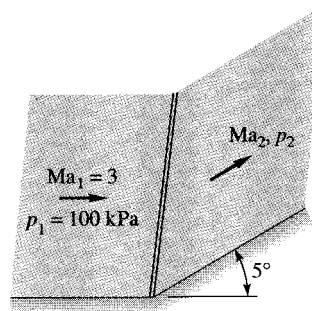


Fig. P9.122

**Solution:** From Fig. 9.23,  $\beta \approx 25^\circ$ , and we can iterate Eq. (9.86) to a closer estimate:

$$\text{Ma}_1 = 3.0, \theta = 5^\circ, \text{ compute } \beta = \mathbf{23.133^\circ},$$

$$p_2/p_1 = 1.454, \quad \mathbf{p_2 = 145.4\text{ Pa}}$$

From Eq. 9.83f, compute  $\mathbf{Ma_2 = 2.750}$  Ans. (a, b, c) Exact oblique shock theory.

This is a small deflection. The linear theory of Eqs. 9.88 and 9.89 is reasonably accurate:

$$\mu = \sin^{-1}\left(\frac{1}{3}\right) = 19.47^\circ, \quad \sin\beta = \sin\mu + \frac{(k+1)\tan\theta}{4\cos\mu} + \dots = \frac{1}{3} + 0.0557 + \dots \approx 0.389$$

$$\text{or: } \beta_{\text{linear}} \approx \mathbf{22.9^\circ} \text{ (1\% low)} \quad \frac{\Delta p}{p_1} \approx \frac{1.4(3)^2}{\sqrt{3^2 - 1}} \tan 5^\circ = 0.39,$$

$$p_2 \approx 100(1.39) \approx \mathbf{139\text{ kPa}} \text{ (4\% low)}$$

**9.123** Modify Prob. 9.122 as follows: Let the  $5^\circ$  turn be in the form of five separate compression turns of  $1^\circ$  each. Compute the final Mach number and pressure, and compare the pressure with an isentropic expansion to the same final Mach number.

**Solution:** Even the above  $5^\circ$  turn in 9.122 is nearly isentropic, but let's do it again:

Turn angle:	$0^\circ\text{--}1^\circ$	$1^\circ\text{--}2^\circ$	$2^\circ\text{--}3^\circ$	$3^\circ\text{--}4^\circ$	$4^\circ\text{--}5^\circ$
Wave angle $\beta$ :	$20.158^\circ$	$20.514^\circ$	$20.876^\circ$	$21.245^\circ$	$21.620^\circ$
Ma-downstream:	2.949	2.898	2.849	2.800	<b>2.753</b> Ans.
Pressure ratio:	1.0802	1.0790	1.0778	1.0766	1.0754

The total pressure ratio across the shock is

$$p_{\text{final}}/p_{\infty} = (1.0802)(1.0790)(1.0778)(1.0766)(1.0754) \approx \mathbf{1.4544} \quad \text{Ans. (exact)}$$

$$p_{\text{isentropic}}/p_{\infty} = \frac{(p/p_o)_{\text{final}}}{(p/p_o)_{\text{stream}}} = \left[ \frac{1 + 0.2(2.753)^2}{1 + 0.2(3.0)^2} \right]^{-3.5} \approx \mathbf{1.4547} \quad \text{Ans. (nearly the same)}$$

**9.124** When a sea-level air flow approaches a ramp of angle  $20^\circ$ , an oblique shock wave forms as in Figure P9.124. Calculate (a)  $Ma_1$ ; (b)  $p_2$ ; (c)  $T_2$ ; and (d)  $V_2$ .

**Solution:** For sea-level air, take  $p_1 = 101.35$  kPa,  $T_1 = 288.16$  K, and  $\rho_1 = 1.2255$  kg/m<sup>3</sup>. (a) The approach Mach number is determined by the specified angles,  $\beta = 60^\circ$  and  $\theta = 20^\circ$ . From Fig. 9.23 we read that  $Ma_1$  is slightly less than 2.0. More accurately, use Eq. (9.86):

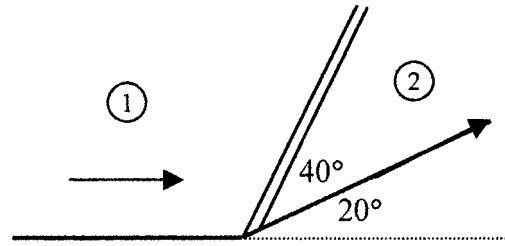


Fig. P9.124

$$\tan \theta = \frac{2 \cot \beta (Ma_1^2 \sin^2 \beta - 1)}{Ma_1^2 (k + \cos 2\beta) + 2} \quad \text{for } \theta = 20^\circ \quad \text{and} \quad \beta = 60^\circ$$

Iterate, or use EES, to find that  $Ma_1 = \mathbf{1.87}$ . *Ans. (a)*

(b, c) With  $Ma_1$  known, use Eqs. (9.83a, c) to find  $p_2$  and  $T_2$ :

$$\frac{p_2}{p_1} = \frac{1}{k+1} (2kMa_1^2 \sin^2 \beta - k + 1) = 2.893, \quad p_2 = 2.893(101.35 \text{ kPa}) = \mathbf{293 \text{ kPa}} \quad \text{Ans. (b)}$$

$$\frac{T_2}{T_1} = \left[ 2 + (k-1)Ma_1^2 \sin^2 \beta \right] \frac{2kMa_1^2 \sin^2 \beta - k + 1}{(k+1)^2 Ma_1^2 \sin^2 \beta} = 1.401,$$

$$T_2 = 1.401(288.16 \text{ K}) = \mathbf{404 \text{ K}} \quad \text{Ans. (c)}$$

(d) Finally, to find  $V_2$ , first find  $V_1$  from the approach Mach number, then use Eq. (9.83b):

$$a_1 = \sqrt{kRT_1} = \sqrt{1.4(287)(288.16)} = 340 \frac{\text{m}}{\text{s}}, \quad V_1 = a_1 Ma_1 = (340)(1.87) = 636 \frac{\text{m}}{\text{s}}$$

$$\frac{V_2}{V_1} = \frac{\cos \beta}{\cos(\beta - \theta)} = \frac{\cos 60^\circ}{\cos 40^\circ} = 0.653, \quad V_2 = 0.653(636 \text{ m/s}) = \mathbf{415 \frac{m}{s}} \quad \text{Ans. (d)}$$

**9.125** Show that, as the upstream Mach number approaches infinity, the Mach number downstream of an attached oblique-shock wave will have the value

$$\text{Ma}_2 \approx \sqrt{\frac{k-1}{2k \sin^2(\beta-\theta)}}$$

**Solution:** This is a limiting result of Eqs. (9.82) and (9.83f) as  $\text{Ma}_1 \rightarrow \infty$ :

$$\text{Eq. (9.83f): } \lim_{\text{Ma}_1 \rightarrow \infty} \left| \frac{(k-1)\text{Ma}_{1n}^2 + 2}{2k\text{Ma}_{1n}^2 - (k-1)} \right| = \frac{k-1}{2k} = \text{Ma}_{n2}^2 = \text{Ma}_2^2 \sin^2(\beta-\theta)$$

$$\text{Solve for } \mathbf{Ma}_2 = \sqrt{\frac{k-1}{2k \sin^2(\beta-\theta)}} \quad \text{Ans.}$$

**9.126** Consider airflow at  $\text{Ma}_1 = 2.2$ . Calculate, to two decimal places, (a) the deflection angle for which the downstream flow is sonic; and (b) the maximum deflection angle.

**Solution:** We are near the peak of the (invisible) curve for  $\text{Ma}_1 = 2.2$  in Fig. 9.23. The wave angles are  $\approx 65^\circ$ , which we guess for finding the sonic downstream condition:

$\text{Ma}_1 = 2.2$ , guess  $\beta \approx 65^\circ$ , and using Eq. 9.86,

compute  $\theta \approx 26.1^\circ$  and  $\text{Ma}_2 = 0.92$  (not quite sonic)

Converges to  $\text{Ma}_2 = 1.000$  when  $\beta \approx 61.9^\circ$  and  $\theta \approx \mathbf{25.9^\circ}$  Ans. (a)

Maximum deflection occurs at  $\beta \approx 64.6^\circ$  and  $\theta_{\max} \approx \mathbf{26.1^\circ}$  Ans. (b)

**9.127** Do the Mach waves upstream of an oblique-shock wave intersect with the shock? Assuming supersonic downstream flow, do the downstream Mach waves intersect the shock? Show that for small deflections the shock-wave angle  $\beta$  lies halfway between  $\mu_1$  and  $\mu_2 + \theta$  for any Mach number.

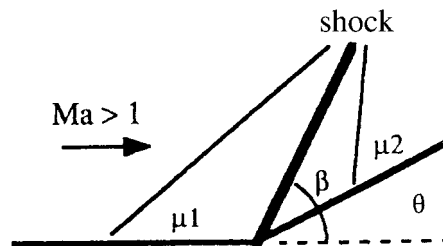


Fig. P9.127

**Solution:** Yes, Mach waves both upstream and downstream will intersect the shock:

$$\text{Linear theory: } \beta \approx \mu_1 + \frac{(k+1)\text{Ma}_1^2}{4\sqrt{(\text{Ma}_1^2-1)}}\theta \quad \text{and} \quad \beta - \theta \approx \mu_2 - \frac{(k+1)\text{Ma}_1^2}{4\sqrt{(\text{Ma}_1^2-1)}}\theta$$

Thus, to first order (small deflection), the shock wave angle  $\beta$  will lie **halfway between**  $\mu_1$  and  $(\mu_2 + \theta)$ , as sketched in the figure above.

**9.128** Air flows past a two-dimensional wedge-nosed body as in Fig. P9.128. Determine the wedge half-angle  $\delta$  for which the horizontal component of the total pressure force on the nose is 35 kN/m of depth into the paper.

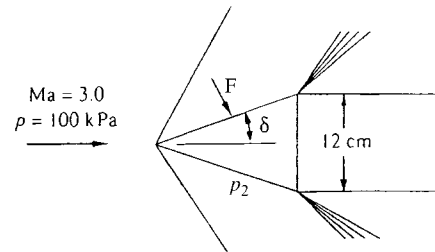


Fig. P9.128

**Solution:** Regardless of the wedge angle  $\delta$ , the horizontal force equals the pressure inside the shock times the projected vertical area of the nose:

$$F_{\text{horiz}} = p_2 A_{\text{vert proj}} = p_2 (0.12 \text{ m})(1.0 \text{ m}) = 35000 \text{ N}, \quad \text{or} \quad p_2 = 291700 \text{ Pa}$$

$$\text{Eq. (9.83a): } \frac{p_2}{p_1} = \frac{291700}{100000} = 2.917 = \frac{1}{2.4} [2.8 \text{Ma}_1^2 - 0.4], \quad \text{solve } \text{Ma}_1 \sin \beta = 1.63$$

$$\text{or } \beta = \sin^{-1} \left( \frac{1.63}{3.0} \right) = 32.81^\circ \quad \text{Use Eq. (9.86) to compute } \delta_{\text{wedge}} \approx 15.5^\circ \quad \text{Ans.}$$

**9.129** Air flows at supersonic speed toward a compression ramp, as in Fig. P9.129. A scratch on the wall at  $a$  creates a wave of  $30^\circ$  angle, while the oblique shock has a  $50^\circ$  angle. What is (a) the ramp angle  $\theta$ ; and (b) the wave angle  $\phi$  caused by a scratch at  $b$ ?

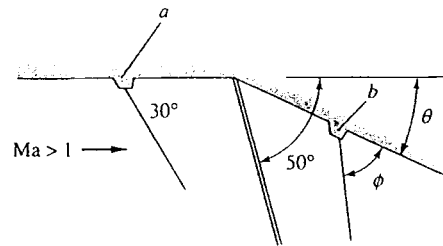


Fig. P9.129

**Solution:** The two “scratches” cause *Mach waves* which are directly related to Mach No.:

$$\mu_1 = 30^\circ, \quad \text{Ma}_1 = \csc 30^\circ = 2.0, \quad \beta = 50^\circ, \quad \text{Eq. 9.86 yields } \theta \approx 18.13^\circ \quad \text{Ans. (a)}$$

$$\text{Then } \text{Ma}_{2n} = 0.690 = \text{Ma}_2 \sin(50 - 18.13^\circ),$$

$$\text{Ma}_2 = 1.307, \quad \phi = \sin^{-1} \left( \frac{1}{1.307} \right) \approx 49.9^\circ \quad \text{Ans. (b)}$$

**9.130** Modify Prob. P9.129 as follows: If the wave angle  $\phi$  is  $42^\circ$ , determine (a) the shock wave angle (it is *not*  $50^\circ$ ) and (b) the deflection angle  $\theta$ .

**Solution:** Referring to Fig. P9.129, we already know that  $Ma_1 = 2.0$  because the Mach wave angle at point  $a$  is  $30^\circ$ . Now we know the Mach wave angle inside the shock:

$$\sin(\phi) = \sin(42^\circ) = \frac{1}{Ma_2} \quad \text{or:} \quad Ma_2 = 1.494$$

With  $Ma_1 = 2.0$  and  $Ma_2 = 1.494$ , we can determine  $\beta$  and  $\theta$  from Eqs. (9.83f) and (9.86):

$$Ma_2^2 \sin^2(\beta - \theta) = \frac{(k-1)Ma_1^2 \sin^2 \beta + 2}{2kMa_1^2 \sin^2 \beta - k + 1}; \quad \tan \theta = \frac{2 \cot \beta (Ma_1^2 \sin^2 \beta - 1)}{Ma_1^2 (k + \cos 2\beta) + 2}$$

This is an excellent job for EES, with the results  $\beta = 43.78^\circ$  Ans. (a) and  $\theta = 13.80^\circ$  Ans. (b)

**9.131** The following formula has been suggested as an alternate to Eq. (9.86) to relate upstream Mach number to the oblique shock wave angle  $\beta$  and turning angle  $\theta$ :

$$\sin^2 \beta = \frac{1}{Ma_1^2} + \frac{(k+1) \sin \beta \sin \theta}{2 \cos(\beta - \theta)}$$

Can you prove or disprove this relation? If not, try a few numerical values and compare with the results from Eq. (9.86).

**Solution:** The formula is quite correct and serves as an interesting alternative to Eq. (9.86). Notice that one can immediately solve for  $Ma_1$  if  $\beta$  and  $\theta$  are known, which would have been a great help in Prob. 9.124. For details of the proof, see page 371 of R. M. Olson, *Essentials of Engineering Fluid Mechanics*, 4<sup>th</sup> ed., Harper and Row, New York, 1980.

**9.132** Air flows at  $Ma = 3$  and  $p = 10$  psia toward a wedge of  $16^\circ$  angle at zero incidence, as in Fig. P9.132. (a) If the pointed edge is forward, what is the pressure at point A? If the blunt edge is forward, what is the pressure at point B?

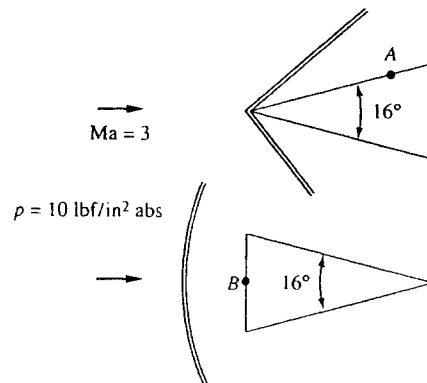


Fig. P9.132

**Solution:** For  $Ma = 3$ ,  $\theta = 8^\circ$ , Eq. 9.86:

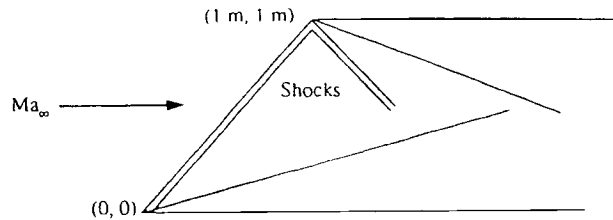
$$\beta = 25.61^\circ,$$

$$p_A/p_1 = \frac{2.8(3 \sin 25.61^\circ)^2 - 0.4}{2.4} = 1.80,$$

$$\therefore p_A \approx 18.0 \text{ psia} \quad \text{Ans. (a)}$$

(b) A normal shock forms, and  $p_B = p_{o2}$  inside the shock. Given  $p_{o1} = p_1/0.0272 = 367$  psia, Table B.2,  $Ma = 3$ :  $p_{o2}/p_{o1} = 0.3283$ , hence  $p_{o2} = 0.3283(367) = \mathbf{121}$  psia. *Ans. (b)*

**9.133** Air flows supersonically toward the double-wedge system in the figure. The  $(x,y)$  coordinates of the tips are given. Both wedges have  $15^\circ$  deflection angles. The shock wave of the forward wedge strikes the tip of the aft wedge. What is the freestream Mach number?

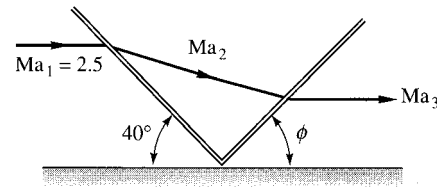


**Fig. P9.133**

**Solution:** However tricky the shock reflection might be at the upper (aft) wedge, the problem is solved by knowing the shock angle at the lower (forward) wedge:

$$\beta = \tan^{-1}(1.0) = 45^\circ, \quad \theta = 15^\circ, \quad \text{Eq. (9.86) yields } \mathbf{Ma_\infty = 2.01} \quad \text{Ans.}$$

**9.134** When an oblique shock strikes a solid wall, it reflects as a shock of sufficient strength to cause the exit flow  $Ma_3$  to be parallel to the wall, as in Fig. P9.134. For airflow with  $Ma_1 = 2.5$  and  $p_1 = 100$  kPa, compute  $Ma_3$ ,  $p_3$ , and the angle  $\phi$ .



**Fig. P9.134**

**Solution:** With  $\beta_1 = 40^\circ$ , we can compute the first shock deflection, which then must turn back the same amount through the second shock:

$$Ma_{1n} = 2.5 \sin 40^\circ = 1.607; \quad \text{Eq. (9.86): } \theta_1 = 17.68^\circ, \quad Ma_{2n} = 0.666, \quad Ma_2 = 1.754,$$

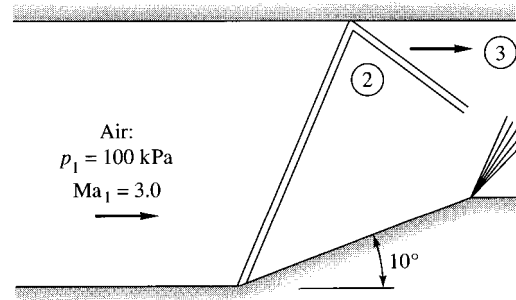
$$\text{Also } \theta_2 = 17.68^\circ, \quad \text{solve } \beta_2 = 60.45^\circ, \quad Ma_{2n} = 1.526, \quad Ma_{3n} = 0.692 = Ma_2 \sin(\beta_2 - \theta_2),$$

$$\text{Finally } \mathbf{Ma_3 \approx 1.02} \quad \text{Ans. (a)} \quad p_2/p_1 = 2.85, \quad p_2 = 285 \text{ kPa}, \quad p_3/p_2 = 2.55.$$

$$\text{Keep going: } p_3 = 2.55(285) \approx \mathbf{727 \text{ kPa}} \quad \text{Ans. (b)}$$

$$\text{Finally, } \phi = \beta_2 - \theta_2 = 60.56 - 17.68 \approx \mathbf{42.8^\circ} \quad \text{Ans. (c)}$$

**9.135** A bend in the bottom of a supersonic duct flow induces a shock wave which reflects from the upper wall, as in Fig. P9.135. Compute the Mach number and pressure in region 3.



**Fig. P9.135**

**Solution:** Given  $\theta = 10^\circ$ , find state 2:

$$Ma_1 = 3.0, \quad \theta_1 = 10^\circ,$$

$$\text{Eq. 9.86 predicts } \beta_1 \approx 27.38^\circ,$$

$$Ma_{1n} = 1.380, \quad Ma_{2n} = 0.748,$$

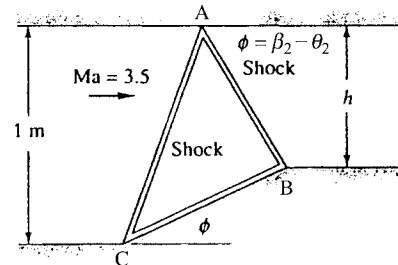
$$\therefore Ma_2 = 2.505, \quad \theta_2 = \theta_1 = 10^\circ, \quad \beta_2 = 31.80^\circ, \quad Ma_{2n} = 1.32, \quad Ma_{3n} = 0.776,$$

$$\therefore Ma_3 = \mathbf{2.09} \quad \text{Ans.}$$

$$\text{Meanwhile, } p_2/p_1 = 2.054, \quad \text{or } p_2 = 205.4 \text{ kPa,}$$

$$\text{and } p_3/p_2 = 1.866, \quad p_3 = 1.866(205.4) \approx \mathbf{383 \text{ kPa}} \quad \text{Ans.}$$

**9.136** Figure P9.136 is a special application of Prob. 9.135. With careful design, one can orient the bend on the lower wall so that the reflected wave is exactly canceled by the return bend, as shown. This is a method of reducing the Mach number in a channel (a supersonic diffuser). If the bend angle is  $\phi = 10^\circ$ , find (a) the downstream width  $h$  and (b) the downstream Mach number. Assume a weak shock wave.



**Fig. P9.136**

**Solution:** The important thing is to find the angle  $\phi$  between the *second* shock and the upper wall, as shown in the figure. With initial deflection  $= 10^\circ$ , proceed forward to “3”:

$$Ma_1 = 3.5, \quad \theta_1 = 10^\circ, \quad \text{compute } \beta_1 = 24.384^\circ, \quad Ma_2 = 2.904, \quad \theta_2 = \theta_1 = 10^\circ, \quad \beta_2 = 28.096^\circ,$$

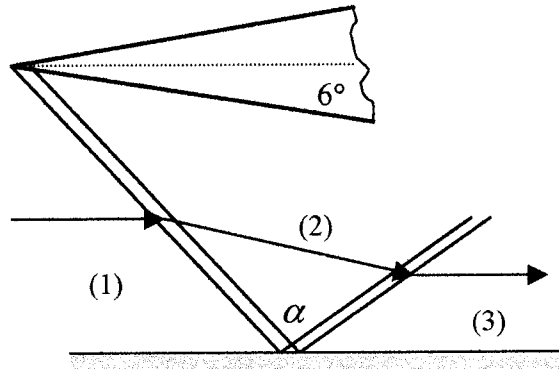
$$\phi_{\text{upper wall}} = \beta_2 - \theta_2 = 28.096 - 10 = 18.096^\circ, \quad Ma_3 = 2.427 \quad \text{Ans. (b)}$$

Length  $CB$  in the figure  $= (1 \text{ m})/\sin(24.384^\circ) = 2.422 \text{ m}$ , angle  $ACB = 14.384^\circ$ , angle  $CBA = \beta_2 = 28.096^\circ$ , by the law of sines,  $AB/\sin(14.384^\circ) = 2.422/\sin(28.096^\circ)$  or the length  $AB = 1.278 \text{ m}$ . Finally, duct width  $h = 1.278\sin(18.096^\circ) \approx \mathbf{0.40 \text{ m}}$ . *Ans. (a)*

The horizontal distance from one lower corner to the next is 3.42 m. The length of  $CB$  is 3.47 m. Thus the shocks are not drawn to scale in the figure.



**9.137** A  $6^\circ$  half-angle wedge creates the reflected shock system in Fig. P9.137. If  $Ma_3 = 2.5$ , find (a)  $Ma_1$ ; and (b) the angle  $\alpha$ .



**Fig. P9.137**

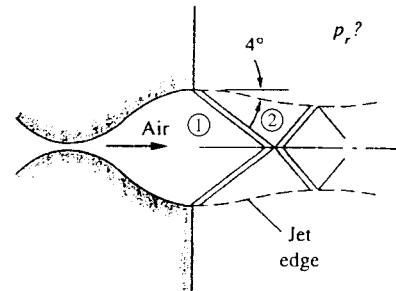
**Solution:** (a) We have to go backward from region 3 to regions 2 and 1, using Eq. (9.86). In both cases the turning angle is  $\theta = 6^\circ$ . EES is of course excellent for this task, otherwise the iteration will be laborious. The results are:

$$Ma_2 = 2.775, \quad \beta_2 = 25.66^\circ, \quad Ma_1 = 3.084, \quad \beta_1 = 23.36^\circ \quad \text{Ans. (a)}$$

Since the wall is horizontal, it is clear from the geometry of Fig. P9.137 that

$$\alpha = 180^\circ - 25.66^\circ - 23.36^\circ = \mathbf{130.98^\circ} \quad \text{Ans. (b)}$$

**9.138** The supersonic nozzle of Fig. P9.138 is *overexpanded* (case G of Fig. 9.12) with  $A_e/A_t = 3.0$  and a stagnation pressure of 350 kPa. If the jet edge makes a  $4^\circ$  angle with the nozzle centerline, what is the back pressure  $p_r$  in kPa?



**Fig. P9.138**

**Solution:** The nozzle is clearly choked because there are shock waves downstream. Thus

$$\frac{A_e}{A^*} = 3.0, \quad \text{read } Ma_e = Ma_1 = 2.64, \quad p_e = 350/[1 + 0.2(2.64)^2]^{3.5} = 16.5 \text{ kPa}$$

$$\theta = 4^\circ, \quad \text{Eq. 9.86 gives } \beta_2 = 25.3^\circ, \quad Ma_{1n} = 2.64 \sin 25.3^\circ = 1.125, \quad p_2/p_1 = 1.311$$

$$\text{Thus } p_2 = p_{\text{receiver}} = 1.311(16.5) \approx \mathbf{21.7 \text{ kPa}} \quad \text{Ans.}$$

**9.139** Airflow at  $Ma = 2.2$  takes a compression turn of  $12^\circ$  and then another turn of angle  $\theta$  in Fig. P9.139. What is the maximum value of  $\theta$  for the second shock to be *attached*? Will the two shocks intersect for any  $\theta$  less than  $\theta_{\max}$ ?

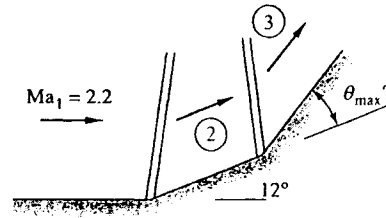


Fig. P9.139

**Solution:** First get the conditions in section (2) and then iterate for  $\theta_{\max}$ :

$$Ma_1 = 2.2, \theta = 12^\circ, \text{ Eq. 9.86: } \beta_1 = 37.87^\circ, Ma_{1n} = 1.351, Ma_{2n} = 0.762 = Ma_2 \sin(\beta - \theta)$$

or:  $Ma_2 \approx \mathbf{1.745}$ . For this Mach number, estimate  $\theta_{\max} \approx 18^\circ$  from Fig. 9.23

Iterate, by trial and error, find  $\theta_{\max} \approx \mathbf{18.02^\circ}$  Ans.

NOTE: The two shocks  $\beta_1$  and  $\beta_2$  **always** intersect for any  $\theta_2 < \theta_{\max}$ . Ans.

**9.140** The solution to Prob. 9.122 is  $Ma_2 = 2.750$  and  $p_2 = 145.5$  kPa. Compare these results with an isentropic compression turn of  $5^\circ$ , using Prandtl-Meyer theory.

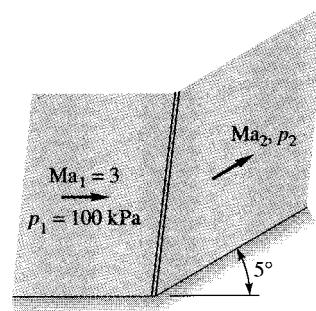


Fig. P9.122

**Solution:** Find  $\omega$  for  $Ma = 3$  and subtract  $5^\circ$ :

$$Ma_1 = 3.0, \text{ Table B.5: } \omega_1 = 49.76^\circ,$$

$$\omega_2 = 49.76 - 5 = 44.76^\circ, \text{ read } Ma_2 \approx \mathbf{2.753}$$

$$\text{Then } p_2 = p_1 \left( \frac{p_2/p_0}{p_1/p_0} \right) = 100 \left[ \frac{1 + 0.2(2.753)^2}{1 + 0.2(3.0)^2} \right]^{-3.5} \approx \mathbf{145.4 \text{ kPa}} \text{ Ans.}$$

This is almost identical to the shock wave result, because a  $5^\circ$  turn is nearly isentropic.

**9.141** Supersonic airflow takes a  $5^\circ$  expansion turn, as in Fig. P9.141. Compute the downstream Mach number and pressure and compare with small-disturbance theory.

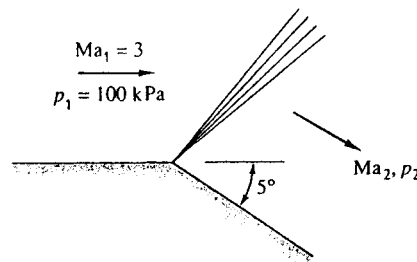


Fig. P9.141

**Solution:** Find  $\omega$  for  $Ma = 3$  and *add*  $5^\circ$ :

$$Ma_1 = 3.0, \text{ Table B.5: } \omega_1 = 49.76^\circ,$$

$$\omega_2 = 49.76 + 5 = 54.76^\circ,$$

$$\text{Read } Ma_2 \approx \mathbf{3.274} \text{ Ans.}$$

$$\text{Then } p_2 = p_1 \left( \frac{p_2/p_o}{p_1/p_o} \right) = 100 \left[ \frac{1 + 0.2(3.274)^2}{1 + 0.2(3.0)^2} \right]^{-3.5} \approx \mathbf{66.7 \text{ kPa}} \quad \text{Ans.}$$

The linear theory is not especially accurate because even a 5° turn is slightly nonlinear:

$$\text{Eq. 9.89: } \frac{\Delta p}{p} \approx \frac{k \text{Ma}^2}{\sqrt{\text{Ma}^2 - 1}} \tan \theta_2 = \frac{1.4(3)^2}{\sqrt{3^2 - 1}} \tan(-5^\circ) = -0.390,$$

$$p = 100(1 - 0.390) \approx \mathbf{61 \text{ kPa}} \quad \text{Ans. (9\% low)}$$

**9.142** A supersonic airflow at  $\text{Ma}_1 = 3.2$  and  $p_1 = 50 \text{ kPa}$  undergoes a compression shock followed by an isentropic expansion turn. The flow deflection is  $30^\circ$  for each turn. Compute  $\text{Ma}_2$  and  $p_2$  if (a) the shock is followed by the expansion and (b) the expansion is followed by the shock.

**Solution:** The solution is given in the form of the two sketches below. A shock wave with a  $30^\circ$  turn is a hugely non-isentropic flow, so the final conditions are nowhere near the original and they do not agree with each other either.

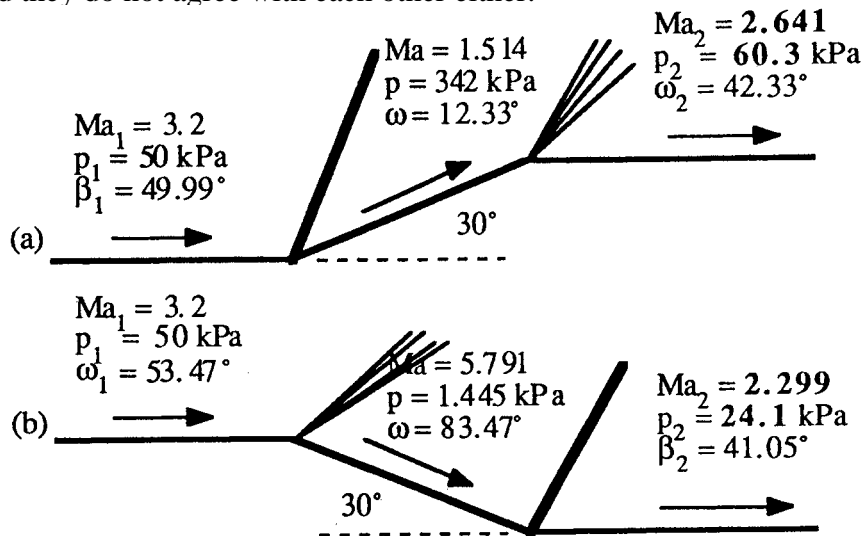


Fig. P9.142

**9.143** Airflow at  $\text{Ma}_1 = 3.2$  passes through a  $25^\circ$  oblique-shock deflection. What isentropic expansion turn is required to bring the flow back to (a)  $\text{Ma}_1$  and (b)  $p_1$ ?

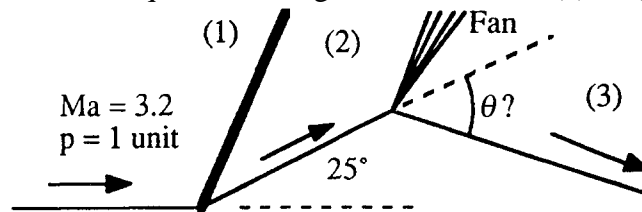


Fig. P9.143

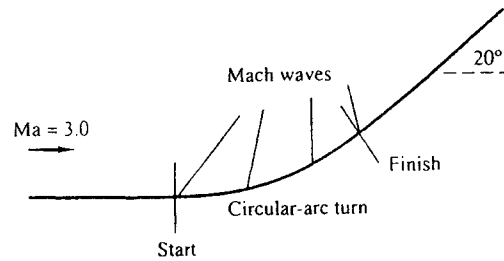
**Solution:** First work out state (2):

$$\text{Ma}_1 = 3.2, \beta_1 = 42.56^\circ, \text{Ma}_2 = 1.83, p_2 = 5.30 \text{ units}, \omega_2 = 21.59^\circ$$

(a)  $\text{Ma}_3 = 3.2$  means  $\omega_2 = 53.47^\circ$ , or  $\theta = 53.47 - 21.59 \approx \mathbf{31.9^\circ}$  Ans. (a)

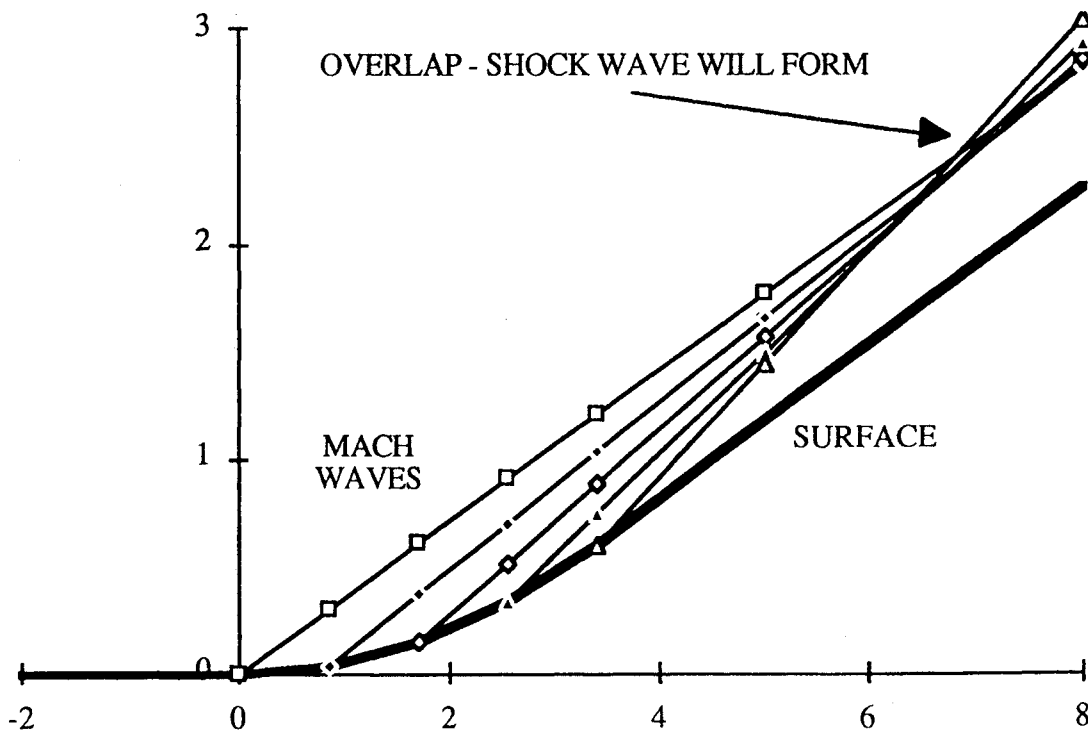
(b)  $p_3 = 1$  unit means  $\text{Ma}_3 = 2.906$ ,  $\omega_3 = 47.90^\circ$ ,  $\theta = 47.90 - 21.59 = \mathbf{26.3^\circ}$  Ans. (b)

**9.144** Consider a smooth isentropic compression turn of  $20^\circ$ , as in Fig. P9.144. The Mach waves thus generated will form a converging fan. Sketch this fan as accurately as possible, using five equally-spaced waves, and demonstrate how the fan indicates the probable formation of an oblique shock wave.



**Fig. P9.144**

**Solution:** The desired sketch is shown below. The final state after the  $20^\circ$  isentropic turn is  $\text{Ma} = 2.125$ . The Mach waves cross each other, so an oblique shock will form. In the figure below, the y-axis is exaggerated for clarity of the Mach waves.



**9.145** Air at  $Ma_1 = 2.0$  and  $p_1 = 100$  kPa undergoes an isentropic expansion to a downstream pressure of 50 kPa. What is the desired turn angle in degrees?

**Solution:** This is a real ‘quickie’ compared to what we have been doing for the past few problems. Isentropic expansion to a new pressure specifies the downstream Mach number:

$$p_o = p_1 \left[ 1 + 0.2 Ma_1^2 \right]^{3.5} = 100 [1 + 0.2(2)^2]^{3.5} = 782 \text{ kPa}$$

$$p_2/p_o = \frac{50}{782} = 0.0639, \quad \text{read } Ma_2 \approx 2.44, \quad \text{read } \omega_2 \approx 37.79^\circ,$$

$$\text{while } \omega_1 \approx 26.38^\circ, \quad \therefore \Delta\theta = 37.79 - 26.38 \approx \mathbf{11.4^\circ} \quad \text{Ans.}$$

**9.146** Air flows supersonically over a surface which changes direction twice, as in Fig. P9.146. Calculate (a)  $Ma_2$ ; and (b)  $p_3$ .

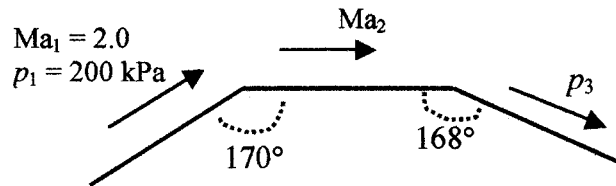


Fig. P9.146

**Solution:** (a) At the initial condition  $Ma_1 = 2.0$ , from Table B.5 read  $\omega_1 = 26.38^\circ$ . The first turn is  $10^\circ$ , so  $\omega_2 = 26.38 + 10 = 36.38^\circ$ . From Table B.5 read  $Ma_2 = 2.38$ . For more accuracy, use Eq. (9.99) to obtain  $\mathbf{Ma_2 = 2.385}$ . Ans. (a)

(b) The second turn is  $12^\circ$ , so  $\omega_3 = 36.38 + 12 = 48.38^\circ$ . From Table B.5 read  $Ma_3 = 2.93$ . For more accuracy, use Eq. (9.99) to obtain  $Ma_2 = 2.9296$ . (Not worth the extra effort.) To find pressures, we need the stagnation pressure, which is constant:

$$p_o = p_1 \left( 1 + 0.2 Ma_1^2 \right)^{3.5} = (200 \text{ kPa}) [1 + 0.2(2.0)^2]^{3.5} = 1565 \text{ kPa}$$

$$\text{Then } p_3 = p_o / \left( 1 + 0.2 Ma_3^2 \right)^{3.5} = (1565) / [1 + 0.2(2.9296)^2]^{3.5} = \mathbf{47.4 \text{ kPa}} \quad \text{Ans. (b)}$$

**9.147** A converging-diverging nozzle with a 4:1 exit-area ratio and  $p_0 = 500$  kPa operates in an underexpanded condition (case 1 of Fig. 9.12) as in Fig. P9.147. The receiver pressure is  $p_a = 10$  kPa, which is less than the exit pressure, so that expansion waves

form outside the exit. For the given conditions, what will the Mach number  $Ma_2$  and the angle  $\phi$  of the edge of the jet be? Assume  $k = 1.4$  as usual.

**Solution:** Get the Mach number in the exit and then execute a Prandtl-Meyer expansion:

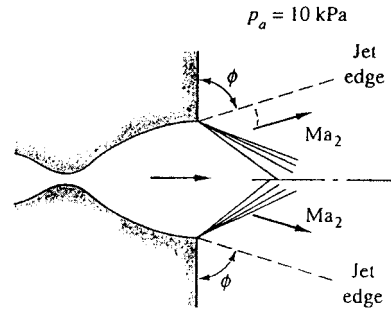


Fig. P9.147

$$\frac{A_e}{A^*} = 4.0, \quad \text{read } Ma_e \approx 2.94, \quad \text{Table B.5: } \omega_1 = 48.59^\circ, \quad p_{o1} = p_{o2} = 500 \text{ kPa}$$

$$p_o/p_2 = \frac{500}{10} = 50, \quad \text{read } Ma_2 \approx \mathbf{3.21} \quad \text{Ans. (a)} \quad \text{Read } \omega_2 = 53.61^\circ,$$

$$\therefore \Delta\theta = 53.61 - 48.59 = 5.02^\circ, \quad \text{or } \phi_{\text{see figure above}} = 90 - \Delta\theta \approx \mathbf{85.0^\circ} \quad \text{Ans. (b)}$$

**9.148** Air flows supersonically over a circular-arc surface as in Fig. P9.148. Estimate (a) the Mach number  $Ma_2$  and (b) the pressure  $p_2$  as the flow leaves the circular surface.

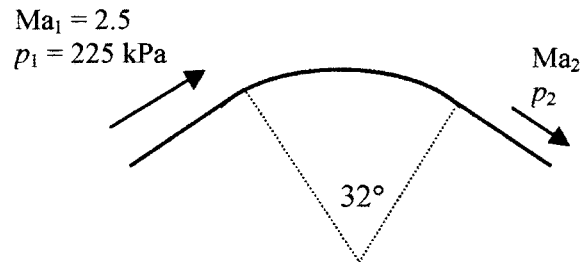


Fig. P9.148

**Solution:** (a) At the initial condition  $Ma_1 = 2.5$ , from Table B.5 read  $\omega_1 = 39.12^\circ$ . (a) Circular arc or not, the turn angle is  $32^\circ$ , so  $\omega_2 = 39.12 + 32 = 71.12^\circ$ . From Table B.5 read  $Ma_2 = 4.44$ . For more accuracy, use Eq. (9.99) to obtain  $\mathbf{Ma_2 = 4.437}$ . Ans. (a)

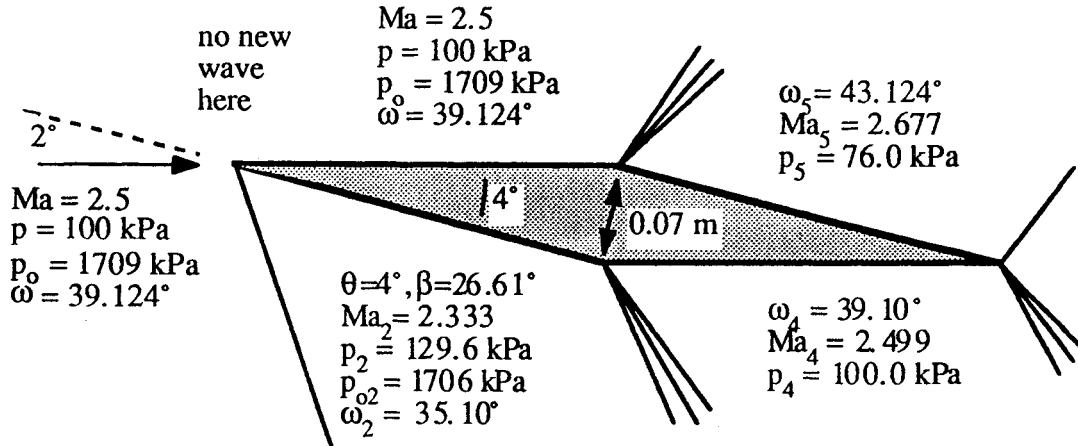
(b) To find  $p_2$ , first find the stagnation pressure:

$$p_o = p_1 (1 + 0.2 Ma_1^2)^{3.5} = (150 \text{ kPa}) [1 + 0.2(2.5)^2]^{3.5} = 2563 \text{ kPa}$$

$$\text{Then } p_2 = p_o / (1 + 0.2 Ma_2^2)^{3.5} = (2563) / [1 + 0.2(4.437)^2]^{3.5} = \mathbf{9.6 \text{ kPa}} \quad \text{Ans. (b)}$$

**9.149** Repeat Example 9.21 for an angle of attack of  $2^\circ$ . Is the lift coefficient *linear* with  $\alpha$  in this range of  $0^\circ < \alpha < 8^\circ$ ? Why does the drag coefficient not have the simple parabolic form  $C_D \approx K\alpha^2$  in this range?

**Solution:** The various calculations for surface pressure are listed in the sketch below.



The forces are calculated as in Example 9.21:

$$F = \frac{1}{2}(29.6 + 24.0)(2 \text{ m}^2) \approx 53.6 \text{ kN}, \quad P = \frac{1}{2}(24.0 + 29.6)(0.07)(1) \approx 1.87 \text{ kN}$$

$$L = F \cos 2^\circ - P \sin 2^\circ = 53.5 \text{ kN}, \quad C_L = 53.5 / \frac{k}{2} (100)(2.5)^2 (2) = \frac{53.5}{875} = \mathbf{0.0611} \quad \text{Ans. (a)}$$

$$D = F \sin 2^\circ + P \cos 2^\circ \approx 3.74 \text{ kN}, \quad C_D = 3.74/875 \approx \mathbf{0.00427} \quad \text{Ans. (b)}$$

The lift is quite linear,  $C_L \approx \mathbf{1.75} \alpha_{\text{radians}}$  (compared with  $1.75\alpha$  also in linearized theory), but the drag is not purely parabolic through the origin,  $C_D \approx \mathbf{0.00209} + \mathbf{1.79} \alpha^2$  (compared with  $0.00212 + 1.75\alpha^2$  according to Ackeret theory, Eq. 9.107). The reason is that there is **thickness-drag** for this diamond-shaped airfoil. *Ans.*

**9.150** A flat plate airfoil with chord  $C = 1.2$  m is to have a lift of 30 kN/m when flying at 5000-m standard altitude with  $U_\infty = 641$  m/s. Using Ackeret theory, estimate (a) the angle of attack; and (b) the drag force in N/m.

**Solution:** At 5000 m,  $\rho = 0.7361 \text{ kg/m}^3$ ,  $T = 256 \text{ K}$ , and  $p = 54008 \text{ Pa}$ . Compute  $Ma$ :

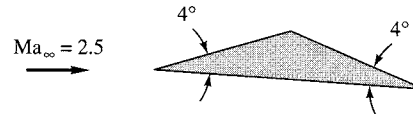
$$Ma = \frac{641}{\sqrt{1.4(287)(256)}} = 2.00, \quad C_L = \frac{30000}{(1/2)(0.7361)(641)^2(1.2)(1)} = 0.1653 \approx \frac{4\alpha}{\sqrt{(2)^2 - 1}}$$

$$\text{Solve for } \alpha = 0.0716 \text{ rad} \approx \mathbf{4.10^\circ} \quad \text{Ans.}$$

With angle of attack known, Ackeret theory simply predicts that

$$D = L \tan \alpha = 30000 \tan(4.10^\circ) \approx \mathbf{2150 \text{ N/m}} \quad \text{Ans. (b)}$$

**9.151** Air flows at  $Ma = 2.5$  past a half-wedge airfoil whose angles are  $4^\circ$ , as in Fig. P9.151. Compute the lift and drag coefficients at  $\alpha$  equal to (a)  $0^\circ$ ; and (b)  $6^\circ$ .



**Fig. P9.151**

**Solution:** Let's use Ackeret theory here:

$$(a) \alpha = 0^\circ: \quad C_L \approx \mathbf{0}; \quad C_D \approx \frac{4}{\sqrt{(2.5)^2 - 1}} \left[ 0^2 + \frac{1}{2} (\tan^2 4^\circ + 0) \right] \approx \mathbf{0.00427} \quad \text{Ans. (a)}$$

[A complete shock-expansion calculation gives  $C_L \approx -0.0065$ ,  $C_D \approx 0.00428$ .]

$$(b) \alpha = 6^\circ = 0.105 \text{ rad}: \quad C_L = \frac{4(0.105)}{\sqrt{5.25}} \approx \mathbf{0.183},$$

$$C_D = \frac{4}{\sqrt{5.25}} [(0.105)^2 + (1/2)(\tan^2 4^\circ + 0)] \approx \mathbf{0.0234} \quad \text{Ans. (b)}$$

[A complete shock-expansion calculation gives  $C_L \approx 0.179$ ,  $C_D \approx 0.0219$ .]

**9.152** A supersonic airfoil has a parabolic symmetric shape for upper and lower surfaces

$$y_{u,l} = \pm 2t \left( \frac{x}{C} - \frac{x^2}{C^2} \right)$$

such that the maximum thickness is  $t$  at  $x = \frac{1}{2}C$ . Compute the drag coefficient at zero incidence by Ackeret theory, and compare with a symmetric double wedge of the same thickness.

**Solution:** Evaluate the mean-square surface slope and then use Eq. (9.107):

$$y'_{\text{upper}} = \frac{2t}{C} \left( 1 - \frac{2x}{C} \right),$$

$$\overline{y'^2} = \frac{1}{C} \int_0^C \left[ \frac{2t}{C} \left( 1 - \frac{2x}{C} \right) \right]^2 dx = \frac{4}{3} \frac{t^2}{C^2} \quad (\text{for both upper and lower surfaces})$$

$$\text{At } \alpha = 0, \quad C_D = \frac{4}{\sqrt{Ma_\infty^2 - 1}} \left[ 0^2 + \frac{1}{2} \left\{ 2 \left( \frac{4}{3} \frac{t^2}{C^2} \right) \right\} \right], \quad \text{or:} \quad C_D = \frac{4}{\sqrt{Ma_\infty^2 - 1}} \left[ \frac{4}{3} \frac{t^2}{C^2} \right] \quad \text{Ans.}$$



For a *double-wedge* foil of the same thickness,  $y' = t/C$  on both surfaces:

$$\overline{y'^2} |_{\text{avg}} = t^2/C^2, \quad \text{Eq. 9.107 yields } C_{D,\text{double-wedge}} \approx \frac{4}{\sqrt{\text{Ma}_\infty^2 - 1}} \left[ \frac{t^2}{C^2} \right] \quad \text{(25\% less) } \textit{Ans.}$$

**9.153** A supersonic transport has a mass of 65 Mg and cruises at 11-km standard altitude at a Mach number of 2.25. If the angle of attack is  $2^\circ$  and its wings can be approximated by flat plates, estimate (a) the required wing area; and (b) the thrust.

**Solution:** At 11 km (Table B.6), take  $p_\infty = 22612$  Pa. (a) Use linearized theory:

$$C_L = \frac{4\alpha}{\sqrt{M_\infty^2 - 1}} = \frac{4(2\pi/180)}{\sqrt{2.25^2 - 1}} = 0.0693 = \frac{W}{\frac{k}{2} p M a^2 A} = \frac{65000(9.81)}{0.7(22612)(2.25)^2 A},$$

$$\mathbf{A = 115 \text{ m}^2} \quad \textit{Ans. (a)}$$

(b) According to linearized (Ackeret) theory, if there is no thickness drag, then

$$\text{Drag} = \text{Lift} \times \alpha, \quad \text{or} \quad \text{Drag} = \text{Thrust} = 65000(9.81)(2\pi/180) = \mathbf{22,300 \text{ N}} \quad \textit{Ans. (b)}$$

**9.154** A symmetric supersonic airfoil has its upper and lower surfaces defined by a sine waveshape:

$$y = \frac{t}{2} \sin \frac{\pi x}{C}$$

where  $t$  is the maximum thickness, which occurs at  $x = C/2$ . Use Ackeret theory to derive an expression for the drag coefficient at zero angle of attack. Compare your result with Ackeret theory for a symmetric double-wedge airfoil of the same thickness.

**Solution:** Evaluate the mean-square surface slope and then use Eq. (9.107):

$$y' = \frac{\pi t}{2C} \cos\left(\frac{\pi x}{C}\right), \quad y'^2 = \frac{1}{C} \int_0^C \left(\frac{\pi t}{2C}\right)^2 \cos^2\left(\frac{\pi x}{C}\right) dx = \frac{\pi^2}{8} \left(\frac{t}{C}\right)^2$$

$$\text{At } \alpha = 0, \quad C_D = \frac{4}{\sqrt{(\text{Ma}_\infty^2 - 1)}} \left[ 0^2 + \frac{1}{2} \left\{ 2 \left( \frac{\pi^2 t^2}{8 C^2} \right) \right\} \right],$$

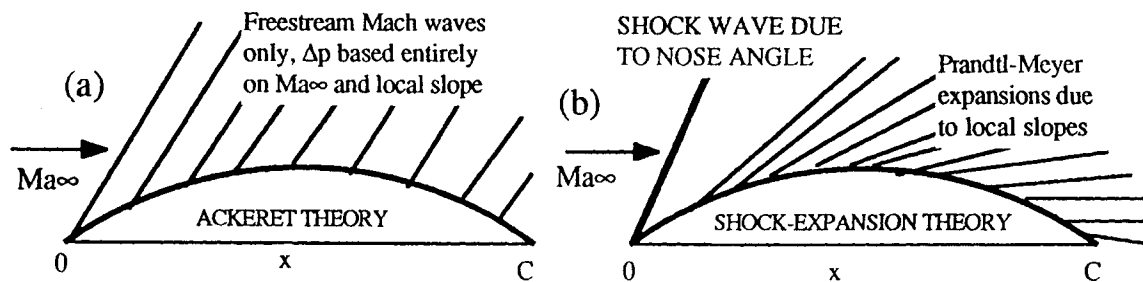
$$\text{or: } \mathbf{C_D = \frac{4}{\sqrt{\text{Ma}_\infty^2 - 1}} \left( \frac{\pi^2}{8} \right) \left( \frac{t}{C} \right)^2} \quad \textit{Ans.}$$

Meanwhile, for a double-wedge of the same thickness  $t$ , from Prob. 9.152,

$$C_{D,\text{double-wedge}} = \frac{4}{\sqrt{\text{Ma}_\infty^2 - 1}} \left( \frac{t}{C} \right)^2 \quad (19\% \text{ less}) \quad \text{Ans.}$$

**9.155** For the sine-wave airfoil shape of Prob. 9.154, with  $\text{Ma}_\infty = 2.5$ ,  $k = 1.4$ ,  $t/C = 0.1$ , and  $\alpha = 0^\circ$ , plot (without computing the overall forces) the pressure distribution  $p(x)/p_\infty$  along the upper surface for (a) Ackeret theory and (b) an oblique shock plus a continuous Prandtl-Meyer expansion.

**Solution:** A sketch of the physical differences between the two theories is shown below:



For Ackeret theory, simply evaluate the local slopes and apply Eq. (9.89):

$$y = \frac{t}{2} \sin\left(\frac{\pi x}{C}\right), \quad \frac{dy}{dx} = \frac{\pi t}{2C} \cos\left(\frac{\pi x}{C}\right), \quad \frac{p}{p_\infty} \approx 1 + \frac{k \text{Ma}_\infty^2}{\sqrt{\text{Ma}_\infty^2 - 1}} \frac{dy}{dx}, \quad \text{where } \frac{t}{C} = \mathbf{0.1}$$

For shock-expansion theory, evaluate the nose slope and solve the leading edge shock:

$$\left. \frac{dy}{dx} \right|_{\text{nose}} = \frac{\pi t}{2C} = \frac{\pi}{2} (0.1) = \tan \theta_0, \quad \theta_0 \approx 8.93^\circ, \quad \text{Ma}_1 = 2.5, \quad \text{solve } \beta \approx 30.85^\circ,$$

$$\text{Ma}_2 = 2.130, \quad \omega_2 = 29.905^\circ, \quad p_2/p_\infty = 1.750 \quad \text{just inside the shock.}$$

Continue  $\text{Ma}(x)$  based on  $\omega(x) = \omega_2 + \tan^{-1}(dy/dx)$  plus  $p_{o2} = \text{constant}$  (isentropic)

The results may be tabulated and plotted as shown below:

$x/C$ :    0.0    0.1    0.2    0.3    0.4    0.5    0.6    0.7    0.8    0.9    1.0

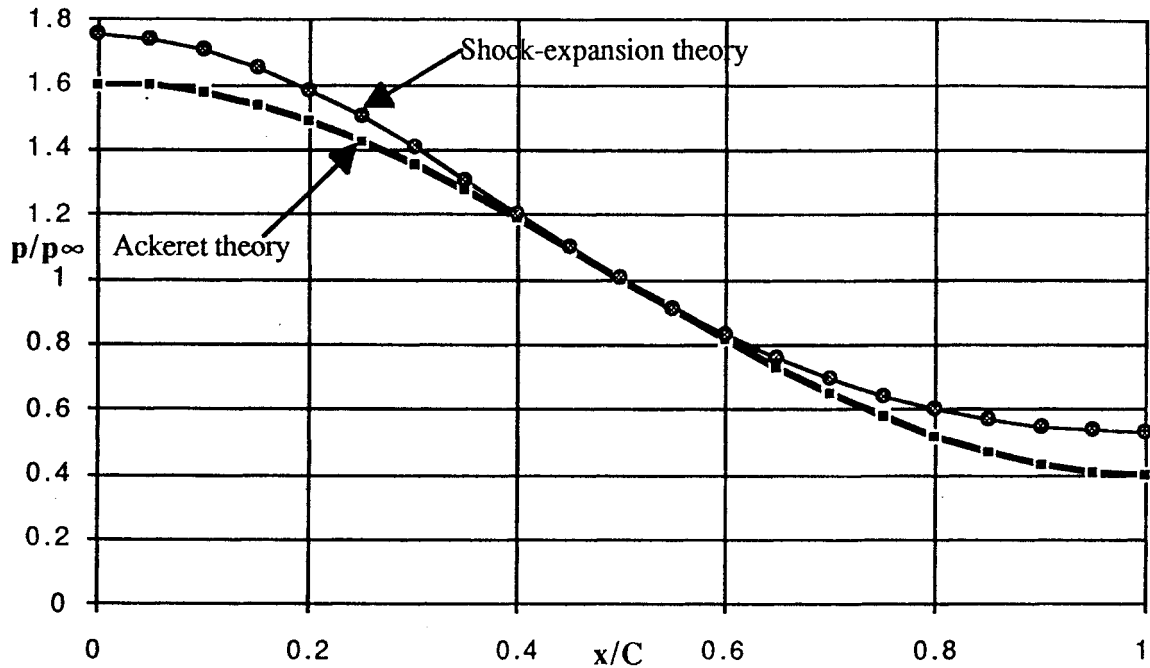
Ackeret theory,

$p/p_\infty$ :   1.60   1.57   1.49   1.35   1.19   1.00   0.81   0.65   0.51   0.43   0.40

Shock-expansion theory:

$p/p_\infty$ :   1.75   1.71   1.58   1.40   1.20   1.00   0.83   0.70   0.60   0.55   0.53

The agreement is pretty good, and the **integrated drag** is in even better agreement.



**9.156** A thin circular-arc airfoil is shown in Fig. P9.156. The leading edge is parallel to the free stream. Using linearized (small-turning-angle) supersonic-flow theory, derive a formula for the lift and drag coefficient for this orientation, and compare with Ackeret-theory results for an angle of attack  $\alpha = \tan^{-1}(h/L)$ .

**Solution:** For the  $(x,y)$  coordinate system shown, the formula for the plate surface is

$$y_{\text{foil}} = \sqrt{R^2 - x^2} - R + h,$$

where  $R = \frac{L^2 + h^2}{2h}$ , and  $\frac{dy}{dx} = -\frac{x}{\sqrt{R^2 - x^2}}$

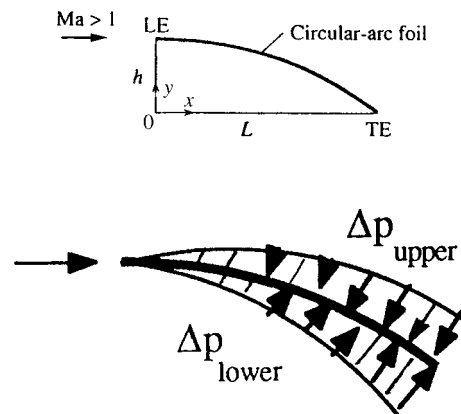


Fig. P9.156

If  $h \ll L$  (small disturbances),  $R \gg L$ ,  $h$ . Since the flow approaches parallel to the leading edge, the pressure distribution on the airfoil looks like the bottom figure on the previous page. We compute this pressure distribution from the linearized expression, Eq. (9.89):

$$\frac{\Delta p}{p_\infty} \approx B \frac{dy}{dx}, \quad \text{where } B = \frac{kMa_\infty^2}{\sqrt{Ma_\infty^2 - 1}}; \quad \text{Thus } \Delta p_{\text{lower}} - \Delta p_{\text{upper}} = \frac{2Bx}{\sqrt{R^2 - x^2}} p_\infty$$

$$\text{Lift} = \int_{\text{foil}} \Delta p_{\text{total}} dA_{\text{foil}} = 2Bp_\infty \int_0^L x(R^2 - x^2)^{-1/2} \cos\theta b \, dx,$$

$$\text{where } \cos\theta = \left[1 + (dy/dx)^2\right]^{-1/2}$$

Carry out this integration, assuming that  $h \ll L$ ,  $R \gg L$ , chord length  $C \approx L$ , to obtain

$$\text{Lift} \approx \frac{2kMa_\infty^2}{\sqrt{Ma_\infty^2 - 1}} p_\infty bh, \quad \text{or } C_L = \frac{\text{Lift}}{(k/2)Ma_\infty^2 p_\infty bL} \approx \frac{4}{\sqrt{Ma_\infty^2 - 1}} \frac{h}{L} \quad \text{Ans. (a)}$$

But  $h/L \approx \alpha_{\text{radians}}$ , therefore  $C_L \approx \left[4/\sqrt{Ma_\infty^2 - 1}\right] \alpha$ , which is exactly Ackeret theory.

$$\text{Similarly, } \text{Drag} = 2Bp_\infty \int_0^L x(R^2 - x^2)^{-1/2} \sin\theta b \, dx \approx \left[2kMa_\infty^2 (Ma_\infty^2 - 1)^{-1/2}\right] p_\infty bh \left(\frac{4h}{3L}\right)$$

$$\text{or: } C_D \approx \left[4/\sqrt{Ma_\infty^2 - 1}\right] (h/L)^2 \left(1 + \frac{1}{3}\right) \approx C_L \alpha^2 \left(1 + \frac{1}{3}\right) \quad \text{Ans. (b)}$$

This is exactly the same as Ackeret theory. The extra term “1/3” is the “thickness-drag” contribution (actually the **camber** slope contribution) from Eqs. (9.106, 107) of the text.

**9.157** Prove from Ackeret theory that for a given supersonic airfoil shape with sharp leading and trailing edges and a given thickness, the minimum-thickness drag occurs for a symmetric double-wedge shape.

**Solution:** This (final) problem is merely to alert the reader to such a theorem. The proof itself is very laborious and is not intended to be assigned to students.

The proof involves first showing that, for any foil surface shape between two points, a *straight line* gives the lowest drag. Then you show that, for any max thickness, the lowest straight-line drag shape is the symmetrical double-wedge airfoil of, e.g., Fig. E9.21 of the text. A complete proof is given in the text by F. Cheers (Ref. 3 of Chapter 9).

**FUNDAMENTALS OF ENGINEERING EXAM PROBLEMS: Answers**

In the following problems, assume one-dimensional flow of ideal air,  $R = 287 \text{ J}/(\text{kg}\cdot\text{K})$  and  $k = 1.4$ .

FE9.1 For steady isentropic flow, if the absolute temperature increases 50%, by what ratio does the static pressure increase?

- (a) 1.12 (b) 1.22 (c) 2.25 (d) 2.76 (e) **4.13**

FE9.2 For steady isentropic flow, if the density doubles, by what ratio does the static pressure increase?

- (a) 1.22 (b) 1.32 (c) 1.44 (d) **2.64** (e) 5.66

FE9.3 A large tank, at 500 K and 200 kPa, supplies isentropic air flow to a nozzle. At section 1, the pressure is only 120 kPa. What is the Mach number at this section?

- (a) 0.63 (b) 0.78 (c) **0.89** (d) 1.00 (e) 1.83

FE9.4 In Prob. FE9.3 what is the temperature at section 1?

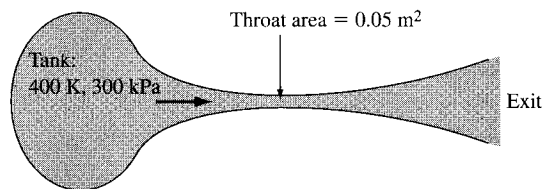
- (a) 300 K (b) 408 K (c) 417 K (d) **432 K** (e) 500 K

FE9.5 In Prob. FE9.3, if the area at section 1 is  $0.15 \text{ m}^2$ , what is the mass flow?

- (a) 38.1 kg/s (b) **53.6 kg/s** (c) 57.8 kg/s (d) 67.8 kg/s (e) 77.2 kg/s

FE9.6 For steady isentropic flow, what is the maximum possible mass flow through the duct in Fig. FE9.6? ( $T_o = 400 \text{ K}$ ,  $p_o = 300 \text{ kPa}$ )

- (a) 9.5 kg/s (b) 15.1 kg/s (c) 26.2 kg/s (d) **30.3 kg/s** (e) 52.4 kg/s



**Fig. FE9.6**

FE9.7 If the exit Mach number in Fig. FE9.6 is 2.2, what is the exit area?

- (a)  **$0.10 \text{ m}^2$**  (b)  $0.12 \text{ m}^2$  (c)  $0.15 \text{ m}^2$  (d)  $0.18 \text{ m}^2$  (e)  $0.22 \text{ m}^2$

FE9.8 If there are no shock waves and the pressure at one duct section in Fig. FE9.6 is 55.5 kPa, what is the velocity at that section?

- (a) 166 m/s (b) 232 m/s (c) **554 m/s** (d) 706 m/s (e) 774 m/s

FE9.9 If, in Fig. FE9.6, there is a normal shock wave at a section where the area is  $0.07 \text{ m}^2$ , what is the air density just upstream of that shock?

- (a)  $0.48 \text{ kg}/\text{m}^3$  (b)  **$0.78 \text{ kg}/\text{m}^3$**  (c)  $1.35 \text{ kg}/\text{m}^3$  (d)  $1.61 \text{ kg}/\text{m}^3$  (e)  $2.61 \text{ kg}/\text{m}^3$

FE9.10 In Prob. FE9.9, what is the Mach number just downstream of the shock wave?

- (a) 0.42 (b) 0.55 (c) **0.63** (d) 1.00 (e) 1.76

## COMPREHENSIVE PROBLEMS

**C9.1** The converging-diverging nozzle in the figure has a design Mach number of 2.0 at the exit plane for isentropic flow from tank *a* to *b*. (a) Find the exit area  $A_e$  and back pressure  $p_b$  which will allow design conditions. (b) The back pressure grows as tank *b* fills with air, until a normal shock wave appear in the exit plane. At what back pressure does this occur? (c) If tank *b* remains at constant  $T = 20^\circ\text{C}$ , how long will it take for the flow to go from condition (a) to condition (b)?

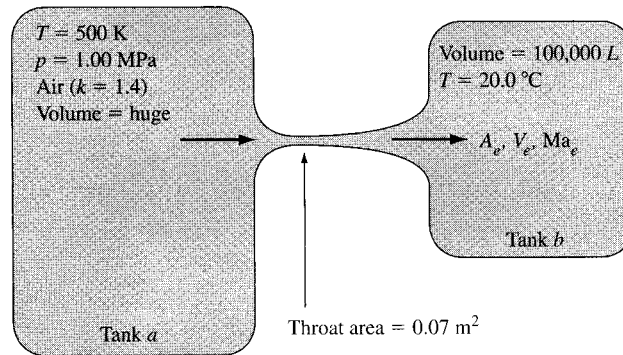


Fig. C9.1

**Solution:** (a) Compute the isentropic pressure ratio and area ratio for  $Ma = 2.0$ :

$$Ma_e = 2.0: \text{Table B.1: } \frac{p_e}{p_o} = 0.1278, \quad p_e = 0.1278(1\text{E}6) = \mathbf{128,000 \text{ Pa}} \quad \text{Ans. (a)}$$

$$\frac{A_e}{A^*} = 1.6875, \quad A_e = 1.6875(0.07) = \mathbf{0.118 \text{ m}^2} \quad \text{Ans. (a)}$$

(b) Compute the pressure ratio across a shock for  $Ma = 2.0$ :

$$Ma_e = 2.0: \text{Table B.2: } \frac{p_b}{p_e} = 4.5, \quad p_b = 4.5(128000) = \mathbf{575,000 \text{ Pa}} \quad \text{Ans. (b)}$$

(c) Compute the (constant) mass flow and the mass needed to fill the tank:

$$\dot{m} = \dot{m}_{\max} = 0.6847 \frac{p_o A^*}{\sqrt{RT_o}} = 0.6847 \frac{(1\text{E}6)(0.07)}{\sqrt{287(500)}} = 126.5 \frac{\text{kg}}{\text{s}} = \text{constant}$$

$$\Delta m_{\text{tank}} = (\rho_{\text{final}} - \rho_{\text{initial}})v_{\text{tank}} = \left[ \frac{575000}{287(293)} - \frac{128000}{287(293)} \right] (100 \text{ m}^3) = 531.9 \text{ kg}$$

Since mass flow is constant, the time required is simply the ratio of these two:

$$\Delta t_{\text{required}} = \frac{\Delta m}{\dot{m}} = \frac{531.9 \text{ kg}}{126.5 \text{ kg/s}} = \mathbf{4.2 \text{ sec}} \quad \text{Ans. (c)}$$

**C9.2** Two large air tanks, one at 400 K and 300 kPa and the other at 300 K and 100 kPa, are connected by a straight tube 6 m long and 5 cm in diameter. The average friction factor is 0.0225. Assuming adiabatic flow, estimate the mass flow through the tube.

**Solution:** The higher-pressure tank denotes the inlet *stagnation* conditions,  $p_o = 300$  kPa and  $T_o = 400$  K. The flow will be subsonic, but we have no idea whether it is choked. Assume that the tube exit pressure equals the receiver pressure, 100 kPa. We must iterate—an ideal job for EES! We *do* know ( $f\Delta L/D$ ):

$$f \frac{\Delta L}{D} = 0.0225 \left( \frac{6.0}{0.05} \right) = 2.70$$

If  $p_2 = 100$  kPa, we must ensure that the inlet Mach number is just sufficient that the inlet stagnation pressure  $p_{o1} = 300$  kPa:

Guess  $Ma_2$ , back off ( $f\Delta L/D$ ) = 2.70, find  $Ma_1$ , check  $p^*$ ,  $p_1$ , and  $p_{o1}$ . Example:

$$Ma_2 = 1.0, \quad p^* = p_2 = 100 \text{ kPa}, \quad f \frac{L_2^*}{D} = 0, \quad f \frac{L_1^*}{D} = 2.70,$$

$$\text{Read } Ma_1 = \mathbf{0.380}, \quad \frac{p_1}{p^*} = 2.84 \quad \text{Then } p_1 = 2.84(100) = 284 \text{ kPa},$$

$$\frac{p_1}{p_{o1}} = [1 + 0.2(0.380)^2]^{-3.5}, \quad \text{solve } p_{o1} = 314 \text{ kPa} \neq 300$$

So we back off and try values of  $Ma_2 < 1.0$  and proceed until the inlet matches. The solution (performed by the author using EES) is

$$Ma_2 = 0.962, \quad Ma_1 = 0.380, \quad p_2 = p^* = 100 \text{ kPa}, \quad p_1 = 271.5 \text{ kPa}, \quad T_1 = 389 \text{ K},$$

$$\rho_1 = 2.434 \frac{\text{kg}}{\text{m}^3}, \quad V_1 = 150 \frac{\text{m}}{\text{s}}, \quad \dot{m} = \rho_1 \frac{\pi}{4} D^2 V_1 = \mathbf{0.718} \frac{\text{kg}}{\text{s}} \quad \text{Ans.}$$

So the tube is *nearly*, but not quite, choked.

**C9.3** Fig. C9.3 shows the exit of a converging-diverging nozzle, where an oblique shock pattern is formed. In the exit plane, which has an area of  $15 \text{ cm}^2$ , the air pressure is 16 kPa and the temperature is 250 K. Just outside the exit shock, which makes an angle of  $50^\circ$  with the exit plane, the temperature is 430 K. Estimate (a) the mass flow; (b) the throat area; (c) the turning angle of the exit flow; and, in the tank supplying the air, (d) the pressure and (e) the temperature.

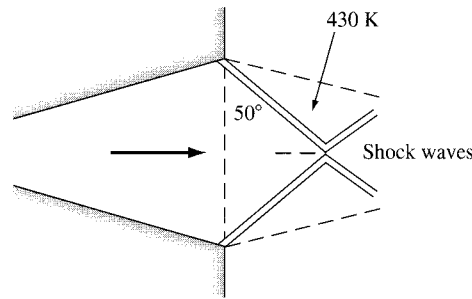


Fig. C9.3

**Solution:** We know the temperature ratio and the shock wave angle, so we can muddle through oblique-shock-wave theory to find the shock conditions:

$$\frac{T_2}{T_1} = \frac{430}{250} = 1.72; \quad \beta = 40^\circ \quad \text{Iterate Eqns. (9.83) or use EES!}$$

$$\text{Solution: } Ma_{exit} = 3.17; \quad \rho_1 = 0.223 \frac{\text{kg}}{\text{m}^3}; \quad \frac{A_1}{A^*} = 4.99 = \frac{15}{A_{throat}}$$

$$A_{throat} = 3.00 \text{ cm}^2 \quad \text{Ans. (b)}$$

$$V_1 = Ma_1 a_1 = 1006 \frac{\text{m}}{\text{s}}, \quad \dot{m} = \rho_1 A_1 V_1 = 0.336 \frac{\text{kg}}{\text{s}} \quad \text{Ans. (a)} \quad \theta_{shock} = 22.88^\circ \quad \text{Ans. (c)}$$

With the exit Mach number known, it is easy to compute stagnation conditions:

$$p_{o,tank} = 16[1 + 0.2(3.17)^2]^{3.5} = 760 \text{ kPa} \quad \text{Ans. (d)}$$

$$T_{o,tank} = 250[1 + 0.2(3.17)^2] = 753 \text{ K} \quad \text{Ans. (e)}$$

**C9.5** Consider one-dimensional steady flow of a non-ideal gas, steam, in a converging nozzle. Stagnation conditions are  $p_o = 100 \text{ kPa}$  and  $T_o = 200^\circ\text{C}$ . The nozzle exit diameter is 2 cm. If the nozzle exit pressure is 70 kPa, (a) calculate the mass flow and the exit temperature for real steam, from the Steam Tables or using EES. (As a first estimate, assume steam to be an ideal gas from Table A.4.) Is the flow choked? Why is EES unable to estimate the exit Mach number? (b) Find the nozzle exit pressure and mass flow for which the steam flow is choked, using EES or the Steam Tables.

**Solution:** (a) For steam as an ideal gas, from Table A.4,  $k = 1.33$  and  $R = 461 \text{ J/kg}\cdot\text{K}$ . First use this approximation to find the exit Mach number:

$$\frac{p}{p_o} = \frac{70 \text{ kPa}}{100 \text{ kPa}} \approx \left(1 + \frac{0.33}{2} Ma_e^2\right)^{-1.33/0.33}, \quad \text{solve for } Ma_{exit} \approx 0.75 \quad \text{Flow is not choked}$$



For real steam, we use EES. The nice Power-law ideal-gas formulas, Eqs. (9.26–9.28), are invalid, but the energy equation (9.22) is valid, and the nozzle flow is isentropic. First evaluate

$$h_o = \text{ENTHALPY}(\text{steam}, p = 100, T = 473) = 2875 \text{ kJ/kg}\cdot\text{K}$$

$$s_o = \text{ENTROPY}(\text{steam}, p = 100, T = 473) = 7.833 \text{ kJ/kg}\cdot\text{K}$$

Then use the energy equation with the known pressure at the exit:

$$h_o = 2875 = h_e + \frac{V_e^2}{2(1000)} \quad \text{with } h_e = \text{ENTHALPY}(\text{steam}, p = 70, s = 7.833)$$

$$\text{EES returns the result } h_e = 2800 \text{ kJ/kg} \quad \text{and} \quad V_e = 385 \text{ m/s}$$

The specific request was for the exit temperature and the mass flow:

$$T_e = \text{TEMPERATURE}(\text{steam}, p = 70, s = 7.833) = \mathbf{434 \text{ K}} \quad \text{Ans. (a)}$$

$$\rho_e = \text{DENSITY}(\text{steam}, p = 70, s = 7.833) = 0.351 \text{ kg/m}^3$$

$$\text{mass flow} = \rho_e A_e V_e = (0.351 \text{ kg/m}^3)(\pi/4)(0.02 \text{ m})^2(385 \text{ m/s}) = \mathbf{0.0425 \text{ kg/s}} \quad \text{Ans. (a)}$$

EES cannot calculate Mach numbers directly because it does not contain the speed of sound. However, we can estimate  $a_e \approx \sqrt{(\delta p / \delta \rho)_{s=s_o}}$  by evaluating density slightly above and below  $p_e$ , with the result  $a_e \approx 513 \text{ m/s}$ . Hence  $Ma_e \approx 385/513 \approx \mathbf{0.75}$  (the same as the ideal gas!).

(b) We are asked to determine  $p_e$  for which the flow *is* choked, using EES. Ideal gas theory for  $k \approx 1.33$  predicts from Eq. (9.32) that  $p^*/p_o \approx 0.54$ . For EES, real steam, we use the same procedure as in part (a) above and reduce  $p_{\text{exit}}$  gradually until the mass flow is a maximum. The final result is

$$p_e/p_o = 0.542, \quad Ma_e \approx 1.00, \quad \dot{m}_{\text{max}} = \mathbf{0.04517 \text{ kg/s}} \quad \text{Ans. (b)}$$

**C9.6** Extend Prob. C9.5 as follows. Let the nozzle be converging-diverging, with an exit diameter of 3 cm. Assume isentropic flow. (a) Find the exit Mach number, pressure, and temperature for an ideal gas, from Table A.4. Does the mass flow agree the value of 0.0452 kg/s in Prob. C9.5? (b) Investigate, briefly, the use of EES for this problem and explain why part (a) is unrealistic and poor convergence of EES is obtained. [HINT: Study the pressure and temperature state predicted by part (a).]

**Solution:** (a) For steam as an ideal gas, from Table A.4,  $k = 1.33$  and  $R = 461 \text{ J/kg}\cdot\text{K}$ .

$$\frac{A_{exit}}{A^*} = \frac{(\pi/4)(0.03)^2}{(\pi/4)(0.02)^2} = 2.25 = \frac{1}{Ma_e} \left\{ \frac{[1 + 0.5(k-1)Ma_e^2]}{0.5(k+1)} \right\}^{0.5(k+1)/(k-1)} \quad \text{for } k = 1.33$$

Solve for  $\mathbf{Ma_e = 2.27}$  Ans. (a)

For the exit pressure, temperature, and mass flow, use the ideal Power-law relations:

$$T_e = T_o / [1 + 0.5(k-1)Ma_e^2] = 473 / [1 + 0.165(2.27)^2] = \mathbf{256 \text{ K}} \quad \text{Ans. (a)}$$

$$p_e = p_o / [1 + 0.5(k-1)Ma_e^2]^{k/(k-1)} = 100 / [1 + 0.165(2.27)^2]^{4.03} = \mathbf{8.4 \text{ kPa}} \quad \text{Ans. (a)}$$

$$\rho_e = \frac{p_e}{RT_e} = 0.0713 \frac{\text{kg}}{\text{m}^3}; \quad V_e = Ma_e a_e = 898 \frac{\text{m}}{\text{s}}; \quad \dot{m} = \rho_e A_e V_e = \mathbf{0.0452 \text{ kg/s}} \quad \text{Ans. (a)}$$

The mass flow does equal the choked-flow value from Prob. C9.5, as expected.

(b) Recall from Prob. C9.5 that  $p_o = 100 \text{ kPa}$  and  $T_o = 200^\circ\text{C}$ , which corresponds for real steam (EES) to  $h_o = 2875 \text{ kJ/kg}\cdot\text{K}$  and  $s_o = 7.833 \text{ kJ/kg}$ . We proceed through the nozzle, using the energy equation,  $h_o = h + V^2/2$ , plus the condition of constant entropy. We also know that the flow is choked at  $0.0452 \text{ kg/s}$  with a throat diameter of  $2 \text{ cm}$ . The results are, for real steam,

$$\mathbf{Ma_e = 2.22; \quad p_e = 10.2 \text{ kPa; \quad } T_e = 319 \text{ K; \quad } \rho_e = 0.0725 \text{ kg/m}^3; \quad \text{Quality} = \mathbf{96\%}}$$

The ideal-gas theory is still reasonably accurate at this point, but it is unrealistic, since the real steam has entered the *two-phase (wet) region*.

**C9.7** Professor Gordon Holloway and his student, Jason Bettle, of the University of New Brunswick, obtained the following tabulated data for blow-down air flow through a converging-diverging nozzle similar in shape to Fig. P3.22. The supply tank pressure and temperature were  $29 \text{ psig}$  and  $74^\circ\text{F}$ , respectively. Atmospheric pressure was  $14.7 \text{ psia}$ . Wall pressures and centerline stagnation pressures were measured in the expansion section, which was a frustum of a cone. The nozzle throat is at  $x = 0$ .

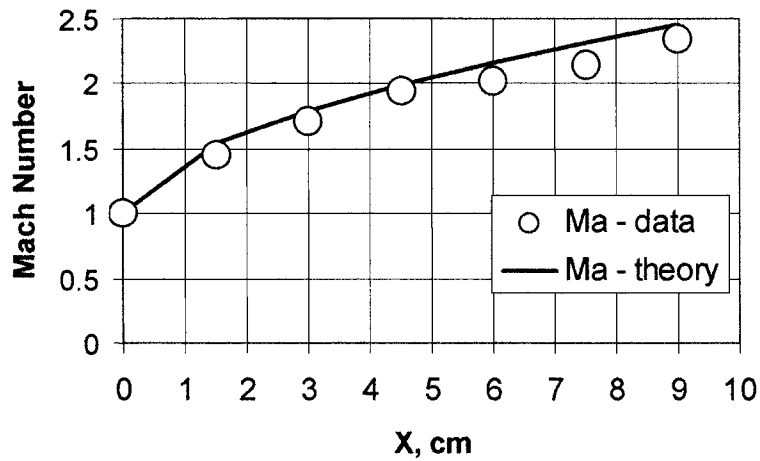
$x$ (cm):	0	1.5	3	4.5	6	7.5	9
Diameter (cm):	1.00	1.098	1.195	1.293	1.390	1.488	1.585
$p_{\text{wall}}$ (psig):	7.7	-2.6	-4.9	-7.3	-6.5	-10.4	-7.4
$p_{\text{stagnation}}$ (psig):	29	26.5	22.5	18	16.5	14	10

Use the stagnation pressure data to estimate the local Mach number. Compare the measured Mach numbers and wall pressures with the predictions of one-dimensional theory. For  $x > 9$  cm, the stagnation pressure data was not thought by Holloway and Bettle to be a valid measure of Mach number. What is the probable reason?

**Solution:** From the cone's diameters we can determine  $A/A^*$  and compute theoretical Mach numbers and pressures from Table B.1. From the measured stagnation pressures we can compute measured (supersonic) Mach numbers, because a normal shock forms in front of the probe. The ratio  $p_{o2}/p_{o1}$  from Eq. (9.58) or Table B.2 is used to estimate the Mach number.

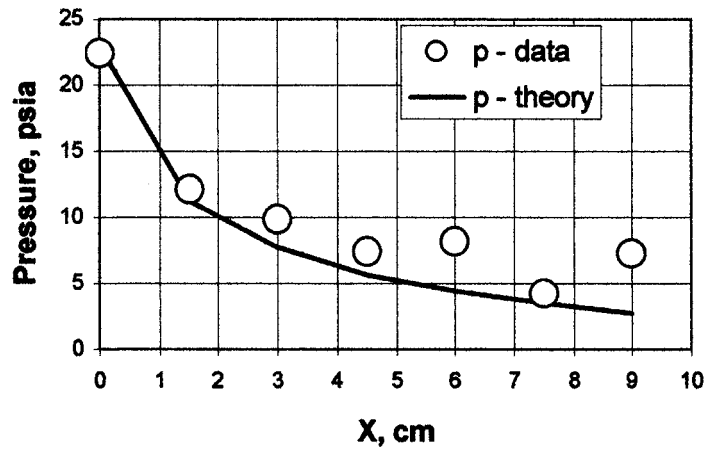
$x$ (cm):	0	1.5	3	4.5	6	7.5	9
Ma-theory:	1.00	1.54	1.79	1.99	2.16	2.31	2.45
$p_w$ -theory (psia):	23.1	11.2	7.72	5.68	4.36	3.44	2.77

The comparison of measured and theoretical Mach number is shown in the graph below.



Problem C9.7

The comparison of measured and theoretical static pressure is shown in the graph below.



Holloway and Bettle discounted the data for  $x > 9$  cm, which gave Mach numbers and pressures widely divergent from theory. It is probably that a normal shock formed in the duct.

---

## Chapter 10 • Open Channel Flow

**10.1** The formula for shallow-water wave propagation speed, Eq. (10.9) or (10.10), is independent of the physical properties of the liquid, i.e., density, viscosity, or surface tension. Does this mean that waves propagate at the same speed in water, mercury, gasoline, and glycerin? Explain.

**Solution:** The shallow-water wave formula,  $c_o = \sqrt{gy}$ , is valid for any fluid except for *viscosity and surface tension effects*. If the wave is very small, or “capillary” in size, its propagation may be influenced by surface tension and Weber number [Ref. 5–7]. If the fluid is very viscous, its speed may be influenced by Reynolds number. The formula is accurate for water, mercury, and gasoline but would be inaccurate for *glycerin*.

---

**10.2** A shallow-water wave 12 cm high propagates into still water of depth 1.1 m. Compute (a) the wave speed; and (b) the induced velocity  $\delta V$ .

**Solution:** The wave is high enough to include the  $\delta y$  terms in Eq. (10.9):

$$\begin{aligned}c &= \sqrt{gy(1 + \delta y/y)(1 + \delta y/2y)} \\ &= \sqrt{9.81(1.1)(1 + 0.12/1.1)[1 + 0.12/\{2(1.1)\}]} = \mathbf{3.55 \text{ m/s}} \quad \text{Ans. (a)} \\ \delta V &= \frac{c\delta y}{y + \delta y} = \frac{(3.55 \text{ m/s})(0.12 \text{ m})}{1.1 + 0.12 \text{ m}} = \mathbf{0.35 \text{ m/s}} \quad \text{Ans. (b)}\end{aligned}$$

---

**10.3** Narragansett Bay is approximately 21 (statute) mi long and has an average depth of 42 ft. Tidal charts for the area indicate a time delay of 30 min between high tide at the mouth of the bay (Newport, Rhode Island) and its head (Providence, Rhode Island). Is this delay correlated with the propagation of a shallow-water tidal-crest wave through the bay? Explain.

**Solution:** If it is a simple shallow-water wave phenomenon, the time delay would be

$$\Delta t = \frac{\Delta L}{c_o} = \frac{(21 \text{ mi})(5280 \text{ ft/mi})}{\sqrt{32.2(42)}} \approx 3015 \text{ s} \approx \mathbf{50 \text{ min}} \quad \text{Ans.???$$

This doesn't agree with the measured  $\Delta t \approx 30$  min. In reality, tidal propagation in estuaries is a *dynamic* process, dependent on estuary shape, bottom friction, and tidal period.

---

**10.4** The water-channel flow in Fig. P10.4 has a free surface in three places. Does it qualify as an open-channel flow? Explain. What does the dashed line represent?

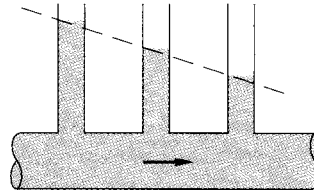


Fig. P10.4

**Solution:** No, this is *not* an open-channel flow. The open tubes are merely piezometer or pressure-measuring devices, there is no flow in them. The dashed line represents the pressure distribution in the tube, or the “hydraulic grade line” (HGL).

**10.5** Water flows rapidly in a channel 25 cm deep. Piercing the surface with a pencil point creates a wedge-like wave of included angle  $38^\circ$ , as shown. Estimate the velocity  $V$  of the water flow.

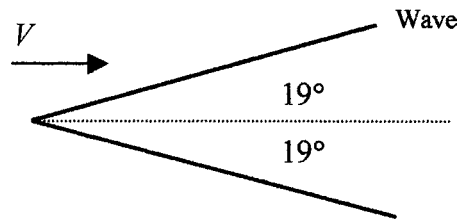


Fig. P10.5

**Solution:** This is a “supercritical” flow, analogous to supersonic gas flow. The Froude number is analogous to Mach number here:

$$\sin \theta = \sin(19^\circ) = \frac{1}{Fr} = \frac{c}{V} = \frac{\sqrt{gy}}{V} = \frac{\sqrt{(9.81 \text{ m/s}^2)(0.25 \text{ m})}}{V},$$

$$\text{Solve } V = 4.81 \frac{\text{m}}{\text{s}} \quad \text{Ans. (Fr = 3.1)}$$

**10.6** Pebbles dropped successively at the same point, into a water-channel flow of depth 42 cm, create two circular ripples, as in Fig. P10.6. From this information, estimate (a) the Froude number; and (b) the stream velocity.

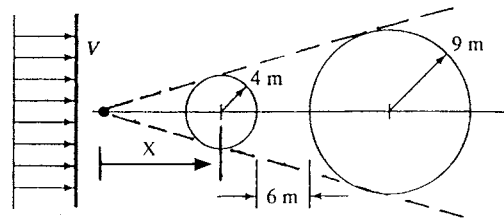


Fig. P10.6

**Solution:** The center of each circle moves at stream velocity  $V$ . For the small circle,

$$\text{small circle: } X = \frac{4V}{c_o}; \quad \text{large circle: } X + 4 + 6 + 9 = \frac{9V}{c_o};$$

$$\text{Solve } Fr = \frac{V}{c_o} = 3.8 \quad \text{Ans. (a)}$$

$$\text{Compute } c_o = \sqrt{gh} = \sqrt{9.81(0.42)} = 2.03 \frac{\text{m}}{\text{s}}, \quad V_{\text{current}} = 3.8c_o \approx 7.7 \frac{\text{m}}{\text{s}} \quad \text{Ans. (b)}$$

**10.7** Pebbles dropped successively at the same point, into a water-channel flow of depth 65 cm, create two circular ripples, as in Fig. P10.7. From this information, estimate (a) the Froude number; and (b) the stream velocity.

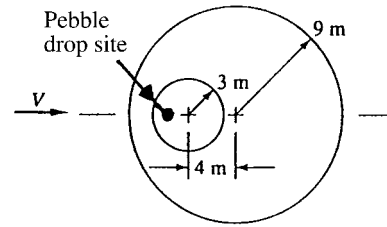


Fig. P10.7

**Solution:** If the pebble-drop-site is at distance  $X$  ahead of the small-circle center,

$$\text{small circle: } X = \frac{3V}{c_o}; \quad \text{large circle: } X + 4 = \frac{9V}{c_o}; \quad \text{solve } \mathbf{Fr} = \frac{V}{c_o} = \frac{2}{3} \quad \text{Ans. (a)}$$

$$c_o = \sqrt{gh} = \sqrt{9.81(0.65)} = 2.53 \frac{\text{m}}{\text{s}}; \quad \mathbf{V}_{\text{current}} = \frac{2}{3}c_o \approx \mathbf{1.68} \frac{\text{m}}{\text{s}} \quad \text{Ans. (b)}$$

**10.8** An earthquake near the Kenai Peninsula, Alaska, creates a single “tidal” wave (called a ‘tsunami’) which propagates south across the Pacific Ocean. If the average ocean depth is 4 km and seawater density is  $1025 \text{ kg/m}^3$ , estimate the time of arrival of this tsunami in Hilo, Hawaii.

**Solution:** Everyone get out your Atlases, how far is it from Kenai to Hilo? Well, it’s about 2800 statute miles (4480 km), and seawater *density* has nothing to do with it:

$$\Delta t_{\text{travel}} = \frac{\Delta x}{c_o} = \frac{4480 \text{E}3 \text{ m}}{\sqrt{9.81(4000 \text{ m})}} \approx 22600 \text{ s} \approx \mathbf{6.3 \text{ hours}} \quad \text{Ans.}$$

So, given warning of an earthquake in Alaska (by a seismograph), there is plenty of time to warn the people of Hilo (which is very susceptible to tsunami damage) to take cover.

**10.9** Equation (10.10) is for a single disturbance wave. For *periodic* small-amplitude surface waves of wavelength  $\lambda$  and period  $T$ , inviscid theory [5 to 9] predicts a wave propagation speed

$$c_0^2 = \frac{g\lambda}{2\pi} \tanh \frac{2\pi y}{\lambda}$$

where  $y$  is the water depth and surface tension is neglected. (a) Determine if this expression is affected by the Reynolds number, Froude number, or Weber number. Derive the limiting values of this expression for (b)  $y \ll \lambda$  and (c)  $y \gg \lambda$ . (d) Also for what ratio  $y/\lambda$  is the wave speed within 1 percent of limit (c)?

**Solution:** (a) Obviously there is **no effect** in this theory for Reynolds number or Weber number, because viscosity and surface tension are not present in the formula. There *is* a Froude number effect, and we can rewrite it as Froude number versus dimensionless depth:

$$\mathbf{Fr}_{\text{wave}} = \frac{c_o}{\sqrt{g\lambda}} = \sqrt{\frac{1}{2\pi} \tanh\left(\frac{2\pi y}{\lambda}\right)} = \mathbf{fcn}\left(\frac{y}{\lambda}\right) \quad \text{Ans. (a)}$$

(b)  $y \leq \lambda$ :  $\tanh \zeta \approx \zeta$  if  $\zeta \ll 1$ :  $c_{o,\text{long waves}}^2 \approx \frac{g\lambda}{2\pi} \frac{2\pi y}{\lambda} \approx \mathbf{gy}$  (same as Eq. 10.10) *Ans. (b)*

(c)  $y \gg \lambda$ :  $\tanh \zeta \approx 1$  if  $\zeta \gg 1$ :  $c_{o,\text{short waves}}^2 \approx \frac{g\lambda}{2\pi}$  (periodic **deep-water** waves) *Ans. (c)*

(d)  $c_o = 0.99c_{o,\text{deep}}$  if  $\tanh(2\pi y/\lambda) \approx 0.995 \approx \tanh(3)$ , or  $y/\lambda \approx \mathbf{0.48}$ . *Ans. (d)*

**10.10** If surface tension  $U$  is included in the analysis of Prob. 10.9, the resulting wave speed is [Refs. 5 to 9]:

$$c_0^2 = \left( \frac{g\lambda}{2\pi} + \frac{2\pi Y}{\rho\lambda} \right) \tanh \frac{2\pi y}{\lambda}$$

- (a) Determine if this expression is affected by the Reynolds number, Froude number, or Weber number. Derive the limiting values of this expression for (b)  $y \ll \lambda$  and (c)  $y \gg \lambda$ .  
 (d) Finally determine the wavelength  $\lambda_{\text{crit}}$  for a minimum value of  $c_0$ , assuming that  $y \gg \lambda$ .

**Solution:** (a) Obviously there is **no effect** in this theory for Reynolds number, because viscosity is not present in the formula. There *are* Froude number and Weber number effects, and we can rewrite it as Froude no. versus Weber no. and dimensionless depth:

$$\mathbf{Fr}_{\text{wave}} = \frac{c_o}{\sqrt{g\lambda}} = \sqrt{\left( \frac{1}{2\pi} + \frac{2\pi Y}{\rho g \lambda^2} \right) \tanh\left(\frac{2\pi y}{\lambda}\right)} = \mathbf{fcn}\left(\mathbf{We}, \frac{y}{\lambda}\right), \quad \mathbf{We} = \frac{\rho g \lambda^2}{Y} \quad \text{Ans. (a)}$$

(b)  $y \ll \lambda$ :  $\tanh \zeta \approx \zeta$  if  $\zeta \ll 1$ :  $c_{o,\text{long waves}}^2 \approx \left( \mathbf{gy} + \frac{4\pi^2 Y y}{\rho \lambda^2} \right)$  *Ans. (b)*

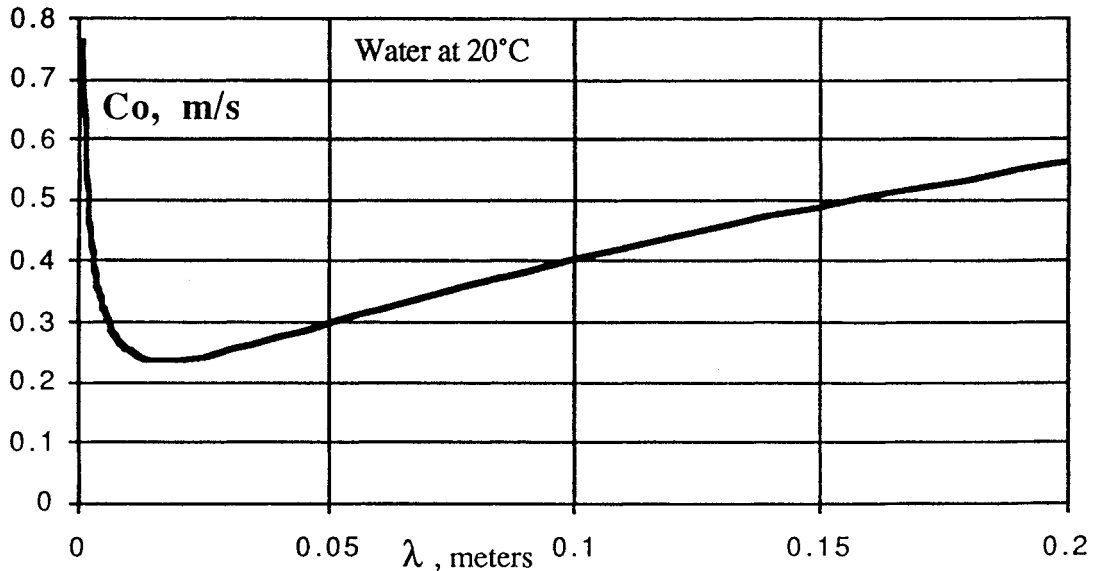
(c)  $y \gg \lambda$ :  $\tanh \zeta \approx 1$  if  $\zeta \gg 1$ :  $c_{o,\text{short waves}}^2 \approx \left( \frac{g\lambda}{2\pi} + \frac{2\pi Y}{\rho\lambda} \right)$  *Ans. (c)*



For a deep-water wave, part (c) applies, and we can differentiate with respect to  $\lambda$ :

$$\frac{dc_o^2}{d\lambda} = \frac{g}{2\pi} - \frac{2\pi Y}{\rho\lambda^2} = 0 \quad \text{if} \quad \lambda_{\text{crit}} = 2\pi \sqrt{\frac{Y}{\rho g}} \quad (\text{where } c_o = c_{o,\text{min}}) \quad \text{Ans. (d)}$$

For water at 20°C, we may compute that  $\lambda_{\text{crit}} \approx 0.018 \text{ m} = 1.8 \text{ cm}$ , as shown below.



**10.11** A rectangular channel is 2 m wide and contains water 3 m deep. If the slope is  $0.85^\circ$  and the lining is corrugated metal, estimate the discharge for uniform flow.

**Solution:** For corrugated metal, take Manning's  $n \approx 0.022$ . Get the hydraulic radius:

$$R_h = \frac{A}{P} = \frac{2(3)}{3+2+3} = 0.75 \text{ m}; \quad Q \approx \frac{1}{n} A R_h^{2/3} S_o^{1/2} = \frac{1}{0.022} (6)(0.75)^{2/3} [\tan(0.85^\circ)]^{1/2}$$

$$\text{or: } Q \approx 27 \text{ m}^3/\text{s} \quad \text{Ans.}$$

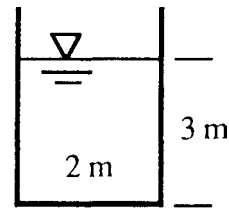


Fig. P10.11

**10.12** (a) For laminar draining of a wide thin sheet of water on pavement sloped at angle  $\theta$ , as in Fig. P4.36, show that the flow rate is given by

$$Q = \frac{\rho g b h^3 \sin \theta}{3\mu}$$

where  $b$  is the sheet width and  $h$  its depth. (b) By (somewhat laborious) comparison with Eq. (10.13), show that this expression is compatible with a friction factor  $f = 24/\text{Re}$ , where  $\text{Re} = V_{\text{av}}h/\nu$ .

**Solution:** The velocity and flow rate were worked out in detail in Prob. 4.36:

$$\text{x-Mom. yields } u = \frac{\rho g \sin \theta}{2\mu} y(2h - y), \quad Q = \int_0^h u b dy = \frac{\rho g b h^3 \sin \theta}{3\mu} \quad \text{Ans. (a)}$$

$$\text{for } 0 < y < h. \text{ Then } V_{\text{avg}} = \frac{2}{3} u_{\text{max}} = \frac{h^2 g \sin \theta}{3\nu} \quad \text{and} \quad R_h |_{\text{wide channel}} \approx h$$

Interpreting “ $\sin \theta$ ” as “ $S_o$ ,” the channel slope, we compare  $Q$  above with Eq. 10.13:

$$Q = \frac{g b h^3 S_o}{3\nu} = \sqrt{\frac{8g}{f}} (bh) h^{1/2} S_o^{1/2}, \quad \text{solve for } f = \frac{72\nu^2}{g h^3 S_o} = \frac{24\nu}{V_{\text{avg}} h} = \frac{24}{\text{Re}} \quad \text{Ans.}$$

**10.13** The laminar-draining flow from Prob. 10.12 may undergo transition to turbulence if  $\text{Re} > 500$ . If the pavement slope is 0.0045, what is the maximum sheet thickness, in mm, for which laminar flow is ensured?

**Solution:** For water at 20°C, take  $\rho = 998 \text{ kg/m}^3$  and  $\mu = 0.001 \text{ kg/m}\cdot\text{s}$ . Define the Reynolds number as in Prob. 10.12 above:

$$\text{Re} = \frac{V_{\text{avg}} h}{\nu}, \quad \text{where } V_{\text{avg}} = \frac{g h^2 S_o}{3\nu}, \quad \text{thus } \text{Re} < 500 \quad \text{if } \frac{g h^3 S_o}{3\nu^2} < 500,$$

$$\text{or: } h^3 < \frac{3(0.001/998)^2(500)}{9.81(0.0045)} \quad \text{or: sheet depth } h \leq 0.0032 \text{ m} \quad \text{Ans.}$$

**10.14** The Chézy formula (10.18) is independent of fluid density and viscosity. Does this mean that water, mercury, alcohol, and SAE 30 oil will all flow down a given open channel at the same rate? Explain.

**Solution:** The Chézy formula,  $V = (1.0/n)(R_h)^{2/3} \sqrt{S_o}$ , appears to be independent of fluid properties, with  $n$  only representing surface roughness, but in fact it requires that the channel flow be “fully rough” and turbulent, i.e., at high Reynolds number  $\geq 1\text{E}6$  at least. Even for low-viscosity fluids such as water, mercury, and alcohol, this requires reasonable

**size** for the channel,  $R_h$  of the order of 1 meter or more if the slope is small ( $S_o \ll 1$ ). SAE 30 oil is so viscous that it would need  $R_h > 10$  m to approach the Chézy formula.

**10.15** The finished-concrete channel of Fig. P10.15 is designed for a flow rate of  $6 \text{ m}^3/\text{s}$  at a normal depth of 1 m. Determine (a) the design slope of the channel and (b) the percentage of reduction in flow if the surface is asphalt.

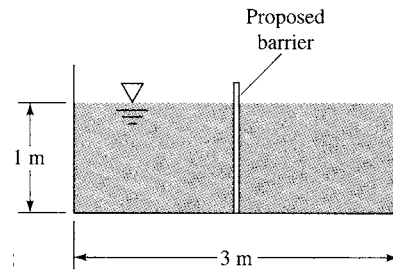


Fig. P10.15

**Solution:** For finished concrete,  $n \approx 0.012$ . Evaluate the hydraulic radius and then  $S_o$ :

$$R_h = \frac{A}{P} = \frac{3 \text{ m}^2}{5 \text{ m}} = 0.6 \text{ m}, \quad \text{Chézy: } Q = 6 \frac{\text{m}^3}{\text{s}} = \frac{1.0}{0.012} (3)(0.6)^{2/3} S_o^{1/2},$$

$$S_o \approx \mathbf{0.00114} \quad \text{Ans. (a)}$$

$$\text{(b) Asphalt: } n \approx 0.016, \quad \therefore Q = 6 \frac{n_1}{n_2} = 6 \left( \frac{0.012}{0.016} \right) \approx \mathbf{4.5 \frac{\text{m}^3}{\text{s}}} \quad (25\% \text{ less}) \quad \text{Ans. (b)}$$

**10.16** In Prob. 10.15, for finished concrete, determine the percentage reduction in flow if the channel is divided in the center by the proposed barrier in Fig. P10.15 above. How does your estimate change if all surfaces are clay tile?

**Solution:** For any given  $n$ , we are simply comparing one large to two small channels:

$$\frac{Q_{2 \text{ small}}}{Q_{1 \text{ large}}} = \frac{2(1/n)(1.5)(1.5/3.5)^{2/3} S_o^{1/2}}{(1/n)(3.0)(3/5)^{2/3} S_o^{1/2}} = \left[ \frac{R_{h,\text{small}}}{R_{h,\text{large}}} \right]^{2/3} = \left( \frac{3/7}{3/5} \right)^{2/3} \approx \mathbf{0.80} \quad (20\% \text{ less}) \quad \text{Ans.}$$

Since  $n$  is the same for each, this result is independent of the surface—clay tile, etc.

**10.17** The trapezoidal channel of Fig. P10.17 is made of brickwork and slopes at 1:500. Determine the flow rate if the normal depth is 80 cm.

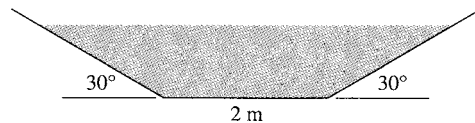


Fig. P10.17

**Solution:** For brickwork,  $n \approx 0.015$ . Evaluate the hydraulic radius with  $y = 0.8$  m:

$$A = 2y + y^2 \cot \theta = 2(0.8) + (0.8)^2 \cot 30^\circ = 2.71 \text{ m}^2$$

$$P = 2 + 2(0.8) \csc 30^\circ = 5.2 \text{ m}, \quad R_h = A/P = 2.71/5.2 \approx 0.521 \text{ m}$$

$$Q = \frac{1.0}{n} AR_h^{2/3} S_o^{1/2} = \frac{1.0}{0.015} (2.71)(0.521)^{2/3} \left( \frac{1}{500} \right)^{1/2} \approx \mathbf{5.23 \text{ m}^3/\text{s}} \quad \text{Ans.}$$

**10.18** Modify Prob. 10.17 as follows: Determine the normal depth for which the flow rate will be  $8 \text{ m}^3/\text{s}$ .

**Solution:** We must iterate to find the depth  $y$  for this flow rate. We know  $y > 0.8 \text{ m}$ :

$$Q = 8 \frac{\text{m}^3}{\text{s}} \stackrel{?}{=} \frac{1.0}{0.015} (2y + y^2 \cot 30^\circ) \left[ \frac{2y + y^2 \cot 30^\circ}{2 + 2y \csc 30^\circ} \right]^{2/3} \left( \frac{1}{500} \right)^{1/2}$$

Guess  $y = 1 \text{ m}$ ,  $Q = 8.11 \text{ m}^3/\text{s}$ , drop down, converge to  $y \approx \mathbf{0.993 \text{ m}}$  Ans.

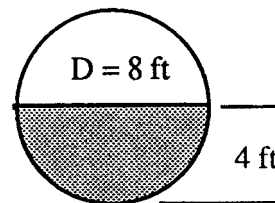
**10.19** Modify Prob. 10.17 as follows: Let the surface be clean earth, which erodes if  $V$  exceeds  $1.5 \text{ m/s}$ . What is the maximum depth to avoid erosion?

**Solution:** For clean earth,  $n \approx 0.022$ . Guess  $y$  and iterate to find  $V \approx 1.5 \text{ m/s}$ :

$$\text{Guess } y \approx 0.8 \text{ m}, A = 2.71 \text{ m}^2, R_h = 0.521 \text{ m}, V = \frac{1.0}{0.022} (0.521)^{2/3} \left( \frac{1}{500} \right)^{1/2} \approx 1.32 \text{ m/s}$$

Try  $y \approx 1.0 \text{ m}$  to get  $V \approx 1/48 \text{ m/s}$ , move up slightly to  $y < \mathbf{1.025 \text{ m}}$  Ans.

**10.20** A circular corrugated-metal storm drain is flowing half-full over a slope of  $4 \text{ ft/mile}$ . Estimate the normal discharge if the drain diameter is  $8 \text{ ft}$ .



**Fig. P10.20**

**Solution:** For corrugated metal,  $n \approx 0.022$ . Evaluate the hydraulic radius, etc.:

$$A = (\pi/2)R^2 = 25.13 \text{ ft}^2; \quad P = \pi R = 12.56 \text{ ft}, \quad R_h = A/P = R/2 = 2 \text{ ft}$$

$$Q = \frac{1.486}{n} AR_h^{2/3} S_o^{1/2} = \frac{1.486}{0.022} (25.13)(2.0)^{2/3} \left( \frac{4}{5280} \right)^{1/2} \approx \mathbf{74 \frac{\text{ft}^3}{\text{s}}} \quad \text{Ans.}$$

**10.21** An engineer makes careful measurements with a weir (see Sect. 10.7 later) which monitors a rectangular unfinished concrete channel laid on a slope of  $1^\circ$ . She finds, perhaps with surprise, that when the water depth doubles from 2 ft 2 inches to 4 ft 4 inches, the normal flow rate more than doubles, from 200 to 500  $\text{ft}^3/\text{s}$ . (a) Is this plausible? (b) If so, estimate the channel width.

**Solution:** (a) **Yes**,  $Q$  always more than doubles for this situation where the depth doubles. *Ans.* (a)

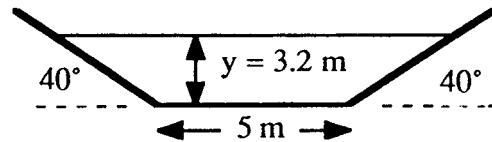
(b) For unfinished concrete, take  $n = 0.014$ . Apply the normal-flow formula (10.19) to this data:

$$Q = \frac{1.486}{n} AR_h^{2/3} S_o^{1/2} = \frac{1.486}{0.014} (bh) \left( \frac{bh}{b+2h} \right)^{2/3} \sqrt{\sin 1^\circ} = 200(\text{or } 500) \frac{\text{ft}^3}{\text{s}}$$

if  $h = 2.17(\text{or } 4.33)\text{ft}$

The two pieces of flow rate data give us two equations to solve for width  $b$ . It is unusual, but true, that both round-number flow rates converge to the same width  $b = 5.72 \text{ ft}$ . *Ans.* (b)

**10.22** A trapezoidal aqueduct has  $b = 5 \text{ m}$  and  $\theta = 40^\circ$  and carries a normal flow of  $60 \text{ m}^3/\text{s}$  when  $y = 3.2 \text{ m}$ . For clay tile surfaces, estimate the required elevation drop in  $\text{m}/\text{km}$ .



**Fig. P10.22**

**Solution:** For clay tile, take  $n \approx 0.014$ . The geometry leads to these values:

$$A = by + y^2 \cot \theta = 28.2 \text{ m}^2; \quad P = b + 2y \csc \theta = 14.96 \text{ m}, \quad R_h = A/P = 1.886 \text{ m}$$

$$Q = 60 \text{ m}^3/\text{s} = \frac{1.0}{0.014} (28.2)(1.886)^{2/3} S_o^{1/2}, \quad \text{solve for } S_o = 0.00038 = \mathbf{0.38 \text{ m}/\text{km}} \quad \textit{Ans.}$$

**10.23** It is desired to excavate a clean-earth channel as a trapezoidal cross-section with  $\theta = 60^\circ$  (see Fig. 10.7). The expected flow rate is  $500 \text{ ft}^3/\text{s}$ , and the slope is 8 ft per mile. The uniform flow depth is planned, for efficient performance, such that the flow cross-section is half a hexagon. What is the appropriate bottom width of the channel?

**Solution:** For clean earth, take  $n = 0.022$ . For a half-hexagon, from Fig. 10.7 of the text, depth  $y = \sin(60^\circ)b = 0.866b$ , and

$$A = by + y^2 \cot 60^\circ = b(0.866b) + (0.866b)^2(0.577) = 1.299b^2; \quad P = 3b$$

$$Q = 500 \frac{ft^3}{s} = \frac{1}{n} AR_h^{2/3} S_o^{1/2} = \frac{1.486}{0.022} (1.299b^2) \left( \frac{1.299b^2}{3b} \right)^{2/3} (8/5280)^{1/2} = 1.955b^{8/3}$$

Solve for  $\mathbf{b = 8.0 \text{ ft}}$  Ans.

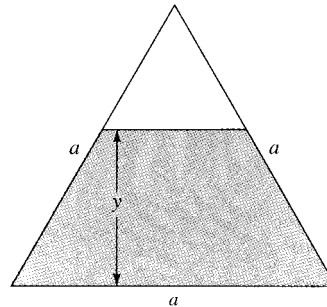
**10.24** A riveted-steel channel slopes at 1:500 and has a Vee shape with an included angle of  $80^\circ$ . Find the normal depth if the flow rate is  $900 \text{ m}^3/\text{h}$ .

**Solution:** For riveted steel take  $n \approx 0.015$ . From Ex. 10.5 (the same included angle),

$$Q = \frac{1}{n} AR_h^{2/3} S_o^{1/2} = \frac{900 \text{ m}^3}{3600 \text{ s}} = \frac{1}{0.015} (y^2 \cot 50^\circ) \left( \frac{y}{2} \cos 50^\circ \right)^{2/3} (1/500)^{1/2},$$

Solve for  $y^{8/3} = 0.213$ , or:  $\mathbf{y_n \approx 0.56 \text{ m}}$  Ans.

**10.25** The equilateral-triangle in Fig. P10.25 has constant slope and Manning factor  $n$ . Find  $Q_{\max}$  and  $V_{\max}$ . Then, by analogy with Fig. 10.6b, plot the ratios  $Q/Q_{\max}$  and  $V/V_{\max}$  as a function of  $y/a$  for the range  $0 < y/a < 0.866$ .



**Fig. P10.25**

**Solution:** The geometry is really not too hard, so we may compute  $V$  and  $Q$  as follows:

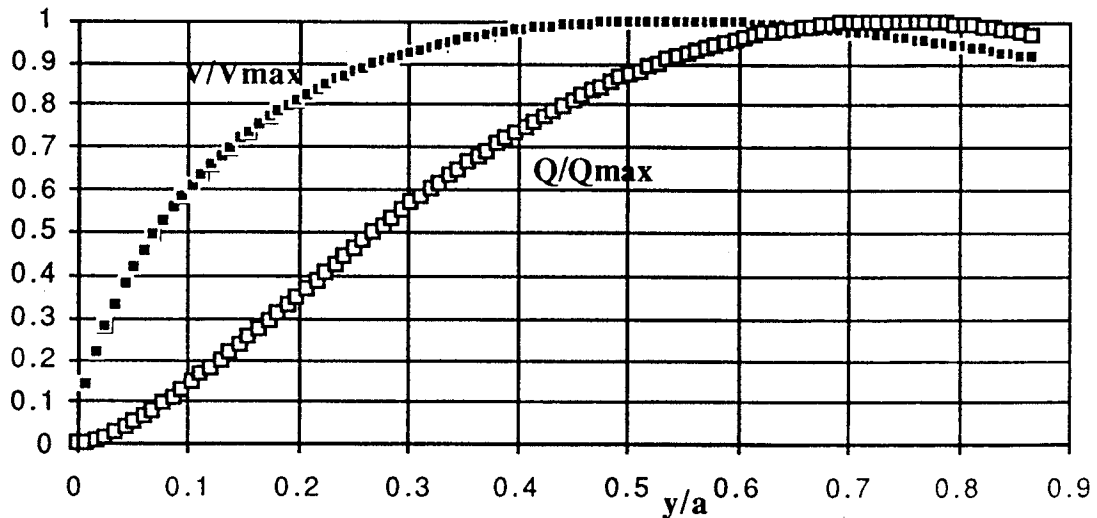
$$V = \frac{1}{n} R_h^{2/3} S_o^{1/2}, \quad \text{where } R_h = \frac{A}{P} \quad \text{and} \quad A = \frac{a^2}{2} \left[ 0.866 - \left( 1 - \frac{y}{0.866a} \right)^2 \right],$$

$$P = a + 2a \left( 1 - \frac{y}{0.866a} \right) \quad \text{and, finally, } Q = VA$$

The maximum velocity and flow-rate values are

$$V_{\max} \approx \mathbf{0.301} \frac{\mathbf{a}^{2/3}}{\mathbf{n}} S_o^{1/2} \quad \text{at } \frac{\mathbf{y}}{\mathbf{a}} \approx 0.54; \quad Q_{\max} \approx \mathbf{0.123} \frac{\mathbf{a}^{8/3}}{\mathbf{n}} S_o^{1/2} \quad \text{at } \frac{\mathbf{y}}{\mathbf{a}} \approx 0.74 \quad \text{Ans.}$$

The desired plots are shown on the following page and resemble Fig. 10.6b in the text.



**10.26** In the spirit of Fig. 10.6b, analyze a rectangular channel in uniform flow with constant area  $A = by$ , constant slope, but varying width  $b$  and depth  $y$ . Plot the resulting flow rate  $Q$ , normalized by its maximum value  $Q_{\max}$ , in the range  $0.2 < b/y < 4.0$ , and comment on whether it is crucial for discharge efficiency to have the channel flow at a depth exactly equal to half the channel width.

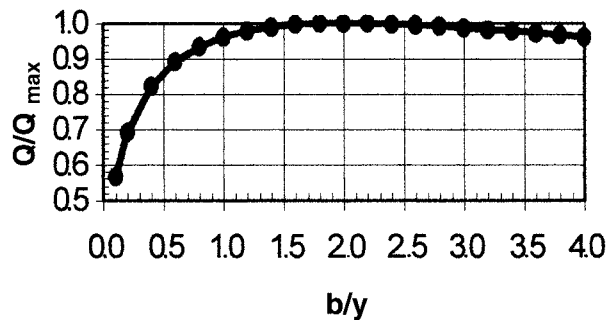
**Solution:** The Manning formula for a rectangular channel is:

$$Q = \frac{\alpha}{n} A R_h^{2/3} S_o^{1/2} \quad \text{where } R_h = \frac{A}{b+2y} \quad \text{and } A = by$$

$$Q = Q_{\max} \quad \text{when } b = 2y, \quad \text{or: } R_h = A/2b$$

$$\text{Then } A \text{ cancels in the ratio } Q/Q_{\max} = [2b/(b+2y)]^{2/3}$$

Plot  $Q/Q_{\max}$  versus  $(b/y)$  making sure that area is constant, that is,  $b = A/y$ . The results are shown in the graph below. The curve is very flat near  $b = 2y$ , so **depth is not crucial**.



Problem 10.26

**10.27** A circular unfinished-cement water channel has a slope of 1:600 and a diameter of 5 ft. Estimate the normal discharge in gal/min for which the average wall shear stress is 0.18 lbf/ft<sup>2</sup>, and compare your result to the maximum possible discharge for this channel.

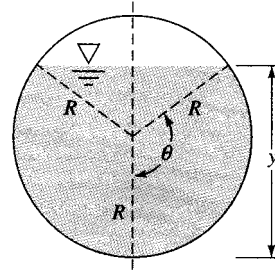


Fig. 10.6 (a)

**Solution:** For unfinished cement, take  $n \approx 0.014$ . From Prob. 10.28, we obtain

$$\tau_o = \rho g R_h S_o, \quad \text{where } R_{h,\text{circle}} = \frac{R}{2} \left( 1 - \frac{\sin 2\theta}{2} \right),$$

$$\text{or: } R_h = \frac{\tau_o}{\rho g S_o} = \frac{0.15 \text{ psf}}{62.4(1/600)} \approx 1.44 \text{ ft}$$

$$\text{Solve } R_h = 1.44 \text{ ft} = \frac{2.5 \text{ ft}}{2} \left[ 1 - \frac{\sin 2\theta}{2} \right] \quad \text{for } \theta \approx \mathbf{108^\circ}, \quad \text{for which } A \approx 13.55 \text{ ft}^2$$

This is below the point of maximum flow rate, which occurs at  $\theta \approx 151^\circ$ . Compute

$$Q = \frac{1.486}{n} A R_h^{2/3} S_o^{1/2} = \frac{1.486}{0.014} (13.55)(1.44)^{2/3} \left( \frac{1}{600} \right)^{1/2} \approx 75 \frac{\text{ft}^3}{\text{s}} \approx \mathbf{33600 \frac{\text{gal}}{\text{min}}} \quad \text{Ans.}$$

This is about **71%** of  $Q_{\max} = 2.219 \left( \frac{1.486}{n} \right) R^{8/3} S_o^{1/2} = 47700 \text{ gal/min}$

**10.28** Show that, for any straight, prismatic channel in uniform flow, the average wall shear stress is given by

$$\tau_{\text{avg}} \approx \rho g R_h S_o$$

Use this result in Prob. 10.27 also.

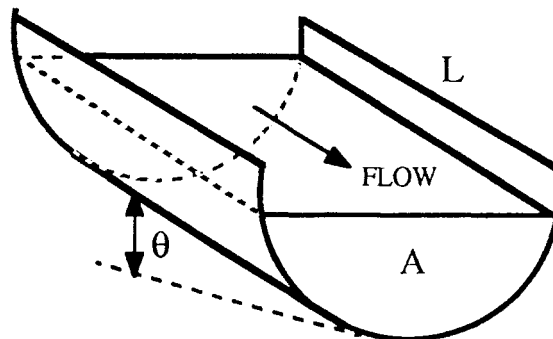


Fig. P10.28



**Solution:** For a control volume enclosing the fluid prism of length  $L$  as shown in the figure,

$$\sum F_{\text{along flow}} = W_{\text{fluid}} \sin \theta - \tau_{\text{avg}} A_{\text{wall}}, \quad \text{or} \quad \tau_{\text{avg}} PL = \rho g AL \sin \theta$$

But  $\sin \theta = S_o$  by definition,  $L$  cancels, leaving  $\tau_{\text{avg}} = \rho g R_h \sin \theta$  *Ans.*

**10.29** Suppose that the trapezoidal channel of Fig. P10.17 contains sand and silt which we wish not to erode. According to an empirical correlation by A. Shields in 1936, the average wall shear stress  $\tau_{\text{crit}}$  required to erode sand particles of diameter  $d_p$  is approximated by

$$\frac{\tau_{\text{crit}}}{(\rho_s - \rho)g d_p} \approx 0.5$$

where  $\rho_s \approx 2400 \text{ kg/m}^3$  is the density of sand. If the slope of the channel in Fig. P10.17 is 1:900 and  $n \approx 0.014$ , determine the maximum water depth to keep from eroding particles of 1-mm diameter.

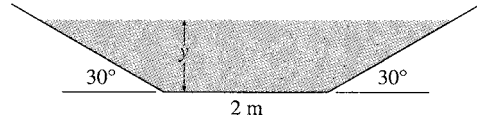


Fig. P10.17

**Solution:** We relate the Shields critical shear stress to our result in Prob. 10.28 above:

$$\tau_{\text{crit}} = 0.5(2400 - 998)(9.81)(0.001 \text{ m}) \approx 6.88 \text{ Pa} = \rho g R_h S_o = (9790) R_h \left( \frac{1}{900} \right)$$

Solve for  $R_{h,\text{crit}} \approx 0.632 \text{ m} = \frac{A}{P}$ , where  $A = by + y^2 \cot 30^\circ$  and  $P = b + 2y \csc 30^\circ$

By iteration ( $b = 2 \text{ m}$ ), we solve for water depth  $y < 1.02 \text{ m}$  to avoid erosion. *Ans.*

**10.30** A clay tile V-shaped channel, with an included angle of  $90^\circ$ , is 1 km long and is laid out on a 1:400 slope. When running at a depth of 2 m, the upstream end is suddenly closed while the lower end continues to drain. Assuming quasi-steady normal discharge, find the time for the channel depth to drop to 20 cm.

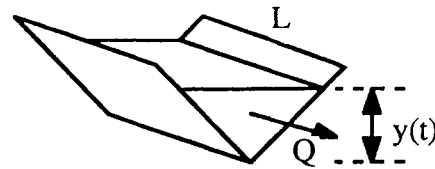


Fig. P10.30

**Solution:** We assume quasi-steady uniform flow at any instant. For a control volume enclosing the entire channel of length  $L = 1$  km, we obtain

$$\frac{d}{dt}(m_{CV}) = -\dot{m}_{out}, \quad \text{or, cancelling } \rho, \quad \frac{d}{dt}(LA) = -Q_{out} = -\frac{1}{n} AR_h^{2/3} S_o^{1/2}$$

For a Vee-channel,  $A = y^2 \cot 45^\circ$  and  $R_h = \frac{y}{2} \cos 45^\circ$ ,  $L = 1000$  m,  $S_o = \frac{1}{400}$

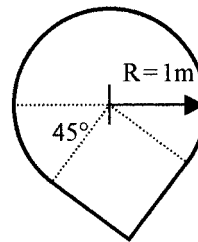
Clean this up, separate the variables, and integrate:

$$\int_{y_0}^y \frac{dy}{y^{5/3}} = -\text{const} \int_0^t dt, \quad \text{or } y_0^{-2/3} - y^{-2/3} = -Ct, \quad \text{where } C = \frac{(1/n)(\cos 45^\circ/2)^{2/3} S_o^{1/2}}{(3/2)L}$$

or:  $C = 0.00119$  for our case. Set  $(2.0)^{-2/3} - (0.2)^{-2/3} = -0.00119 t_{\text{drain}}$

Solve for  $t_{\text{drain}} = 1927$  sec  $\approx$  **32 min** *Ans.*

**10.31** A storm drain has the cross section shown in Fig. P10.31 and is laid on a slope 1.5 m/km. If it is constructed of brickwork, find the normal discharge when the water level passes through the center of the circle.



**Fig. P10.31**

**Solution:** For brickwork take  $n = 0.015$ . The section properties are:

$$A = R^2 \left( 1 + \frac{\pi}{4} \right) = (1 \text{ m})^2 (1 + 0.785) = 1.785 \text{ m}^2; \quad P = \frac{1}{4} (2\pi)(1 \text{ m}) + 1 \text{ m} + 1 \text{ m} = 3.571 \text{ m}$$

$$Q = \frac{1}{0.015} (1.785 \text{ m}^2) \left( \frac{1.785 \text{ m}^2}{3.571 \text{ m}} \right)^{2/3} \sqrt{0.0015} = \mathbf{2.90 \text{ m}^3/\text{s}} \quad \text{Ans.}$$

**10.32** A 2-m-diameter clay tile sewer pipe runs half full on a slope of  $0.25^\circ$ . Compute the normal flow rate in gal/min.

**Solution:** For clay tile, take  $n \approx 0.014$ . For a half-full circle,

$$A = \frac{\pi}{2} R^2 = 1.57 \text{ m}^2, \quad R_h = \frac{R}{2} = 0.5 \text{ m},$$

$$Q = \frac{1}{0.014} (1.57)(0.5)^{2/3} \sqrt{\sin(0.25^\circ)} = 4.67 \text{ m}^3/\text{s} \approx \mathbf{74000 \text{ gal/min}} \quad \text{Ans.}$$

**10.33** Five of the sewer pipes from Prob. 10.32 empty into a single asphalt pipe, also laid out at  $0.25^\circ$ . If the large pipe is also to run half-full, what should be its diameter?

**Solution:** For asphalt, take  $n \approx 0.016$ . This time the radius is unknown:

$$Q = 5Q_{\text{small}} = 5(4.67) \frac{\text{m}^3}{\text{s}} = \frac{1}{0.016} \left( \frac{\pi}{2} R^2 \right) \left( \frac{R}{2} \right)^{2/3} \sqrt{\sin 0.25^\circ}, \quad \text{solve } R \approx 1.92 \text{ m}$$

or: **D  $\approx$  3.84 m** Ans.

**10.34** A brick rectangular channel, with a slope of 0.002, is designed to carry  $230 \text{ ft}^3/\text{s}$  of water in uniform flow. There is an argument over whether the channel width should be 4 ft or 8 ft. Which design needs fewer bricks? By what percentage?

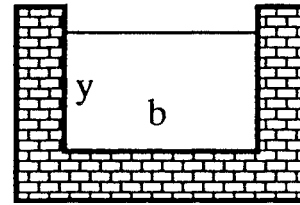


Fig. P10.34

**Solution:** For brick, take  $n \approx 0.015$ . For both designs,  $A = by$  and  $P = b + 2y$ . Thus

$$Q = 230 \frac{\text{ft}^3}{\text{s}} = \frac{1.486}{0.015} (by) \left( \frac{by}{b+2y} \right)^{2/3} (0.002)^{1/2}$$

(a) If  $b = 4$  ft, solve for  $y \approx 9.31$  ft or perimeter  $P \approx 22.62$  ft Ans. (a)

(b) If  $b = 8$  ft, solve  $y \approx 4.07$  ft or  $P \approx 16.14$  ft Ans. (b)

For a given channel-wall thickness, the number of bricks is proportional to the *perimeter*. Thus the 8-ft-wide channel has  $16.14/22.62 = 71\%$  as many, or **29% fewer bricks**.

**10.35** In flood stage a natural channel often consists of a deep main channel plus two floodplains, as in Fig. P10.35. The floodplains are often shallow and rough. If the channel has the same slope everywhere, how would you analyze this situation for the discharge? Suppose that  $y_1 = 20$  ft,  $y_2 = 5$  ft,  $b_1 = 40$  ft,  $b_2 = 100$  ft,  $n_1 = 0.020$ ,  $n_2 = 0.040$ , with a slope of 0.0002. Estimate the discharge in  $\text{ft}^3/\text{s}$ .

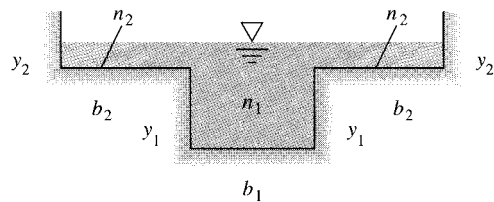


Fig. P10.35

**Solution:** We compute the flow rate in three pieces, with the dashed lines in the figure above serving as “water walls” which are not counted as part of the perimeter:

(a) Deep channel:  $Q_1 = \frac{1.486}{0.02} (25 \times 40) \left( \frac{25 \times 40}{20 + 40 + 20} \right)^{2/3} (0.0002)^{1/2} \approx 5659 \text{ ft}^3/\text{s}$

$$(b) \text{ Flood plains: } 2Q_2 = 2 \left( \frac{1.486}{0.04} \right) (5 \times 100) \left( \frac{5 \times 100}{5 + 100 + 0} \right)^{2/3} (0.0002)^{1/2} \approx 1487 \text{ ft}^3/\text{s}$$

$$\text{Total discharge } Q = Q_1 + 2Q_2 = 7150 \text{ ft}^3/\text{s} \quad \text{Ans.}$$

**10.36** The Blackstone River in northern Rhode Island normally flows at about  $25 \text{ m}^3/\text{s}$  and resembles Fig. P10.35 with a clean-earth center channel,  $b_1 \approx 20 \text{ m}$  and  $y_1 \approx 3 \text{ m}$ . The bed slope is about  $2 \text{ ft}/\text{mi}$ . The sides are heavy brush with  $b_2 \approx 150 \text{ m}$ . During hurricane Carol in 1955, a record flow rate of  $1000 \text{ m}^3/\text{s}$  was estimated. Use this information to estimate the maximum flood depth  $y_2$  during this event.

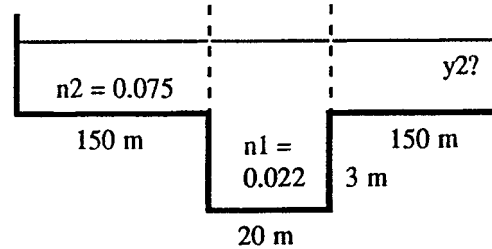


Fig. P10.36

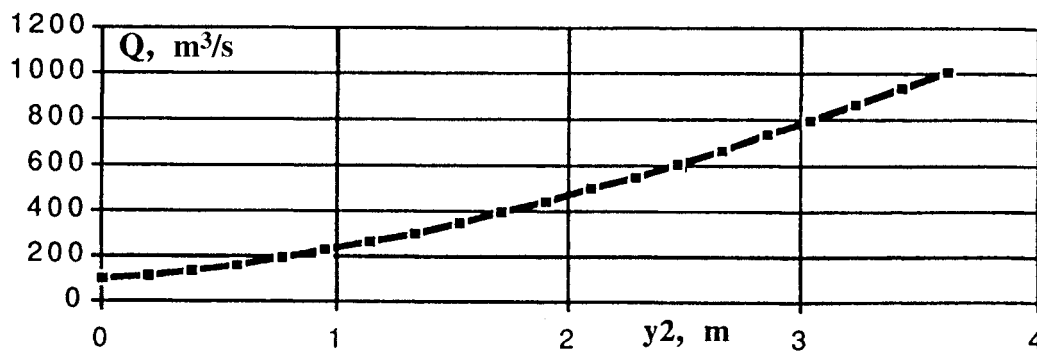
**Solution:** For heavy brush,  $n_2 = 0.075$  and for clean earth,  $n_1 = 0.022$ , as shown in the figure. Use the same “zero-perimeter water-wall” scheme as in Prob. 10.35:

$$Q = Q_1 + 2Q_2 = \frac{1}{0.022} A_1 R_{h1}^{2/3} S_o^{1/2} + 2 \frac{1}{0.075} A_2 R_{h2}^{2/3} S_o^{1/2} = \left( 1000 \frac{\text{m}^3}{\text{s}} \right)$$

$$\text{where } S_o = \frac{2}{5280}, \quad A_1 = (3 + y_2)20, \quad R_{h1} = \frac{A_1}{6 + 20}, \quad A_2 = 150y_2, \quad \text{and } R_{h2} = \frac{A_2}{y_2 + 150}$$

$$\text{Solve by iteration for } y_2 \approx 3.6 \text{ m.} \quad \text{Ans.}$$

This heavy rainfall overflowed the flood plains and was the worst in Rhode Island history. A graph of flow rate versus flood-plain depth  $y_2$  is shown below.



**10.37** A triangular channel (see Fig. E10.6) is to be constructed of corrugated metal and will carry  $8 \text{ m}^3/\text{s}$  on a slope of 0.005. The supply of sheet metal is limited, so the engineers want to minimize the channel surface. What is (a) the best included angle  $\theta$  for the channel; (b) the normal depth for part (a); and (c) the wetted perimeter for part (b).

**Solution:** For corrugated metal, take  $n = 0.022$ . From Ex. 10.5, for a vee-channel, recall that

$$A = y^2 \tan(\theta/2); \quad P = 2y \sec(\theta/2); \\ R_h = 0.5y \sin(\theta/2)$$

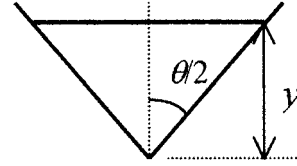


Fig. P10.37

Manning's formula (10.19) predicts that:

$$Q = \frac{1}{n} A R_h^{2/3} S_o^{1/2} = 8 \frac{\text{m}^3}{\text{s}} = \frac{1}{0.022} \left( y^2 \tan \frac{\theta}{2} \right) \left( \frac{y}{2} \sin \frac{\theta}{2} \right)^{2/3} \sqrt{0.005}$$

(a) Eliminate  $y$  in terms of  $P$  and set  $dP/d\theta = 0$ . The algebra is not too bad, and the result is:

$$\text{Minimum perimeter } P \text{ occurs for a given flow rate at } \theta = 90^\circ \quad \text{Ans. (a)}$$

(b) Insert  $\theta = 90^\circ$  in the formula for  $Q = 8 \text{ m}^3/\text{s}$  above and solve for:

$$y = 1.83 \text{ m} \quad \text{Ans. (b)} \quad \text{and} \quad P_{\min} = 5.16 \text{ m.} \quad \text{Ans. (c)}$$

**10.38** A rectangular channel has  $b = 3 \text{ m}$  and  $y = 1 \text{ m}$ . If  $n$  and  $S_o$  are the same, what is the diameter of a semicircular channel which will have the same discharge? Compare the two wetted perimeters.

**Solution:** The rectangular channel has  $A = 3 \text{ m}^2$  and  $P = 5 \text{ m}$ . Set the flow rates equal:

$$Q_{\text{rect}} = \frac{1}{n} (3 \text{ m}^2) \left( \frac{3}{5} \text{ m} \right)^{2/3} S_o^{1/2} \stackrel{?}{=} Q_{\text{semicircle}} = \frac{1}{n} \left( \frac{\pi}{2} R^2 \right) (R/2)^{2/3} S_o^{1/2},$$

$$\text{or: } R_{\text{circle}}^{8/3} = 2.16, \quad R \approx 1.334 \text{ m, or } D_{\text{semicircle}} \approx 2.67 \text{ m} \quad \text{Ans.}$$

The semicircle perimeter is  $P = \pi R \approx 4.19 \text{ m}$ , or **16% less** than the rectangle  $P = 5 \text{ m}$ .

**10.39** A trapezoidal channel has  $n = 0.022$  and  $S_o = 0.0003$  and is made in the shape of a half-hexagon for maximum efficiency. What should the length of the side of the hexagon be if the channel is to carry  $225 \text{ ft}^3/\text{s}$  of water? What is the discharge of a semicircular channel of the same cross-sectional area and the same  $S_o$  and  $n$ ?

**Solution:** The half-hexagon corresponds to Fig. 10.7 with  $\theta = 60^\circ$ . Its properties are

$$A = \frac{3b^2}{2} \sin 60^\circ, \quad R_h = \frac{b}{2} \sin 60^\circ,$$

$$Q = 225 \frac{\text{ft}^3}{\text{s}} = \frac{1.486}{0.022} \left( \frac{3}{2} b^2 \sin 60^\circ \right) \left( \frac{b}{2} \sin 60^\circ \right)^{2/3} (0.0003)^{1/2}$$

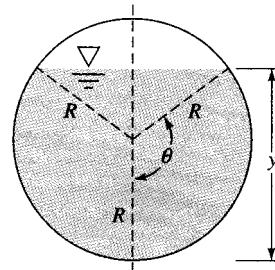
or:  $b^{8/3} \approx 259$ ,  $b \approx 8.03 \text{ ft}$  *Ans.* (for which  $A_{\text{hexagon}} \approx 83.79 \text{ ft}^2$ )

A semicircular channel of the same area has  $D = [8(83.79)/\pi]^{1/2} \approx 14.6 \text{ ft}$ . Its hydraulic radius and flow rate are

$$R_{h,\text{semicircle}} = D/4 \approx 3.65 \text{ ft}, \quad Q = \frac{1.486}{0.022} (83.8)(3.65)^{2/3} (0.0003)^{1/2}$$

$$Q \approx 232 \text{ ft}^3/\text{s} \text{ (about 3\% more flow) } \textit{Ans.}$$

**10.40** Using the geometry of Fig. 10.6a, prove that the most efficient circular open channel (maximum hydraulic radius for a given flow area) is a semicircle.



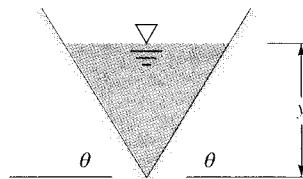
**Fig. 10.6 (a)**

**Solution:** Maximum hydraulic radius means minimum perimeter. Using Eq. 10.20,

$$A = R^2 \left( \theta - \frac{1}{2} \sin 2\theta \right), \quad P = 2R\theta, \text{ eliminate } R: \quad P = \frac{2\theta\sqrt{A}}{\sqrt{\theta - \sin(2\theta)/2}}$$

$$\text{Differentiate: } \left. \frac{dP}{d\theta} \right|_{\text{constant } A} = 0 \text{ if } \theta = 90^\circ \textit{ Ans.}$$

**10.41** Determine the most efficient value of  $\theta$  for the vee-shaped channel of Fig. P10.41.



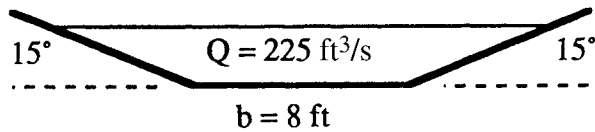
**Fig. P10.41**

**Solution:** Given the (simple) geometric properties

$$A = y^2 \cot \theta; \quad P = 2y \csc \theta; \quad \text{Eliminate } y: \quad P = 2 \csc \theta \sqrt{A \tan \theta}$$

$$\text{Set } \left. \frac{dP}{d\theta} \right|_{\text{constant } A} = 0 \quad \text{if } \theta = 45^\circ \quad \text{Ans.}$$

**10.42** Suppose that the side angles of the trapezoidal channel in Prob. 10.39 are reduced to  $15^\circ$  to avoid earth slides. If the bottom flat width is 8 ft, (a) determine the normal depth and (b) compare the resulting wetted perimeter with the solution  $P = 24.1$  ft from Prob. 10.39. (Do not reveal this answer to friends still struggling with Prob. 10.39.)



**Fig. P10.42**

**Solution:** Recall that we specified  $n \approx 0.022$  and  $S_o = 0.0003$ . The new bottom width,  $b = 8$  ft, is almost exactly what we found in Prob. 10.39 for the half-hexagon (8.03 ft).

$$\text{Set } Q = 225 \frac{\text{ft}^3}{\text{s}} = \frac{1.486}{0.022} A \left( \frac{A}{P} \right)^{2/3} (0.0003)^{1/2}, \quad \text{where } A = 8y + y^2 \cot(15^\circ)$$

$$\text{and } P = 8 + 2y \csc(15^\circ). \quad \text{Solve by iteration for } y_n \approx \mathbf{4.31 \text{ ft}} \quad \text{Ans. (a)}$$

$$\text{Wetted perimeter} = 8 + 2(4.31) \csc(15^\circ) \approx \mathbf{41.3 \text{ ft}} \quad \text{Ans. (b) (71\% more)}$$

**10.43** What are the most efficient dimensions for a riveted-steel *rectangular* channel to carry  $4.8 \text{ m}^3/\text{s}$  of water at a slope of 1:900?

**Solution:** For riveted steel, take  $n \approx 0.015$ . We know from Eq. (10.26) that

Best rectangle:  $b = 2y$ ;  $A = 2y^2$ ;  $R_h = y/2$ . So the flow rate is

$$Q = 4.8 = \frac{1}{0.015} (2y^2)(y/2)^{2/3} \left( \frac{1}{900} \right)^{1/2}, \quad \text{solve } y \approx \mathbf{1.22 \text{ m}}, \quad b \approx \mathbf{2.45 \text{ m}} \quad \text{Ans.}$$

**10.44** What are the most efficient dimensions for a *half-hexagon* cast-iron channel to carry 15000 gal/min of water at a slope of  $0.16^\circ$ ?

**Solution:** For cast iron, take  $n \approx 0.013$ . We know from Fig. 10.7 for a half-hexagon that

$$A = \frac{3b^2}{2} \sin 60^\circ, \quad R_h = \frac{b}{2} \sin 60^\circ, \quad \text{hence } Q = \frac{15000 \text{ ft}^3}{448.83 \text{ s}} = \frac{1.486}{0.013} A R_h^{2/3} \sqrt{\sin 0.16^\circ}$$

Solve for side length  $b \approx 2.12 \text{ ft}$  Ans.

**10.45** What are the most efficient dimensions for an asphalt *trapezoidal* channel to carry  $3 \text{ m}^3/\text{s}$  of water at a slope of 0.0008?

**Solution:** For asphalt, take  $n \approx 0.016$ . We know from Fig. 10.7 for a trapezoid that

$$A = y^2 [2 \csc 45^\circ - \cot 45^\circ]; \quad R_h = \frac{1}{2} y; \quad \text{Set } Q = 3 \frac{\text{m}^3}{\text{s}} = \frac{1}{0.016} A R_h^{2/3} \sqrt{0.0008}$$

or  $y^{8/3} \approx 1.47$ , or:  $y_n \approx 1.16 \text{ m}$  Ans. (corresponds to bottom width  $b = 0.96 \text{ m}$ )

**10.46** It is suggested that a channel which reduces erosion has a **parabolic shape**, as in Fig. P10.46. Formulas for area and perimeter of the parabolic cross-section are as follows [Ref. 7 of Chap. 10]:

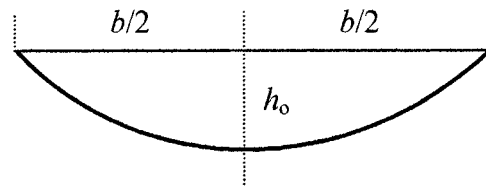


Fig. P10.46

$$A = \frac{2}{3} b h_0; \quad P = \frac{b}{2} \left[ \sqrt{1 + \alpha^2} + \frac{1}{\alpha} \ln \left( \alpha + \sqrt{1 + \alpha^2} \right) \right], \quad \text{where } \alpha = \frac{4h_0}{b}$$

For uniform flow conditions, determine the most efficient ratio  $h_0/b$  for this channel (minimum perimeter for a given constant area).

**Solution:** We are to minimize  $P$  for constant  $A$ , and this time, unlike Prob. 10.37, the algebra is too heavy, what with logarithms and square roots, to solve for  $P$  in terms of  $A$  and  $h_0/b$ . The writer backed off and simply used a spreadsheet (or EES) to find the minimum  $P$  numerically. The answer is

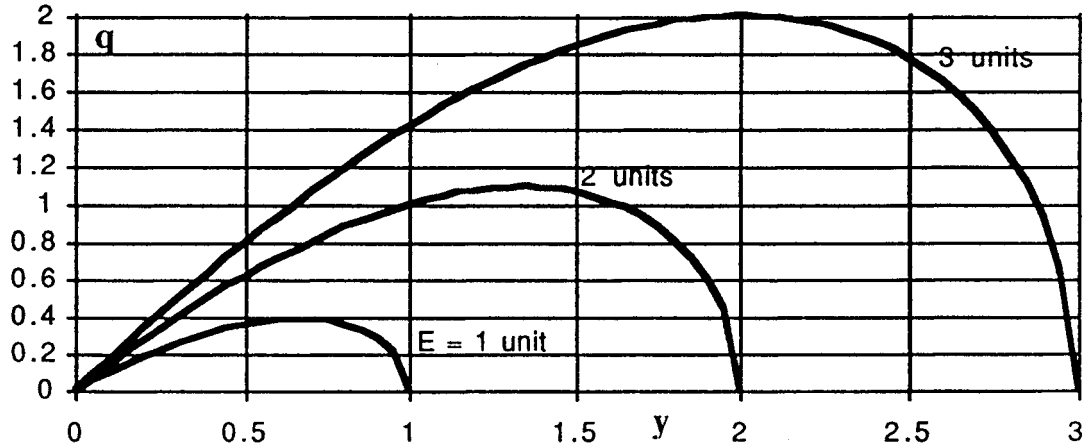
Minimum  $P$  (maximum  $Q$  for a given  $A$ ) occurs at  $h_0/b \approx 0.486$  Ans.

[NOTE: For a sine-wave shape, instead of a parabola, the answer is  $h_0/b \equiv 1/2$ .]



**10.47** Replot Fig. 10.8b in the form of  $q$  versus  $y$  for constant  $E$ . Does the maximum  $q$  occur at the critical depth?

**Solution:** The energy formula has the form  $q^2 = 2g(Ey^2 - y^3)$ , plot for constant  $E$  and  $g$ :



Differentiate to find  $dq/dy|_{\text{const } E} = 0$  if  $y = 2E/3$  **which indeed =  $y_{\text{crit}}$** . *Ans.*

**10.48** A wide, clean-earth river has a flow rate  $q = 150 \text{ ft}^3/(\text{s}\cdot\text{ft})$ . What is the critical depth? If the actual depth is 12 ft, what is the Froude number of the river? Compute the critical slope by (a) Manning's formula and (b) the Moody chart.

**Solution:** For clean earth, take  $n \approx 0.030$  and roughness  $\varepsilon \approx 0.8 \text{ ft}$ . The critical depth is

$$y_c = (q^2/g)^{1/3} = [(150)^2/32.2]^{1/3} \approx \mathbf{8.87 \text{ ft}} \quad \text{Ans.}$$

$$\text{If } y_{\text{actual}} = 12 \text{ ft, } Fr = \frac{V}{V_c} = \frac{q/y}{\sqrt{gy_c}} = \frac{150/12}{\sqrt{32.2(8.87)}} = \frac{12.5}{16.9} \approx \mathbf{0.739} \quad \text{Ans.}$$

The critical slope is easy to compute by Manning and somewhat harder by the Moody chart:

$$\text{(a) Manning: } S_c = \frac{gn^2}{\xi y_c^{1/3}} = \frac{32.2(0.030)^2}{2.208(8.87)^{1/3}} \approx \mathbf{0.00634 \text{ Manning}} \quad \text{Ans. (a)}$$

$$(b) \text{ Moody: } \frac{1}{\sqrt{f}} \approx -2 \log_{10} \left( \frac{0.8}{3.7(4)(8.87)} \right),$$

$$\text{or } f \approx 0.0509, \quad S_c = \frac{f}{8} \approx \mathbf{0.00637} \text{ Moody } \text{ Ans. (b)}$$

**10.49** Find the critical depth of the brick channel in Prob. 10.34 for both the 4- and 8-ft widths. Are the normal flows sub- or supercritical?

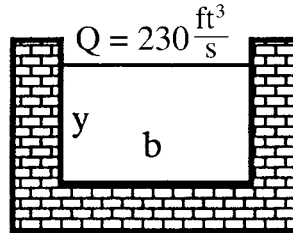


Fig. P10.49

**Solution:** For brick, take  $n \approx 0.015$ . Recall and extend our results from Prob. 10.34:

$$(a) \text{ } b = 4 \text{ ft: } y_c = \left( \frac{Q^2}{b^2 g} \right)^{1/3} = \left[ \frac{(230)^2}{(4)^2 (32.2)} \right]^{1/3} = \mathbf{4.68 \text{ ft}} \quad [y_n = 9.31 \text{ ft is subcritical}]$$

$$(b) \text{ } b = 8 \text{ ft: } y_c = \left[ \frac{(230)^2}{(8)^2 (32.2)} \right]^{1/3} = \mathbf{2.95 \text{ ft}} \quad [y_n = 4.07 \text{ ft is subcritical}] \text{ Ans. (a, b)}$$

**10.50** A pencil point piercing the surface of a rectangular channel flow creates a  $25^\circ$  half-angle wedgelike wave, as in Fig. P10.50. If the channel surface is painted steel and the depth is 35 cm, determine (a) the Froude no.; (b) the critical depth; and (c) the critical slope.

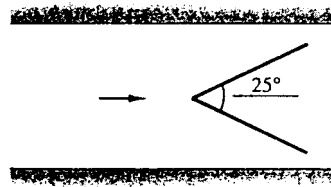


Fig. P10.50

**Solution:** For painted steel, take  $n \approx 0.014$ . The wave angle and depth give

$$Fr = \csc(25^\circ) = \mathbf{2.37} \text{ Ans. (a)} \quad \therefore V = Fr V_c = 2.37 \sqrt{9.81(0.35)} = 4.38 \frac{\text{m}}{\text{s}}$$

$$\text{Flow rate } q = Vy = 4.38(0.35) = 1.53 \frac{\text{ft}^3}{\text{s}\cdot\text{ft}}$$

$$y_c = \left( \frac{q^2}{g} \right)^{1/3} = \left[ \frac{(1.53)^2}{9.81} \right]^{1/3} \approx \mathbf{0.62 \text{ m}} \quad \text{Ans. (b)}$$

$$\text{Finally, } S_c = \frac{gn^2}{\xi y_c^{1/3}} = \frac{9.81(0.014)^2}{(1.0)(0.62)^{1/3}} = \mathbf{0.0023}$$

**10.51** An asphalt circular channel, of diameter 75 cm, is flowing half-full at an average velocity of 3.4 m/s. Estimate (a) the volume flow rate; (b) the Froude number; and (c) the critical slope.

**Solution:** For an asphalt channel, take  $n = 0.016$ . For a half-full channel,  $A = \pi R^2/2$ ,  $P = \pi R$ ,  $R_h = R/2$ , and  $b_o = 2R$ . The volume flow is easy, and Froude number and critical slope are not hard either:

$$Q = VA = \left( 3.4 \frac{\text{m}}{\text{s}} \right) [\pi(0.375 \text{ m})^2/2] = \mathbf{0.75 \text{ m}^3/\text{s}} \quad \text{Ans. (a)}$$

$$V_c = \sqrt{\frac{gA_c}{b_o}} = \sqrt{\frac{(9.81 \text{ m/s}^2)[\pi(0.375 \text{ m})^2/2]}{0.75 \text{ m}}} = 1.70 \frac{\text{m}}{\text{s}}, \quad \mathbf{Fr} = \frac{3.4 \text{ m/s}}{1.7 \text{ m/s}} = \mathbf{2.00} \quad \text{Ans. (b)}$$

$$S_c = \frac{n^2 V_c^2}{\alpha^2 R_{hc}^{4/3}} = \frac{(0.016)^2 (1.7 \text{ m/s})^2}{(1)^2 (0.1875 \text{ m})^{4/3}} = \mathbf{0.0069} \quad \text{Ans. (c)}$$

**10.52** Water flows full in an asphalt half-hexagon channel of bottom width  $W$ . The flow rate is  $12 \text{ m}^3/\text{s}$ . Estimate  $W$  if the Froude number is exactly 0.6.

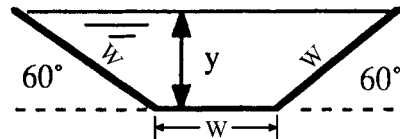


Fig. P10.52

**Solution:** For asphalt,  $n = 0.016$ , but we don't need  $n$  because *critical* flow is independent of roughness. Work out the properties of a half-hexagon:

$$y = W \sin 60^\circ, \quad A = Wy + y^2 \cot 60^\circ = 1.299W^2, \quad b_o = W + 2W \cos 60^\circ = 2W$$

$$V_c = \sqrt{\frac{gA}{b_o}} = \sqrt{\frac{9.81(1.299W^2)}{2W}} = 2.524W^{1/2}, \quad V = FrV_c = 0.6V_c = 1.515W^{1/2}$$

$$Q = 12 \frac{\text{m}^3}{\text{s}} = AV = (1.299W^2)(1.515W^{1/2}) = 1.967W^{2.5}, \quad \text{solve } \mathbf{W = 2.06 \text{ m}} \quad \text{Ans.}$$

**10.53** For the river flow of Prob. 10.48, find the depth  $y_2$  which has the same specific energy as the given depth  $y_1 = 12$  ft. These are called *conjugate depths*. What is  $Fr_2$ ?

**Solution:** Recall from Prob. 10.48 that the flow rate is  $q = 150 \text{ ft}^3/(\text{s}\cdot\text{ft})$ . Hence

$$E = y_1 + \frac{V_1^2}{2g} = 12 + \frac{(150/12)^2}{2(32.2)} = 14.43 \text{ ft} = y_2 + \frac{V_2^2}{2g} = y_2 + \frac{(150/y_2)^2}{2(32.2)}$$

This is a cubic equation which has only one realistic solution:  $y_2 \approx \mathbf{6.74 \text{ ft}}$  Ans.

$$V_2 = \frac{150}{6.74} = 22.2 \frac{\text{ft}}{\text{s}}, \quad Fr_2 = \frac{V_2}{V_{c2}} = \frac{22.2}{\sqrt{32.2(6.74)}} \approx \mathbf{1.51} \quad \text{Ans. (compared to } Fr_1 = 0.74)$$

**10.54** A clay tile V-shaped channel has an included angle of  $70^\circ$  and carries  $8.5 \text{ m}^3/\text{s}$ . Compute (a) the critical depth, (b) the critical velocity, and (c) the critical slope for uniform flow.

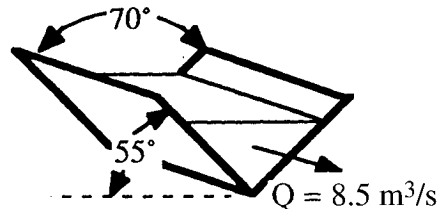


Fig. P10.54

**Solution:** For clay tile, take  $n \approx 0.014$ . The cross-section properties are

$$P = 2y \csc 55^\circ; \quad A = y^2 \cot 55^\circ; \quad R_h = \frac{y}{2} \cos 55^\circ; \quad b_o = 2y \cot 55^\circ$$

$$A_c = \left( \frac{b_o Q^2}{g} \right)^{1/3} = \left[ \frac{2y_c (\cot 55^\circ) (8.5)^2}{9.81} \right]^{1/3} = y_c^2 \cot 55^\circ, \quad \text{solve for } \mathbf{y_c \approx 1.975 \text{ m}} \quad \text{Ans. (a)}$$

$$\text{Compute } A_c = 2.731 \text{ m}^2, \quad b_{oc} = 2.766 \text{ m}, \quad V_c = \left[ \frac{9.81(2.731)}{2.766} \right]^{1/2} \approx \mathbf{3.11 \frac{m}{s}} \quad \text{Ans. (b)}$$

$$\text{Compute } R_h = 0.566 \text{ m}, \quad S_c = \frac{n^2 g A_c}{\alpha^2 b_o R_h^{4/3}} = \frac{(0.014)^2 (9.81) (2.731)}{(1) (2.766) (0.566)^{4/3}} \approx \mathbf{0.00405} \quad \text{Ans. (c)}$$

**10.55** A trapezoidal channel resembles Fig. 10.7 with  $b = 1$  m and  $\theta = 50^\circ$ . The water depth is 2 m and  $Q = 32$  m<sup>3</sup>/s. If you stick your fingernail in the surface, as in Fig. P10.50, what half-angle wave might appear?

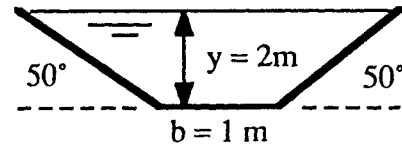


Fig. P10.55

**Solution:** The cross-section properties are

$$A = by + y^2 \cot 50^\circ = 5.36 \text{ m}^2, \quad \text{hence } V = Q/A = \frac{32}{5.36} \approx 5.97 \text{ m/s}$$

$$b_o = b + 2y \cot 50^\circ = 4.36 \text{ m}, \quad \text{hence } V_c = (gA/b_o)^{1/2} = \left[ \frac{9.81(5.36)}{4.36} \right]^{1/2} = 3.47 \text{ m/s}$$

$$\text{Thus } Fr = V/V_c = \frac{5.97}{3.47} = 1.72 = \csc \theta, \quad \text{or: } \theta_{\text{wave}} \approx 35.5^\circ \text{ Ans.}$$

The flow is definitely supercritical, and a ‘fingernail wave’ will indeed appear.

**10.56** A riveted-steel triangular duct flows partly full as in Fig. P10.56. If the critical depth is 50 cm, compute (a) the critical flow rate; and (b) the critical slope.

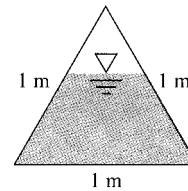


Fig. P10.56

**Solution:** For riveted steel, take  $n \approx 0.015$ . Then,

$$\text{If } y_c = 0.5 \text{ m, } b_o = 0.423 \text{ m, } A_c = 0.356 \text{ m}^2 = \left[ \frac{0.423Q^2}{9.81} \right]^{1/3},$$

$$\text{Solve } Q \approx 1.02 \frac{\text{m}^3}{\text{s}} \text{ Ans. (a)}$$

$$P = 2.15 \text{ m, } R_h = 0.165 \text{ m; } S_c = \frac{n^2 g A_c}{\alpha^2 b_o R_h^{4/3}} = \frac{(0.015)^2 (9.81)(0.356)}{(1)(0.423)(0.165)^{4/3}} \approx 0.0205 \text{ Ans. (b)}$$

**10.57** For the triangular duct of Fig. P10.56, if the critical flow rate is 1.0 m<sup>3</sup>/s, compute (a) the critical depth; and (b) the critical slope.

**Solution:** We were almost there in Prob. 10.56,  $Q \approx 1.02 \text{ m}^3/\text{s}$ —drop  $y$  a little bit, to 49 cm. This is too low,  $Q \approx 0.99 \text{ m}^3/\text{s}$ . So interpolate to  $y_c \approx \mathbf{0.493 \text{ m}}$ . *Ans.* (a).

$$\text{For } y = 0.493 \text{ m, } S_c = \frac{n^2 g A_c}{\alpha^2 b_o R_h^{4/3}} = \frac{(0.015)^2 (9.81)(0.350)}{(1)(0.446)(0.164)^{4/3}} \approx \mathbf{0.0194} \quad \textit{Ans. (b)}$$

**10.58** A circular corrugated-metal water channel is half-full and in uniform flow when laid on a slope of 0.0118. The average shear stress on the channel walls is 29 Pa. Estimate (a) the channel diameter; (b) the Froude number; and (c) the volume flow rate.

**Solution:** For corrugated metal take  $n = 0.022$ . This problem relates to Prob. 10.28, which showed that:

$$\tau_{avg} = \rho g R_h S_o = 29 \text{ Pa} = \left( 998 \frac{\text{kg}}{\text{m}^3} \right) \left( 9.81 \frac{\text{m}}{\text{s}^2} \right) R_h (0.0118), \quad \text{solve for } R_h = 0.251 \text{ m}$$

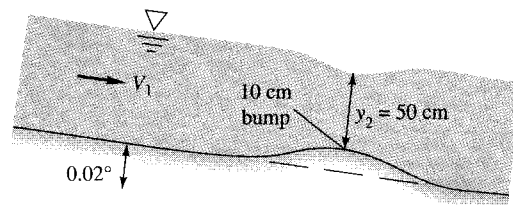
$$\text{Then } \mathbf{D_{channel}} = 4R_h = 4(0.251 \text{ m}) = \mathbf{1.00 \text{ m}} \quad \textit{Ans. (a)}$$

$$V = \frac{1}{n} R_h^{2/3} S_o^{1/2} = \frac{1}{0.022} (0.251 \text{ m})^{2/3} \sqrt{0.0118} = 1.96 \text{ m/s}$$

$$V_c = \sqrt{\frac{gA}{b_o}} = \sqrt{\frac{(9.81 \text{ m/s}^2)[\pi(0.5 \text{ m})^2/2]}{1.0 \text{ m}}} = 1.96 \text{ m/s}, \quad \mathbf{Fr} = \frac{1.96 \text{ m/s}}{1.96 \text{ m/s}} = \mathbf{1.00} \quad \textit{Ans. (b)}$$

$$Q = VA = (1.96 \text{ m/s})[\pi(0.5 \text{ m})^2/2] = \mathbf{0.77 \text{ m}^3/\text{s}} \quad \textit{Ans. (c)}$$

**10.59** Uniform water flow in a wide brick channel of slope  $0.02^\circ$  moves over a 10-cm bump as in Fig. P10.59. A slight depression in the water surface results. If the minimum depth over the bump is 50 cm, compute (a) the velocity over the bump; and (b) the flow rate per meter of width.



**Fig. P10.59**

**Solution:** For brickwork, take  $n \approx 0.015$ . Since the water level decreases over the bump, the upstream flow is *subcritical*. For a wide channel,  $R_h = y/2$ , and Eq. 10.39 holds:

$$y_2^3 - E_2 y_2^2 + \frac{q^2}{2g} = 0, \quad q = V_1 y_1, \quad E_2 = \frac{V_1^2}{2g} + y_1 - \Delta h, \quad \Delta h = 0.1 \text{ m}, \quad y_2 = 0.5 \text{ m}$$

Meanwhile, for uniform flow,  $q = \frac{1}{0.015} y_1 (y_1/2)^{2/3} \sqrt{\sin 0.02^\circ} = 0.785 y_1^{5/3}$

Solve these two simultaneously for  $y_1 = 0.608$  m,  $V_1 = \mathbf{0.563}$  m/s *Ans. (a)*, and  $q = \mathbf{0.342}$  m<sup>3</sup>/s·m. *Ans. (b)* [The upstream flow is subcritical,  $Fr_1 \approx 0.23$ .]

---

**10.60** Modify Prob. 10.59 as follows. Again assuming uniform subcritical approach conditions ( $V_1, y_1$ ), find (a) the flow rate and (b)  $y_2$  for which the Froude number  $Fr_2$  at the crest of the bump is exactly 0.7.

**Solution:** The basic analysis of Prob. 10.59 for uniform upstream flow plus a bump, still holds:

$$y_2^3 - E_2 y_2^2 + \frac{q^2}{2g} = 0; \quad q = V_1 y_1; \quad E_2 = \frac{V_1^2}{2g} + y_1 - \Delta h; \quad \Delta h = 0.1 \text{ m}$$

$$\text{Uniform upstream flow: } q = \frac{1}{0.015} y_1 \left( \frac{y_1}{2} \right)^{2/3} \sqrt{\sin(0.02^\circ)} = 0.785 y_1^{5/3}$$

This time, however,  $y_2$  is unknown, and we specify  $Fr_2 = V_2/(gy_2)^{1/2} = \mathbf{0.7}$ . Iteration or EES are necessary. The final results are that  $Fr_2 = 0.7$  if:

$$y_1 = 0.203 \text{ m}; \quad V_1 = 0.271 \text{ m/s}; \quad V_2 = 0.642 \text{ m/s}$$

$$q = \mathbf{0.055} \text{ m}^3/\text{s}/\text{m} \quad \textit{Ans. (a)}; \quad y_2 = \mathbf{0.0857} \text{ m} \quad \textit{Ans. (b)}$$


---

**10.61** Modify Prob. 10.59 as follows: Again assuming uniform subcritical approach flow  $V_1$ , find (a) the flow rate  $q$ ; and (b) the height  $y_2$  for which the Froude number  $Fr_2$  at the crest of the bump is exactly 1.0 (critical).

**Solution:** The basic analysis above, for uniform upstream flow plus a bump, still holds:

$$y_2^3 - E_2 y_2^2 + \frac{q^2}{2g} = 0, \quad q = V_1 y_1, \quad E_2 = \frac{V_1^2}{2g} + y_1 - \Delta h, \quad \Delta h = 0.1 \text{ m}$$

$$\text{Meanwhile, for uniform flow, } q = \frac{1}{0.015} y_1 (y_1/2)^{2/3} \sqrt{\sin 0.02^\circ} = 0.785 y_1^{5/3}$$

This time, however,  $y_2$  is unknown, and we need  $Fr_2 = V_2/\sqrt{gy_2} = \mathbf{1.0}$ . [At the crest in Prob. 10.60,  $Fr_2 \approx 0.8$ .] The iteration proceeds laboriously to the result:

$$Fr_2 = 1.0 \quad \text{if } y_1 = 0.1916 \text{ m}; \quad V_1 = 0.261 \frac{\text{m}}{\text{s}};$$

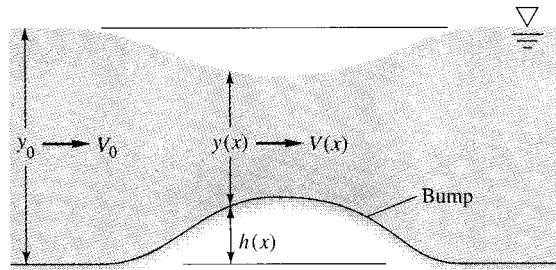
$$y_2 \approx \mathbf{0.0635 \text{ m}} \quad \text{Ans. (a);} \quad \mathbf{q = 0.0500 \frac{\text{m}^3}{\text{m} \cdot \text{s}}} \quad \text{Ans. (b)}$$

[Finding the *critical* point is more difficult than finding a purely subcritical solution.]

**10.62** Consider the flow in a wide channel over a bump, as in Fig. P10.62. One can estimate the water-depth change or *transition* with frictionless flow. Use continuity and the Bernoulli equation to show that

$$\frac{dy}{dx} = -\frac{dh/dx}{1 - V^2/(gy)}$$

Is the drawdown of the water surface realistic in Fig. P10.62? Explain under what conditions the surface might rise above its upstream position  $y_0$ .



**Fig. P10.62**

**Solution:** This is a form of frictionless “gradually-varied” flow theory (Sect. 10.6). Use the frictionless energy equation from upstream to any point along the bump section:

$$\frac{p_{\text{atm}}}{\rho g} + \frac{V_0^2}{2g} + y_0 = \frac{p_{\text{atm}}}{\rho g} + \frac{V^2}{2g} + h + y, \quad \text{differentiate: } 0 = \frac{VdV}{g} + dy + dh;$$

$$\text{Solve for: } \frac{dy}{dx} = -\frac{dh/dx}{1 - V^2/(gy)} \quad \text{Ans.}$$

Assuming  $dh/dx > 0$  in front (a ‘bump’),  $dy/dx$  will be positive (a *rise* in water level) if the flow is *supercritical* (i.e.,  $Fr > 1$  or  $V^2 > gy$ ).



**10.63** In Fig. P10.62, let  $V_0 = 1$  m/s and  $y_0 = 1$  m. If the maximum bump height is 15 cm, estimate (a) the Froude number over the top of the bump; and (b) the maximum depression in the water surface.

**Solution:** Here we don't need to differentiate, just apply Eq. 10.39 directly:

$$y_2^3 - E_2 y_2^2 + \frac{V_1^2 y_1^2}{2g} = 0, \quad \text{where } E_2 = \frac{V_1^2}{2g} + y_1 - h_{\max} = \frac{(1)^2}{2(9.81)} + 1 - 0.15 = 0.901 \text{ m}$$

$$\text{Insert } V_1 y_1 = 1.0 \text{ to get } y_2^3 - 0.901 y_2^2 + 0.051 = 0, \text{ solve for } y_2 \approx 0.826 \text{ m}$$

Thus the center depression is  $\Delta z = 1 - 0.15 - 0.826 \approx \mathbf{0.024 \text{ m}}$ . *Ans.* (b)  
Also,  $V_2 = 1.21$  m/s. The bump Froude number is  $Fr_2 = 1.21/[9.81(.826)]^{1/2} \approx \mathbf{0.425}$  *Ans.* (a).

---

**10.64** In Fig. P10.62, let  $V_0 = 1$  m/s and  $y_0 = 1$  m. If the flow over the top of the bump is *exactly critical* ( $Fr = 1$ ), determine the bump height  $h_{\max}$ .

**Solution:** Here we guess bump heights until we find  $Fr_2 = V_2/[gy_2]^{1/2} = 1.0$ . [Clearly the bump must be higher than 15 cm, which only gave  $\approx 0.425$  above.] After considerable iteration (first guess  $h_{\max}$ , then solve the resulting cubic for  $y_2$ ) we find

$$y_2^3 - E_2 y_2^2 + \frac{1}{2(9.81)} = 0, \quad E_2 = \frac{1}{2(9.81)} + 1 - h_{\max}, \quad Fr_2 = 1.0 \quad \text{if } \mathbf{h_{\max} \approx 0.35 \text{ m}} \quad \textit{Ans.}$$

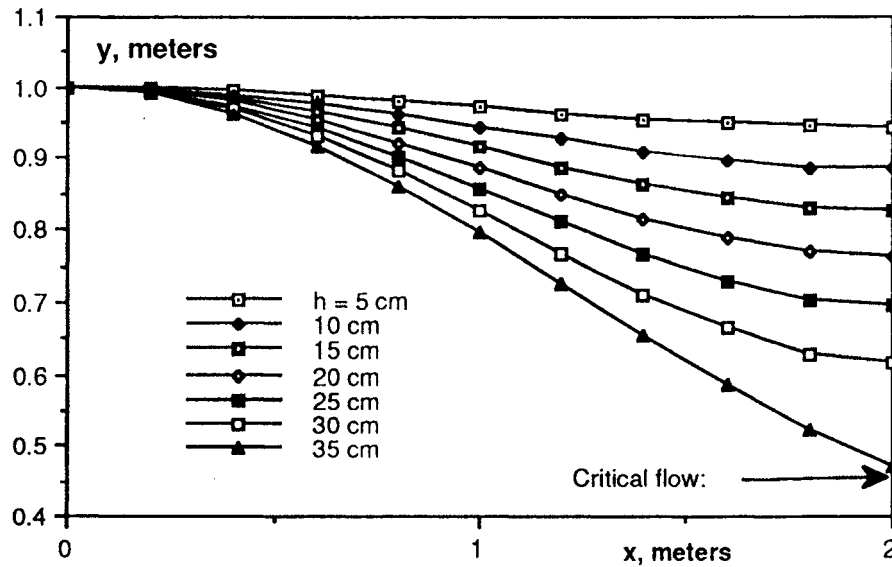
[This corresponds to a water level  $y_2 \approx 0.467$  m and  $\Delta z = 0.1873$  m.]

---

**10.65** Program and solve the differential equation of “frictionless flow over a bump,” from Prob. 10.62, for entrance conditions  $V_0 = 1$  m/s and  $y_0 = 1$  m. Let the bump have the convenient shape  $h = 0.5h_{\max}[1 - \cos(2\pi x/L)]$ , which simulates Fig. P10.62. Let  $L = 3$  m, and generate a numerical solution for  $y(x)$  in the bump region  $0 < x < L$ . If you have time for only one case, use  $h_{\max} = 15$  cm (Prob. 10.63), for which the maximum Froude number is 0.425. If more time is available, it is instructive to examine a complete family of surface profiles for  $h_{\max} \approx 1$  cm up to 35 cm (which is the solution of Prob. 10.64).

**Solution:** We solve the differential equation  $dy/dx = -(dh/dx)/[1 - V^2/(gy)]$ , with  $h = 0.5h_{\max}[1 - \cos(2\pi x/L)]$ , plus continuity,  $Vy = 1$  m<sup>2</sup>/s, subject to initial conditions  $V = 1.0$

and  $y = 1.0$  at  $x = 0$ . The plotted water profiles for various bump heights are as follows:



The Froude numbers at the point of maximum bump height are as follows:

$h_{\max}$ , cm:	0	5	10	15	20	25	30	35
$Fr_{\text{bump}}$ :	0.319	0.348	0.383	0.425	0.479	0.550	0.659	1.000

**10.66** In Fig. P10.62 let  $V_o = 6$  m/s and  $y_o = 1$  m. If the maximum bump height is 35 cm, estimate (a) the Froude number over the top of the bump; and (b) the maximum increase in the water-surface level.

**Solution:** This is a straightforward application of Eq. 10.39 for *supercritical* approach:

$$Fr_1 = \frac{V_1}{\sqrt{gy_1}} = \frac{6}{\sqrt{9.81(1)}} = 1.92 > 1. \quad E_2 = \frac{V_1^2}{2g} + y_1 - \Delta h = \frac{(6)^2}{2(9.81)} + 1 - 0.35 = 2.48 \text{ m}$$

$$y_2^3 - E_2 y_2^2 + \frac{V_1^2 y_1^2}{2g} = y_2^3 - 2.48 y_2^2 + 1.835 = 0; \quad \text{solve } y_2 \approx \mathbf{1.19 \text{ m}} \quad \text{Ans. (b)}$$

$$\text{Then } V_2 = 6(1)/1.19 = 5.03 \text{ m/s} \quad \text{and} \quad Fr_2 = V_2/\sqrt{(gy_2)} \approx \mathbf{1.47} \quad \text{Ans. (a)}$$

**10.67** In Fig. P10.62 let  $V_o = 5$  m/s and  $y_o = 1$  m. If the flow over the top of the bump is exactly critical ( $Fr = 1$ ), determine the bump height  $h_{\max}$ .

**Solution:** The set-up is the same as Prob. 10.66, with a different  $V_0$  and with  $Fr_2$  specified:

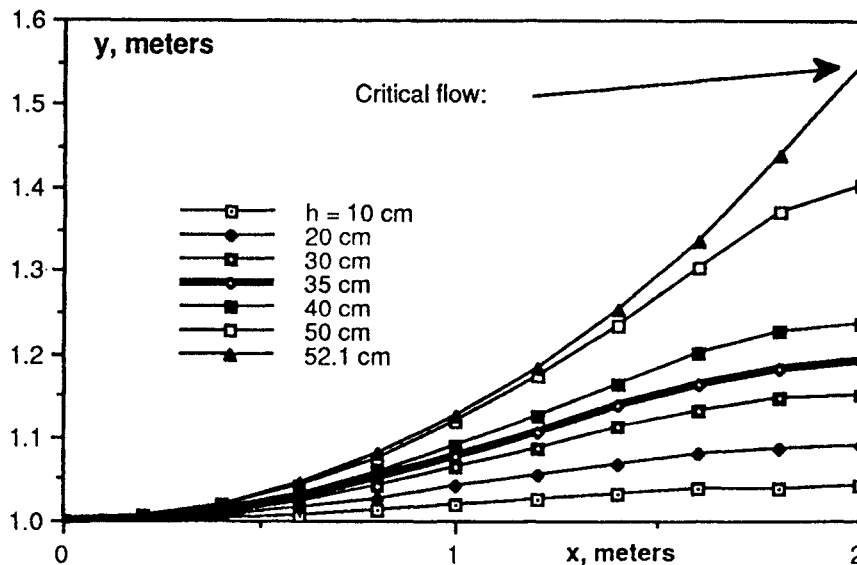
$$Fr_0 = \frac{5}{\sqrt{9.81(1.0)}} = 1.596; \quad E_2 = \frac{5^2}{2(9.81)} + 1.0 - h_{\max} = 2.274 - h_{\max}; \quad V_0 y_0 = V_2 y_2$$

$$\text{Solve } y_2^3 - E_2 y_2^2 + \frac{5^2}{2(9.81)} = 0 \quad \text{such that } Fr_2 = \frac{V_2}{\sqrt{9.81 y_2}} = 1.0$$

The solution is  $y_2 = 1.366$  m,  $V_2 = 3.66$  m/s, and  $h_{\max} = 0.225$  m. *Ans.*

**10.68** Modify Prob. 10.65 to have a supercritical approach condition  $V_0 = 6$  m/s and  $y_0 = 1$  m. If you have time for only one case, use  $h_{\max} = 35$  cm (Prob. 10.66), for which the maximum Froude number is 1.47. If more time is available, it is instructive to examine a complete family of surface profiles for  $1 \text{ cm} < h_{\max} < 52$  cm (which is the solution to Prob. 10.67).

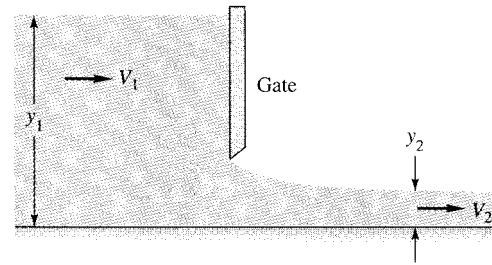
**Solution:** This is quite similar to the subcritical display in Prob. 10.65. The new family of supercritical-flow profiles is shown below:



The Froude numbers at the point of maximum bump height are as follows:

$h_{\max}$ , cm:	0	10	20	30	35	40	50	52.1
$Fr_{\text{bump}}$ :	1.92	1.80	1.68	1.55	1.47	1.39	1.15	1.000

**10.69** Given is the flow of a channel of large width  $b$  under a sluice gate, as in Fig. P10.69. Assuming frictionless steady flow with negligible upstream kinetic energy, derive a formula for the dimensionless flow rate  $Q^2/(y_1^3 b^2 g)$  as a function of the ratio  $y_2/y_1$ . Show by differentiation that the maximum flow rate occurs at  $y_2 = 2y_1/3$ .



**Fig. P10.69**

**Solution:** With upstream kinetic energy neglected, the energy equation becomes

$$y_1 \approx y_2 + \frac{V_2^2}{2g} = y_2 + \frac{(Q/by_2)^2}{2g}; \quad \text{rearrange and multiply by } (y_2^2/y_1^3):$$

$$\frac{Q^2}{gb^2 y_1^3} = 2(y_2/y_1)^2 - 2(y_2/y_1)^3 \quad \text{Ans.}$$

Differentiate this with respect to  $(y_2/y_1)$  to find maximum  $Q$  at  $y_2/y_1 = 2/3$  Ans.

**10.70** In Fig. P10.69 let  $V_1 = 0.75$  m/s and  $V_2 = 4.0$  m/s. Estimate (a) the flow rate per unit width; (b)  $y_2$ ; and (c)  $Fr_2$ .

**Solution:** Equation (10.40) is not too useful because  $y_1$  is unknown. Just use the basic equations:

$$E_1 = y_1 + \frac{V_1^2}{2g} = y_1 + \frac{(0.75 \text{ m/s})^2}{2(9.81 \text{ m/s}^2)} = E_2 = y_2 + \frac{V_2^2}{2g} = y_2 + \frac{(4.0 \text{ m/s})^2}{2(9.81 \text{ m/s}^2)}$$

$$q = V_1 y_1 = (0.75 \text{ m/s}) y_1 = V_2 y_2 = (4.0 \text{ m/s}) y_2$$

(a, b, c) Iterate, or use EES, and the final solution is:

$$q = \mathbf{0.726 \text{ m}^3/\text{s/m}} \quad \text{Ans. (a); } y_2 = \mathbf{0.182 \text{ m}} \quad \text{Ans. (b); } Fr_2 = V_2/(gy_2)^{1/2} = \mathbf{3.00} \quad \text{Ans. (c)}$$

**10.71** In Fig. P10.69 let  $y_1 = 95$  cm and  $y_2 = 50$  cm. Estimate the flow rate per unit width if the upstream kinetic energy is (a) neglected; and (b) included.

**Solution:** The result of Prob. 10.69 gives an excellent answer to part (a):

$$\text{Neglect } \frac{V_1^2}{2g}: \quad \frac{q^2}{2gy_1^3} = \left(\frac{y_2}{y_1}\right)^2 - \left(\frac{y_2}{y_1}\right)^3 = \left(\frac{50}{95}\right)^2 - \left(\frac{50}{95}\right)^3 = 0.1312 = \frac{q^2}{2(9.81)(0.95)^3}$$

$$\text{Solve for } \mathbf{q \approx 1.49 \frac{m^3}{s \cdot m}} \quad \text{Ans. (a)}$$

$$\text{(b) Exact: } y_2^3 - \left( \frac{V_1^2}{2g} + y_1 \right) y_2^2 + \frac{V_1^2 y_1^2}{2g} = 0,$$

$$\text{or: } V_1^2 = \frac{2gy_2^2(y_1 - y_2)}{y_1^2 - y_2^2} = \frac{2(9.81)(0.5)^2(0.95 - 0.5)}{(0.95)^2 - (0.5)^2} = 3.383,$$

$$V_1 = 1.84 \frac{m}{s}, \quad \mathbf{q = V_1 y_1 = 1.75 \frac{m^3}{s \cdot m}} \quad \text{Ans. (b)}$$

**10.72** Water approaches the wide sluice gate in the figure, at  $V_1 = 0.2$  m/s and  $y_1 = 1$  m. Accounting for upstream kinetic energy, estimate, at outlet section 2, (a) depth; (b) velocity; and (c) Froude number.

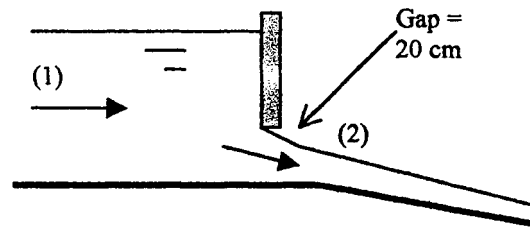


Fig. P10.72

**Solution:** (a) If we assume frictionless flow, the gap size is immaterial, and Eq. (10.40) applies:

$$y_2^3 - \left( y_1 + \frac{V_1^2}{2g} \right) y_2^2 + \frac{V_1^2 y_1^2}{2g} = 0 = y_2^3 - 1.00204 y_2^2 + 0.00204$$

EES yields 3 solutions:  $y_2 = 1.0$  m (trivial);  $-0.0442$  m (impossible);

and the correct solution:  $\mathbf{y_2 = 0.0462$  m *Ans. (a)*

$$\text{(b) From continuity, } V_2 = \frac{V_1 y_1}{y_2} = \frac{(1.0)(0.2)}{0.0462} = \mathbf{4.33 \frac{m}{s}} \quad \text{Ans. (b)}$$

$$\text{(c) The Froude number is } Fr_2 = \frac{V_2}{\sqrt{g y_2}} = \frac{4.33}{\sqrt{9.81(0.0462)}} = \mathbf{6.43} \quad \text{Ans. (c)}$$

**10.73** In Fig. P10.69 suppose that  $y_1 = 1.4$  m and the gate is raised so that its gap  $H$  is 15 cm. Estimate the resulting flow rate per unit width and the downstream depth.

**Solution:** The flow rate follows immediately from Eq. (10.41):

$$q = C_d H \sqrt{2gy_1}, \quad C_d = \frac{0.61}{\sqrt{1 + 0.61 H/y_1}} = \frac{0.61}{\sqrt{1 + 0.61(0.15 \text{ m})/(1.4 \text{ m})}} = 0.591$$

$$q = (0.591)(0.15 \text{ m})\sqrt{2(9.81 \text{ m/s}^2)(1.4 \text{ m})} = \mathbf{0.465 \text{ m}^3/\text{s/m}} \quad \text{Ans.}$$

With  $q$  known,  $V_1 = q/y_1 = 0.332 \text{ m/s}$  and  $E_1 = 1.406 \text{ m} = E_2$ .

$$\text{Solve for: } V_2 = 5.08 \text{ m/s} \quad \text{and} \quad y_2 = \mathbf{0.0915 \text{ m}} \quad \text{Ans. (Fr}_2 \approx 5.6)$$

**10.74** With respect to Fig. P10.69, show that, for frictionless flow, the upstream velocity may be related to the water levels by

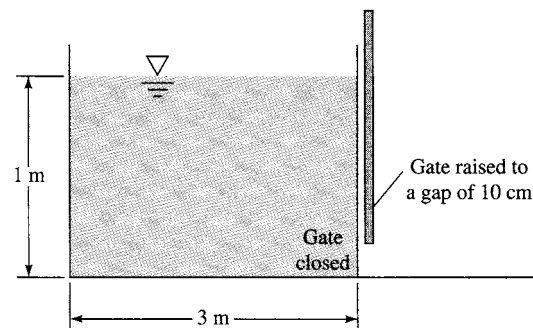
$$V_1 = \sqrt{\frac{2g(y_1 - y_2)}{K^2 - 1}} \quad \text{where } K = y_1/y_2.$$

**Solution:** We have already shown this beautifully in Prob. 10.71*b*:

$$\text{Eq. 10.40: } y_2^3 - (y_1 + V_1^2/2g)y_2^2 + (V_1 y_1)^2/2g = 0;$$

$$\text{Solve for } V_1 = \sqrt{\frac{2gy_2^2(y_1 - y_2)}{y_1^2 - y_2^2}} \quad \text{Ans.}$$

**10.75** A tank of water 1 m deep, 3 m long, and 4 m wide into the paper has a closed sluice gate on the right side, as in Fig. P10.75. At  $t = 0$  the gate is opened to a gap of 10 cm. Assuming quasi-steady sluice-gate theory, estimate the time required for the water level to drop to 50 cm. Assume free outflow.



**Fig. P10.75**

**Solution:** Use a control volume surrounding the tank with Eq. 10.41 for the gate flow:

$$\frac{d}{dt}(\text{tank water}) = \frac{d}{dt}(bLy_1) = -Q_{\text{out}} = -C_d H b \sqrt{2gy_1}, \quad C_d \approx 0.61/\sqrt{1 + 0.61H/y_1}$$

Because  $y_1$  drops from 1.0 to 0.5 m,  $C_d$  also drops slowly from 0.592 to 0.576. Assume approximately constant  $C_d \approx \mathbf{0.584}$ , separate the variables and integrate:

$$\int_{y_o}^{y_1} \frac{dy_1}{\sqrt{y_1}} = -\frac{H}{L} C_d \sqrt{2g} \int_0^t dt, \quad \text{or: } y_1 \approx (y_o^{1/2} - Kt)^2, \quad y_o = 1 \text{ m} \quad \text{and} \quad K = \frac{C_d H \sqrt{2g}}{2L}$$

$$K = \frac{0.584(0.1)\sqrt{2(9.81)}}{2(3.0)} = 0.0431. \quad \text{Set } y_1 = 0.5 \text{ m, solve for } t \approx \mathbf{6.8 \text{ s}} \quad \text{Ans.}$$

**10.76** In Prob. 10.75 estimate what gap height  $H$  would cause the tank level to drop from 1 m to 30 cm in exactly 40 s. Assume free outflow.

**Solution:** We have the analytic solution to draining in Prob. 10.75. Just find  $H$ :

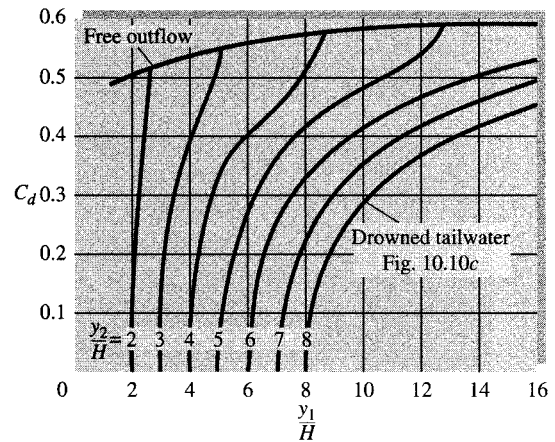
$$y_{1,final} = (y_o^{1/2} - Kt)^2 = 0.3 \text{ m} = \left[ (1.0 \text{ m})^{1/2} - \frac{C_d H \sqrt{2(9.81 \text{ m/s}^2)}}{2(3.0 \text{ m})} (40 \text{ s}) \right]^2,$$

$$C_d = \frac{0.61}{\sqrt{1 + 0.61H/(1 \text{ m})}}$$

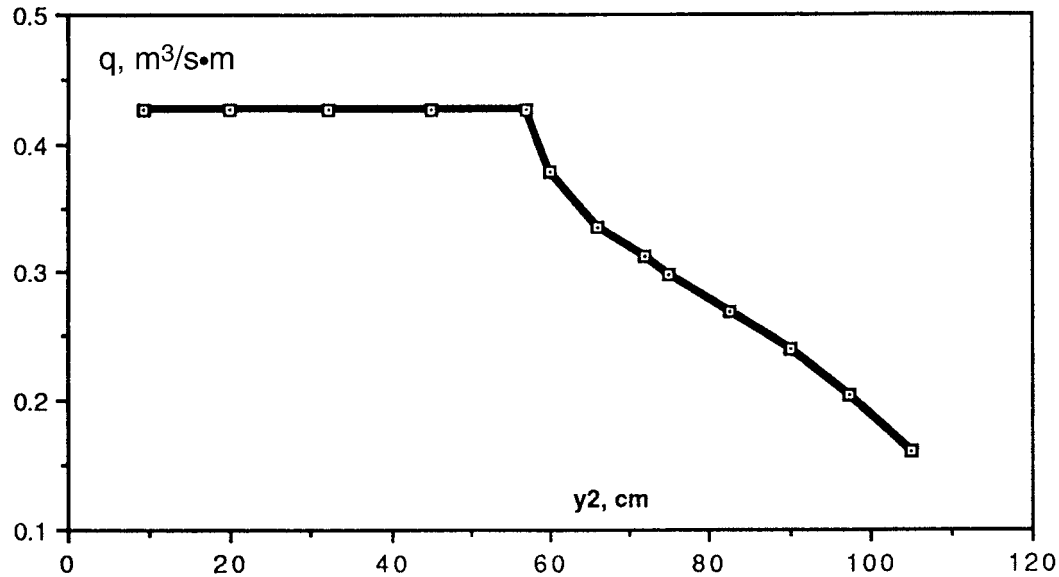
We approximated  $y_1 \approx 1 \text{ m}$  in the  $C_d$  formula, but the variation in  $C_d \approx 0.6$  is negligible. A bit of iteration gives the final solution:  $C_d \approx 0.605$ ,  $H = \mathbf{0.0253 \text{ m}}$ . Ans.

**10.77** Equation 10.41 for the discharge coefficient is for *free* (nearly frictionless) outflow. If the outlet is *drowned*, as in Fig. 10.10c, there is dissipation and  $C_d$  drops sharply. Fig. P10.77 at right shows data from Ref. 3 on drowned vertical sluice gates. Use this chart to repeat Prob. 10.73, and plot the estimated flow rate versus  $y_2$  in the range  $0 < y_2 < 60 \text{ cm}$ .

**Solution:** Actually, for  $y_1/H = 1.2/0.15 = 8$ , there is no effect of drowning until  $y_2/H > 3.8$ , or  $y_2 \approx 3.8(15) \approx 57 \text{ cm}$ . So let us plot out the flow rate a little further, up to  $y_2 \approx 105 \text{ cm}$ , as shown on the next page. The effect of drowning is very sudden and sharp according to this correlation.



**Fig. P10.77** [from Ref. 2 of Chap. 10]



**10.78** Repeat Prob. 10.75, to find the time to drain the tank from 1.0 m to 50 cm, if the gate is *drowned* downstream at  $y_2 = 40$  cm. Again assume gap  $H = 10$  cm.

**Solution:** With drowning, the discharge coefficient changes substantially during the drawdown, so our simple Prob. 10.75 solution,  $y_1 \approx (1-Kt)^2$ , is not valid. So we use the chart, Fig. P10.77, and calculate  $C_d$  and the flow rate as a function of tank depth:

$y_1$ , m:	1.0	0.9	0.8	0.7	0.6	0.5
$C_d$ :	0.58	0.58	0.52	0.45	0.40	0.33
$q$ , m <sup>3</sup> /s·m:	0.257	0.244	0.206	0.167	0.137	0.103

Then we sum the approximate times to drop each 10 cm, as  $\sum \Delta t = \sum (0.3 \text{ m}^3)/q_{\text{avg}}$ . The approximate result is  $t = \sum \Delta t \approx \mathbf{8.6 \text{ s}}$ , or 27% more than in Prob. 10.75. *Ans.*

**10.79** Show that the Froude number downstream of a hydraulic jump will be given by  $Fr_2 = 8^{1/2} Fr_1 / [(1 + 8Fr_1^2)^{1/2} - 1]^{3/2}$ . Does the formula remain correct if we reverse subscripts 1 and 2? Why?



**Solution:** Take the ratio of Froude numbers, use continuity, and eliminate  $y_2/y_1$ :

$$\frac{Fr_2}{Fr_1} = \frac{V_1}{\sqrt{gy_1}} \frac{\sqrt{gy_2}}{V_2} = \frac{V_1}{V_2} \sqrt{\frac{y_2}{y_1}}, \quad \text{but } \frac{V_1}{V_2} = \frac{y_2}{y_1} \text{ from continuity, so } \frac{Fr_2}{Fr_1} = \left(\frac{y_2}{y_1}\right)^{3/2}$$

$$\text{From Eq. 10.43, } \frac{y_2}{y_1} = \frac{1}{2} \left[ \sqrt{1 + 8Fr_1^2} - 1 \right],$$

$$\text{so rearrange to } Fr_2 = \frac{Fr_1 \sqrt{8}}{\left[ \sqrt{1 + 8Fr_1^2} - 1 \right]^{3/2}} \quad \text{Ans.}$$

The formula is indeed *symmetric*, you can reverse “1” and “2.” *Ans.*

**10.80** Water, flowing in a channel at 30-cm depth, undergoes a hydraulic jump of dissipation 71%. Estimate (a) the downstream depth; and (b) the volume flow.

**Solution:** We use the jump and dissipation relations, Eqs. (10.43) and (10.45):

$$\frac{2y_2}{y_1} = -1 + \sqrt{1 + 8Fr_1^2}, \quad Fr_1^2 = \frac{V_1^2}{gy_1}, \quad h_f = \frac{(y_2 - y_1)^3}{4y_1 y_2} = 0.71 \left( y_1 + \frac{V_1^2}{2g} \right), \quad y_1 = 0.3 \text{ m}$$

$$\text{Solve by EES: } V_1 = 16.1 \text{ m/s; } Fr_1 = 9.38; \quad y_2 = \mathbf{3.83 \text{ m}} \quad \text{Ans. (a);}$$

$$q = \mathbf{4.83 \text{ m}^3/\text{s}\cdot\text{m}} \quad \text{Ans. (b)}$$

**10.81** Water flows in a wide channel at  $q = 25 \text{ ft}^3/\text{s}\cdot\text{ft}$  and  $y_1 = 1 \text{ ft}$  and undergoes a hydraulic jump. Compute  $y_2$ ,  $V_2$ ,  $Fr_2$ ,  $h_f$ , the percentage dissipation, and the horsepower dissipated per unit width. What is the critical depth?

**Solution:** This is a series of straightforward calculations:

$$V_1 = \frac{q}{y_1} = \frac{25}{1} = 25 \frac{\text{ft}}{\text{s}}; \quad Fr_1 = \frac{V_1}{\sqrt{gy_1}} = \frac{25}{\sqrt{32.2(1)}} = 4.41; \quad E_1 = y_1 + \frac{V_1^2}{2g} \approx 10.7 \text{ ft}$$

$$\frac{y_2}{y_1} = \frac{1}{2} \left[ \sqrt{1 + 8(4.41)^2} - 1 \right] = 5.75, \quad \text{or } y_2 \approx \mathbf{5.75 \text{ ft}} \quad \text{Ans. (a)}$$

$$V_2 = q/y_2 = 25/5.75 \approx \mathbf{4.35 \frac{ft}{s}}; \quad Fr_2 = \frac{4.35}{\sqrt{32.2(5.75)}} \approx \mathbf{0.32} \quad \text{Ans. (b, c)}$$

$$h_f = (5.75 - 1)^3 / [4(5.75)(1)] \approx 4.66 \text{ ft}, \quad \% \text{ dissipated} = 4.66/10.7 \approx \mathbf{44\%} \quad \text{Ans. (d)}$$

$$\text{Power dissipated} = \rho g q h_f = (62.4)(25)(4.66) \div 550 \approx \mathbf{13.2 \text{ hp/ft}} \quad \text{Ans. (e)}$$

$$\text{Critical depth } y_c = (q^2/g)^{1/3} = [(25)^2/32.2]^{1/3} \approx \mathbf{2.69 \text{ ft}} \quad \text{Ans. (f)}$$

**10.82** Downstream of a wide hydraulic jump the flow is 4 ft deep and has a Froude number of 0.5. Estimate (a)  $y_1$ ; (b)  $V_1$ ; (c)  $Fr_1$ ; (d) the percent dissipation; and (e)  $y_c$ .

**Solution:** As shown in Prob. 10.79, the hydraulic jump formulas are reversible. Thus, with  $Fr_1$  known,

$$Fr_1 = \frac{Fr_2 \sqrt{8}}{\left[ \sqrt{1 + 8Fr_2^2} - 1 \right]^{3/2}} = \frac{(0.5)\sqrt{8}}{\left[ \sqrt{1 + 8(0.5)^2} - 1 \right]^{3/2}} = \mathbf{2.26} \quad \text{Ans. (c)}$$

$$2 \frac{y_1}{y_2} = 2 \left( \frac{y_1}{4 \text{ ft}} \right) = -1 + \sqrt{1 + 8(0.5)^2} = 0.732, \quad \mathbf{y_1 = 1.46 \text{ ft}} \quad \text{Ans. (a)}$$

$$V_1 = Fr_1 \sqrt{g y_1} = 2.26 \sqrt{(32.2 \text{ ft/s}^2)(1.46 \text{ ft})} = \mathbf{15.5 \text{ ft/s}} \quad \text{Ans. (b)}$$

The percent dissipation follows from Eq. (10.45):

$$h_f = \frac{(y_2 - y_1)^3}{4y_1y_2} = \frac{(4.0 \text{ ft} - 1.46 \text{ ft})^3}{4(4.0 \text{ ft})(1.46 \text{ ft})} = 0.696 \text{ ft}; \quad E_1 = y_1 + \frac{V_1^2}{2g} = 1.46 \text{ ft} + \frac{(15.5)^2}{2(32.2)} = 5.20 \text{ ft}$$

$$\text{Percent dissipation} = \frac{h_f}{E_1} = \frac{0.696 \text{ ft}}{5.20 \text{ ft}} = 0.13 \quad \text{or} \quad \mathbf{13\%} \quad \text{Ans. (d)}$$

Finally, the critical depth for a wide channel is given by Eq. (10.30):

$$q = V_1 y_1 = (15.5 \text{ ft/s})(1.46 \text{ ft}) = 22.7 \text{ m}^2/\text{s}; \quad y_c = \left( \frac{q^2}{g} \right)^{1/3} = \left[ \frac{(22.7)^2}{32.2} \right]^{1/3} = \mathbf{2.52 \text{ ft}} \quad \text{Ans. (e)}$$

**10.83** A wide channel flow undergoes a hydraulic jump from 40 cm to 140 cm. Estimate (a)  $V_1$ ; (b)  $V_2$ ; (c) the critical depth; and (d) the percent dissipation.

**Solution:** With the jump-height-ratio known, use Eq. 10.43:

$$\frac{2y_2}{y_1} = \frac{2(140)}{40} = 7 = \sqrt{1 + 8Fr_1^2} - 1, \quad \text{solve for } Fr_1 \approx 2.81$$

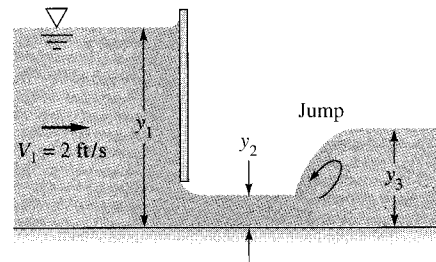
$$V_1 = Fr_1 \sqrt{gy_1} = 2.81 \sqrt{9.81(0.4)} \approx 5.56 \frac{\text{m}}{\text{s}} \quad \text{Ans. (a);} \quad V_2 = \frac{V_1 y_1}{y_2} \approx 1.59 \frac{\text{m}}{\text{s}} \quad \text{Ans. (b)}$$

$$q = V_1 y_1 = 5.56(0.4) = 2.22 \frac{\text{m}^3}{\text{s} \cdot \text{m}}, \quad y_{\text{crit}} = \left( \frac{q^2}{g} \right)^{1/3} = \left[ \frac{(2.22)^2}{9.81} \right]^{1/3} \approx 0.80 \text{ m} \quad \text{Ans. (c)}$$

$$E_1 = y_1 + \frac{V_1^2}{2g} = 0.4 + \frac{(5.56)^2}{2(9.81)} = 1.98 \text{ m}; \quad h_f = \frac{(y_2 - y_1)^3}{4y_1 y_2} = \frac{(1.4 - 0.4)^3}{4(0.4)(1.4)} = 0.45 \text{ m}$$

$$\% \text{ dissipation} = h_f/E_1 = 0.45/1.98 \approx 23\% \quad \text{Ans. (d)}$$

**10.84** Consider the flow under the sluice gate of Fig. P10.84. If  $y_1 = 10$  ft and all losses are neglected except the dissipation in the jump, calculate  $y_2$  and  $y_3$  and the percentage of dissipation, and sketch the flow to scale with the EGL included. The channel is horizontal and wide.



**Fig. P10.84**

**Solution:** First get the conditions at “2” by assuming a frictionless acceleration:

$$E_1 = y_1 + \frac{V_1^2}{2g} = 10 + \frac{(2)^2}{2(32.2)} = 10.062 \text{ ft} = E_2 = y_2 + \frac{V_2^2}{2g}, \quad \text{Also, } V_1 y_1 = V_2 y_2 = 20$$

$$\text{Solve for } V_2 \approx 24.4 \text{ ft/s; } y_2 \approx 0.820 \text{ ft} \quad \text{Ans. (a)} \quad Fr_2 = \frac{24.4}{\sqrt{32.2(0.820)}} \approx 4.75$$

$$\text{Jump: } \frac{y_3}{y_2} = \frac{1}{2} \left[ \sqrt{1 + 8Fr_2^2} - 1 \right] \approx 6.23, \quad y_3 \approx 5.11 \text{ ft} \quad \text{Ans. (b)}$$

$$E_2 = 10.062 \text{ ft; } h_f = \frac{(y_3 - y_2)^3}{4y_2 y_3} = \frac{(5.11 - 0.82)^3}{4(0.82)(5.11)} \approx 4.71 \text{ ft,}$$

$$\text{Dissipation} = \frac{4.71}{10.06} \approx 47\% \quad \text{Ans. (c)}$$

**10.85** In Prob. 10.72 the exit velocity from the sluice gate is 4.33 m/s. If there is a hydraulic jump at “3” just downstream of section 2, determine the downstream (a) velocity; (b) depth; (c) Froude number; and (d) percent dissipation.

**Solution:** If  $V_2 = 4.33$  m/s, then  $y_2 = V_1 y_1 / V_2 = (1.0)(0.2) / 4.33 = 0.0462$  m, and the Froude number is  $Fr_2 = V_2 / [gy_2]^{1/2} = 6.43$ . Now use hydraulic jump theory:

$$\frac{2y_3}{y_2} = -1 + \sqrt{1 + 8(6.43)^2} = 17.2, \quad \text{or: } y_3 = \mathbf{0.398 \text{ m}} \quad \text{Ans. (b)}$$

$$V_3 = \frac{q}{y_3} = \frac{(1.0)(0.2)}{0.398} = \mathbf{0.503 \frac{\text{m}}{\text{s}}} \quad \text{Ans. (a)}$$

$$Fr_3 = \frac{V_3}{\sqrt{gy_3}} = \frac{0.503}{\sqrt{9.81(0.398)}} = \mathbf{0.255} \quad \text{Ans. (c)}$$

$$h_f = \frac{(0.398 - 0.046)^3}{4(0.398)(0.046)} = 0.592 \text{ m}; \quad \frac{h_f}{E_2} = \frac{0.592}{0.046 + (4.33)^2 / 2g} = 0.59 \quad \text{or } \mathbf{59\%} \quad \text{Ans. (d)}$$

**10.86** A bore is a hydraulic jump which propagates upstream into a still or slower-moving fluid, as in Fig. 10.4a. Suppose that the still water is 2 m deep and the water behind the bore is 3 m deep. Estimate (a) the propagation speed of the bore and (b) the induced water velocity.

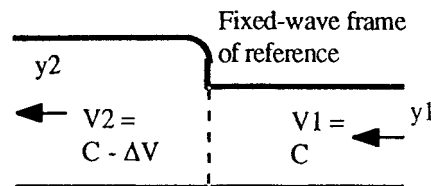


Fig. P10.86

**Solution:** The bore moves at speed  $C$  and induces a velocity  $\Delta V$  behind it. If viewed in a frame fixed to the wave, as above, the approach velocity is  $V_1 = C$  and, downstream,  $V_2 = C - \Delta V$ , as shown. We are given  $y_1 = 2$  m and  $y_2 = 3$  m so we can use Eq. 10.43:

$$\frac{y_2}{y_1} = \frac{3}{2} = \frac{1}{2} \left[ \sqrt{1 + 8Fr_1^2} - 1 \right], \quad \text{solve for } Fr_1 = 1.37$$

$$\text{Then } V_1 = C = Fr_1 \sqrt{gy_1} = 1.37 \sqrt{9.81(2)} \approx \mathbf{6.07 \frac{\text{m}}{\text{s}}} \quad \text{Ans. (a)}$$

$$\text{Meanwhile, } V_2 = \frac{V_1 y_1}{y_2} = \frac{6.07(2)}{3} = 4.04 = 6.07 - \Delta V, \quad \text{hence } \Delta V \approx \mathbf{2.03 \frac{\text{m}}{\text{s}}} \quad \text{Ans. (b)}$$

**10.87** A tidal bore may occur when the ocean tide enters an estuary against an oncoming river discharge, such as on the Severn River in England. Suppose that the tidal bore is 10 ft deep and propagates at 13 mi/h upstream into a river which is 7 ft deep. Estimate the river current in kn.

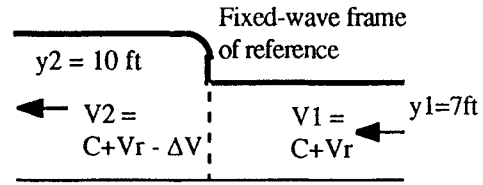


Fig. P10.87

**Solution:** Modify the analysis in 10.86 by superimposing a river velocity  $V_r$  onto the flow. Then, as shown, the approach velocity is  $V_1 = C + V_r$ , where  $C = 13 \text{ mi/h} = 19.06 \text{ ft/s}$ . We may again use Eq. 10.43 to find the Froude number:

$$\frac{y_2}{y_1} = \frac{10}{7} = \frac{1}{2} \left[ \sqrt{1 + 8Fr_1^2} - 1 \right], \quad \text{solve for } Fr_1 = 1.32$$

$$\text{Then } V_1 = C + V_r = Fr_1 \sqrt{gy_1} = 1.32 \sqrt{32.2(7)} = 19.77 \text{ ft/s} = 19.06 + V_r$$

$$\text{Thus } V_r = 0.71 \text{ ft/s} \approx \mathbf{0.42 \text{ knots}} \quad \text{Ans.}$$

**10.88** For the situation in Fig. P10.84, suppose that at section 3 the depth is 2 m and the Froude number is 0.25. Estimate (a) the flow rate per meter of width; (b)  $y_c$ ; (c)  $y_1$ ; (d) the percent dissipation in the jump; and (e) the gap height  $H$  of the gate.

**Solution:** We have enough information to immediately calculate the flow rate:

$$Fr_3 = 0.25 = \frac{V_3}{\sqrt{gy_3}} = \frac{V_3}{\sqrt{(9.81 \text{ m/s}^2)(2 \text{ m})}},$$

$$\text{Solve } V_3 = 1.11 \frac{\text{m}}{\text{s}}, \quad q = V_3 y_3 = \mathbf{2.22 \frac{\text{m}^3}{\text{s} \cdot \text{m}}} \quad \text{Ans. (a)}$$

The critical velocity is  $y_c = (q^2/g)^{1/3} = [(2.22 \text{ m}^2/\text{s})^2/(9.81 \text{ m/s}^2)]^{1/3} = \mathbf{0.794 \text{ m}}$ . Ans. (b)

We have to work our way back through the jump and sluice gate to find  $y_1$ :

$$\frac{2y_2}{y_3} = -1 + \sqrt{1 + 8Fr_3^2} = \frac{2y_2}{(2 \text{ m})} = -1 + \sqrt{1 + 8(0.25)^2}, \quad \text{solve } y_2 = 0.225 \text{ m}$$

$$V_2 = q/y_2 = (2.22)/(0.225) = 9.86 \text{ m/s}, \quad E_2 = y_2 + \frac{V_2^2}{2g} = 0.225 + \frac{(9.86)^2}{2(9.81)} = 5.18 \text{ m}$$

$$E_2 = E_1 = 5.18 \text{ m} = y_1 + \frac{V_1^2}{2g}, \quad q = V_1 y_1 = 2.22 \frac{\text{m}^3}{\text{s} \cdot \text{m}}, \quad \text{solve } \mathbf{y_1 = 5.17 \text{ m}} \quad \text{Ans. (c)}$$

The head loss in the jump leads to percent dissipation:

$$h_f = \frac{(y_3 - y_2)^3}{4y_3y_2} = \frac{(2 \text{ m} - 0.225 \text{ m})^3}{4(2 \text{ m})(0.225 \text{ m})} = 3.11 \text{ m},$$

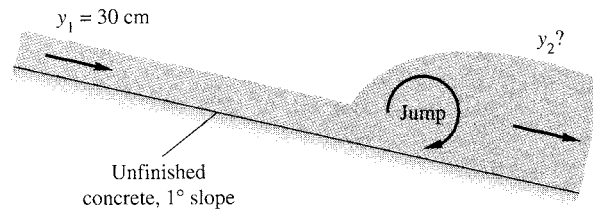
$$\% \text{ dissipation} = \frac{h_f}{E_2} = \frac{3.11 \text{ m}}{5.18 \text{ m}} = \mathbf{60\%} \quad \text{Ans. (d)}$$

Finally, the gap height  $H$  follows from Eq. (10.41), assuming free discharge:

$$q = C_d H \sqrt{2gy_1} = 2.22 \frac{\text{m}^3}{\text{s}\cdot\text{m}} = \left[ \frac{0.61}{\sqrt{1 + 0.61H/5.17 \text{ m}}} \right] H \sqrt{2(9.81)(5.17 \text{ m})},$$

solve  $\mathbf{H = 0.37 \text{ m}}$  Ans. (e)

**10.89** Water 30 cm deep is in uniform flow down a  $1^\circ$  unfinished-concrete slope when a hydraulic jump occurs, as in Fig. P10.89. If the channel is very wide, estimate the water depth  $y_2$  downstream of the jump.



**Fig. P10.89**

**Solution:** For unfinished concrete, take  $n \approx 0.014$ . Compute the upstream velocity:

$$V_1 = \frac{1}{n} R_h^{2/3} S_o^{1/2} = \frac{1}{0.014} (0.3)^{2/3} (\sin 1^\circ)^{1/2} \approx 4.23 \frac{\text{m}}{\text{s}}; \quad Fr_1 = \frac{4.23}{\sqrt{9.81(0.3)}} \approx 2.465$$

$$\frac{y_2}{y_1} = \frac{1}{2} \left[ \sqrt{1 + 8(2.465)^2} - 1 \right] \approx 3.02, \quad y_2 = 3.02(0.3) \approx \mathbf{0.91 \text{ m}} \quad \text{Ans.}$$

**10.90** Modify Prob. 10.89 as follows. Suppose that  $y_2 = 1.5 \text{ m}$  and  $y_1 = 30 \text{ cm}$  but the channel slope is not equal to 1 degree. Determine the proper slope for this condition.

**Solution:** For unfinished concrete take  $n = 0.014$ . The hydraulic jump formula gives the upstream Froude number and velocity:

$$\frac{2y_2}{y_1} = -1 + \sqrt{1 + 8Fr_1^2} = \frac{2(1.5 \text{ m})}{0.3 \text{ m}},$$

$$\text{Solve } Fr_1 = 3.87, \quad V_1 = Fr_1 \sqrt{gy_1} = 3.87 \sqrt{9.81(0.3)} = 6.64 \text{ m/s}$$

$$V_{1,normal} = \frac{1}{0.014} (0.3 \text{ m})^{2/3} \sqrt{S_o} = 6.64 \text{ m/s}$$

$$\text{Solve } S_o = 0.0431 \quad \text{or} \quad \text{about } 2.5^\circ \quad \text{Ans.}$$

**10.91** No doubt you used the horizontal-jump formula (10.43) to solve Probs. 10.89 and 10.90, which is reasonable since the slope is so small. However, Chow [ref. 3, p. 425] points out that hydraulic jumps are *higher* on sloped channels, due to “the weight of the fluid in the jump.” Make a control-volume sketch of a sloping jump to show why this is so. The sloped-jump chart given in Chow’s figure 15-20 may be approximated by the following curve fit:

$$\frac{2y_2}{y_1} \approx \left[ (1 + 8Fr_1^2)^{1/2} - 1 \right] e^{3.5S_0}$$

where  $0 < S_0 < 0.3$  are the channel slopes for which data are available. Use this correlation to modify your solution to Prob. 10.89. If time permits, make a graph of  $y_2/y_1$  ( $\leq 20$ ) versus  $Fr_1$  ( $\leq 15$ ) for various  $S_0$  ( $\leq 0.3$ ).

**Solution:** Include the water weight in a control volume around the jump:

$$\begin{aligned} \sum F_x &= \frac{\rho g}{2} y_1^2 b - \frac{\rho g}{2} y_2^2 b + W \sin \theta \\ &= \dot{m}(V_2 - V_1), \\ \dot{m} &= \rho b y_1 V_1, \quad W \cong \rho g L b y_2 \end{aligned}$$

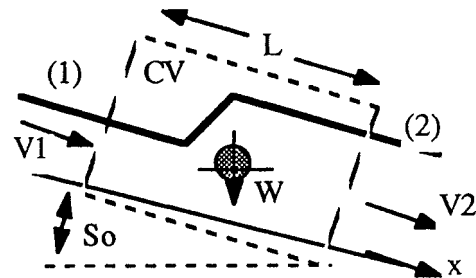


Fig. P10.91

Clean this up and rearrange:

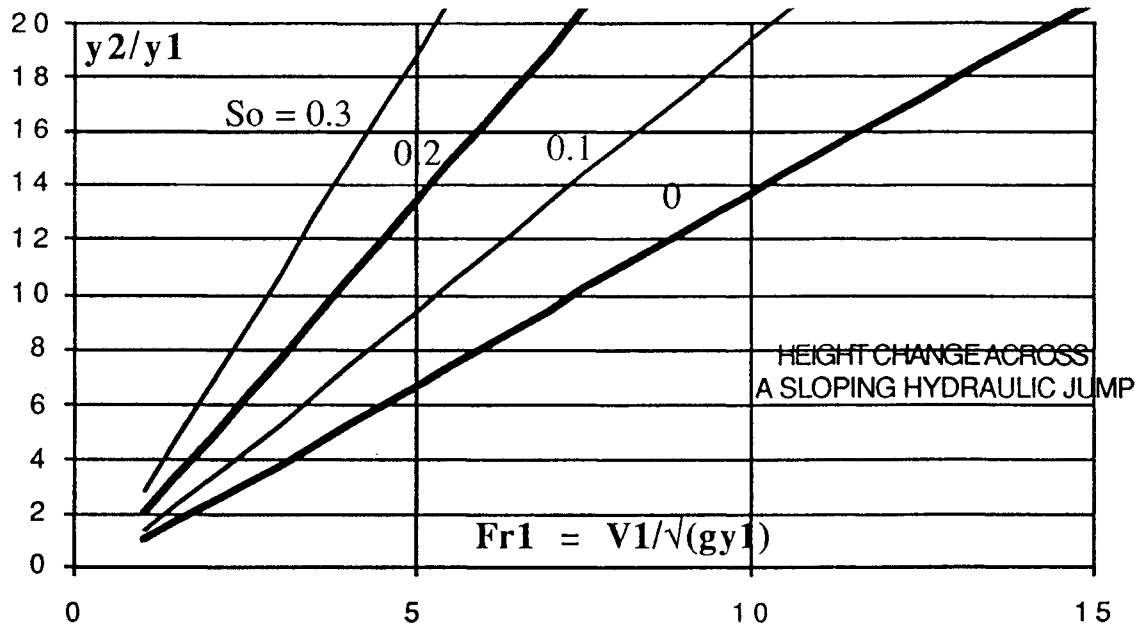
$$r^3(1 - KS_o) - r(\alpha + 1) + \alpha = 0, \quad \text{where } r = \frac{y_2}{y_1}, \quad \alpha = 2Fr_1^2, \quad K = \frac{L}{y_2} \approx 4 \quad \text{or so}$$

The solution to this cubic equation gives the jump height ratio  $r$ . If  $K = 0$  (horizontal jump), the solution is Eq. 10.43. If  $K > 0$  (sloping jump), the jump height increases

roughly as Chow's formula predicts. There is only a slight change to the result of Prob. 10.89:

$$y_{2,\text{new}} \approx y_{2,\text{Prob.10.89}} e^{3.5S_0} \approx 0.91 e^{3.5 \sin 1^\circ} \approx \mathbf{0.97 \text{ m}} \quad \text{Ans.}$$

A plot of Chow's equation is shown below.



**10.92** At the bottom of an 80-ft-wide spillway is a horizontal hydraulic jump with water depths 1 ft upstream and 10 ft downstream. Estimate (a) the flow rate; and (b) the horsepower dissipated.

**Solution:** With water depths known, Eq. 10.43 applies:

$$\frac{y_2}{y_1} = \frac{10}{1} = \frac{1}{2} \left[ \sqrt{1 + 8Fr_1^2} - 1 \right], \quad \text{solve for } Fr_1 = 7.42, \quad V_1 = 7.42\sqrt{32.2(1)} \approx 42 \text{ ft/s}$$

$$\text{Then } Q = V_1 y_1 b = (42)(1)(80) \approx \mathbf{3370 \text{ ft}^3/\text{s}} \quad \text{Ans. (a)}$$

$$h_f = \frac{(y_2 - y_1)^3}{4y_1 y_2} = \frac{(10 - 1)^3}{4(10)(1)} = 18.2 \text{ ft,}$$

$$\text{Power dissipated} = \rho g Q h_f = (62.4)(3370)(18.2)$$

$$= 3.83E6 \frac{\text{ft} \cdot \text{lbf}}{\text{s}} \div 550 \approx \mathbf{7000 \text{ hp}} \quad \text{Ans. (b)}$$



**10.93** Water in a horizontal channel accelerates smoothly over a bump and then undergoes a hydraulic jump, as in Fig. P10.93. If  $y_1 = 1$  m and  $y_3 = 40$  cm, estimate (a)  $V_1$ ; (b)  $V_3$ ; (c)  $y_4$ ; and (d) the bump height  $h$ .

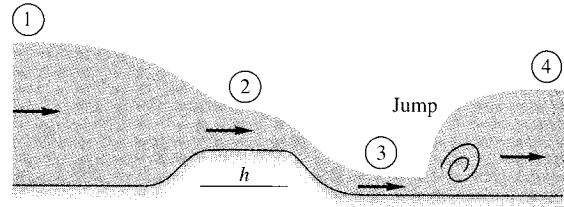


Fig. P10.93

**Solution:** Assume frictionless flow except in the jump. From point 1 to point 3:

$$\text{Energy: } E_1 = 1 + \frac{V_1^2}{2(9.81)} = E_3 = 0.4 + \frac{V_3^2}{2(9.81)}; \quad \text{Continuity: } V_1(1.0) = V_3(0.4)$$

Solve simultaneously by iteration for  $V_1 \approx 1.50 \frac{\text{m}}{\text{s}}$  Ans. (a)  $V_3 = 3.74 \frac{\text{m}}{\text{s}}$  Ans. (b)

The flow after the bump is supercritical:  $Fr_3 = 3.74/\sqrt{[9.81(0.4)]} \approx 1.89$ . For the jump,

$$\frac{y_4}{y_3} = \frac{1}{2} \left[ \sqrt{1 + 8(1.89)^2} - 1 \right] = 2.22, \quad y_4 = 2.22(0.4) \approx 0.89 \text{ m} \quad \text{Ans. (c)}$$

Finally, use energy from “1” to “2” and note that the bump flow must be *critical*:

$$E_1 = 1.115 = E_2 = y_2 + \frac{V_2^2}{2g} + h; \quad V_1 y_1 = 1.50 = V_2 y_2; \quad \text{and: } V_2 = \sqrt{9.81 y_2}$$

Solve simultaneously for  $y_2 \approx 0.61$  m;  $V_2 \approx 2.45$  m/s;  $h \approx 0.20$  m Ans. (d)

**10.94** For the flow pattern of Fig. P10.93, consider the following different, and barely sufficient, data. The upstream velocity  $V_1 = 1.5$  m/s, and the bump height  $h$  is 27 cm. Find (a)  $y_1$ ; (b)  $y_2$ ; (c)  $y_3$ ; and (d)  $y_4$ .

**Solution:** Begin by writing out the various useful equations:

$$E_1 = y_1 + \frac{V_1^2}{2g} = E_2 = y_2 + \frac{V_2^2}{2g} + h_{\text{bump}} = E_3 = y_3 + \frac{V_3^2}{2g} \neq E_4$$

$$q = V_1 y_1 = V_2 y_2 = V_3 y_3 = V_4 y_4$$

$$\frac{2y_4}{y_3} = -1 + \sqrt{1 + 8Fr_3^2} \quad \text{where} \quad Fr_3 = \frac{V_3}{\sqrt{gy_3}}$$

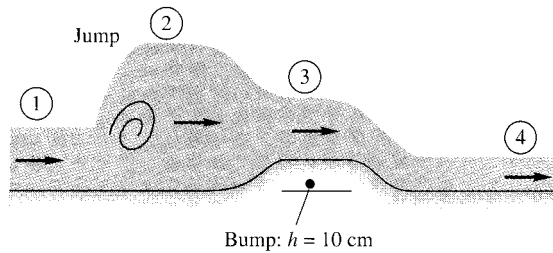
$$\text{Critical flow over the bump: } Fr_2 = 1.0, \quad V_2 = \sqrt{gy_2}$$

Our only data are  $V_1 = 1.5$  m/s and  $h = 0.27$  m. Our best hope is to type all these relations out in EES and limit all variables to be positive numbers. The final results are:

$$y_1 = \mathbf{1.18\text{ m}} \quad \text{Ans. (a);} \quad y_2 = \mathbf{0.684\text{ m}} \quad \text{Ans. (b);}$$

$$y_3 = \mathbf{0.430\text{ m}} \quad \text{Ans. (c);} \quad y_4 = \mathbf{1.024\text{ m}} \quad \text{Ans. (d)}$$

**10.95** A 10-cm-high bump in a wide horizontal channel creates a hydraulic jump just upstream and the flow pattern in Fig. P10.95. Neglect losses except in the jump. If  $y_3 = 30$  cm, estimate (a)  $V_4$ ; (b)  $y_4$ ; (c)  $V_1$ ; and (d)  $y_1$ .



**Fig. P10.95**

**Solution:** Since section “2” is subcritical and “4” is supercritical, assume “3” is *critical*:

$$V_3 = \sqrt{gy_3} = \sqrt{9.81(0.3)} = 1.72 \frac{\text{m}}{\text{s}}, \quad \text{thus } q = V_j y_j|_{2,3,4} = 1.72(0.3) = 0.515 \text{ m}^3/\text{s} \cdot \text{m}$$

$$y_3 + \frac{V_3^2}{2g} + h = 0.3 + \frac{(1.72)^2}{2(9.81)} + 0.1 = 0.55 \text{ m} = E_4 = y_4 + \frac{V_4^2}{2(9.81)}; \quad \text{and } V_4 y_4 = 0.515$$

$$\text{Solve for } y_4 \approx \mathbf{0.195\text{ m}} \quad \text{Ans. (b);} \quad V_4 \approx \mathbf{2.64 \frac{m}{s}} \quad \text{Ans. (a)}$$

$$\text{Also, } E_2 = 0.55 = y_2 + \frac{V_2^2}{2g} \quad \text{and} \quad V_2 y_2 = 0.515, \quad \text{solve } y_2 \approx 0.495 \text{ m, } V_2 \approx 1.04 \text{ m/s}$$

$$Fr_2 = \frac{1.04}{\sqrt{9.81(0.495)}} \approx 0.472, \quad \text{Jump: } \frac{y_1}{y_2} = \frac{1}{2} \left[ \sqrt{1 + 8(0.472)^2} - 1 \right] = 0.334 = \frac{y_1}{0.495}$$

$$\text{Thus } y_1 \approx \mathbf{0.165\text{ m}} \quad \text{Ans. (d);} \quad V_1 = \frac{0.515}{0.165} \approx \mathbf{3.11 \frac{m}{s}} \quad \text{Ans. (c)}$$

**10.96** Show that the Froude numbers on either side of a hydraulic jump are related by the simple formula  $Fr_2 = Fr_1(y_1/y_2)^{3/2}$ .

**Solution:** This relation follows immediately from continuity,  $q = Vy = \text{constant}$ :

$$\frac{Fr_2}{Fr_1} = \frac{V_2 \sqrt{gy_1}}{\sqrt{gy_2} V_1} = \frac{V_2}{V_1} \sqrt{\frac{y_1}{y_2}} = \frac{q y_1}{y_2 q} \sqrt{\frac{y_1}{y_2}} = \left( \frac{y_1}{y_2} \right)^{3/2} \quad \text{Ans.}$$

**10.97** A brickwork rectangular channel 4 m wide is flowing at  $8.0 \text{ m}^3/\text{s}$  on a slope of  $0.1^\circ$ . Is this a mild, critical, or steep slope? What type of gradually-varied-solution curve are we on if the local water depth is (a) 1 m; (b) 1.5 m; (c) 2 m?

**Solution:** For brickwork, take  $n \approx 0.015$ . Then, with  $q = Q/b = 8/4 = 2.0 \text{ m}^3/\text{s}\cdot\text{m}$ ,

$$Q = 8 \frac{\text{m}^3}{\text{s}} = \frac{1}{n} A R_h^{2/3} S_o^{1/2} = \frac{1}{0.015} (4y_n) \left( \frac{4y_n}{4+2y_n} \right)^{2/3} (\sin 0.1^\circ)^{1/2},$$

$$\text{solve for } y_n \approx 0.960 \text{ m}$$

whereas  $y_c = (q^2/g)^{1/3} = [(2)^2/9.81]^{1/3} \approx 0.742 \text{ m}$ . Since  $y_n > y_c$ , **slope is mild** *Ans.*

All three of the given depths—1.0, 1.5, and 2.0 meters—are above  $y_n$  on Fig. 10.14c, hence **all three are on M-1 curves.** *Ans.*

**10.98** A gravelly-earth wide channel is flowing at  $10.0 \text{ m}^3/\text{s}$  per meter on a slope of  $0.75^\circ$ . Is this a mild, critical, or steep slope? What type of gradually-varied-solution curve are we on if the local water depth is (a) 1 m; (b) 2 m; (c) 3 m?

**Solution:** For gravelly earth, take  $n \approx 0.025$ . Then, with  $R_h = y$  itself,

$$q = 10 \frac{\text{m}^3}{\text{s}\cdot\text{m}} = \frac{1}{n} \frac{A}{b} R_h^{2/3} S_o^{1/2} = \frac{1}{0.025} (y_n) y_n^{2/3} (\sin 0.75^\circ)^{1/2}, \quad \text{solve for } y_n \approx 1.60 \text{ m}$$

whereas  $y_c = (q^2/g)^{1/3} = [(10)^2/9.81]^{1/3} \approx 2.17 \text{ m}$ . Since  $y_c > y_n$ , **slope is steep** *Ans.*

The three given depths fits nicely into the spaces between  $y_n$  and  $y_c$  in Fig. 10.14a:

$y = 1 \text{ m} < y_n < y_c$ : **S-3 curve** *Ans.* (a)  $y_n < y = 2 \text{ m} < y_c$ : **S-2 curve** *Ans.* (b)

$y_n < y_c < y = 3 \text{ m}$ : **S-1 curve** *Ans.* (c)

**10.99** A clay tile V-shaped channel, of included angle  $60^\circ$ , is flowing at  $1.98 \text{ m}^3/\text{s}$  on a slope of  $0.33^\circ$ . Is this a mild, critical, or steep slope? What type of gradually-varied-solution curve are we on if the local water depth is (a) 1 m; (b) 2 m; (c) 3 m?

**Solution:** For clay tile, take  $n \approx 0.014$ . For a  $60^\circ$  Vee-channel, from Example 10.5 of the text,  $A = y^2 \cot 60^\circ$  and  $R_h = (y/2) \cos 60^\circ$ . For uniform flow,

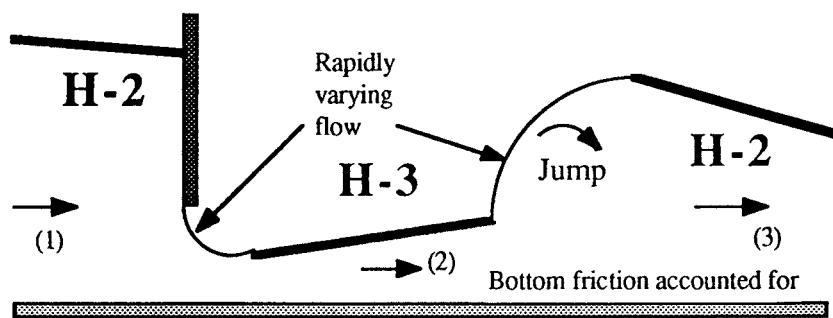
$$Q = 1.98 = \frac{1}{n} A R_h^{2/3} S_o^{1/2} = \frac{1}{0.014} (y^2 \cot 60^\circ) \left( \frac{y}{2} \cos 60^\circ \right)^{2/3} (\sin 0.33^\circ)^{1/2},$$

solve for  $y_n \approx 1.19$  m; whereas  $y_c = \left( \frac{2Q^2}{g \cot^2 60^\circ} \right)^{1/5} \approx 1.19$  also. Slope is **critical**. *Ans.*

Fig. 10.14b:  $y = 1$  m  $< y_c$ : **C-3 curve** *Ans.* (a);  $y = 2$  or  $3$  m  $> y_c$ : **C-1 curve** *Ans.* (b, c)

**10.100** If bottom friction is included in the sluice-gate flow of Prob. 10.84, the depths ( $y_1, y_2, y_3$ ) will vary with  $x$ . Sketch the type and shape of gradually-varied solution curve in each region (1,2,3) and show the regions of rapidly-varying flow.

**Solution:** The expected curves are all of the “H” (horizontal) type and are shown below:



*Ans.*

Fig. P10.100

**10.101** Consider the gradual change from the profile beginning at point  $a$  in Fig. P10.101 on a mild slope  $S_{o1}$  to a *mild* but steeper slope  $S_{o2}$  downstream. Sketch and label the gradually-varied solution curve(s)  $y(x)$  expected.

**Solution:** There are two possible profiles, depending upon whether or not the initial M-2 profile slips below the new normal depth  $y_{n2}$ . These are shown on the next page:

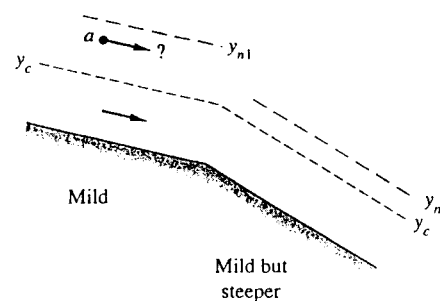
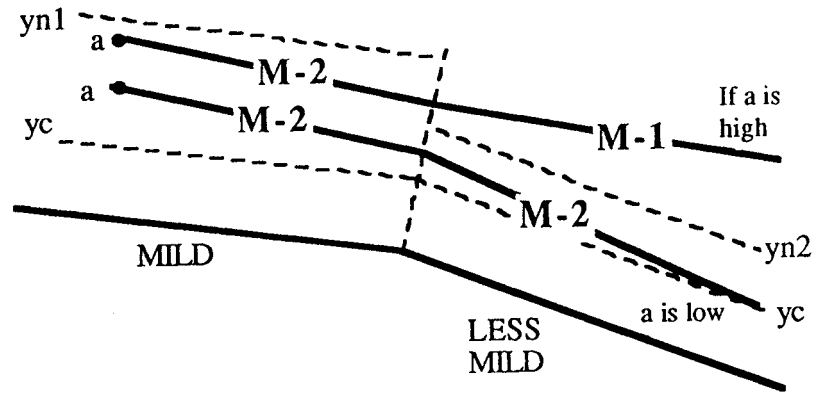


Fig. P10.101



**10.102** The wide channel flow in Fig. P10.102 changes from a steep slope to one even steeper. Beginning at points a and b, sketch and label the water surface profiles which are expected for gradually-varied flow.

**Solution:** The point-*a* curve will approach each normal depth in turn. Point-*b* curves, depending upon initial position, may approach  $y_{n2}$  either from above or below, as shown in the sketch below.

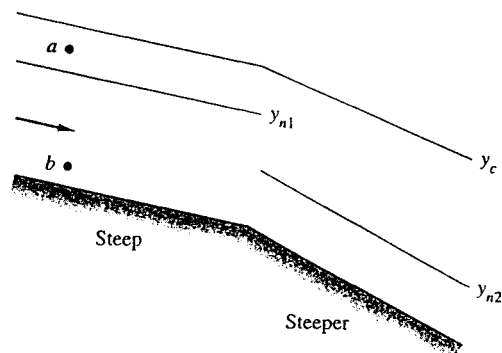
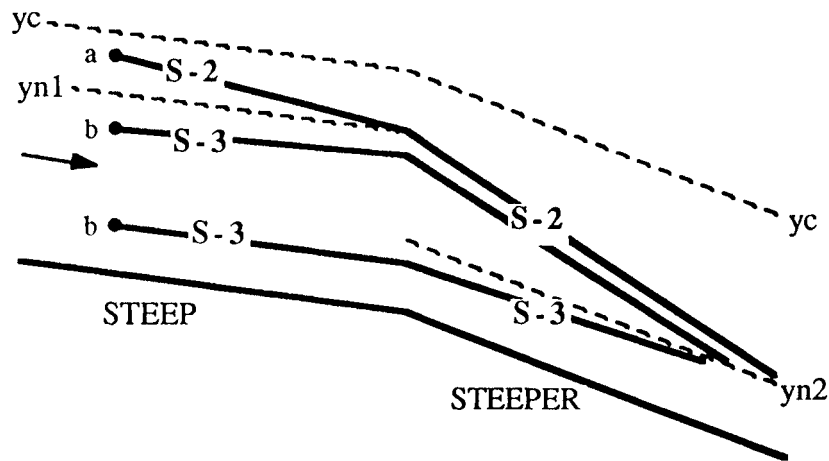


Fig. P10.102



**10.103** A circular painted-steel channel, of radius 50 cm, is running half-full at  $1.2 \text{ m}^3/\text{s}$  on a slope of 5 m/km. Determine (a) whether the slope is mild or steep; and (b) what type

of gradually-varied solution applies at this point. (c) Use the approximate method of Eq. (10.52), and a single depth increment  $\Delta y = 5$  cm, to calculate the estimated  $\Delta x$  for this new  $y$ .

**Solution:** (a) To classify the slope, we need to compute  $y_n$  and  $y_c$ . Take  $n = 0.014$ . The geometric properties of the partly-full circular duct are taken from the discussion of Eq. (10.20):

$$A = R^2 \left( \theta - \frac{\sin 2\theta}{2} \right); \quad P = 2R\theta; \quad R_h = \frac{R}{2} \left( 1 - \frac{\sin 2\theta}{2\theta} \right); \quad y = R[1 + \sin(90^\circ - \theta)]$$

where  $\theta$  is measured from the bottom of the circle (see Fig. 10.6a). For normal flow,

$$Q = 1.2 \frac{\text{m}^3}{\text{s}} = \frac{1}{n} A R_h^{2/3} \sqrt{S_o} = \frac{1}{0.014} \left[ (0.5)^2 \left( \theta - \frac{\sin 2\theta}{2} \right) \right] \left[ \frac{0.5}{2} \left( 1 - \frac{\sin 2\theta}{2\theta} \right) \right]^{2/3} \sqrt{0.005}$$

EES seems indicated, and the solution is  $\theta_n = 107.9^\circ$  and  $y_n = \mathbf{0.654 \text{ m}}$ . Next, for this non-rectangular channel, critical flow occurs when

$$A_c = \left( \frac{b_o Q^2}{g} \right)^{1/3} \quad \text{where } b_o = 2R \cos(90^\circ - \theta) \quad \text{and} \quad Q = 1.2 \frac{\text{m}^3}{\text{s}}$$

Again, EES is handy, and the solution is  $\theta_c = 104.8^\circ$  and  $y_c = \mathbf{0.628 \text{ m}}$ .

(a) Thus  $y_c < y_n$ , and the channel slope is therefore **mild**. *Ans.* (a)

(b) From Fig. 10.14c, since we are starting at  $y = 0.5$  m, which is less than  $y_c$ , we will proceed for  $Fr > 1$  along an **M-3 curve**. *Ans.* (b)

(c) We are to find  $\Delta x$  required to move from  $y = 0.5$  m to  $y = 0.55$  m in one step ( $\Delta y = 0.05$  m), using the numerical method of Eq. (10.52). At the initial depth,

$$y_1 = 0.5 \text{ m}; \quad V_1 = 3.06 \text{ m/s}; \quad E_1 = 0.976 \text{ m}; \quad R_{h1} = 0.25 \text{ m}; \quad S_1 = n^2 V^2 / R_h^{4/3} = 0.0116$$

Similarly, at the final depth,

$$y_2 = 0.55 \text{ m}; \quad V_2 = 2.71 \text{ m/s}; \quad E_2 = 0.925 \text{ m}; \quad R_{h2} = 0.265 \text{ m}; \quad S_2 = n^2 V^2 / R_h^{4/3} = 0.00847$$

The numerical approximation, Eq. (10.52), then predicts:

$$\Delta x = \frac{E_2 - E_1}{S_o - S_{avg}} = \frac{0.925 - 0.976 \text{ m}}{0.005 - (0.0116 + 0.00847)/2} = \frac{-0.051}{-0.00504} \approx \mathbf{10.1 \text{ m}} \quad \text{Ans.}$$

**10.104** The rectangular channel flow in Fig. P10.104 expands to a cross-section 50% wider. Beginning at points  $a$  and  $b$ , sketch and label the water-surface profiles which are expected for gradually-varied flow.

**Solution:** Three types of dual curves are possible: S2/S2, S3/S2, and S3/S3, as shown:

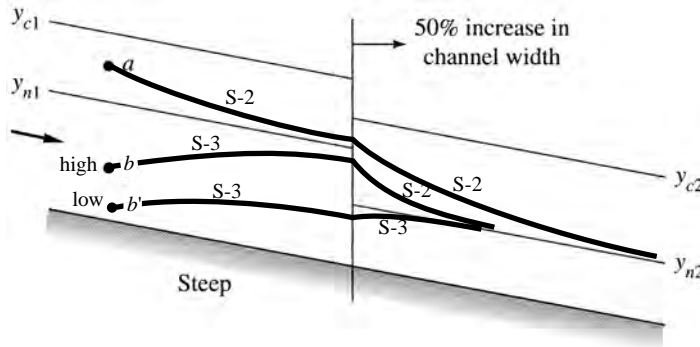


Fig. P10.104

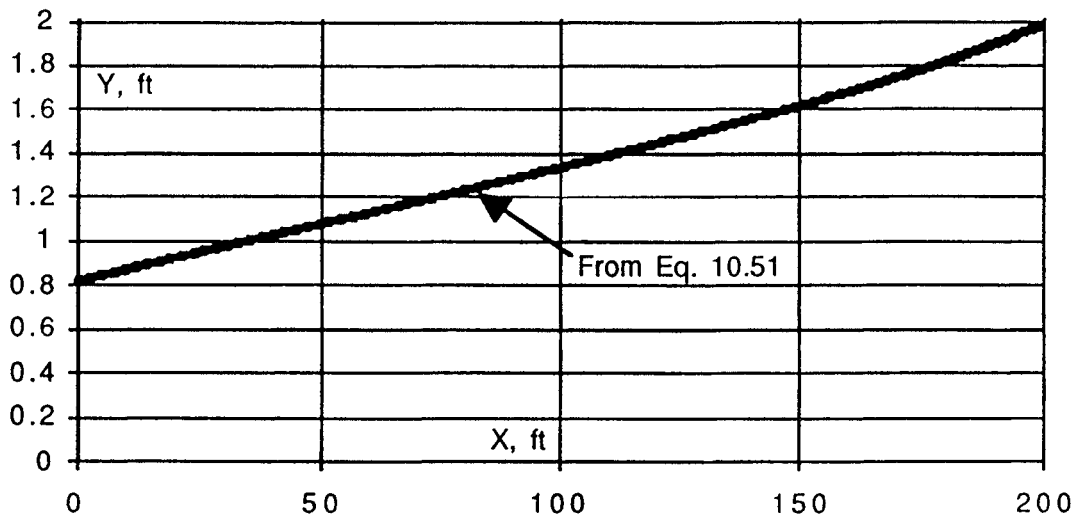
**10.105** In Prob. 10.84 the frictionless solution is  $y_2 = 0.82$  ft, which we denote as  $x = 0$  just downstream of the gate. If the channel is horizontal with  $n = 0.018$  and there is no hydraulic jump, compute from gradually-varied theory the downstream distance where  $y = 2.0$  ft.

**Solution:** Given  $q = Vy = 20$  ft<sup>3</sup>/s-ft, the critical depth is  $y_c = (q^2/32.3)^{1/3} = 2.32$  ft, hence we are on an **H-2** curve (see Fig. 10.14d) which will approach  $y_c$  from below. We solve the basic differential equation 10.51 for horizontal wide-channel flow ( $S_o = 0$ ):

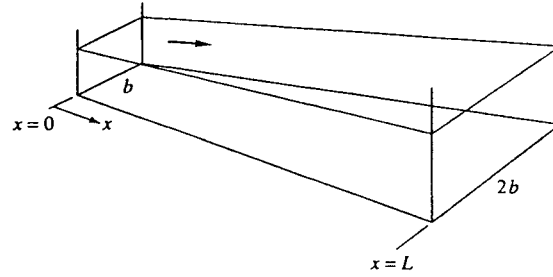
$$\frac{dy}{dx} = \frac{-n^2 q^2 / (\alpha^2 y^{10/3})}{1 - q^2 / (gy^3)} = - \frac{(0.018)^2 (20)^2 / (2.208 y^{10/3})}{1 - (20)^2 / (32.2 y^3)} \quad \text{for } y_0 = 0.82 \text{ ft at } x = 0 \text{ ft.}$$

The water level increases until  **$y = 2.0$  ft at  $x \approx 200$  ft.** *Ans.*

The complete solution  $y(x)$  is shown below.



**10.106** A rectangular channel with  $n = 0.018$  and a constant slope of 0.0025 increases its width linearly from  $b$  to  $2b$  over a distance  $L$ , as in Fig. P10.106. (a) Determine the variation  $y(x)$  along the channel if  $b = 4$  m,  $L = 250$  m,  $y(0) = 1.05$  m, and  $Q = 7$  m<sup>3</sup>/s. (b) Then, if your computer program is working well, determine  $y(0)$  for which the exit flow will be exactly critical.



**Fig. P10.106**

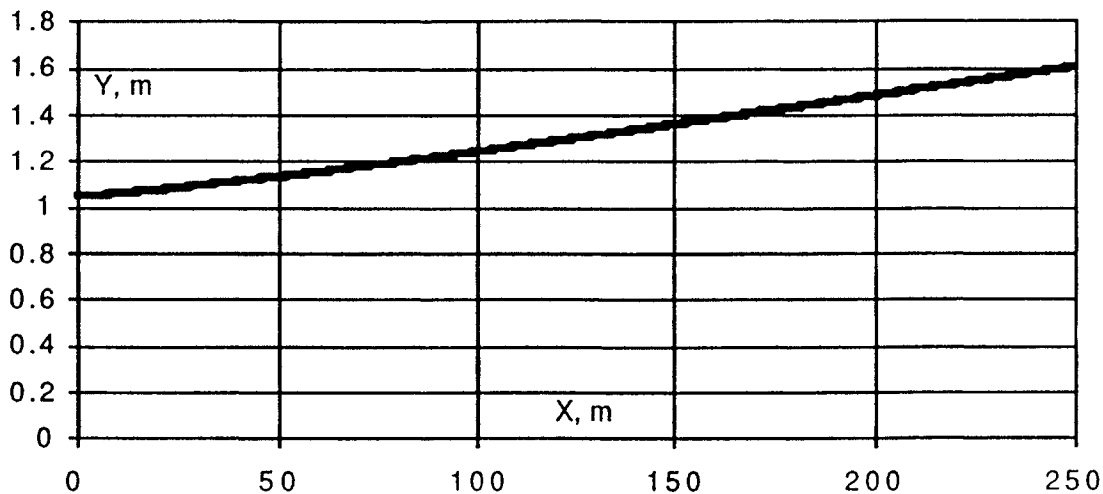
**Solution:** We are to solve the gradually-varied-flow relation, Eq. 10.51:

$$\frac{dy}{dx} = \frac{S_o - S}{1 - V^2/(9.81y)}, \quad \text{where } S = \frac{n^2 V^2}{R_h^{4/3}}, \quad V = \frac{Q}{by}, \quad R_h = \frac{by}{b+2y}, \quad b = 4 \left( 1 + \frac{x}{250} \right)$$

For reference purposes, compute  $y_c = 0.68$  m and  $y_n = 0.88$  m at  $x = 0$ , compared to  $y_c = 0.43$  m and  $y_n = 0.53$  m at  $x = 250$  m. For initial depth  $y(0) = 1.05$ , we are on an M-2 curve (see Fig. 10.14c) and we compute  $y(L) \approx 1.61$  m. *Ans. (a)*

The curve  $y(x)$  is shown below.

The writer **cannot find any  $y(0)$  for which the exit flow is critical.** *Ans. (b)*



This figure shows  $y(x)$  for Prob. 10.106 when  $y(0) = 1.05$  m.

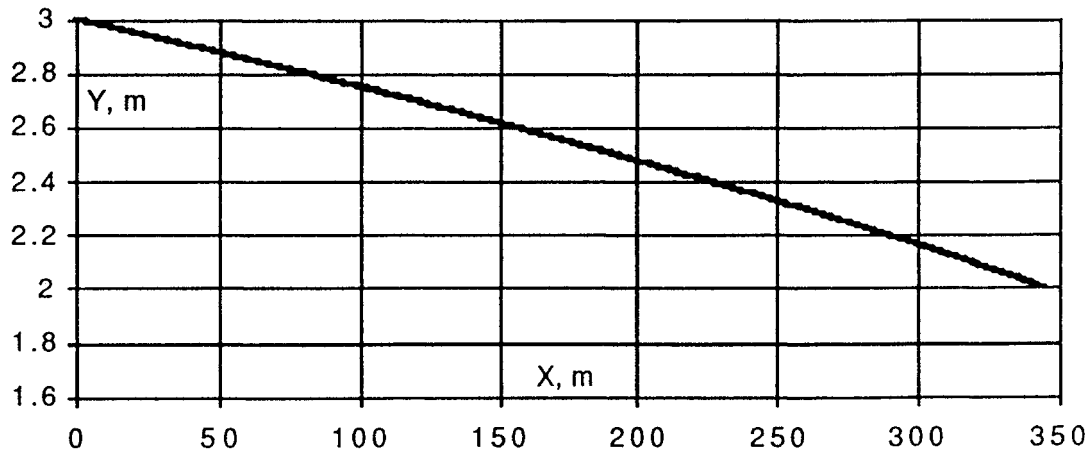


**10.107** A clean-earth wide-channel flow is flowing up an *adverse* slope with  $S_o = -0.002$ . If the flow rate is  $q = 4.5 \text{ m}^3/\text{s}\cdot\text{m}$ , use gradually-varied theory to compute the distance for the depth to drop from 3.0 to 2.0 meters.

**Solution:** For clean earth, take  $n \approx 0.022$ . The basic differential equation is

$$\frac{dy}{dx} = \frac{S_o - n^2 q^2 / (\alpha^2 y^{10/3})}{1 - q^2 / (g y^3)}, \quad S_o = -0.002, \quad \alpha = 1.0, \quad q = 4.5, \quad n = 0.022, \quad y(0) = 3.0 \text{ m}$$

The complete graph  $y(x)$  is shown below. The depth = 2.0 m when  $x = 345 \text{ m}$ . *Ans.*

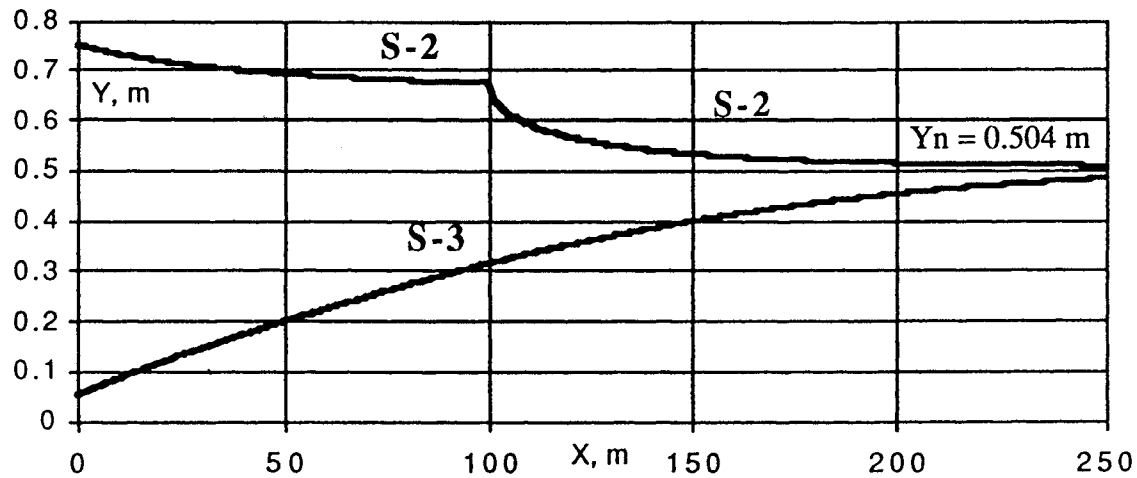


**10.108** Illustrate Prob. 10.104 with a numerical example. Let the channel be rectangular with a width  $b_1 = 10 \text{ m}$  for  $0 < x < 100 \text{ m}$ , expanding to  $b_2 = 15 \text{ m}$  for  $100 < x < 250 \text{ m}$ . The flow rate is  $27 \text{ m}^3/\text{s}$ , and  $n = 0.012$ . Compute the water depth at  $x = 250 \text{ m}$  for initial depth  $y(0)$  equal to (a) 75 cm and (b) 5 cm. Compare your results with the discussion in Prob. 10.104.

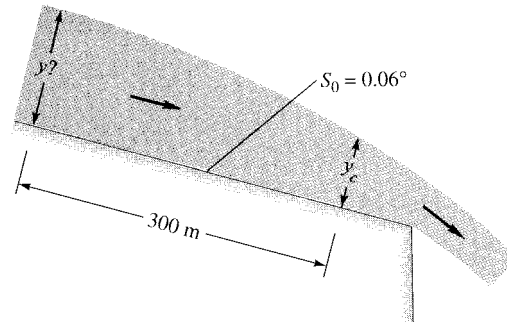
**Solution:** The basic differential equation is

$$\frac{dy}{dx} = \frac{S_o - n^2 V^2 / R_h^{4/3}}{1 - Q^2 / (g b^2 y^3)}, \quad \text{where } V = \frac{Q}{A}, \quad R_h = \frac{b y}{b + 2y}, \quad y(0) = 75 \text{ cm and } 5 \text{ cm}$$

The two graphs are shown on the next page. The upper is S-2/S-2, the lower curve is S-3/S-3, both approach the downstream normal depth  $y_n \approx 0.504 \text{ m}$ . *Ans.*



**10.109** Figure P10.109 illustrates a free overfall or *dropdown* flow pattern, where a channel flow accelerates down a slope and falls freely over an abrupt edge. As shown, the flow reaches critical just before the overfall. Between  $y_c$  and the edge the flow is rapidly varied and does not satisfy gradually varied theory. Suppose that the flow rate is  $q = 1.3 \text{ m}^3/(\text{s}\cdot\text{m})$  and the surface is unfinished cement. Use Eq. (10.51) to estimate the water depth 300 m upstream as shown.



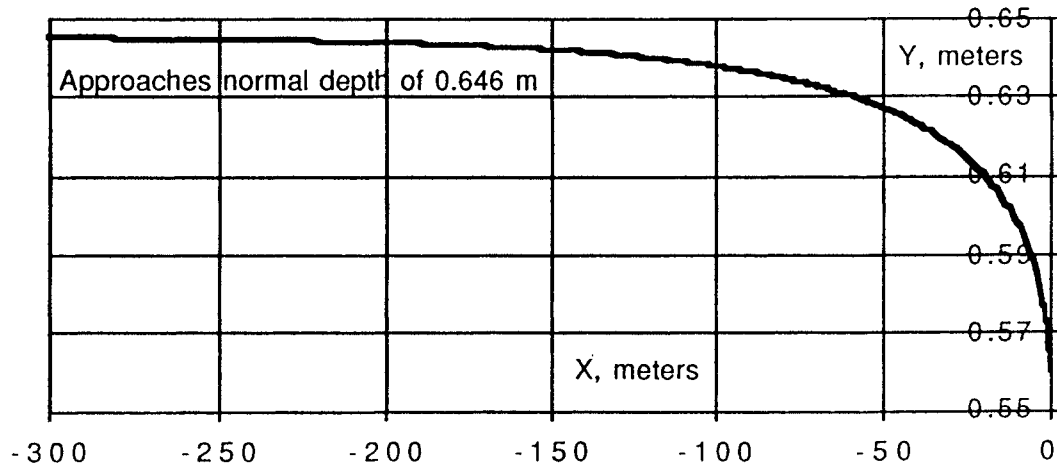
**Fig. P10.109**

**Solution:** For unfinished cement, take  $n \approx 0.012$ . The basic differential equation is

$$\frac{dy}{dx} = \frac{S_0 - n^2 q^2 / y^{10/3}}{1 - q^2 / (g y^3)}, \quad S_0 = \sin(0.06^\circ) = 0.00105, \quad q = 1.3 \frac{\text{m}^3}{\text{s}\cdot\text{m}}, \quad n = 0.012,$$

$$y(0) = y_{\text{critical}} = (q^2/g)^{1/3} = [(1.3)^2/9.81]^{1/3} = 0.556 \text{ m}, \quad \text{integrate for } \Delta x < 0.$$

The solution grows rapidly at first and then approaches, at about 150 m upstream, the normal depth of **0.646 m** for this flow rate and roughness. The profile is shown on the next page.



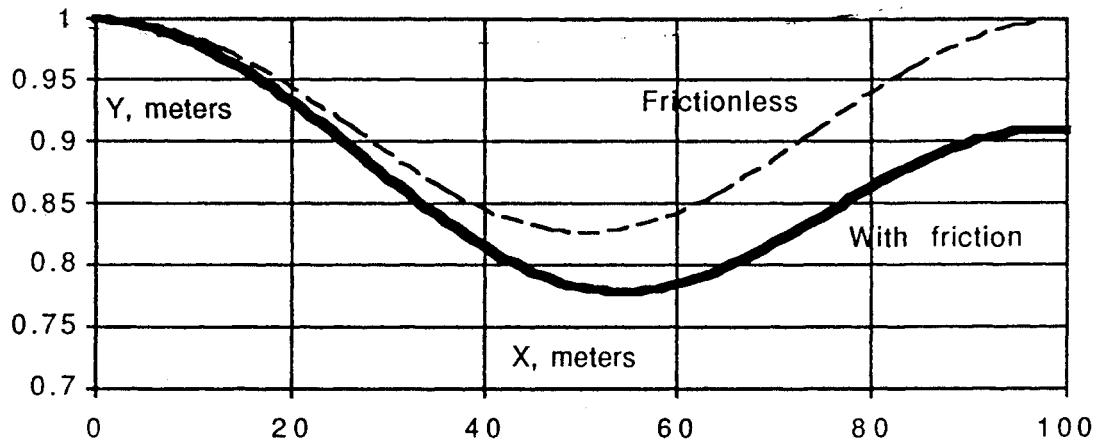
**10.110** We assumed frictionless flow in solving the bump case, Prob. 10.65, for which  $V_2 = 1.21$  m/s and  $y_2 = 0.826$  m over the crest when  $h_{\max} = 15$  cm,  $V_1 = 1$  m/s, and  $y_1 = 1$  m. However, if the bump is long and rough, friction may be important. Repeat Prob. 10.65 for the same bump shape,  $h = 0.5h_{\max}[1 - \cos(2\pi x/L)]$ , to compute conditions (a) at the crest and (b) at the end of the bump,  $x = L$ . Let  $h_{\max} = 15$  cm and  $L = 100$  m, and assume a clean-earth surface.

**Solution:** For clean earth, take  $n = 0.022$ . The basic differential equation is

$$\frac{dy}{dx} = \frac{S_o - n^2 q^2 y^{-10/3}}{1 - q^2/(gy^3)}, \quad q = 1.0 \frac{\text{m}^3}{\text{s} \cdot \text{m}},$$

$$S_o = \left. \frac{dh}{dx} \right|_{\text{bump}} = -\frac{\pi h_{\max}}{2L} \sin\left(\frac{2\pi x}{L}\right), \quad y(0) = 1 \text{ m}$$

We integrate this for clean earth ( $n = 0.022$ ) and also for *frictionless* flow (Prob. 10.65),  $n = 0$ . The results are shown on the next page. The frictionless profile drops to  $y = 0.826$  m at the crest and returns to  $y = 1.0$  m at the end,  $x = L = 100$  m. The *frictional* flow drops lower, to  $y = \mathbf{0.782}$  m at the crest [Ans. (a)] and even lower, to  $y = 0.778$  m at  $x = 54$  m, and then does not recover fully, ending up at  $y = \mathbf{0.909}$  m at  $x = L$ . [Ans. (b)]



**10.111** Solve Prob. 10.105 (a horizontal variation along an H-3 curve) by the approximate method of Eq. (10.52), beginning at  $(x, y) = (0, 0.82 \text{ ft})$  and using a depth increment  $\Delta y = 0.2 \text{ ft}$ . (The final increment should be  $\Delta y = 0.18 \text{ ft}$  to bring us exactly to  $y = 2.0 \text{ ft}$ .)

**Solution:** The procedure is explained in Example 10.10 of the text. Recall that  $n = 0.018$  and the flow rate is  $q = 20 \text{ ft}^3/\text{s}/\text{ft}$ . The numerical method uses Eq. (10.52) to compute  $\Delta x$  for a given  $\Delta y$ . The “friction slope”  $S = n^2 V^2 / (2.208 y^{4/3})$ . The bed slope  $S_o = 0$  (horizontal). The tabulated results below indicate that a depth of 2.0 ft is reached at a distance  $x \approx 195 \text{ ft}$  downstream.

[NOTE: Prob. 10.105 had a more accurate numerical solution  $x \approx 200 \text{ ft}$ .]

$y, \text{ ft}$	$V = 20/y$	$E = y + V^2/2g$	$S$	$S\text{-avg}$	$\Delta x, \text{ ft}$	$x = \sum \Delta x, \text{ ft}$
0.82	24.390	10.057	0.1137	n/a	n/a	0.000
1.02	19.608	6.990	0.0549	0.084	36.37	36.37
1.22	16.393	5.393	0.0303	0.043	37.49	73.86
1.42	14.085	4.500	0.0182	0.024	36.82	110.68
1.62	12.346	3.987	0.0118	0.015	34.25	144.93
1.82	10.989	3.695	0.0080	0.010	29.56	174.49
<b>2.00</b>	10.000	3.553	0.0058	0.007	20.63	<b>195.12</b>

**10.112** The clean-earth channel in Fig. P10.112 is 6 m wide and slopes at  $0.3^\circ$ . Water flows at  $30 \text{ m}^3/\text{s}$  in the channel and enters a reservoir so that the channel depth is 3 m just before the entry. Assuming gradually-varied flow, how far is  $L$  to a point upstream where  $y = 2\text{m}$ ? What type of curve is the water surface?

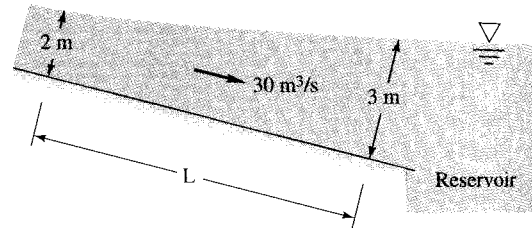


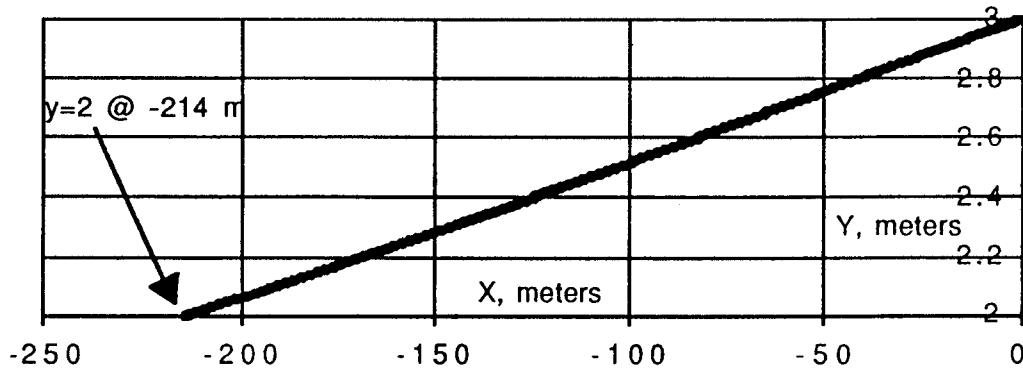
Fig. P10.112

**Solution:** For clean earth, take  $n \approx 0.022$ . The differential equation is Eq. 10.51:

$$\frac{dy}{dx} = \frac{S_o - n^2 Q^2 / (A^2 R_h^{4/3})}{1 - Q^2 b / (g A^3)}, \quad \text{where } S_o = 0.3^\circ, Q = 30 \frac{\text{m}^3}{\text{s}}, b = 6 \text{ m}, A = by, y(0) = 3.0$$

To begin, compute  $y_n \approx 1.51 \text{ m}$  and  $y_c \approx 1.37 \text{ m}$ , hence  $y_c < y_n < y$ : we are on a *mild* slope above the normal depth, hence we are on an **M-1** curve. *Ans.*

Begin at  $y(0) = 3 \text{ m}$  and integrate backwards ( $\Delta x < 0$ ) until  $y = 2 \text{ m}$  at  **$L = 214 \text{ m}$** . *Ans.*



**10.113** Figure P10.113 shows a channel contraction section often called a *venturi flume* [from Ref. 23 of Chap. 10], because measurements of  $y_1$  and  $y_2$  can be used to meter the flow rate. Show that if losses are neglected and the flow is one-dimensional and subcritical, the flow rate is given by

$$Q = \left[ \frac{2g(y_1 - y_2)}{1/(b_2^2 y_2^2) - 1/(b_1^2 y_1^2)} \right]^{1/2}$$

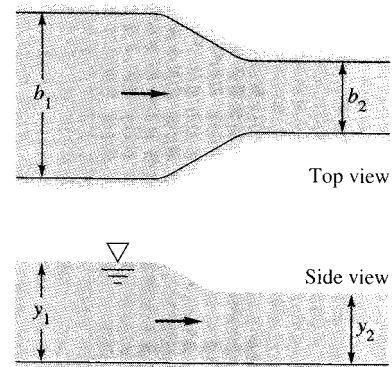


Fig. P10.113

Apply this to the special case  $b_1 = 3$  m,  $b_2 = 2$  m, and  $y_1 = 1.9$  m. Find the flow rate (a) if  $y_2 = 1.5$  m; and (b) find the depth  $y_2$  for which the flow becomes critical in the throat.

**Solution:** Given the water depths, continuity and energy allow us to eliminate one velocity:

$$\text{Continuity: } Q = V_1 y_1 b_1 = V_2 y_2 b_2; \quad \text{Energy: } y_1 + \frac{V_1^2}{2g} = y_2 + \frac{V_2^2}{2g}$$

$$\text{Eliminate } V_1 \text{ to obtain } V_2 = [2g(y_1 - y_2)/(1 - \alpha^2)]^{1/2} \quad \text{where } \alpha = (y_2 b_2)/(y_1 b_1)$$

$$\text{or: } Q = V_2 y_2 b_2 = \left[ \frac{2g(y_1 - y_2)}{\{b_2^{-2} y_2^{-2} - b_1^{-2} y_1^{-2}\}} \right]^{1/2} \quad \text{Ans.}$$

Evaluate the solution we just found:

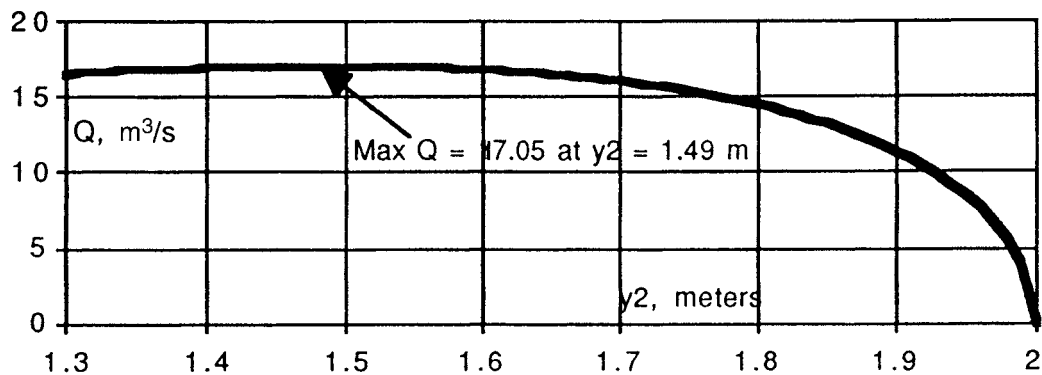
$$Q = \left[ \frac{2(9.81)(1.9 - 1.5)}{(2)^{-2}(1.5)^{-2} - (3)^{-2}(1.9)^{-2}} \right]^{1/2} \approx 9.88 \frac{\text{m}^3}{\text{s}} \quad \text{Ans. (a)}$$

For this part (a),  $Fr_2 = V_2/\sqrt{gy_2} \approx 0.86$ .

(b) To find critical flow, keep reducing  $y_2$  until  $Fr_2 = 1.0$ . This converges to  $y_2 \approx 1.372$  m. [for which  $Q = 10.1$  m<sup>3</sup>/s] Ans. (b)

**10.114** Investigate the possibility of *choking* in the venturi flume of Fig. P10.113. Let  $b_1 = 4$  ft,  $b_2 = 3$  ft, and  $y_1 = 2$  ft. Compute the values of  $y_2$  and  $V_1$  for a flow rate of (a) 30 ft<sup>3</sup>/s and (b) 35 ft<sup>3</sup>/s. Explain your vexation.

**Solution:** You can't get anywhere near either  $Q = 30$  or  $Q = 35$  m<sup>3</sup>/s, the flume **chokes** (becomes critical in the throat) at about  $Q = 17.05$  m<sup>3</sup>/s, when  $y_2 \approx 1.49$  m, as shown in the graph below. Ans.



**10.115** Gradually varied theory, Eq. (10.49), neglects the effect of *width* changes,  $db/dx$ , assuming that they are small. But they are not small for a short, sharp contraction such as the venturi flume in Fig. P10.113. Show that, for a rectangular section with  $b = b(x)$ , Eq. (10.49) should be modified as follows:

$$\frac{dy}{dx} \approx \frac{S_o - S + [V^2/(gb)](db/dx)}{1 - Fr^2}$$

Investigate a criterion for reducing this relation to Eq. (10.49).

**Solution:** We use the same energy equation, 10.47, but modify continuity, 10.47:

$$\text{Energy: } \frac{dy}{dx} + \frac{V}{g} \frac{dV}{dx} = S_o - S; \quad \text{continuity: } V = \frac{Q}{by}, \quad \therefore \frac{dV}{dx} = -\frac{Q}{by^2} \frac{dy}{dx} - \frac{Q}{yb^2} \frac{db}{dx}$$

$$\text{or: } \frac{dV}{dx} = -\frac{V}{y} \frac{dy}{dx} - \frac{V}{b} \frac{db}{dx}; \quad \text{combine: } \frac{dy}{dx} \left( 1 - \frac{V^2}{gy} \right) \approx S_o - S + \frac{V^2}{gb} \frac{db}{dx} \quad \text{Ans.}$$

Obviously, we can neglect the last term (width expansion) and obtain Eq. 10.49 if

$$\frac{V^2}{gb} \frac{db}{dx} \ll S_o - S = \mathcal{O} \left( \frac{f}{4R_h} \frac{V^2}{2g} \right), \quad \text{or: } \frac{db}{dx} \approx \frac{\Delta b}{L} \ll \frac{f}{8} \frac{b}{R_h} \quad \text{Ans. (approximate)}$$

Since  $(f/8) = \mathcal{O}(0.01)$  and  $(b/R_h) = \mathcal{O}(1)$ , we are OK unless  $\Delta b \approx L$  (large expansion).

**10.116** Investigate the possibility of *frictional effects* in the venturi flume of Prob. 10.113, part (a), for which the frictionless solution is  $Q = 9.88 \text{ m}^3/\text{s}$ . Let the contraction be 3 m long and the measurements of  $y_1$  and  $y_2$  be at positions 3 m upstream and 3 m downstream of the contraction, respectively. Use the modified gradually varied theory of Prob. 10.115, with  $n = 0.018$  to estimate the flow rate.

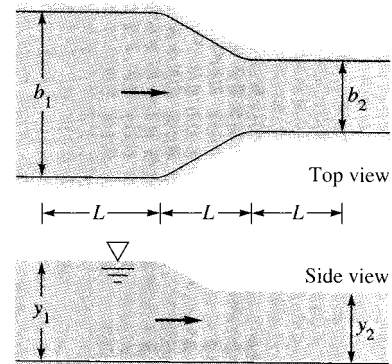


Fig. P10.113

**Solution:** We use the differential equation and assume a smooth contraction:

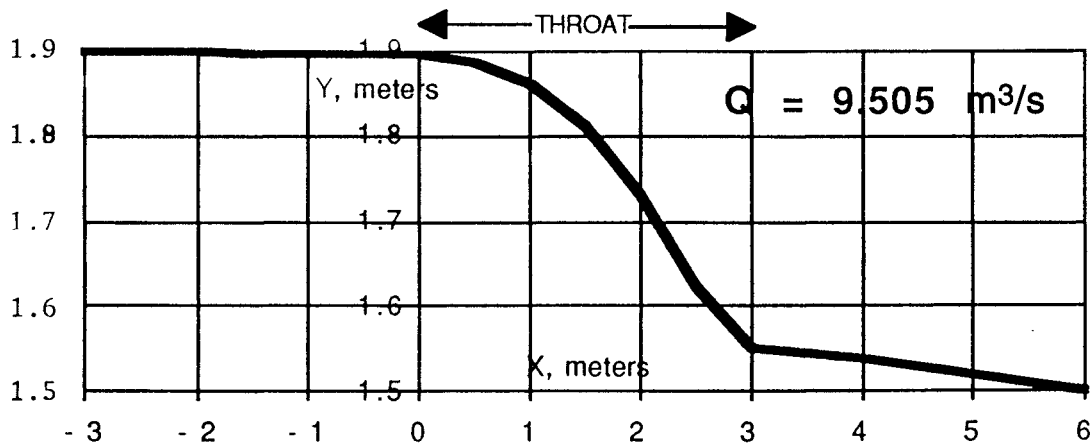
$$\frac{dy}{dx} = \frac{S_o - S + (V^2/gb)(db/dx)}{1 - V^2/(gy)}, \quad S = \frac{n^2 V^2}{R_h^{4/3}}$$

$$\text{and } b \approx b_1 - \frac{b_1 - b_2}{2} \left[ 1 - \cos\left(\frac{\pi x}{L}\right) \right] \text{ in the throat}$$

Assume horizontal ( $S_o = 0$ ) and integrate from  $x = -L$  to  $x = +2L$  where  $L = 3$  m

Note that  $V = Q/(by)$  with  $b = b_1$  for  $-L < x < 0$  and  $b = b_2$  for  $L < x < 2L$ . The given numerical values are  $b_1 = 3$  m,  $b_2 = 2$  m, and  $y(0) = y_1 = 1.9$  m, find  $Q$  if  $y_2 = 1.5$  m. The solution is shown in the graph below. The flow rate is  $Q = 9.505$  m<sup>3</sup>/s. *Ans.*

Here friction causes about a 4% change in the predicted flow rate.



**10.117** A full-width weir in a horizontal channel is 5 m wide and 80 cm high. The upstream depth is 1.5 m. Estimate the flow rate for (a) a sharp-crested weir; and (b) a round-nosed broad-crested weir.

**Solution:** We are given  $b = 5$  m,  $Y = 0.8$  m, and  $H = 1.5 - 0.8 = 0.7$  m. Then

$$C_{d,\text{sharp}} = 0.564 + 0.0846 \left( \frac{0.7}{0.8} \right) \approx 0.638, \quad Q = C_d b \sqrt{g} H^{3/2}$$

$$\text{or: } Q_{\text{sharp}} = 0.638(5.0)\sqrt{9.81}(0.7)^{3/2} \approx 5.85 \text{ m}^3/\text{s} \quad \text{Ans. (a)}$$



For the round-nosed broad-crested weir, we don't know the length or the roughness, so assume it is fairly short and smooth:

$$C_d \approx 0.544; \quad Q_{\text{round,broad}} \approx 0.544(5.0)\sqrt{9.81}(0.7)^{1.5} \approx \mathbf{5.0 \text{ m}^3/\text{s}} \quad \text{Ans. (b)}$$

**10.118** Using a Bernoulli-type analysis similar to Fig. 10.16a, show that the theoretical discharge of the V-shaped weir in Fig. P10.118 is given by

$$Q = 0.7542g^{1/2} \tan \alpha H^{5/2}$$

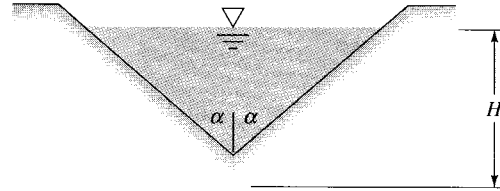


Fig. P10.118

**Solution:** As in Eq. 10.52, assume that velocity  $V$  in any strip of height  $dz$  and width  $b$ , where  $z$  is measured down from the top, is  $V \approx \sqrt{2gz}$  and integrate for the flow rate:

$$Q = \int_{\text{weir}} V dA = \int_0^H \sqrt{2gz} b dz, \quad \text{where } b = b_0(1 - z/H) \quad \text{and } b_0 = \text{top width.}$$

$$\text{Thus } Q = \int_0^H \sqrt{2gz} b_0 \left(1 - \frac{z}{H}\right) dz = \frac{4}{15} \sqrt{2g} \frac{b_0}{H} H^{5/2},$$

$$\text{but from Fig. P10.118 } \frac{b_0}{H} = 2 \tan \alpha$$

$$\text{Finally, then, } Q_{\text{V-notch}} = \frac{8}{15} \sqrt{2g} \tan \alpha H^{5/2} \approx \mathbf{0.7542 \sqrt{g} \tan \alpha H^{5/2}} \quad \text{Ans.}$$

**10.119** Data by A. T. Lenz for water at 20°C (reported in Ref. 19) show a significant increase of discharge coefficient of V-notch weirs (Fig. P10.118) at low heads. For  $\alpha = 20^\circ$ , some measured values are as follows:

$H$ , ft:	0.2	0.4	0.6	0.8	1.0
$C_d$ :	0.499	0.470	0.461	0.456	0.452

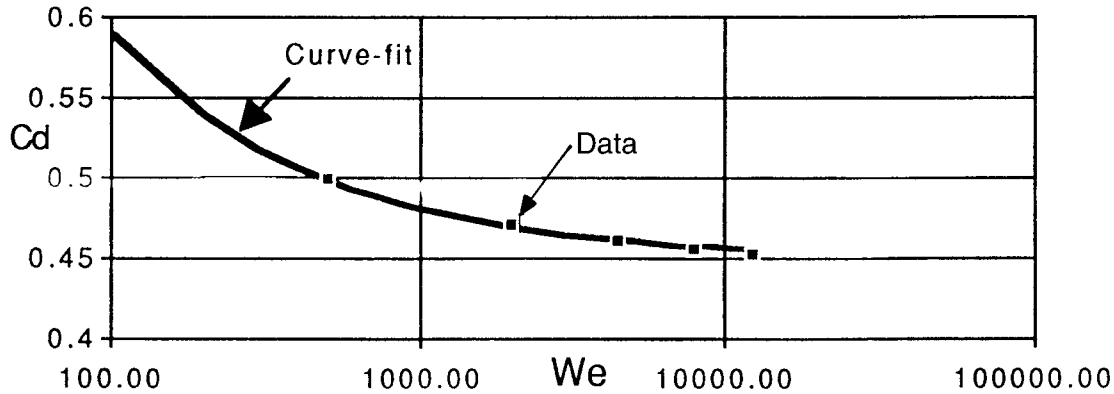
**Solution:** There is little or no Reynolds number effect. We can ascribe the entire effect to surface tension  $Y$ , or Weber number  $We = \rho g H^2 / Y$ .

A Power-law curve-fits the raw data and hence also fits the Weber-number form:

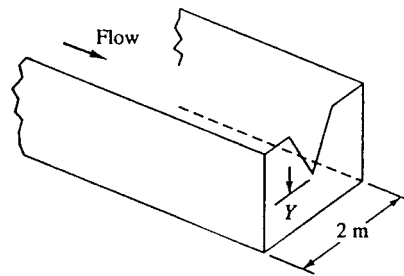
$$C_d = 0.449 + \frac{0.0060}{[H \text{ in ft}]^{1.3}} \pm 0.5\%$$

Convert to dimensionless form:  $C_d \approx 0.449 + \frac{2.8}{We^{0.65}}$ , where  $We = \frac{\rho g H^2}{Y}$  Ans.

The data and this curve-fit are shown on the graph below.



**10.120** The rectangular channel in Fig. P10.120 contains a V-notch weir as shown. The intent is to meter flow rates between  $2.0$  and  $6.0 \text{ m}^3/\text{s}$  with an upstream hook gage set to measure water depths between  $2.0$  and  $2.75 \text{ m}$ . What are the most appropriate values for the notch height  $Y$  and the notch half-angle  $\alpha$ ?



**Fig. P10.120**

**Solution:** There is an *exact* solution to this problem which uses the full range of water depth to measure the full range of flow rates. Of course, there are also a wide variety of combinations of  $(\alpha, Y)$  which do a good job but have somewhat less range and accuracy. Anyway, for the “solution” to this problem, match each flow to each depth, with  $H = y - Y$  and using Table 10.2(c) for the flow-rate correlation:

$$y = 2 \text{ m}: \quad Q = 2 \frac{\text{m}^3}{\text{s}} = 0.44 \tan \alpha \sqrt{g} (2.0 - Y)^{5/2};$$

$$\text{also: } Q = 6 = 0.44 \tan \alpha \sqrt{g} (2.75 - Y)^{5/2}$$

Divide these two to get  $Y \approx 0.64 \text{ m}$  Ans. Back substitute for  $\alpha \approx 34^\circ$  Ans.

**10.121** Water flow in a rectangular channel is to be metered by a thin-plate weir with side contractions, as in Table 10.2b, with  $L = 6$  ft and  $Y = 1$  ft. It is desired to measure flow rates between 1500 and 3000 gal/min with only a 6-in change in upstream water depth. What is the most appropriate length for the weir width  $b$ ?

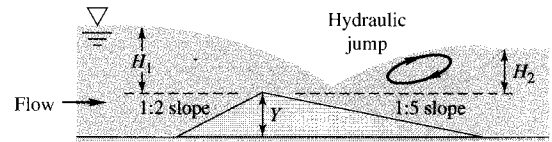
**Solution:** We are given  $Y = 1$  ft, so water level  $y_1$  and weir width  $b$  are the unknowns. Apply Table 10.2(b) to each flow rate, noting that  $y_2 = y_1 + 0.5$  ft:

$$Q_1 = 1500 \text{ gpm} = 3.342 \frac{\text{ft}^3}{\text{s}} = 0.581[b - 0.1(y_1 - 1)]\sqrt{32.2}(y_1 - 1)^{3/2}$$

$$Q_2 = 3000 \text{ gpm} = 6.684 \frac{\text{ft}^3}{\text{s}} = 0.581[b - 0.1(y_1 - 0.5)]\sqrt{32.2}(y_1 - 0.5)^{3/2}$$

Solve simultaneously by iteration for  $y_1 \approx 1.80$  ft and  $\mathbf{b \approx 1.50$  ft} *Ans.*

**10.122** In 1952 E. S Crump developed the triangular weir shape shown in Fig. P10.122 [Ref. 19, chap. 4]. The front slope is 1:2 to avoid sediment deposition, and the rear slope is 1:5 to maintain a stable tailwater flow. The beauty of the design is that it has a unique discharge correlation up to near-drowning conditions,  $H_2/H_1 \leq 0.75$ :



**Fig. P10.122** The Crump weir [19, chap. 4]

$$Q = C_d b g^{1/2} \left( H_1 + \frac{V_1^2}{2g} - k_h \right)^{3/2} \quad \text{where } C_d \approx 0.63 \quad \text{and } k_h \approx 0.3 \text{ mm}$$

The term  $k_h$  is a low-head loss factor. Suppose that the weir is 3 m wide and has a crest height  $Y = 50$  cm. If the water depth upstream is 65 cm, estimate the flow rate in gal/min.

**Solution:** We are given weir height  $Y = 50$  cm and upstream depth  $y_1 = 65$  cm, hence  $H_1 = 65 - 50 = 15$  cm. Apply the formula, which has an unknown (but low) velocity:

$$Q = 0.63(3.0)\sqrt{9.81} \left( 0.15 + \frac{V_1^2}{2(9.81)} - 0.0003 \right)^{3/2}, \quad \text{where } V_1 = \frac{Q}{by_1} = \frac{Q}{3(0.65)}$$

Very slight iteration is needed to find  $Q \approx 0.349 \text{ m}^3/\text{s} \approx \mathbf{5500 \frac{\text{gal}}{\text{min}}}$  *Ans.*

**10.123** The Crump weir in Prob. 10.122 is for *modular* flow, that is, when the flow rate is independent of downstream tailwater. When the weir becomes drowned, the flow rate decreases by the following factor:

$$Q = Q_{\text{modular}} f \quad \text{where } f \approx 1.035 \left[ 0.817 - \left( \frac{H_2^*}{H_1^*} \right)^4 \right]^{0.0647}$$

for  $0.70 \leq H_2^*/H_1^* \leq 0.93$ , where  $H^*$  denotes  $H_1 + V_1^2/(2g) - k_h$  for brevity. The weir is then *double-gaged* to measure both  $H_1$  and  $H_2$ . Suppose that the weir crest is 1 m high and 2 m wide. If the measured upstream and downstream water depths are 2.0 and 1.9 m, respectively, estimate the flow rate in gal/min. Comment on the possible uncertainty of your estimate.

**Solution:** Again, as in Prob. 10.123, we do not know the velocities (which are fairly low) so we have to iterate the formula slightly:

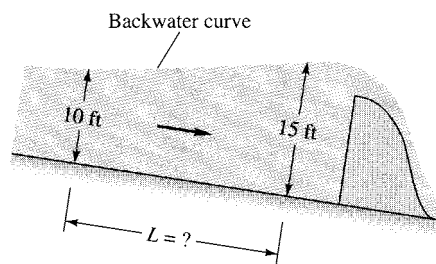
$$Q = 0.63(2.0)\sqrt{9.81} \left( H_2^* \right)^{3/2} f, \quad \text{where } H^* = H + \frac{V^2}{2g} - k_h, \quad V = \frac{Q}{by} \text{ for both 1 and 2}$$

Given  $H_1 = 2 - 1 = 1$  m and  $H_2 = 1.9 - 1 = 0.9$  m, iterate slightly to

$$Q \approx 3.84 \text{ m}^3/\text{s} \approx \mathbf{61000 \text{ gal/min}} \quad \text{Ans.}$$

This estimate is uncertain to at least  $\pm 5\%$ . The formula itself is a curve-fit and therefore probably uncertain. In addition, the formula is very sensitive to the measured values of  $y_1$  and  $y_2$ . For example, a **1%** error in these measurements causes a **10%** change in  $Q$ . *Ans.*

**10.124** Water flows at  $600 \text{ ft}^3/\text{s}$  in a rectangular channel 22 ft wide with  $n \approx 0.024$  and a slope of  $0.1^\circ$ . A dam increases the depth to 15 ft, as in Fig. P10.124. Using gradually varied theory, estimate the distance  $L$  upstream at which the water depth will be 10 ft. What type of solution curve are we on? What should be the water depth asymptotically far upstream?



**Fig. P10.124**

**Solution:** With depth given just upstream of the dam, we do not have to make a “weir” calculation, but instead go directly to the gradually-varied-flow calculation. Note first that

$$Q = 600 = \frac{1.486}{0.024} (22y_n) \left( \frac{22y_n}{22 + 2y_n} \right)^{2/3} (\sin 0.1^\circ)^{1/2}, \quad \text{solve for normal depth } y_n \approx 4.74$$

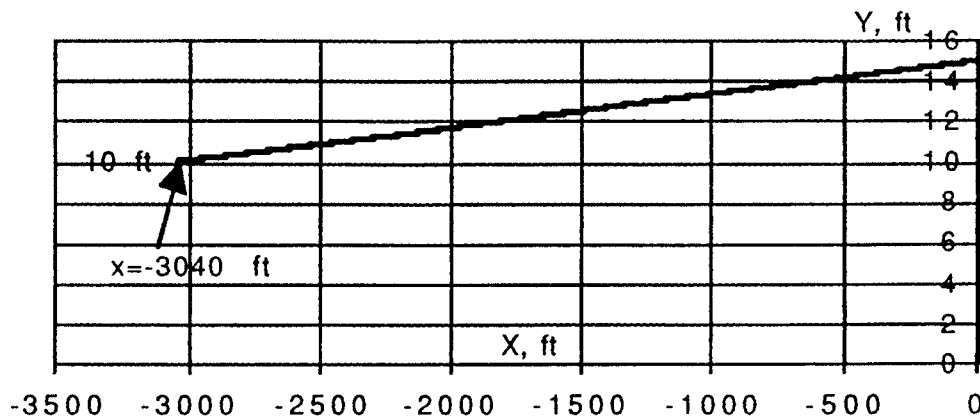
$$\text{Also, } y_c = (q^2/g)^{1/3} = \left[ \frac{(600/22)^2}{32.2} \right]^{1/3} \quad \text{or critical depth } y_c \approx 2.85$$

Therefore, since  $y_c < y_n < y$ , we are on a mild-slope **M-1 curve**. *Ans.* (Fig. 10.4c) The basic differential equation is:

$$\frac{dy}{dx} = \frac{S_o - n^2 q^2 / (2.208 y^2 R_h^{4/3})}{1 - q^2 / (g y^3)},$$

$$\text{where } q = \frac{600}{22}, \quad R_h = \frac{22y}{22 + 2y}, \quad n = 0.024, \quad S_o = \sin 0.1^\circ$$

The graph of  $y(x)$  is shown below. We reach  $y = 10$  ft at  $x = -3040$  ft. *Ans.*  
If we keep integrating backward, we reach  $v = v_n \approx 4.74$  ft.



**10.125** The Tupperware dam on the Blackstone River is 12 ft high, 100 ft wide, and sharp-edged. It creates a backwater similar to Fig. P10.124. Assume that the river is a weedy-earth rectangular channel 100 ft wide with a flow rate of  $800 \text{ ft}^3/\text{s}$ . Estimate the water-depth 2 mi upstream of the dam if  $S_o = 0.001$ .

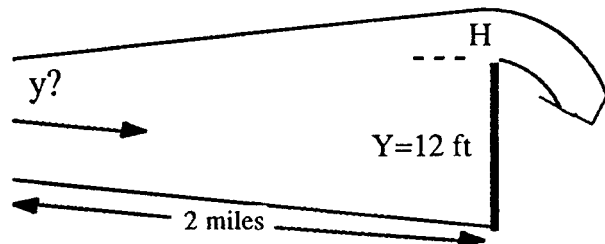


Fig. P10.125

**Solution:** First use the weir formula to establish the water depth just upstream of the dam:

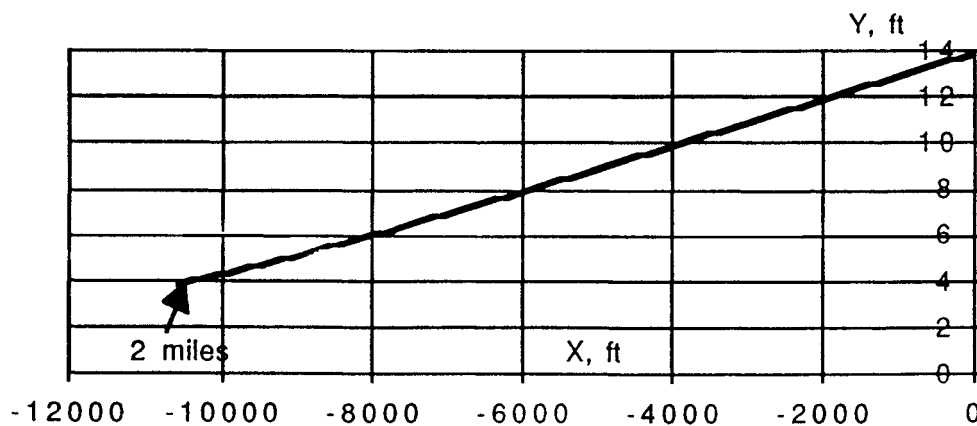
$$Q = 800 \frac{\text{ft}^3}{\text{s}} = C_d b \sqrt{g} H^{3/2} = \left(0.564 + 0.0846 \frac{H}{Y}\right) (100) \sqrt{32.2} H^{3/2},$$

Solve for  $H \approx 1.81$  ft

Therefore the initial water depth is  $y(0) = Y + H = 12 + 1.81 = 13.81$  ft. For weedy earth, take  $n \approx 0.030$ . We are on an **M-1 curve**, with a basic differential equation

$$\frac{dy}{dx} = \frac{S_o - n^2 q^2 / (2.208 y^2 R_h^{4/3})}{1 - q^2 / (g y^3)}, \quad \text{where } q = \frac{800}{100}, R_h = \frac{100y}{100 + 2y}, n = 0.030, S_o = 0.001$$

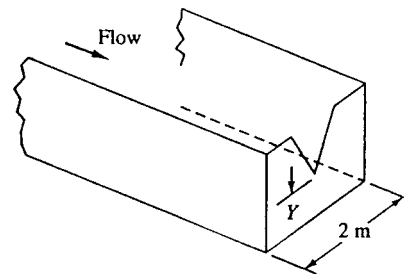
to be integrated backwards ( $\Delta x < 0$ ) for 2 miles (10560 ft). The result is shown in the graph below.



At  $x = -2$  miles  $= -10560$  ft, the water depth is  $y \approx 3.8$  ft. *Ans.*

[Another mile upstream and we would asymptotically reach the normal depth of 2.71 ft.]

**10.126** Suppose that the rectangular channel of Fig. P10.120 is made of riveted steel with a flow of  $8 \text{ m}^3/\text{s}$ . If  $\alpha = 30^\circ$  and  $Y = 50$  cm, estimate, from gradually-varied theory, the water depth 100 meters upstream.



**Fig. P10.120**

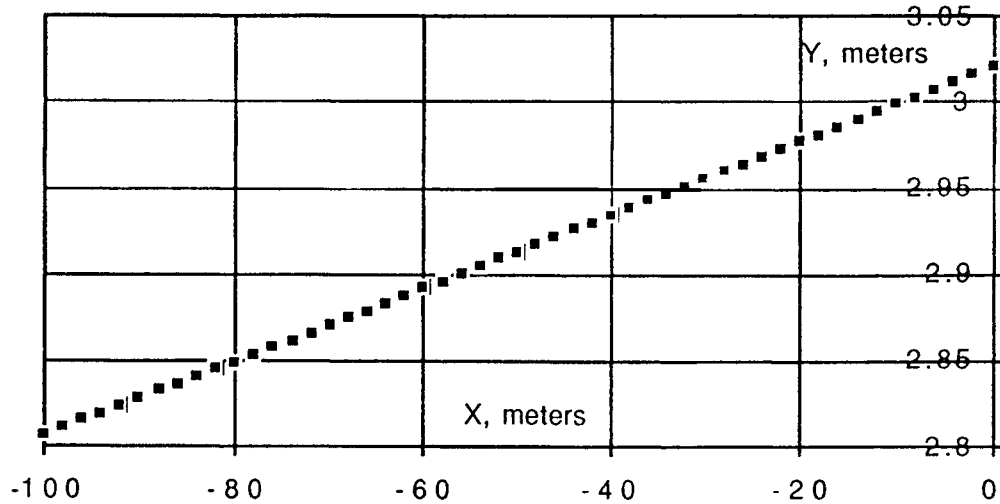
**Solution:** For riveted steel, take  $n \approx 0.015$ . First use the weir formula to get  $y(0)$ :

$$Q = 8 \frac{\text{m}^3}{\text{s}} = 0.44 \tan 30^\circ \sqrt{9.81} H^{5/2}, \quad \text{solve } H \approx 2.52 \text{ m}, y(0) = 2.52 + 0.5 = 3.02 \text{ m}$$

The basic differential equation is

$$\frac{dy}{dx} = \frac{S_o - n^2 q^2 / (y^2 R_h^{4/3})}{1 - q^2 / (gy^3)}, \quad \text{where } q = \frac{8}{2}, R_h = \frac{2y}{2+2y}, n = 0.015, S_o = \sin 0.15^\circ$$

Integrate backwards ( $\Delta x < 0$ ) for 100 m. The result is shown in the graph below:



At  $x = -100$  m, the water depth is  $y \approx 2.81$  m. *Ans.*

[Another 1000 m upstream and we asymptotically reach the normal depth of 1.62 m.]

**10.127** A horizontal gravelly earth channel 2 m wide contains a full-width Crump weir (Fig. P10.122) 1 m high. If the weir is not drowned, estimate, from gradually varied theory, the flow rate for which the water depth 100 m upstream will be 2 m.

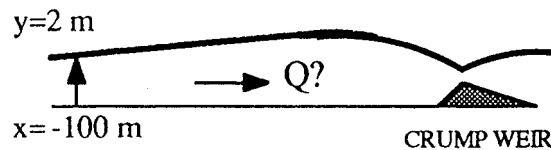


Fig. P10.127

**Solution:** With  $Q$  unknown, we need to *combine* weir and gradually-varied theories:

$$Q_{\text{Crump}} = 0.63(2.0)\sqrt{9.81} \left( H + \frac{V^2}{2g} - 0.0003 \text{ m} \right)^{3/2}, \quad V = \frac{Q}{(2.0)y_o}$$

$$\frac{dy}{dx} = \frac{S_o - n^2 q^2 / (y^2 R_h^{4/3})}{1 - q^2 / (gy^3)}, \quad \text{where } q = \frac{Q}{2.0}, R_h = \frac{2y}{2+2y}, S_o = 0, n_{\text{gravelly}} \approx 0.025$$

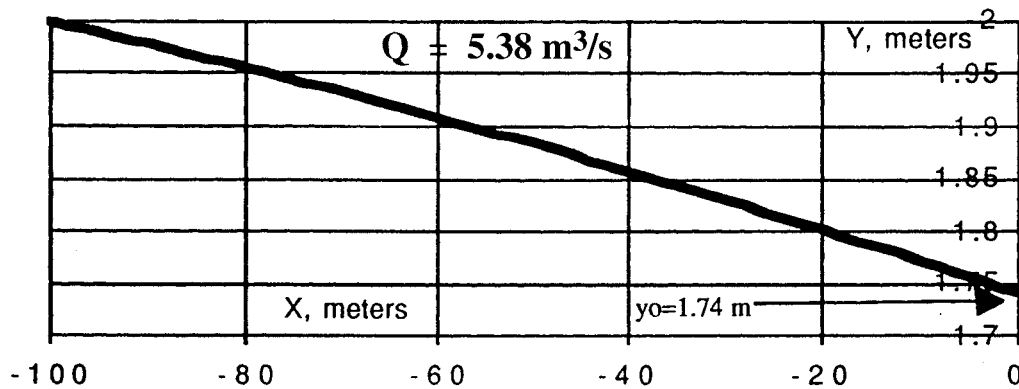
With  $Q$  and  $H$  unknown, guess  $Q$ , find  $H$ ,  $y(0) = Y + H = 0.5 \text{ m} + H$ , then integrate backwards along the “backwater” curve to  $x = -100 \text{ m}$ , see if water depth there is  $2 \text{ m}$ .

A list of such guesses is given as follows, after *much* digital computation:

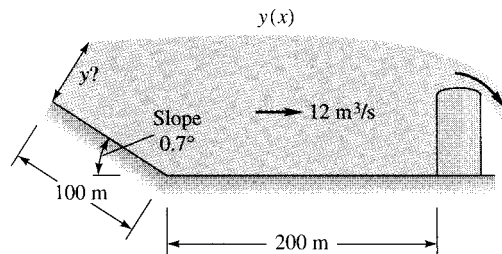
$Q, \text{ m}^3/\text{s}:$	1.0	2.0	3.0	4.0	5.0	<b>5.38</b>
$H, \text{ m}:$	0.230	0.451	0.678	0.912	1.150	1.242
$y(\text{at } -100 \text{ m}), \text{ m}:$	0.814	1.111	1.385	1.648	1.904	<b>2.000</b>

After iteration, the proper flow rate is  $Q \approx 5.38 \text{ m}^3/\text{s}$ . *Ans.*

[This gives  $H \approx 1.24 \text{ m}$  and  $y(0) \approx 1.74 \text{ m}$ .]



**10.128** A rectangular channel 4 m wide is blocked by a broadcrested weir 2 m high, as in Fig. P10.128. The channel is horizontal for 200 m upstream and then slopes at  $0.7^\circ$  as shown. The flow rate is  $12 \text{ m}^3/\text{s}$ , and  $n = 0.03$ . Compute the water depth  $y$  at 300 m upstream from gradually varied theory.



**Fig. P10.128**

**Solution:** First use (smooth) weir theory to establish the depth just upstream of the dam:

$$Q = 12 \frac{\text{m}^3}{\text{s}} \approx 0.544(4.0)\sqrt{9.81}H^{3/2}, \quad \text{solve for } H \approx 1.46 \text{ m}, \quad \therefore y(0) = H + Y = 3.46 \text{ m}$$

$$\frac{dy}{dx} = \frac{S_o - n^2 q^2 / (y^2 R_h^{4/3})}{1 - q^2 / (gy^3)}, \quad \text{where } q = \frac{12}{4}, \quad R_h = \frac{4y}{4 + 2y}, \quad n = 0.03, \quad \text{two values of } S_o$$



Integrate backwards ( $\Delta x < 0$ ) for 200 m with  $S_o = 0$ , then for 100 m with  $S_o = \sin 0.7^\circ$ . After 200 m, the depth is  $y = 3.56$  m. Then at  $x = -300$  m,  $y \approx \mathbf{2.37}$  m. *Ans.*

Both water profiles are nearly linear:

x, m:	0	-50	-100	-150	-200	-225	-250	-275	-300
y, m:	3.46	3.49	3.51	3.53	3.56	3.26	2.96	2.66	<b><u>2.37 m</u></b>

[At  $x \approx -400$  m, the sloped flow will approach its normal depth of 1.05 m.]

---

**FUNDAMENTALS OF ENGINEERING EXAM PROBLEMS: Answers**

FE10.1 Consider a rectangular channel 3 m wide laid on a  $1^\circ$  slope. If the water depth is 2 m, the hydraulic radius is

- (a) 0.43 m (b) 0.6 m (c) **0.86 m** (d) 1.0 m (e) 1.2 m

FE10.2 For the channel of Prob. FE10.1, the most efficient water depth (best flow for a given slope and resistance) is

- (a) 1 m (b) **1.5 m** (c) 2 m (d) 2.5 m (e) 3 m

FE10.3 If the channel of Prob. FE10.1 is built of rubble cement (Manning's  $n \approx 0.020$ ), what is the uniform flow rate when the water depth is 2 m?

- (a)  $6 \text{ m}^3/\text{s}$  (b)  $18 \text{ m}^3/\text{s}$  (c)  **$36 \text{ m}^3/\text{s}$**  (d)  $40 \text{ m}^3/\text{s}$  (e)  $53 \text{ m}^3/\text{s}$

FE10.4 For the channel of Prob. FE10.1, if the water depth is 2 m and the uniform flow rate is  $24 \text{ m}^3/\text{s}$ , what is the approximate value of Manning's roughness factor  $n$ ?

- (a) 0.015 (b) 0.020 (c) 0.025 (d) **0.030** (e) 0.035

FE10.5 For the channel of Prob. FE10.1, if Manning's roughness factor  $n \approx 0.020$  and  $Q \approx 24 \text{ m}^3/\text{s}$ , what is the normal depth  $y_n$ ?

- (a) 1 m (b) **1.5 m** (c) 2 m (d) 2.5 m (e) 3 m

FE10.6 For the channel of Prob. FE10.1, if  $Q \approx 24 \text{ m}^3/\text{s}$ , what is the critical depth  $y_c$ ?

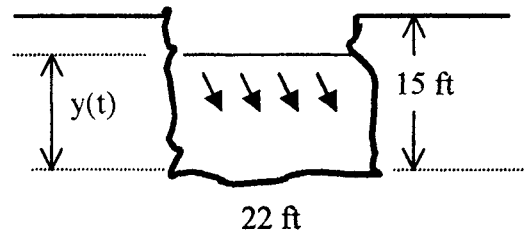
- (a) 1.0 m (b) 1.26 m (c) 1.5 m (d) **1.87 m** (e) 2.0 m

FE10.7 For the channel of Prob. FE10.1, if  $Q \approx 24 \text{ m}^3/\text{s}$  and the depth is 2 m, what is the Froude number of the flow?

- (a) 0.50 (b) 0.77 (c) **0.90** (d) 1.00 (e) 1.11

## COMPREHENSIVE APPLIED PROBLEMS

**C10.1** February 1998 saw the failure of the earthen dam impounding California Jim's Pond in southern Rhode Island. The resulting flood raised temporary havoc in the nearby village of Peace Dale. The pond is 17 acres in area and 15 ft deep and was full from heavy rains. The breach in the dam was 22 ft wide and 15 ft deep. Estimate the time required to drain the pond to a depth of 2 ft.



**Solution:** Unfortunately, Table 10.2, item  $b$ , does not really apply, because the breach is so *deep*:  $H = y > 0.5Y = 0$ . Nevertheless, it's all we have, and ponds don't rupture every day, so let's use it! A control volume around the pond yields

$$\frac{d}{dt} \left( \int d v_{pond} \right) + Q_{out} = 0,$$

$$\text{or: } A_{pond} \frac{dy}{dt} = -Q_{out} = -0.581(b - 0.1y)g^{1/2}y^{3/2},$$

$$b = 22 \text{ ft}, \quad A_{pond} = 17 \text{ acres} = 740,520 \text{ ft}^2$$

If we neglect the "edge contraction" term " $-0.1y$ " compared to  $b = 22$  ft, this first-order differential equation has the solvable form

$$\frac{dy}{dt} \approx -Cy^{3/2}, \quad \text{where } C = \frac{0.581(22 \text{ ft})(32.2)^{1/2}}{740520} \approx 9.8\text{E-}5 \text{ ft}^{-1/2}\text{sec}^{-1}$$

$$\text{Separate and integrate: } \int_{15 \text{ ft}}^{2 \text{ ft}} \frac{dy}{y^{3/2}} = -C \int_0^t dt, \quad \text{or: } \frac{2}{\sqrt{2}} - \frac{2}{\sqrt{15}} = Ct$$

$$\text{Finally, solve } t_{\text{drain-to-2 ft}} \approx \frac{1.414 - 0.516}{9.8\text{E-}5} = 9160 \text{ s} = \mathbf{2.55 \text{ h}} \quad \text{Ans.}$$

If we used a spreadsheet and kept the term " $-0.1y$ ", we would predict a *time-to-drain-to-2 ft* or about **2.61** hours. The theory is too crude to distinguish between these estimates.

**C10.2** A circular, unfinished concrete drainpipe is laid on a slope of 0.0025 and is planned to carry from 50 to 300 ft<sup>3</sup>/s of run-off water. Design constraints are that (1) the water depth should be no more than 3/4 of the diameter; and (2) the flow should always be subcritical. What is the appropriate pipe diameter to satisfy these requirements? If no commercial pipe is exactly this calculated size, should you buy the next smallest or the next largest pipe?

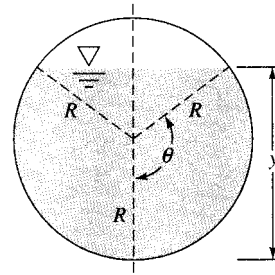


Fig. C10.2

**Solution:** For unfinished concrete  $n \approx 0.014$ . From the geometry of Fig. 10.6, 3/4-full corresponds to an angle  $\theta = 120^\circ$ . This level should be able to carry the maximum 300 ft<sup>3</sup>/s flow:

$$\theta = 120^\circ: \quad A = R^2 \left( \theta - \frac{\sin 2\theta}{2} \right) = 2.53R^2; \quad R_h = \frac{R}{2} \left( 1 - \frac{\sin 2\theta}{2} \right) = 0.603R$$

$$\text{Try } Q = 300 \frac{\text{ft}^3}{\text{s}} = \frac{1.49}{n} A R_h^{2/3} S_o^{1/2} = \frac{1.49}{0.014} (2.53R^2)(0.603R)^{2/3} \sqrt{0.0025}$$

$$\text{Solve for } R_{3/4\text{-full}} \approx \mathbf{3.64 \text{ ft}} \quad \text{Ans.}$$

Now check to see if this flow is subcritical:

$$A_c = \left( \frac{b_0 Q^2}{g} \right)^{1/3} = \left[ \frac{(1.732)(3.64)(Q_c)^2}{32.2} \right]^{1/3} = 2.53(3.64)^2$$

$$\text{Solve for } Q_c = 438 \frac{\text{ft}^3}{\text{s}} > 300, \quad \therefore \text{flow is subcritical}$$

Even at max flow, three-quarters full, the Froude number is only 0.68. Scanning the other flow rates, down to 50 ft<sup>3</sup>/s, yields *smaller* drainpipes. Therefore we conclude that a pipe of diameter  $\mathbf{D} \approx \mathbf{7.3 \text{ ft}}$  will do the job. Pick the nearest *larger* available size. *Ans.*

**C10.3** Extend Prob. 10.72, whose solution was  $V_2 = 4.33 \text{ m/s}$ . Use gradually-varied theory to estimate the water depth 10 m down at section 3 for (a) the 5° unfinished concrete slope shown in the figure; and (b) for an *upward* (−5°) adverse slope. (c) When you find out that (b) is *impossible*, explain why and repeat for an adverse slope of (−1°).

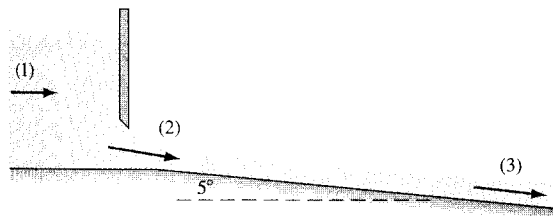


Fig. P10.72

**Solution:** For unfinished concrete take  $n \approx 0.014$ . Note that  $y(0) = 0.0462$  m. For the given flow rate  $q = 0.2$  m<sup>3</sup>/s·m, first calculate reference depths:

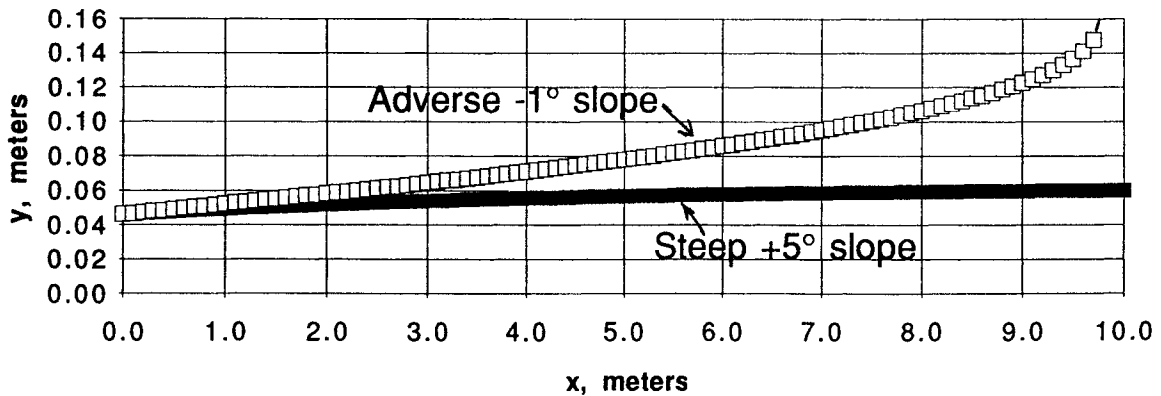
$$q = 0.2 = \frac{1}{0.014} (y)(y^{2/3})\sqrt{\sin 5^\circ}, \quad \text{solve normal depth } y_n \approx 0.0611 \text{ m}$$

$$\text{Critical depth: } y_c = \left(\frac{q^2}{g}\right)^{1/3} = \left(\frac{0.2^2}{9.81}\right)^{1/3} = 0.160 \text{ m} \quad \therefore \text{Steep S-3 curve.}$$

The channel is “wide,” so the formulation of Example 10.8 is appropriate:

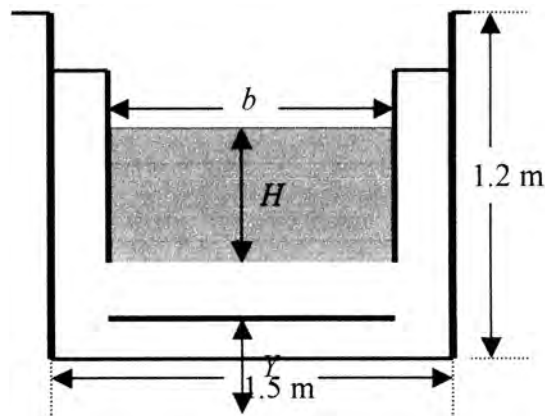
$$\frac{dy}{dx} = \frac{S_0 - n^2 q^2 / y^{10/3}}{1 - q^2 / (gy^3)}, \quad S_0 = \sin \pm 5^\circ, \quad n = 0.014, \quad q = 0.2, \quad y(0) = 0.0462 \text{ m}, \quad y(10 \text{ m}) = ?$$

Numerical integration, by Excel or MATLAB or whatever, for the *steep (S-3)* slope yields  $y = 0.060$  m at  $x = 10$  m, nearly critical, as shown below. *Ans.* (a) Integration for the adverse ( $-5^\circ$ ) slope goes to *critical* at about  $x = 4.5$  m—the theory fails for  $x > 4.5$  m. *Ans.* (b) If we go back and take a *smaller* adverse slope of ( $-1^\circ$ ), we obtain  $y \approx 0.16$  m at  $x = 9.8$  m—the flow goes critical near  $x = L$ , as shown in the graph below. *Ans.* (c)



**C10.4** It is desired to meter an asphalt rectangular channel of width 1.5 m which is designed for uniform flow at a depth of 70 cm and a slope of 0.0036. The vertical sides of the channel are 1.2 m high. Consider using a thin-plate rectangular weir, either full or partial width (Table 10.2a, b) for this purpose. Sturm [7, p. 51] recommends, for accurate correlation, that such a weir have  $Y \geq 9$  cm and  $H/Y \leq 2.0$ . Determine the feasibility of installing such a weir which will be accurate and yet not cause the water to overflow the sides of the channel.

**Solution:** For asphalt take  $n = 0.016$ . We have only one partial-width formula, and that is from Table 10.2b. We are slightly outside the limits of applicability, but we will use it anyway:



$$Q_{weir} = 0.581(b - 0.1H)g^{1/2}H^{3/2}$$

where  $b$  and  $H$  are shown in the figure.

Meanwhile, calculate the total flow rate in the expected normal flow:

$$Q = \frac{1}{n} AR_h^{2/3} \sqrt{S_o} = \frac{1}{0.016} [1.5 \text{ m}(0.7 \text{ m})] \left[ \frac{1.5 \text{ m}(0.7 \text{ m})}{1.5 \text{ m} + 2(0.7 \text{ m})} \right]^{2/3} \sqrt{0.0036} = 2.00 \frac{\text{m}^3}{\text{s}}$$

The weir discharge must equal this flow rate. Let us begin by making  $b$  equal to the full available width of 1.5 m and holding  $Y$  to the minimum height of 9 cm. The weir formula is:

$$Q = 2.0 \frac{\text{m}^3}{\text{s}} = 0.581(1.5 \text{ m} - 0.1H)(9.81 \text{ m/s}^2)^{1/2} H^{3/2}, \quad \text{solve for } H = 0.845 \text{ m}$$

Note that  $H$  is independent of  $Y$ , but the ratio  $H/Y = 0.845/0.09 = 9.4$ , which far exceeds: Sturm's recommendation  $H/Y \leq 2.0$ . If we raise  $Y$  to  $H/2 = 0.423 \text{ m}$ , the total upstream water depth is  $H + Y = 1.27 \text{ m}$ , which overflows the channel walls. If we back down to  $Y = 0.35 \text{ m}$ , the upstream depth is only 1.195 m, so **a wide-weir design is possible with  $H/Y = 2.4$ , not bad.**

Similarly, we can try shorter values of  $b$ , but either (1) the upstream depth will exceed 1.2 m, or (2) the ratio  $H/Y$  will exceed 2.0. Here are some possible scenarios:

$$\begin{aligned} b = 1.4 \text{ m: } & H = 0.89 \text{ m}; H + Y \approx 1.2 \text{ m} \quad \text{if } Y = 0.31 \text{ m} \quad \text{and } H/Y = 2.9 \\ b = 1.25 \text{ m: } & H = 0.97 \text{ m}; H + Y \approx 1.2 \text{ m} \quad \text{if } Y = 0.23 \text{ m} \quad \text{and } H/Y = 4.2 \\ b = 1.0 \text{ m: } & H = 1.16 \text{ m}; H + Y \approx 1.2 \text{ m} \quad \text{if } Y = 0.04 \text{ m} \quad \text{and } H/Y = 29.0 \end{aligned}$$

The first two of these are plausible, although  $H/Y$  is larger than 2.0. The third result is not recommended because  $Y$  is too far below 9 cm. **We conclude that reasonable designs are possible, but they slightly violate the constraints on the formulas we are using.**

**C10.5** Figure C10.5 shows a hydraulic model of a *compound weir*, that is, one which combines two different shapes. (a) Other than measurement, for which it might be useful, what could be the engineering reason for such a weir? (b) For the prototype river, assume that both sections have sides at a  $70^\circ$  angle to the vertical, with the bottom section having a base width of 2 m and the upper section having a base width of 4.5 m, including the cut-out portion. The heights of lower and upper horizontal sections are 1 m and 2 m, respectively. Use engineering estimates and make a plot of upstream water depth versus Petaluma River flow rate in the range 0 to  $4 \text{ m}^3/\text{s}$ . (c) For what river flow rate will the water overflow the top of the dam?

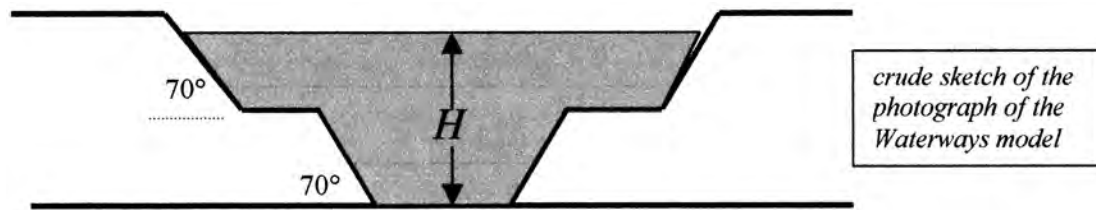


Fig. C10.5

**Solution:** We have no formulas in the text for a compound weir shape, but we can still use the concept of weir flow and estimate the discharge for various water depths.

(a) A good reason for using a narrow bottom portion of the weir is to maintain a reasonable upstream depth at low flow, then widen to maintain a lower depth at high flow. It also allows a more accurate flow measurement during low flow. *Ans. (a)*

(b) Rather than derive a whole new theory for compound weirs, we will assume that the bottom portion is more or less rectangular, based on average width  $b$ , with the top portion also assumed rectangular with its flow rate added onto the lower portion. For example, if  $H = 1 \text{ m}$  (the top of the lower portion), the flow rate is estimated by Table 10.2b:

$$b_{avg} = \frac{2.728 + 2.0 \text{ m}}{2} = 2.364 \text{ m}, \quad Q \approx 0.58(b_{avg} - 0.1H)g^{1/2}H^{3/2}$$

$$\text{or: } Q_{lower} = 0.58[2.364 \text{ m} - 0.1(1 \text{ m})](9.81 \text{ m/s}^2)^{1/2}(1 \text{ m})^{3/2} \approx 4.1 \text{ m}^3/\text{s}$$

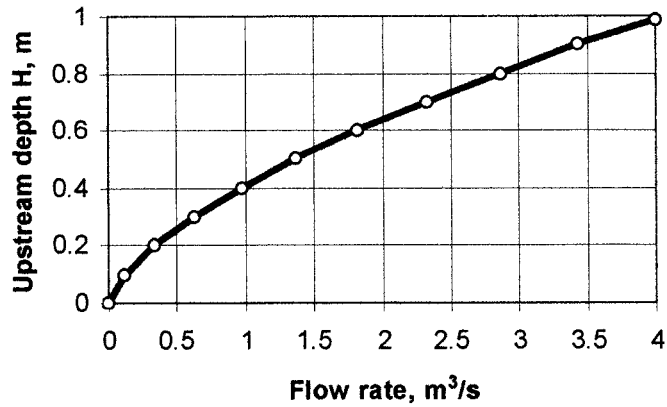
Then if  $H = 2 \text{ m} > 1 \text{ m}$ , we figure  $Q_{upper}$  the same way and add on the lower portion flow. Again take  $H = 1 \text{ m}$ , that is, the height of the flow above the lower part of the weir:

$$b_{avg} = \frac{4.5 + 5.23 \text{ m}}{2} = 4.87 \text{ m}, \quad Q \approx 0.58(b_{avg} - 0.1H)g^{1/2}H^{3/2}$$

or:  $Q_{upper} = 0.58[4.87 \text{ m} - 0.1(1 \text{ m})](9.81 \text{ m/s}^2)^{1/2} (1 \text{ m})^{3/2} \approx 8.7 \text{ m}^3/\text{s}$

Thus  $Q_{total} = Q_{lower} + Q_{upper} = 4.1 + 8.7 \approx 12.8 \text{ m}^3/\text{s}$

Flow rates greater than this value of  $12.8 \text{ m}^3/\text{s}$  will **overflow the top of the weir**. *Ans. (b)*  
A plot of  $Q$  versus  $H$  for the range  $0 < Q < 4 \text{ m}^3/\text{s}$  is shown below.



Problem C10.5

---



# Chapter 11 • Turbomachinery

**11.1** Describe the geometry and operation of a human peristaltic PDP which is cherished by every romantic person on earth. How do the two ventricles differ?

**Solution:** Clearly we are speaking of the *human heart*, driven periodically by travelling compression of the heart walls. One ventricle serves the brain and the rest of one's extremities, while the other ventricle serves the lungs and promotes oxygenation of the blood. *Ans.*

---

**11.2** What would be the technical classification of the following turbomachines:

- (a) a household fan = **an axial flow fan**. *Ans.* (a)
  - (b) a windmill = **an axial flow turbine**. *Ans.* (b)
  - (c) an aircraft propeller = **an axial flow fan**. *Ans.* (c)
  - (d) a fuel pump in a car = **a positive displacement pump (PDP)**. *Ans.* (d)
  - (e) an eductor = **a liquid-jet-pump** (special purpose). *Ans.* (e)
  - (f) a fluid coupling transmission = **a double-impeller energy transmission device**. *Ans.* (f)
  - (g) a power plant steam turbine = **an axial flow turbine**. *Ans.* (g)
- 

**11.3** A PDP can deliver almost any fluid, but there is always a limiting very-high *viscosity* for which performance will deteriorate. Can you explain the probable reason?

**Solution:** High-viscosity fluids take a long time to enter and fill the inlet cavity of a PDP. Thus a PDP pumping high-viscosity liquid should be run slowly to ensure filling. *Ans.*

---

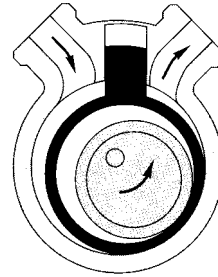
**11.4** An interesting turbomachine is the *torque converter* [58], which combines both a pump and a turbine to change torque between two shafts. Do some research on this concept and describe it, with a report, sketches and performance data, to the class.

**Solution:** As described, for example, in Ref. 58, the torque converter transfers torque  $T$  from a pump runner to a turbine runner such that  $\omega_{\text{pump}} T_{\text{pump}} \approx \omega_{\text{turbine}} T_{\text{turbine}}$ . Maximum efficiency occurs when the turbine speed  $\omega_{\text{turbine}}$  is approximately one-half of the pump speed  $\omega_{\text{pump}}$ . *Ans.*

---

**11.5** What type of pump is shown in Fig. P11.5? How does it operate?

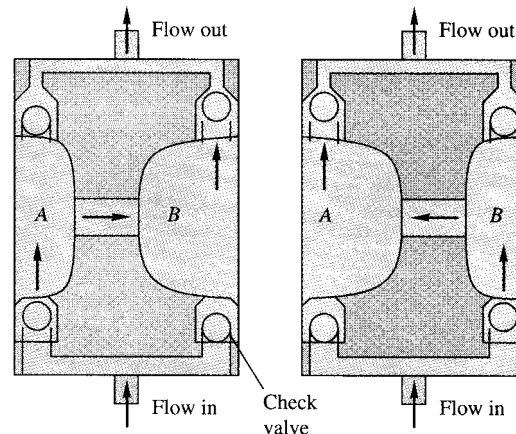
**Solution:** This is a *flexible-liner* pump. The rotating eccentric cylinder acts as a “squeegee.” *Ans.*



**Fig. P11.5**

**11.6** Fig. P11.6 shows two points a half-period apart in the operation of a pump. What type of pump is this? How does it work? Sketch your best guess of flow rate versus time for a few cycles.

**Solution:** This is a **diaphragm** pump. As the center rod moves to the right, opening A and closing B, the check valves allow A to fill and B to discharge. Then, when the rod moves to the left, B fills and A discharges. Depending upon the exact oscillatory motion of the center rod, the flow rate is fairly steady, being higher when the rod is faster. *Ans.*



**Fig. P11.6**

**11.7** A piston PDP has a 5-in diameter and a 2-in stroke and operates at 750 rpm with 92% volumetric efficiency. (a) What is the delivery, in gal/min? (b) If the pump delivers SAE 10W oil at 20°C against a head of 50 ft, what horsepower is required when the overall efficiency is 84%?

**Solution:** For SAE 10W oil, take  $\rho \approx 870 \text{ kg/m}^3 \approx 1.69 \text{ slug/ft}^3$ . The volume displaced is

$$v = \frac{\pi}{4} (5)^2 (2) = 39.3 \text{ in}^3,$$

$$\therefore Q = \left( 39.3 \frac{\text{in}^3}{\text{stroke}} \right) \left( \frac{1 \text{ gal}}{231 \text{ in}^3} \right) \left( 750 \frac{\text{strokes}}{\text{min}} \right) (0.92 \text{ efficiency})$$

$$\text{or: } Q \approx \mathbf{117 \text{ gal/min}} \quad \text{Ans. (a)}$$

$$\text{Power} = \frac{\rho g Q H}{\eta} = \frac{1.69(32.2) \left( \frac{117}{449} \text{ ft}^3/\text{s} \right) (50)}{0.84} = 846 \frac{\text{ft} \cdot \text{lbf}}{\text{s}} \div 550 \approx \mathbf{1.54 \text{ hp}} \quad \text{Ans. (b)}$$


---

**11.8** A centrifugal pump delivers 550 gal/min of water at 20°C when the brake horsepower is 22 and the efficiency is 71%. (a) Estimate the head rise in ft and the pressure rise in psi. (b) Also estimate the head rise and horsepower if instead the delivery is 550 gal/min of gasoline at 20°C.

**Solution:** (a) For water at 20°C, take  $\rho \approx 998 \text{ kg/m}^3 \approx 1.94 \text{ slug/ft}^3$ . The power relation is

$$\text{Power} = 22(550) = 12100 \frac{\text{ft} \cdot \text{lbf}}{\text{s}} = \frac{\rho g Q H}{\eta} = \frac{(62.4) \left( \frac{550}{449} \frac{\text{ft}^3}{\text{s}} \right) H}{0.71},$$

$$\text{or } H \approx \mathbf{112 \text{ ft}} \quad \text{Ans. (a)}$$

$$\text{Pressure rise } \Delta p = \rho g H = (62.4)(112) = 7011 \text{ psf} \div 144 \approx \mathbf{49 \text{ psi}} \quad \text{Ans. (a)}$$

(b) For gasoline at 20°C, take  $\rho \approx 680 \text{ kg/m}^3 \approx 1.32 \text{ slug/ft}^3$ . If viscosity (Reynolds number) is not important, the operating conditions (flow rate, impeller size and speed) are exactly the same and hence the head is the same and the power scales with the density:

$$H \approx \mathbf{112 \text{ ft}} \text{ (of gasoline); } \text{Power} = P_{\text{water}} \frac{\rho_{\text{gasoline}}}{\rho_{\text{water}}} = 22 \left( \frac{680}{998} \right) \approx \mathbf{15 \text{ hp}} \quad \text{Ans. (b)}$$


---

**11.9** Figure P11.9 shows the measured performance of the Vickers Inc. Model PVQ40 piston pump when delivering SAE 10W oil at 180°F ( $\rho \approx 910 \text{ kg/m}^3$ ). Make some general observations about these data vis-à-vis Fig. 11.2 and your intuition about PDP behavior.

**Solution:** The following are observed:

- The discharge  $Q$  is almost linearly proportional to speed  $\Omega$  and slightly less for the higher heads ( $H$  or  $\Delta p$ ).
- The efficiency (volumetric or overall) is nearly independent of speed  $\Omega$  and again slightly less for high  $\Delta p$ .
- The power required is linearly proportional to the speed  $\Omega$  and also to the head  $H$  (or  $\Delta p$ ). *Ans.*

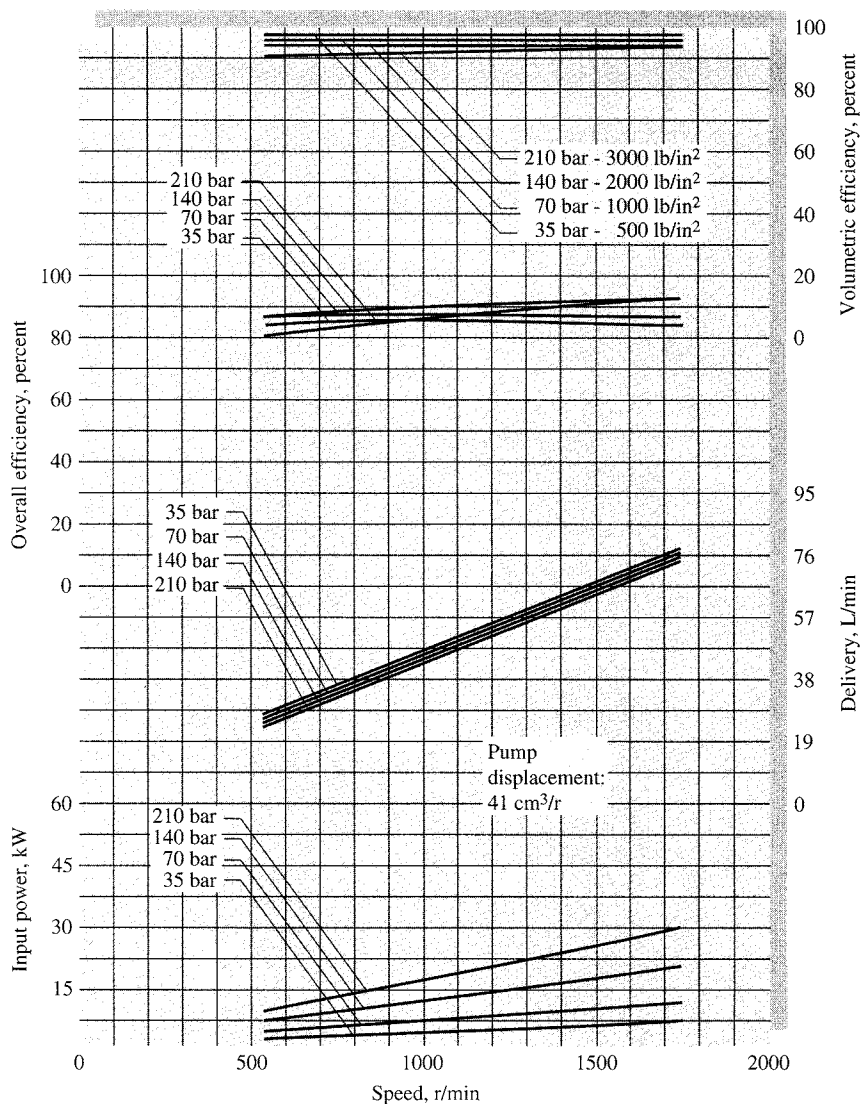


Fig. P11.9

**11.10** Suppose that the pump of Fig. P11.9 is run at 1100 r/min against a pressure rise of 210 bar. (a) Using the measured displacement, estimate the theoretical delivery in gal/min. From the chart, estimate (b) the actual delivery; and (c) the overall efficiency.

**Solution:** (a) From Fig. P11.9, the pump displacement is  $41 \text{ cm}^3$ . The theoretical delivery is

$$Q = \left(1100 \frac{\text{r}}{\text{min}}\right) \left(41 \frac{\text{cm}^3}{\text{r}}\right) = 45100 \frac{\text{cm}^3}{\text{min}} = 45 \frac{\text{L}}{\text{min}} = \mathbf{11.9 \frac{\text{gal}}{\text{min}}} \quad \text{Ans. (a)}$$

(b) From Fig. P11.9, at 1100 r/min and  $\Delta p = 210$  bar, read

$$Q \approx 47 \text{ L/min} \approx \mathbf{12 \text{ gal/min.}} \quad \text{Ans. (b)}$$

(c) From Fig. P11.9, at 1100 r/min and  $\Delta p = 210$  bar, read  $\eta_{\text{overall}} \approx \mathbf{87\%}$ . *Ans. (c)*

**11.11** A pump delivers 1500 L/min of water at 20°C against a pressure rise of 270 kPa. Kinetic and potential energy changes are negligible. If the driving motor supplies 9 kW, what is the overall efficiency?

**Solution:** With pressure rise given, we don't need density. Compute "water" power:

$$P_{\text{water}} = \rho g Q H = Q \Delta p = \left( \frac{1.5 \text{ m}^3}{60 \text{ s}} \right) \left( 270 \frac{\text{kN}}{\text{m}^2} \right) = 6.75 \text{ kW}, \quad \therefore \eta = \frac{6.75}{9.0} = \mathbf{75\%} \quad \text{Ans.}$$

**11.12** In a test of the pump in the figure, the data are:  $p_1 = 100$  mmHg (vacuum),  $p_2 = 500$  mmHg (gage),  $D_1 = 12$  cm, and  $D_2 = 5$  cm. The flow rate is 180 gal/min of light oil (SG = 0.91). Estimate (a) the head developed; and (b) the input power at 75% efficiency.

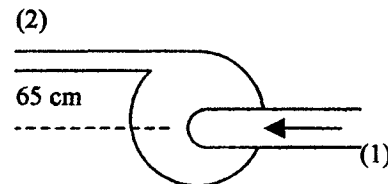


Fig. P11.12

**Solution:** Convert 100 mmHg = 13332 Pa, 500 mmHg = 66661 Pa, 180 gal/min = 0.01136 m<sup>3</sup>/s. Compute  $V_1 = Q/A_1 = 0.01136/[(\pi/4)(0.12)^2] = 1.00$  m/s. Also,  $V_2 = Q/A_2 = 5.79$  m/s. Calculate  $\gamma_{\text{oil}} = 0.91(9790) = 8909$  N/m<sup>3</sup>. Then the head is

$$\begin{aligned} H &= \frac{p_2}{\gamma} + \frac{V_2^2}{2g} + z_2 - \frac{p_1}{\gamma} - \frac{V_1^2}{2g} - z_1 \\ &= \frac{66661}{8909} + \frac{(5.79)^2}{2(9.81)} + 0.65 - \frac{-13332}{8909} - \frac{(1.00)^2}{2(9.81)} - 0, \quad \text{or: } \mathbf{H = 11.3 \text{ m}} \quad \text{Ans. (a)} \end{aligned}$$

$$\text{Power} = \frac{\gamma Q H}{\eta} = \frac{8909(0.01136)(11.3)}{0.75} = \mathbf{1520 \text{ W}} \quad \text{Ans. (b)}$$

**11.13** A 20-hp pump delivers 400 gal/min of gasoline at 20°C with 80% efficiency. What head and pressure rise result across the pump?

**Solution:** For gasoline at 20°C, take  $\rho \approx 680 \text{ kg/m}^3 \approx 1.32 \text{ slug/ft}^3$ . Compute the power

$$P = 20 \times 550 = 11000 \frac{\text{ft}\cdot\text{lb}_f}{\text{s}} = \frac{\rho g Q H}{\eta} = \frac{1.32(32.2) \left( \frac{400}{449} \right) H}{0.80}, \text{ solve } H \approx \mathbf{232 \text{ ft}} \text{ Ans. (a)}$$

$$\text{Then } \Delta p = \rho g H = 1.32(32.2)(232) = 9870 \text{ psf} \div 144 \approx \mathbf{69 \text{ psi}} \text{ Ans. (b)}$$

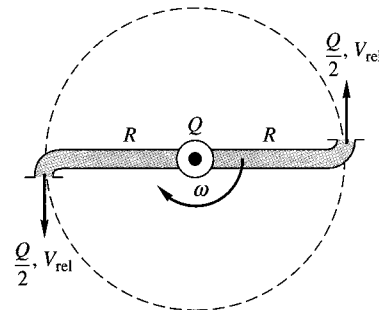
**11.14** A pump delivers gasoline at 20°C and 12 m<sup>3</sup>/h. At the inlet,  $p_1 = 100 \text{ kPa}$ ,  $z_1 = 1 \text{ m}$ , and  $V_1 = 2 \text{ m/s}$ . At the exit  $p_2 = 500 \text{ kPa}$ ,  $z_2 = 4 \text{ m}$ , and  $V_2 = 3 \text{ m/s}$ . How much power is required if the motor efficiency is 75%?

**Solution:** For gasoline, take  $\rho g \approx 680(9.81) = 6671 \text{ N/m}^3$ . Compute head and power:

$$H = \frac{p_2}{\rho g} + \frac{V_2^2}{2g} + z_2 - \frac{p_1}{\rho g} - \frac{V_1^2}{2g} - z_1 = \frac{500000}{6671} + \frac{(3)^2}{2(9.81)} + 4 - \frac{100000}{6671} - \frac{(2)^2}{2(9.81)} - 1,$$

$$\text{or: } H \approx 63.2 \text{ m, Power} = \frac{\rho g Q H}{\eta} = \frac{6671 \left( \frac{12}{3600} \right) (63.2)}{0.75} \approx \mathbf{1870 \text{ W}} \text{ Ans.}$$

**11.15** A lawn sprinkler can be used as a simple turbine. As shown in Fig. P11.15, flow enters normal to the paper in the center and splits evenly into  $Q/2$  and  $V_{\text{rel}}$  leaving each nozzle. The arms rotate at angular velocity  $\omega$  and do work on a shaft. Draw the velocity diagram for this turbine. Neglecting friction, find an expression for the power delivered to the shaft. Find the rotation rate for which the power is a maximum.



**Fig. P11.15**

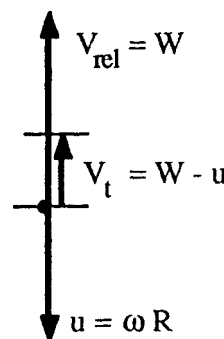
**Solution:** Utilizing the velocity diagram at right, we apply the Euler turbine formula:

$$P = \rho Q(u_2 V_{t2} - u_1 V_{t1}) = \rho Q[u(W - u) - 0]$$

$$\text{or: } \mathbf{P = \rho Q \omega R (V_{\text{rel}} - \omega R)} \text{ Ans.}$$

$$\frac{dP}{du} = \rho Q(V_{\text{rel}} - 2u) = 0 \text{ if } \omega = \frac{V_{\text{rel}}}{2R} \text{ Ans.}$$

$$\text{where } P_{\text{max}} = \rho Q u(2u - u) = \rho Q (\omega R)^2$$



**11.16** For the “sprinkler turbine” of Fig. P11.15, let  $R = 18$  cm, with total flow rate of  $14 \text{ m}^3/\text{h}$  of water at  $20^\circ\text{C}$ . If the nozzle exit diameter is  $8 \text{ mm}$ , estimate (a) the maximum power delivered in  $\text{W}$  and (b) the appropriate rotation rate in  $\text{r/min}$ .

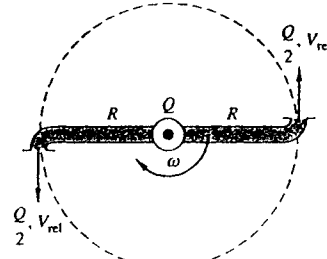


Fig. P11.15

**Solution:** For water at  $20^\circ\text{C}$ , take  $\rho \approx 998 \text{ kg/m}^3$ . Each arm takes  $7 \text{ m}^3/\text{h}$ :

$$V_{\text{rel}} = \frac{Q/2}{A_{\text{exit}}} = \frac{7/3600}{(\pi/4)(0.008)^2} = 38.7 \frac{\text{m}}{\text{s}}; \quad \text{at max power,}$$

$$u = \omega R = \frac{1}{2} V_{\text{rel}} = 19.34 \frac{\text{m}}{\text{s}} = \omega(0.18 \text{ m}), \quad \text{solve } \omega = 107 \frac{\text{rad}}{\text{s}} \approx \mathbf{1030 \text{ rpm}} \quad \text{Ans. (b)}$$

$$P_{\text{max}} = \rho Q u^2 = 998(14/3600)(19.34)^2 \approx \mathbf{1450 \text{ W}} \quad \text{Ans. (a)}$$

**11.17** A centrifugal pump has  $d_1 = 7$  in,  $d_2 = 13$  in,  $b_1 = 4$  in,  $b_2 = 3$  in,  $\beta_1 = 25^\circ$ , and  $\beta_2 = 40^\circ$  and rotates at  $1160 \text{ r/min}$ . If the fluid is gasoline at  $20^\circ\text{C}$  and the flow enters the blades radially, estimate the theoretical (a) flow rate in  $\text{gal/min}$ , (b) horsepower, and (c) head in ft.

**Solution:** For gasoline, take  $\rho \approx 1.32 \text{ slug/ft}^3$ . Compute  $\omega = 1160 \text{ rpm} = 121.5 \text{ rad/s}$ .

$$u_1 = \omega r_1 = 121 \left( \frac{3.5}{12} \right) \approx 35.4 \text{ ft/s}$$

$$V_{n1} = u_1 \tan \beta_1 = 35.4 \tan 25^\circ \approx 16.5 \text{ ft/s}$$

$$Q = 2\pi r_1 b_1 V_{n1} = 2\pi \left( \frac{3.5}{12} \right) \left( \frac{4}{12} \right) (16.5) \\ \approx \mathbf{10 \frac{\text{ft}^3}{\text{s}}} \quad \text{Ans. (a)}$$

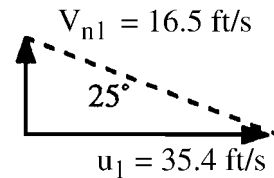
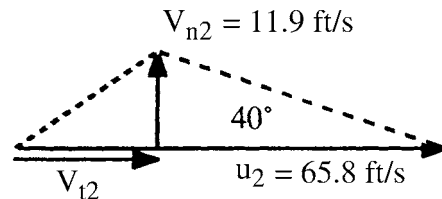


Fig. P11.17

$$V_{n2} = \frac{Q}{2\pi r_2 b_2} = \frac{10.0}{2\pi \left( \frac{6.5}{12} \right) \left( \frac{3}{12} \right)} \approx 11.9 \frac{\text{ft}}{\text{s}}$$

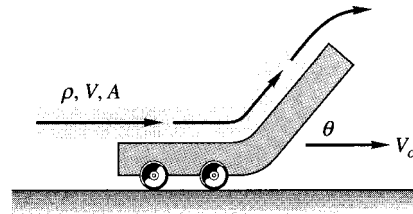
$$u_2 = \omega r_2 = 121(6.5/12) \approx 65.8 \text{ ft/s}$$

$$V_{t2} = u_2 - V_{n2} \cot 40^\circ \approx 51.7 \text{ ft/s}$$



Finally,  $\mathbf{P}_{\text{ideal}} = \rho Q u_2 V_{12} = 1.32(10.0)(65.8)(51.7) = 44900 \div 550 \approx \mathbf{82 \text{ hp}}$ . *Ans. (b)*  
 Theoretical head  $\mathbf{H} = P/(\rho g Q) = 44900/[1.32(32.2)(10.0)] \approx \mathbf{106 \text{ ft}}$ . *Ans. (c)*

**11.18** A jet of velocity  $V$  strikes a vane which moves to the right at speed  $V_c$ , as in Fig. P11.18. The vane has a turning angle  $\theta$ . Derive an expression for the power delivered to the vane by the jet. For what vane speed is the power maximum?



**Fig. P11.18**

**Solution:** The jet approaches the vane at relative velocity  $(V - V_c)$ . Then the force is

$$F = \rho A (V - V_c)^2 (1 - \cos \theta), \text{ and Power} = F V_c = \rho A V_c (V - V_c)^2 (1 - \cos \theta) \quad \text{Ans. (a)}$$

Maximum power occurs when  $\frac{dP}{dV_c} = 0$ ,

$$\text{or: } V_c = \frac{1}{3} V_{\text{jet}} \quad \text{Ans. (b)} \quad \left( P = \frac{4}{27} \rho A V^3 [1 - \cos \theta] \right)$$

**11.19** A centrifugal water pump has  $r_2 = 9$  in,  $b_2 = 2$  in, and  $\beta_2 = 35^\circ$  and rotates at 1060 r/min. If it generates a head of 180 ft, determine the theoretical (a) flow rate in gal/min and (b) horsepower. Assume near-radial entry flow.

**Solution:** For water take  $\rho = 1.94$  slug/ft<sup>3</sup>. Convert  $\omega = 1060$  rpm = 111 rad/s. Then

$$u_2 = \omega r_2 = 111 \left( \frac{9}{12} \right) = 83.3 \frac{\text{ft}}{\text{s}};$$

$$\text{Power} = \rho Q u_2 \left( u_2 - \frac{Q}{2\pi r_2 b_2} \cot \beta_2 \right), \quad \text{and} \quad H = \frac{P}{\rho g Q} = 180 \text{ ft}$$

$$\text{or: } P = 62.4 Q H = 1.94 Q (83.3) \left[ 83.3 - \frac{Q}{2\pi(9/12)(2/12)} \cot 35^\circ \right] \quad \text{with } H = 180$$

$$\text{Solve for } \mathbf{Q} = 7.5 \text{ ft}^3/\text{s} \approx \mathbf{3360 \text{ gal/min}} \quad \text{Ans. (a)}$$

With  $Q$  and  $H$  known,  $\mathbf{P} = \rho g Q H = 62.4(7.5)(180) \div 550 \approx \mathbf{153 \text{ hp}}$ . *Ans. (b)*



**11.20** Suppose that Prob. 11.19 is reversed into a statement of the theoretical power  $P = 153$  hp. Can you then compute the theoretical (a) flow rate; and (b) head? Explain and resolve the difficulty which arises.

**Solution:** With power known, the basic theory becomes quadratic in flow rate:

$$u_2 = 83.3 \frac{\text{ft}}{\text{s}}, \quad P = \rho Q u_2 \left( u_2 - \frac{Q}{2\pi r_2 b_2} \cot \beta_2 \right)$$

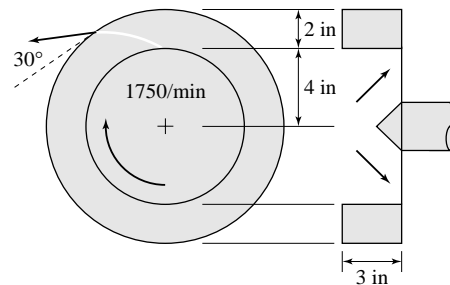
$$= 1.94 Q (83.3) [83.3 - 1.818 Q] = 153 \times 550 \frac{\text{ft} \cdot \text{lbf}}{\text{s}}$$

Clean up:  $Q^2 - 45.8Q + 287 = 0$ , two roots:  $Q_1 = 7.5 \frac{\text{ft}^3}{\text{s}}$ ;  $Q_2 = 38.3 \frac{\text{ft}^3}{\text{s}}$  *Ans. (a)*

These correspond to  $H_1 = 180 \text{ ft}$ ;  $H_2 = 35 \text{ ft}$  *Ans. (b)*

So the ideal pump theory admits to two valid combinations of  $Q$  and  $H$  which, for the given geometry and speed, give the theoretical power of 153 hp. Prob. 11.19 was solution 1.

**11.21** The centrifugal pump of Fig. P11.21 develops a flow rate of 4200 gpm with gasoline at  $20^\circ\text{C}$  and near-radial absolute inflow. Estimate the theoretical (a) horsepower; (b) head rise; and (c) appropriate blade angle at the inner radius.



**Fig. P11.21**

**Solution:** For gasoline take  $\rho \approx 1.32 \text{ slug/ft}^3$ . Convert  $Q = 4200 \text{ gal/min} = 9.36 \text{ ft}^3/\text{s}$  and  $\omega = 1750 \text{ rpm} = 183 \text{ rad/s}$ . Note  $r_2 = 6 \text{ in}$  and  $\beta_2 = 30^\circ$ . The ideal power is computed as

$$P = \rho Q u_2 \left( u_2 - \frac{Q}{2\pi r_2 b_2} \cot \beta_2 \right), \quad \text{where } u_2 = \omega r_2 = 183 \left( \frac{6}{12} \right) \approx 91.6 \text{ ft/s.} \quad \text{Plug in:}$$

$$P = 1.32(9.36)(91.6) \left[ 91.6 - \frac{9.36}{2\pi(6/12)(3/12)} \cot 30^\circ \right] = 80400 \div 550 \approx \mathbf{146 \text{ hp}} \quad \text{Ans. (a)}$$

$$H = \frac{P}{\rho g Q} = \frac{80400}{1.32(32.2)(9.36)} \approx \mathbf{202 \text{ ft}} \quad \text{Ans. (b)}$$

Compute  $V_{n1} = Q/[2\pi r_1 b_1] = 9.36/[2\pi(4/12)(3/12)] \approx 17.9$  ft/s,  $u_1 = \omega r_1 = 183(4/12) \approx 61.1$  ft/s. For purely radial inflow,  $\beta_1 = \tan^{-1}(17.9/61.1) \approx 16^\circ$ . *Ans. (c)*

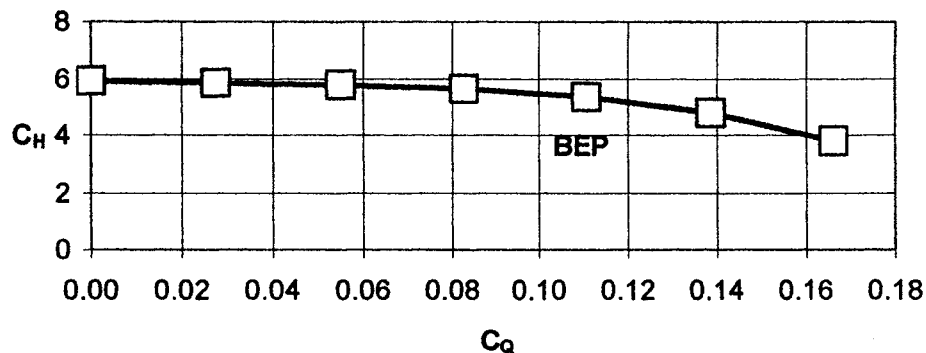
**11.22** A 37-cm-diameter centrifugal pump, running at 2140 rev/min with water at 20°C produces the following performance data:

Q, m <sup>3</sup> /s:	0.0	0.05	0.10	0.15	0.20	0.25	0.30
H, m:	105	104	102	100	95	85	67
P, kW:	100	115	135	171	202	228	249
$\eta$ :	0%	44%	74%	86%	<u>92%</u>	91%	79%

(a) Determine the best efficiency point. (b) Plot  $C_H$  versus  $C_Q$ . (c) If we desire to use this same pump family to deliver 7000 gal/min of kerosene at 20°C at an input power of 400 kW, what pump speed (in rev/min) and impeller size (in cm) are needed? What head will be developed?

**Solution:** Efficiencies, computed by  $\eta = \rho g Q H / \text{Power}$ , are listed above. The best efficiency point (BEP) is approximately **92% at  $Q = 0.2$  m<sup>3</sup>/s**. *Ans. (a)*

The dimensionless coefficients are  $C_Q = Q/(nD^3)$ , where  $n = 2160/60 = 36$  rev/s and  $D = 0.37$  m, plus  $C_H = gH/(n^2 D^2)$  and  $C_P = P/(\rho n^3 D^5)$ , where  $\rho_{\text{water}} = 998$  kg/m<sup>3</sup>. BEP values are  $C_Q^* = 0.111$ ,  $C_H^* = 5.35$ , and  $C_P^* = 0.643$ . **A plot of  $C_H$  versus  $C_Q$  is below.** The values are similar to Fig. 11.8 of the text. *Ans. (b)*



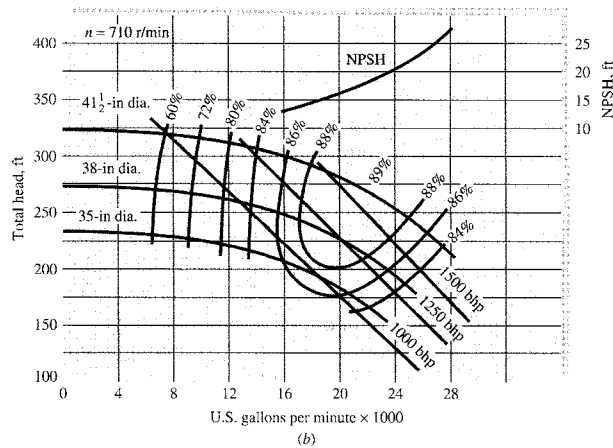
(c) For kerosene,  $\rho_k = 804$  kg/m<sup>3</sup>. Convert 7000 gal/min = 0.442 m<sup>3</sup>/s. At BEP, we require the above values of dimensionless parameters:

$$\frac{Q}{nD^3} = \frac{0.442}{nD^3} = 0.111; \quad \frac{P}{\rho n^3 D^5} = \frac{400000}{804 n^3 D^5} = 0.643;$$

$$\text{Solve } n = 26.1 \frac{\text{rev}}{\text{s}} = \mathbf{1560 \frac{\text{rev}}{\text{min}}}; \quad D = \mathbf{0.534 \text{ m}} \quad \text{Ans. (c)}$$

$$\text{Also, } H^* = C_H^*(n^2 D^2)/g = 5.35(26.1)^2(0.534)^2/9.81 = \mathbf{106 \text{ m}} \quad \text{Ans. (c)}$$

**11.23** If the 38-in pump from Fig. 11.7(b) is used to deliver 20°C kerosene, at 850 rpm and 22000 gal/min, what (a) head; and (b) brake horsepower will result?



**Fig. 11.7b**

**Solution:** For kerosene, take  $\rho = 1.56 \text{ slug/ft}^3$  and for water  $\rho = 1.94 \text{ slug/ft}^3$ . Use the scaling laws, Eq. (11.28):

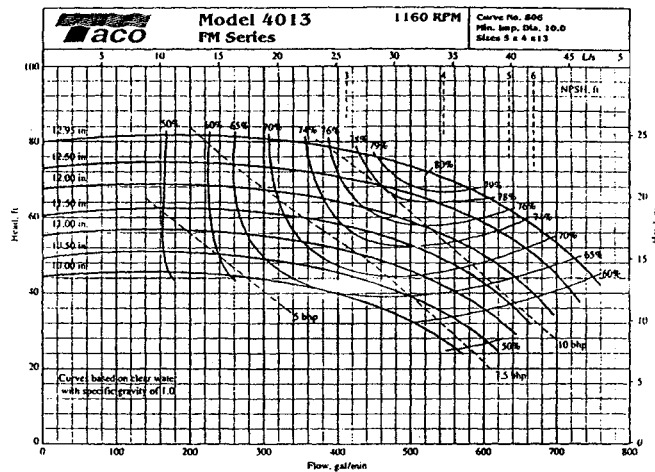
$$\frac{Q_1}{Q_2} = \frac{n_1}{n_2} \left( \frac{D_1}{D_2} \right)^3 = \frac{Q_1}{22000} = \frac{710}{850}, \quad \therefore Q_1 \approx 18400 \text{ gpm}$$

$$\text{Read } H_1 \approx 235 \text{ ft} \quad \text{and} \quad P_1 \approx 1175 \text{ bhp}$$

$$D_1 = D_2: \quad H_2 = 235 \left( \frac{850}{710} \right)^2 \approx \mathbf{340 \text{ ft}} \quad \text{Ans. (a)}$$

$$P_2 = P_1(\rho_2/\rho_1)(n_2/n_1)^3 = 1175(1.56/1.94)(850/710)^3 \approx \mathbf{1600 \text{ bhp}} \quad \text{Ans. (b)}$$

**11.24** Figure P11.24 shows performance data for the Taco, Inc., model 4013 pump. Compute the ratios of measured shutoff head to the ideal value  $U^2/g$  for all seven impeller sizes. Determine the average and standard deviation of this ratio and compare it to the average for the six impellers in Fig. 11.7.



**Fig. P11.24** Performance data for a centrifugal pump.  
(Courtesy of Taco, Inc., Cranston, Rhode Island.)

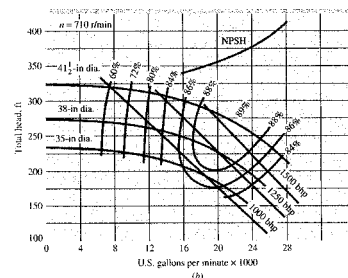
**Solution:** All seven pumps are run at 1160 rpm = 121 rad/s. The 7 diameters are given. Thus we can easily compute  $U = \omega r = \omega D/2$  and construct the following table:

D, inches:	10.0	10.5	11.0	11.5	12.0	12.5	12.95
U, ft/s:	50.6	53.1	55.7	58.2	60.7	63.3	65.5
$H_0$ , ft:	44	49	53	61	67	73	80
$H_0/(U^2/g)$ :	<b>0.553</b>	<b>0.559</b>	<b>0.551</b>	<b>0.580</b>	<b>0.585</b>	<b>0.587</b>	<b>0.599</b>

The average ratio is **0.573** Ans. (a), and the standard deviation is **0.019**. Ans. (b)

For the six pumps of Fig. 11.7, the average is *0.611*, the standard deviation is *0.025*. These results are true of most centrifugal pumps: we can take an average of  $0.60 \pm 0.04$ .

**11.25** At what speed in rpm should the 35-in-diameter pump of Fig. 11.7(b) be run to produce a head of 400 ft at a discharge of 20000 gal/min? What brake horsepower will be required? *Hint:* Fit  $H(Q)$  to a formula.



**Fig. 11.7b**

**Solution:** A curve-fit formula for  $H(Q)$  for this pump is  $H(\text{ft}) \approx 235 - 0.125Q^2$ , with  $Q$  in kgal/min. Then, for constant diameter, the similarity rules predict

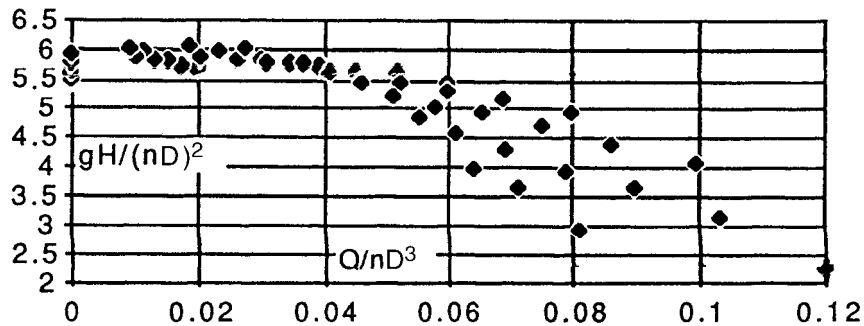
$$H_1 = H_2 \left( \frac{n_1}{n_2} \right)^2 \quad \text{and} \quad Q_1 = Q_2 \left( \frac{n_1}{n_2} \right), \quad \text{or:} \quad H_1 = 400 \left( \frac{710}{n_2} \right)^2 \approx 235 - 0.125 \left[ 20 \left( \frac{710}{n_2} \right) \right]^2$$

$$\text{Solve for } n_2 = \left( \frac{2.27E8}{235} \right)^{1/2} \approx \mathbf{980 \text{ rpm}} \quad \text{Ans.}$$

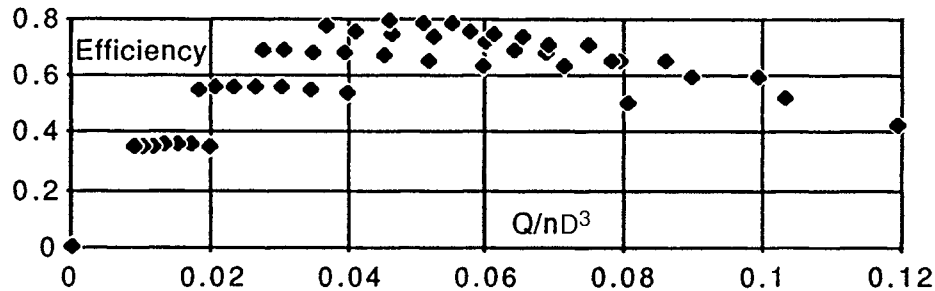
Now backtrack to compute  $H_1 \approx 210$  ft and  $Q_1 \approx 14500$  gal/min. From Fig. 11.7(b) we may then read the power  $P_1 \approx 900$  bhp (or compute this from  $\eta_1 \approx 0.85$ ). Then, by similarity,  $P_2 = (n_2/n_1)^3 = 900(980/710)^3 \approx \mathbf{2400}$  bhp. *Ans.*

**11.26** Determine if the seven Taco, Inc. pumps in Fig. 11.24 on the previous page can be collapsed into a single dimensionless chart of  $C_H$ ,  $C_P$ , and  $\eta$  versus  $C_Q$ , as in Fig. 11.8 of the text. Comment on the results.

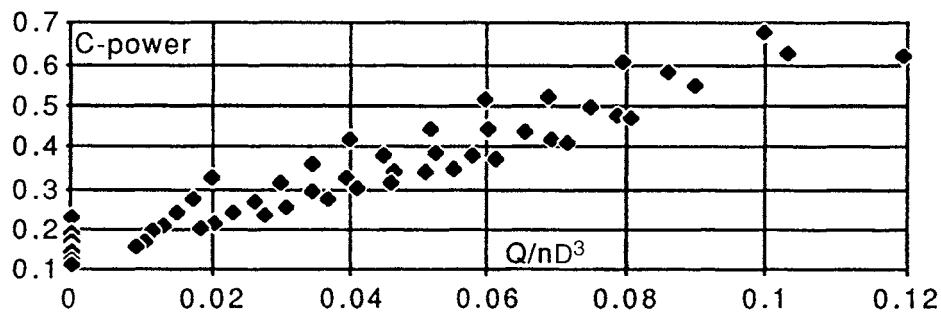
**Solution:** The head curves collapse *fairly well*, especially at low flow rates. Higher flow rates are poorer, as shown below. Recall that these pumps are not geometrically similar but rather consist of different sized impellers inside a single large housing.



Efficiencies are more scattered and rise significantly with impeller size:



The power coefficients are also rather scattered, probably due to geometric nonsimilarity:



In all these curves above, “n” is taken in revolutions per second ( $1160/60 \approx 19.33$  rps).

**11.27** The 12-in pump of Fig. P11.24 is to be scaled up in size to provide a head of 90 ft and a flow rate of 1000 gal/min at BEP. Determine the correct (a) impeller diameter; (b) speed in rpm; and (c) horsepower required.

**Solution:** From the chart, at BEP,  $Q \approx 480$  gpm,  $H \approx 60$  ft, and  $\eta \approx 76.5\%$ , from which

$$P = \frac{\rho g Q H}{\eta} = \frac{(62.4)(480/449)(60)}{0.765} \approx 5234 \frac{\text{ft}\cdot\text{lb}}{\text{s}},$$

$$C_P^* = \frac{P}{\rho n^3 D^5} = \frac{5234}{1.94(19.3)^3(1)^5} \approx 0.373$$

$$C_Q^* = \frac{Q^*}{nD^3} = \frac{480/449}{(19.3)(1)^3} \approx 0.0553; \quad C_H^* = \frac{gH^*}{n^2 D^2} = \frac{(32.2)(60)}{(19.3)^2(1)^2} \approx 5.17$$

$$\text{Larger pump, } H = 90, Q = 1000: \quad \frac{32.2(90)}{n^2 D^2} \approx 5.17, \quad \frac{1000/449}{nD^3} \approx 0.0553$$

Solve for  $D \approx 1.305$  ft  $\approx$  **15.7 in** *Ans.* (a) and  $n \approx 18.15$  rps  $\approx$  **1090 rpm** *Ans.* (b)

$$P^* = C_P^* \rho n^3 D^5 = 0.373(1.94)(18.15)^3(1.305)^5 \approx 16300 \frac{\text{ft}\cdot\text{lb}}{\text{s}} \div 550 \approx \mathbf{30 \text{ bhp}}$$
 *Ans.* (c)

**11.28** Tests by the Byron Jackson Co. of a 14.62-in centrifugal water pump at 2134 rpm yield the data below. What is the BEP? What is the specific speed? Estimate the max discharge.

$Q$ , ft <sup>3</sup> /s:	0	2	4	6	8	10
$H$ , ft:	340	340	340	330	300	220
bhp:	135	160	205	255	330	330

**Solution:** The efficiencies are computed from  $\eta = \rho g Q H / (550 \text{ bhp})$  and are as follows:

$Q$ :	0	2	4	<b>6</b>	8	10
$\eta$ :	0	0.482	0.753	<b>0.881</b>	0.825	0.756

Thus the BEP is, even without a plot, close to  $Q \approx 6$  ft<sup>3</sup>/s. *Ans.* The specific speed is

$$N_s \approx \frac{nQ^{*1/2}}{H^{*3/4}} = \frac{2134[(6)(449)]^{1/2}}{(330)^{3/4}} \approx \mathbf{1430}$$
 *Ans.*

For estimating  $Q_{\max}$ , the last three points fit a Power-law to within  $\pm 0.5\%$ :

$$H \approx 340 - 0.00168Q^{4.85} = 0 \quad \text{if } Q \approx \mathbf{12.4} \frac{\text{ft}^3}{\text{s}} = Q_{\max} \quad \text{Ans.}$$


---

**11.29** If the scaling laws are applied to the Byron Jackson pump of Prob. 11.28 for the same impeller diameter, determine (a) the speed for which the shut-off head will be 280 ft; (b) the speed for which the BEP flow rate will be  $8.0 \text{ ft}^3/\text{s}$ ; and (c) the speed for which the BEP conditions will require 80 horsepower.

**Solution:** From the table in Prob. 11.28, the shut-off head at 2134 rpm is 340 ft. Thus

$$\text{If } D_1 = D_2, \quad n_2 = n_1(H_2/H_1)^{1/2} = 2134(280/340)^{1/2} \approx \mathbf{1940 \text{ rpm}} \quad \text{Ans. (a)}$$

$$\text{If } Q_2^* = 8 \frac{\text{ft}^3}{\text{s}}, \quad n_2 = n_1(Q_2^*/Q_1^*) = 2134(8.0/6.0) \approx \mathbf{2850 \text{ rpm}} \quad \text{Ans. (b)}$$

Finally, if  $\rho_1 = \rho_2$  (water) and the diameters are the same, then  $\text{Power} \propto n^3$ , or, at BEP,

$$n_2 = n_1(P_2^*/P_1^*)^{1/3} = 2134(80/255)^{1/3} \approx \mathbf{1450 \text{ rpm}} \quad \text{Ans. (c)}$$


---

**11.30** A pump from the same family as Prob. 11.28 is built with  $D = 18$  in and a BEP power of 250 bhp for *gasoline* (not water). Using the scaling laws, estimate the resulting (a) speed in rpm; (b) flow rate at BEP; and (c) shutoff head.

**Solution:** For gasoline, take  $\rho \approx 1.32 \text{ slug/ft}^3$ , whereas for water take  $\rho \approx 1.94 \text{ slug/ft}^3$ .

$$\frac{P_2^*}{P_1^*} = \frac{250}{255} = \frac{\rho_2}{\rho_1} \left(\frac{n_2}{n_1}\right)^3 \left(\frac{D_2}{D_1}\right)^5 = \left(\frac{1.32}{1.94}\right) \left(\frac{n_2}{2134}\right)^3 \left(\frac{18.0}{14.62}\right)^5,$$

$$\text{Solve } n_2 \approx \mathbf{1700 \text{ rpm}} \quad \text{Ans. (a)}$$

$$\text{Then } Q_2^* = Q_1^* \left(\frac{n_2}{n_1}\right) \left(\frac{D_2}{D_1}\right)^3 = (6.0) \left(\frac{1700}{2134}\right) \left(\frac{18.0}{14.62}\right)^3 \approx \mathbf{8.9} \frac{\text{ft}^3}{\text{s}} \quad \text{Ans. (b)}$$

Finally, with the change in speed known and an original shut-off head of 340 ft,

$$H_{o2} = H_{o1} \left(\frac{n_2}{n_1}\right)^2 \left(\frac{D_2}{D_1}\right)^2 = 340 \left(\frac{1700}{2134}\right)^2 \left(\frac{18.0}{14.62}\right)^2 \approx \mathbf{330 \text{ ft}} \quad \text{Ans. (c)}$$


---

**11.31** A centrifugal pump with backward-curved blades has the following measured performance when tested with water at 20°C:

$Q$ , gal/min:	0	400	800	1200	1600	2000	2400
$H$ , ft:	123	115	108	101	93	81	62
$P$ , hp:	30	36	40	44	47	48	46

(a) Estimate the best efficiency point and the maximum efficiency. (b) Estimate the most efficient flow rate, and the resulting head and brake horsepower, if the diameter is doubled and the rotation speed increased by 50%.

**Solution:** (a) Convert the data above into efficiency. For example, at  $Q = 400$  gal/min,

$$\eta = \frac{\gamma QH}{P} = \frac{(62.4 \text{ lbf/ft}^3)(400/448.8 \text{ ft}^3/\text{s})(115 \text{ ft})}{(36 \times 550 \text{ ft}\cdot\text{lbf/s})} = 0.32 = 32\%$$

When converted, the efficiency table looks like this:

$Q$ , gal/min:	0	400	800	1200	1600	2000	2400
$\eta$ , %:	0	32%	55%	70%	80%	85%	82%

So maximum efficiency of **85%** occurs at  **$Q = 2000$  gal/min.** *Ans.* (a)

(b) We don't know the values of  $C_Q^*$  or  $C_H^*$  or  $C_P^*$ , but we can set them equal for conditions 1 (the data above) and 2 (the performance when  $n$  and  $D$  are changed):

$$C_Q^* = \frac{Q_1}{n_1 D_1^3} = \frac{Q_2}{n_2 D_2^3} = \frac{Q_2}{(1.5n_1)(2D_1)^3},$$

$$\text{or: } Q_2 = 12Q_1 = 12(2000 \text{ gpm}) = \mathbf{24,000 \frac{\text{gal}}{\text{min}}} \quad \text{Ans. (b)}$$

$$C_H^* = \frac{gH_1}{n_1^2 D_1^2} = \frac{gH_2}{n_2^2 D_2^2} = \frac{gH_2}{(1.5n_1)^2 (2D_1)^2},$$

$$\text{or: } H_2 = 9H_1 = 9(81 \text{ ft}) = \mathbf{729 \text{ ft}} \quad \text{Ans. (b)}$$

$$C_P^* = \frac{P_1}{\rho n_1^3 D_1^5} = \frac{P_2}{\rho n_2^3 D_2^5} = \frac{P_2}{\rho (1.5n_1)^3 (2D_1)^5},$$

$$\text{or: } P_2 = 108P_1 = 108(48 \text{ hp}) = \mathbf{5180 \text{ hp}} \quad \text{Ans. (b)}$$


---



**11.32** The data of Prob. 11.31 correspond to a pump speed of 1200 r/min. (Were you able to solve Prob. 11.31 without this knowledge?) (a) Estimate the diameter of the impeller [*HINT*: See Prob. 11.24 for a clue.]. (b) Using your estimate from part (a), calculate the BEP parameters  $C_Q^*$ ,  $C_H^*$ , and  $C_P^*$  and compare with Eq. (11.27). (c) For what speed of this pump would the BEP head be 280 ft?

**Solution:** Yes, we were able to solve Prob. 11.31 by simply using *ratios*.

(a) Prob. 11.24 showed that, for a wide range of centrifugal pumps, the shut-off head  $H_o \approx 0.6U^2/g \pm 6\%$ , where  $U$  is the impeller blade tip velocity,  $U = \omega D/2$ . Use this estimate with the shut-off head and speed of the pump in Prob. 11.31:

$$\omega = 2\pi(1200 \text{ rpm})/60 = 126 \text{ rad/s}, \quad H_o \approx 123 \text{ ft} = 0.6[(126D/2)^2/32.2 \text{ ft/s}^2]$$

$$\text{Solve for } D \approx 1.29 \text{ ft} \approx \mathbf{15.5 \text{ in}} \quad \text{Ans. (a)}$$

(b) With diameter  $D \approx 1.29$  ft estimated and speed  $n = 1200/60 = 20$  r/s given, we can calculate:

$$C_Q^* = \frac{(2000/448.8) \text{ ft}^3/\text{s}}{(20 \text{ r/s})(1.29 \text{ ft})^3} \approx \mathbf{0.103}; \quad C_H^* = \frac{(32.2 \text{ ft/s}^2)(81 \text{ ft})}{(20 \text{ r/s})^2(1.29 \text{ ft})^2} \approx \mathbf{3.9}$$

$$C_P^* = \frac{(48)(550 \text{ ft}\cdot\text{lbf/s})}{(1.94 \text{ slug/ft}^3)(20 \text{ r/s})^3(1.29 \text{ ft})^5} \approx \mathbf{0.47} \quad \text{Ans. (b)}$$

(c) Use the estimate of  $C_H^*$  to estimate the speed needed to produce 280 ft of head:

$$C_H^* \approx 3.9 = \frac{(32.2 \text{ ft/s}^2)(280 \text{ ft})}{n^2(1.29 \text{ ft})^2}, \quad \text{solve for } n = 37 \text{ r/s} \approx \mathbf{2230 \text{ r/min}} \quad \text{Ans. (c)}$$

**11.33** For the pump family of Probs. 11.31 and 11.32, find the appropriate (a) diameter and (b) rotation speed which will deliver, at BEP, 5300 gal/min against a head of 210 ft. (c) What is the brake horsepower for this condition?

**Solution:** Armed with the three BEP results from Prob. 11.32, we can solve for these variables:

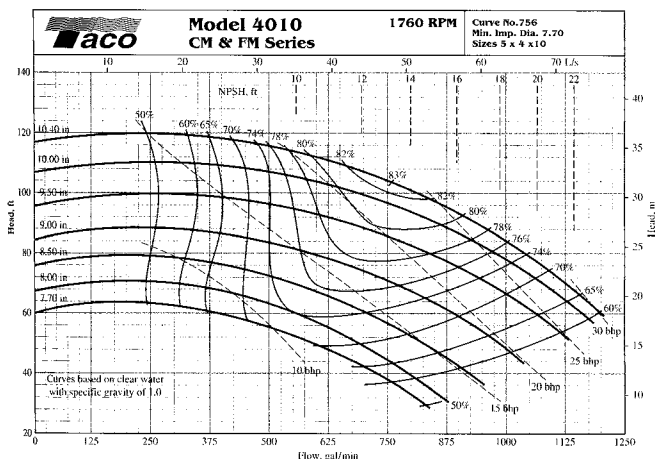
$$\text{(a, b)} \quad C_Q^* = 0.103 = \frac{(5300/448.8) \text{ ft}^3/\text{s}}{n_2 D_2^3}; \quad C_H^* = 3.9 = \frac{(32.2 \text{ ft/s}^2)(210 \text{ ft})}{n_2^2 D_2^2}$$

$$\text{Solve together for } D_2 = 1.66 \text{ ft} \approx \mathbf{20 \text{ in}}, \quad n_2 = 25.1 \text{ r/s} \approx \mathbf{1510 \text{ r/min}} \quad \text{Ans. (a, b)}$$

$$C_P^* = 0.47 = \frac{P_2}{\rho n_2^3 D_2^5} = \frac{P_2}{(1.94 \text{ slug/ft}^3)(25.1 \text{ r/s})^3 (1.66 \text{ ft})^5},$$

$$\text{Solve } P_2 = 181400 \frac{\text{ft}\cdot\text{lbf}}{\text{s}} = \mathbf{330 \text{ hp}} \quad \text{Ans. (c)}$$

**11.34** Consider a pump geometrically similar to the 9-in-diameter pump of Fig. P11.34 to deliver 1200 gal/min of *kerosene* at 1500 rpm. Determine the appropriate (a) impeller diameter; (b) BEP horsepower; (c) shut-off head; and (d) maximum efficiency.



**Fig. P11.34** Performance data for a family of centrifugal pump impellers. (Courtesy of Taco, Inc., Cranston, Rhode Island.)

**Solution:** For kerosene, take  $\rho \approx 1.56 \text{ slug/ft}^3$ , whereas for water  $\rho \approx 1.94 \text{ slug/ft}^3$ . From Fig. P11.34, at BEP, read  $Q^* \approx 675 \text{ gpm}$ ,  $H^* \approx 76 \text{ ft}$ , and  $\eta_{\max} \approx 0.77$ . Then

$$C_Q^* = \frac{Q^*}{nD^3} = \frac{675/449}{(1760/60)(9/12)^3} \approx 0.122 = \frac{1200/449}{(1500/60)D^3},$$

$$\text{Solve for } D_{\text{imp}} \approx 0.96 \text{ ft} \approx \mathbf{11.5 \text{ in}} \quad \text{Ans. (a)}$$

$$\text{Shut-off: } \frac{gH_0}{n^2 D^2} = \frac{32.2(84 \text{ ft})}{(1760/60)^2 (9/12)^2} = \frac{32.2H_0}{(1500/60)^2 (0.96)^2},$$

$$\text{Solve } H_0 \approx \mathbf{100 \text{ ft}} \quad \text{Ans. (c)}$$

$$\text{Moody: } \frac{1 - \eta_2}{1 - 0.77} \approx \left( \frac{9.0}{11.5} \right)^{1/4}, \quad \text{solve for } \eta_2 \approx \mathbf{0.784} \quad \text{Ans. (d) (crude estimate)}$$

$$\text{Fig. P11.34: Read } H^* \approx 76 \text{ ft, whence } \frac{32.2(76)}{(29.3)^2 (0.75)^2} = \frac{32.2 H_{\text{new}}^*}{(25)^2 (0.96)^2},$$

$$\text{or } H_{\text{new}}^* \approx 90.1 \text{ ft}$$

$$\text{Then } P_{\text{new}}^* = \frac{1.56(32.2)(1200/449)(90.1)}{0.784} \approx 15440 \frac{\text{ft}\cdot\text{lb}_f}{\text{s}} \div 550 \approx \mathbf{28 \text{ bhp}} \quad \text{Ans. (b)}$$

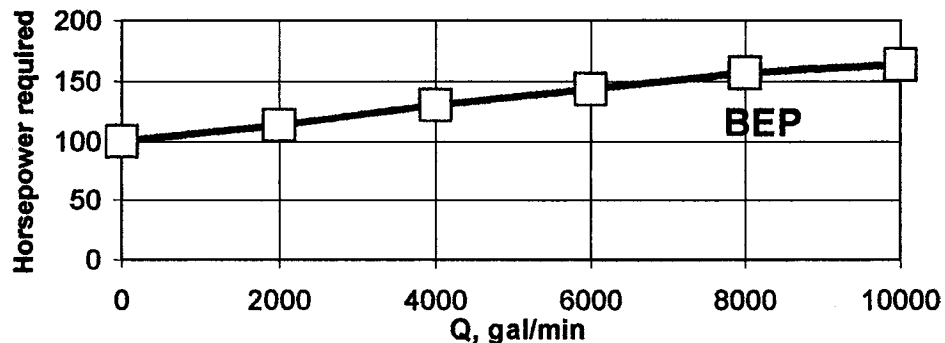
**11.35** An 18-in-diameter centrifugal pump, running at 880 rev/min with water at 20°C, generates the following performance data:

Q, gal/min:	0.0	2000	4000	6000	8000	10000
H, ft:	92	89	84	78	68	50
P, hp:	100	112	130	143	156	163
$\eta$ :	<b>0%</b>	<b>40%</b>	<b>65%</b>	<b>83%</b>	<b>88%</b>	<b>78%</b>

Determine (a) the BEP; (b) the maximum efficiency; and (c) the specific speed. (d) Plot the required input power versus the flow rate.

**Solution:** We have computed the efficiencies and listed them. The BEP is the next-to-last point: **Q = 8000 gal/min,  $\eta_{\text{max}} = 88\%$** . *Ans. (a, b)* The specific speed is  $N'_s = nQ^{*1/2}/(gH^*)^{3/4} = (880/60)(8000/448.83)^{1/2}/[32.2(68)]^{3/4} \approx \mathbf{0.193}$ , or  $N_s = \mathbf{3320}$  (probably a centrifugal pump). *Ans. (c)*

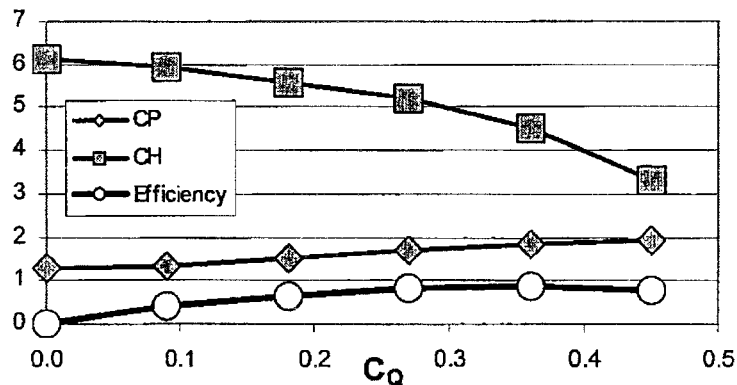
The plot of input horsepower versus flow rate is shown below—there are no surprises in this plot. *Ans. (d)*



**11.36** Plot the dimensionless performance curves for the pump of Prob. P11.35 and compare with Fig. 11.8 of the text. Find the appropriate diameter in inches and the speed, in rev/min, for a geometrically similar pump to deliver 400 gal/min against a head of 200 ft. What brake horsepower would be required?

**Solution:** The data are plotted below in the form of  $C_H$ ,  $C_P$ , and  $\eta$  versus  $C_Q$ . The head and power coefficients are about the same as Fig. 11.8 of the text, but the flow

coefficients are four time larger, primarily because the specific speed here is twice as large as that of Fig. 11.8.



Maximum efficiency occurs at about  $C_Q^* \approx 0.36$ , for which  $C_H^* \approx 4.52$ . Thus, for the proposed new conditions ( $H = 200$  ft,  $Q = 400$  gal/min), we obtain best efficiency at

$$C_Q^* = 0.36 = \frac{(400/448.83) \text{ ft}^3/\text{s}}{nD^3} \quad \text{and} \quad C_H^* = 4.52 = \frac{(32.2 \text{ ft/s}^2)(200 \text{ ft})}{n^2 D^2}$$

Solve simultaneously for  $D = 0.256$  ft = **3.1 in** and  $n = 147$  r/s = **8830 r/min**. *Ans.*

This is a poor result: too small and too high a speed. Better designs are available. We could retain the efficiency of 88%, or the Moody step-up formula, Eq. (11.29a), will predict a lower efficiency of 81%. The horsepower required would be

$$P = \frac{\rho g Q H}{\eta} = \frac{(62.4 \text{ lbf/ft}^3)(400/449 \text{ ft}^3/\text{s})(200 \text{ ft})}{0.81} = 13700 \frac{\text{ft}\cdot\text{lbf}}{\text{s}} \div 550 \approx \mathbf{25 \text{ bhp}} \quad \text{Ans.}$$

**11.37** Knowing that the pump of Prob. 11.35 has BEP at  $Q = 8000$  gal/min, use the similarity rules to find the appropriate (a) impeller diameter, (b) rotation speed, and (c) head produced for a pump of the same family delivering 1000 gal/min at 12 brake horsepower.

**Solution:** In Prob. 11.35 maximum efficiency of 88%, for a diameter of 1.5 ft, was found at  $Q = 8000$  gal/min,  $H = 68$  ft,  $P = 156$  hp, and  $n = 880/60$  r/s. From this compute  $C_Q^* = 0.360$ ,  $C_H^* = 4.52$ , and  $C_P^* = 1.85$ . ( $N_s$  was about 3320.) Apply the BEP coefficients to the new data:

$$C_Q^* = \frac{Q_2}{n_2 D_2^3} = 0.360 = \frac{1000/449}{n_2 D_2^3}; \quad C_H^* = \frac{g H_2}{n_2^2 D_2^2} = 4.52 = \frac{(32.2) H_2}{n_2^2 D_2^2}$$

$$C_P^* = \frac{P_2}{\rho n_2^3 D_2^5} = 1.85 = \frac{12(550)}{(1.94) n_2^3 D_2^5}$$

Solve simultaneously, or use EES, to obtain:

$$(a) D_2 = 0.60 \text{ ft} = \mathbf{7.2 \text{ in}}; \quad (b) n_2 = 28.8 \text{ r/s} = \mathbf{1730 \text{ r/min}}; \quad (c) H_2 = \mathbf{41.9 \text{ ft}}$$


---

**11.38** A 6.85-in pump, running at 3500 rpm, has the measured performance at right for water at 20°C. (a) Estimate the horsepower at BEP. If this pump is rescaled in water to provide 20 bhp at 3000 rpm, determine the appropriate (b) impeller diameter; (c) flow rate; and (d) efficiency for this new condition.

$Q$ , gal/min:	50	100	150	200	250	300	350	400	450
$H$ , ft:	201	200	198	194	189	181	169	156	139
$\eta$ , %:	29	50	64	72	77	80	81	79	74

**Solution:** The BEP of 81% is at about  $Q = 350$  gpm and  $H = 169$  ft. Hence the power is

$$P^* = \frac{\rho g Q^* H^*}{\eta} = \frac{62.4(350/449)(169)}{0.81} = 10150 \frac{\text{ft}\cdot\text{lbf}}{\text{s}} \div 550 \approx \mathbf{18.5 \text{ bhp}} \quad \text{Ans. (a)}$$

If the new conditions are 20 hp at  $n = 3000$  rpm = 50 rps, we equate power coefficients:

$$C_P^* = \frac{10150}{1.94(3500/60)^3(6.85/12)^5} = 0.435 \stackrel{?}{=} \frac{20 \times 550}{1.94(50)^3 D^5},$$

$$\text{Solve } D_{\text{imp}} \approx 0.636 \text{ ft} \approx \mathbf{7.64 \text{ in}} \quad \text{Ans. (b)}$$

With diameter known, the flow rate is computed from BEP flow coefficient:

$$C_Q^* = \frac{Q^*}{nD^3} = \frac{350/449}{(3500/60)(6.85/12)^3} = 0.0719 \stackrel{?}{=} \frac{Q^*}{50(0.636)^3},$$

$$\text{Solve } Q^* = 0.926 \text{ ft}^3/\text{s} \approx \mathbf{415 \text{ gal/min}} \quad \text{Ans. (c)}$$

Finally, since  $D_1 \approx D_2$ , we can assume the same maximum efficiency: **81%**. *Ans. (d)*

---

**11.39** The Allis-Chalmers D30LR centrifugal compressor delivers 33,000 ft<sup>3</sup>/min of SO<sub>2</sub> with a pressure change from 14.0 to 18.0 lbf/in<sup>2</sup> absolute using an 800-hp motor at 3550 r/min. What is the overall efficiency? What will the flow rate and  $\Delta p$  be at 3000 r/min? Estimate the diameter of the impeller.

**Solution:** For  $\text{SO}_2$ , take  $M = 64.06$ , hence  $R = 49720/64.06 \approx 776 \text{ ft}\cdot\text{lbf}/(\text{slug}\cdot^\circ\text{R})$ . Then

$$\Delta p = (18 - 14)(144) = 576 \text{ psf}, \quad \text{Power} = Q\Delta p = 576 \left( \frac{33000}{60} \right) \div 550 \approx 576 \text{ hp delivered}$$

$$\text{Then } \eta = P_{\text{delivered}}/P_{\text{motor}} = 576/800 \approx \mathbf{72\%} \quad \text{Ans. (a)}$$

$$\text{If } n_2 = 3000 \text{ rpm}, \quad Q_2 = Q_1 \left( \frac{n_2}{n_1} \right) = 33000 \left( \frac{3000}{3550} \right) \approx \mathbf{27900} \frac{\text{ft}^3}{\text{min}} \quad \text{Ans. (b)}$$

$$\Delta p_2 = \Delta p_1 (n_2/n_1)^2 = (4 \text{ psi}) \left( \frac{3000}{3550} \right)^2 \approx \mathbf{2.86 \text{ psi}} \quad \text{Ans. (c)}$$

To estimate impeller diameter, we have little to go on except the specific speed:

$$\rho_{\text{avg}} \approx \frac{16(144)}{776(520)} \approx 0.0057 \frac{\text{slug}}{\text{ft}^3}, \quad H = \frac{\Delta p}{\rho g} = \frac{4(144)}{0.0057(32.2)} \approx 3133 \text{ ft},$$

$$N_s = \frac{\text{rpm}(\text{gpm})^{1/2}}{(\text{H-ft})^{3/4}} = \frac{3550[33000(449)/60]^{1/2}}{(3133)^{3/4}} \approx 4212: \quad \text{Fig. P11.49: } C_Q^* \approx 0.45$$

$$\text{Crudely, } C_Q^* \approx 0.45 = \frac{33000/60}{(3550/60)D^3}, \quad \text{solve for } D_{\text{impeller}} \approx \mathbf{2.7 \text{ ft}} \quad \text{Ans. (d)}$$

Clearly this last part depends upon the ingenuity and resourcefulness of the student.

**11.40** The specific speed  $N_s$ , as defined by Eq. (11.30), does not contain the impeller diameter. How then should we size the pump for a given  $N_s$ ? Logan [7] suggests a parameter called the *specific diameter*  $D_s$ , which is a dimensionless combination of  $Q$ ,  $(gH)$ , and  $D$ . (a) If  $D_s$  is proportional to  $D$ , determine its form. (b) What is the relationship, if any, of  $D_s$  to  $C_Q^*$ ,  $C_H^*$ , and  $C_P^*$ ? (c) Estimate  $D_s$  for the two pumps of Figs. 11.8 and 11.13.

**Solution:** If we combine  $C_Q$  and  $C_H$  in such a way as to eliminate speed  $n$ , and also to make the result linearly proportional to  $D$ , we obtain Logan's result:

$$\text{Specific diameter } D_s = \frac{D(gH^*)^{1/4}}{Q^{*1/2}} \quad \text{Ans. (a)} \quad D_s = \frac{C_H^{*1/4}}{C_Q^{*1/2}} \quad \text{Ans. (b)}$$

(c) For the pumps of Figs. 11.8 and 11.13, we obtain

$$D_{s\text{-Fig.11.8}} = \frac{(5.0)^{1/4}}{(0.115)^{1/2}} = \mathbf{4.41}; \quad D_{s\text{-Fig.11.13}} = \frac{(1.07)^{1/4}}{(0.55)^{1/2}} = \mathbf{1.37} \quad \text{Ans. (c)}$$

**11.41** It is desired to build a centrifugal pump geometrically similar to Prob. 11.28 (data at right) to deliver 6500 gal/min of gasoline at 1060 rpm. Estimate the resulting (a) impeller diameter; (b) head; (c) brake horsepower; and (d) maximum efficiency.

$Q$ , ft <sup>3</sup> /s:	0	2	4	6	8	10
$H$ , ft:	340	340	340	330	300	220
bhp:	135	160	205	255	330	330

**Solution:** For gasoline, take  $\rho \approx 1.32$  slug/ft<sup>3</sup>. From Prob. 11.28, BEP occurs at  $Q^* \approx 6$  ft<sup>3</sup>/s,  $\eta_{\max} \approx 0.88$ . The data above are for  $n = 2134$  rpm = 35.6 rps and  $D = 14.62$  in.

$$\text{Then } C_Q^* = \frac{6.0}{35.6(14.62/12)^3} = 0.0933 \stackrel{?}{=} \frac{6500/449}{(1060/60)D^3},$$

Solve for  $D_{\text{imp}} \approx \mathbf{2.06 \text{ ft}}$  *Ans. (a)*

$$C_H^* = \frac{32.2(330)}{(35.6)^2(14.62/12)^2} = 5.66 \stackrel{?}{=} \frac{32.2H}{(1060/60)^2(2.06)^2}, \text{ solve for } H \approx \mathbf{233 \text{ ft}}$$
 *Ans. (b)*

Step-up the efficiency with Moody's correlation, Eq. (11.29a), for  $D_1 = 14.62/12 \approx 1.22$  ft:

$$\frac{1 - \eta_2}{1 - 0.88} \approx \left( \frac{D_1}{D_2} \right)^{1/4} = \left( \frac{1.22}{2.06} \right)^{1/4} = 0.877, \text{ solve for } \eta_2 \approx 0.895$$

$$\text{Then } P_2 = \frac{\rho g Q_2 H_2}{\eta_2} = \frac{1.32(32.2)(6500/449)(233)}{0.895} = 160200 \div 550 \approx \mathbf{290 \text{ bhp}}$$
 *Ans. (c)*

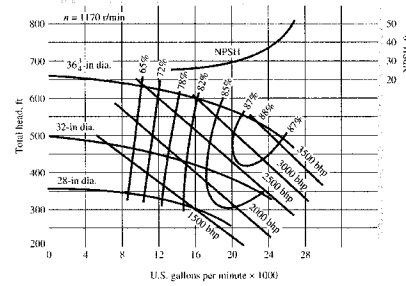
**11.42** An 8-inch model pump delivering water at 180°F at 800 gal/min and 2400 rpm begins to cavitate when the inlet pressure and velocity are 12 psia and 20 ft/s, respectively. Find the required NPSH of a prototype which is 4 times larger and runs at 1000 rpm.

**Solution:** For water at 180°F, take  $\rho g \approx 60.6$  lbf/ft<sup>3</sup> and  $p_v \approx 1600$  psfa. From Eq. 11.19,

$$\text{NPSH}_{\text{model}} = \frac{p_i - p_v}{\rho g} + \frac{V_i^2}{2g} = \frac{12(144) - 1600}{60.6} + \frac{(20)^2}{2(32.2)} = 8.32 \text{ ft}$$

$$\text{Similarity: } \text{NPSH}_{\text{proto}} = \text{NPSH}_m \left( \frac{n_p}{n_m} \right)^2 \left( \frac{D_p}{D_m} \right)^2 = 8.32 \left( \frac{1000}{2400} \right)^2 \left( \frac{4}{1} \right)^2 \approx \mathbf{23 \text{ ft}}$$
 *Ans.*

**11.43** The 28-in-diameter pump in Fig. 11.7a at 1170 r/min is used to pump water at 20°C through a piping system at 14,000 gal/min. (a) Determine the required brake horsepower. The average friction factor is 0.018. (b) If there is 65 ft of 12-in-diameter pipe upstream of the pump, how far below the surface should the pump inlet be placed to avoid cavitation?



**Fig. 11.7a**

**Solution:** For water at 20°F, take  $\rho g \approx 62.4 \text{ lbf/ft}^3$  and  $p_v \approx 49 \text{ psfa}$ . From Fig. 11.7a (above), at 28" and 14000 gpm, read  $H \approx 320 \text{ ft}$ ,  $\eta \approx 0.81$ , and  $P \approx \mathbf{1400 \text{ bhp}}$ . *Ans.*

$$\text{Or: Required bhp} = \frac{\rho g Q H}{\eta} = \frac{(62.4)(14000/449)(320)}{0.81} = 769000 \div 550 \approx \mathbf{1400 \text{ bhp}} \quad \text{Ans.}$$

From the figure, at 14000 gal/min, read  $\text{NPSH} \approx 25 \text{ ft}$ . Assuming  $p_a = 1 \text{ atm} = 2116 \text{ psf}$ ,

$$\text{Eq. 11.20: } \text{NPSH} = \frac{p_a - p_v}{\rho g} - Z_i - h_{fi} = \frac{2116 - 49}{62.4} - Z_i - h_{fi} \approx 25 \text{ ft}, \quad h_{fi} = f \frac{L}{D} \frac{V^2}{2g},$$

$$V = \frac{Q}{A} = \frac{14000/449}{(\pi/4)(1 \text{ ft})^2} \approx 39.7 \frac{\text{ft}}{\text{s}},$$

$$\text{so: } Z_i = 33.1 - 25 - 0.018 \left( \frac{65}{1} \right) \left[ \frac{(39.7)^2}{2(32.2)} \right] \approx \mathbf{-21 \text{ ft}} \quad \text{Ans.}$$

**11.44** The pump of Prob. 11.28 is scaled up to an 18-in-diameter, operating in water at BEP at 1760 rpm. The measured NPSH is 16 ft, and the friction loss between the inlet and the pump is 22 ft. Will it be sufficient to avoid cavitation if the pump inlet is placed 9 ft below the surface of a sea-level reservoir?

**Solution:** For water at 20°C, take  $\rho g = 62.4 \text{ lbf/ft}^3$  and  $p_v = 49 \text{ psfa}$ . Since the NPSH is given, there is no need to use the similarity laws. Merely apply Eq. 11.20:

$$\text{NPSH} \leq \frac{p_a - p_v}{\rho g} - Z_i - h_{fi}, \quad \text{or: } Z_i \leq \frac{2116 - 49}{62.4} - 22 - 16 = -4.9 \text{ ft, } \mathbf{OK},$$

$$\mathbf{Z_{actual} = -9 \text{ ft}} \quad \text{Ans.}$$

This works. Putting the inlet 9 ft below the surface gives 4 ft of margin against cavitation.



**11.45** Determine the specific speeds of the seven Taco, Inc. pump impellers in Fig. P11.24. Are they appropriate for centrifugal designs? Are they approximately equal within experimental uncertainty? If not, why not?

**Solution:** Read the BEP values for each impeller and make a little table for 1160 rpm:

D, inches:	10.0	10.5	11.0	11.5	12.0	12.5	12.95
Q*, gal/min:	390	420	440	460	480	510	530
H*, ft:	41	44	49	56	60	66	72
Specific speed $N_s$ :	<b>1414</b>	<b>1392</b>	<b>1314</b>	<b>1215</b>	<b>1179</b>	<b>1131</b>	<b>1080</b>

These are well within the centrifugal-pump range ( $N_s < 4000$ ) but they are not equal because they are not geometrically similar (7 different impellers within a single housing). *Ans.*

**11.46** The answer to Prob. 11.40 is that the dimensionless “specific diameter” takes the form  $D_s = D(gH^*)^{1/4}/Q^{*1/2}$ , evaluated at the BEP. Data collected by the writer for 30 different pumps indicates, in Fig. P11.46, that  $D_s$  correlates well with specific speed  $N_s$ . Use this figure to estimate the appropriate impeller diameter for a pump which delivers 20,000 gal/min of water and a head of 400 ft running at 1200 rev/min. Suggest a curve-fit formula to the data (*Hint: a hyperbola*).

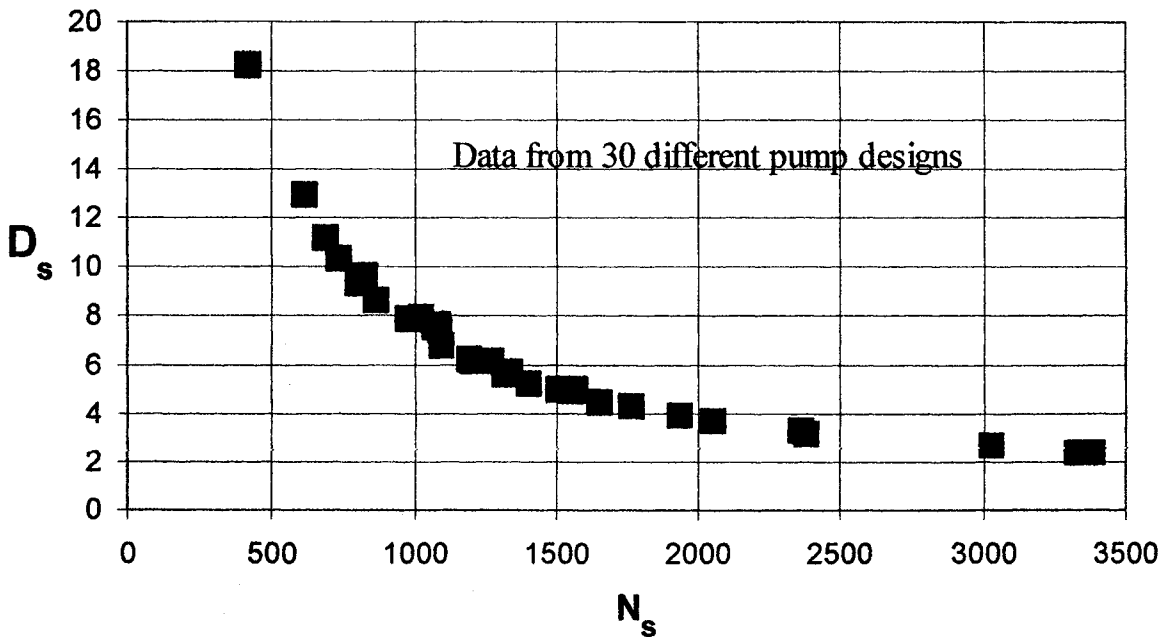


Fig. P11.46

**Solution:** We see that the data are very well correlated by a single curve. (NOTE: These are all *centrifugal* pumps—a slightly different correlation holds for mixed- and axial-flow pumps.) The data are well fit by a hyperbola:

$$\text{Figure P11.46: } D_s \approx \frac{\text{Const}}{N_s}, \text{ where Const} \approx 7800 \pm 300 \text{ Ans.}$$

For the given pump-data example, we compute

$$N_s = \frac{(\text{rpm})(\text{gal/min})^{1/2}}{(\text{Head-ft})^{3/4}} = \frac{1200(20000)^{1/2}}{(400)^{3/4}} = 1897,$$

$$\text{Hence } D_s \approx \frac{7800}{1897} \approx 4.11 = \frac{D[32.2(400)]^{1/4}}{(20000/448.83)^{1/2}}, \text{ solve } D \approx \mathbf{2.6 \pm 0.1 \text{ ft}} \text{ Ans.}$$

**11.47** A typical household basement sump pump provides a discharge of 5 gal/min against a head of 15 ft. Estimate (a) the maximum efficiency; and (b) the minimum horsepower required to drive such a pump.

**Solution:** Typical small sump pumps run at about 1750 rpm, so we can estimate:

$$N_s = \frac{(\text{rpm})(\text{gal/min})^{1/2}}{(\text{head})^{3/4}} \approx \frac{1750(5)^{1/2}}{(15 \text{ ft})^{3/4}} \approx 513. \text{ Fig. 11.14: read } \eta_{\max} \approx \mathbf{0.27} \text{ Ans. (a)}$$

$$\text{Then } P_{\min} = \frac{\rho g Q H}{\eta_{\max}} = \frac{62.4(5/449)(15)}{0.27} = 39 \div 550 \approx \mathbf{0.07 \text{ bhp}} \text{ Ans. (b)}$$

**11.48** When operating at 42 r/s near BEP, a pump delivers 0.06 m<sup>3</sup>/s against a head of 100 m. (a) What is its specific speed? (b) What kind of pump is this likely to be? (c) Estimate its impeller diameter.

**Solution:** (a) We have to go English to calculate the traditional specific speed. Convert  $Q = 0.06 \text{ m}^3/\text{s} = 951 \text{ gal/min}$ ,  $H = 100 \text{ m} = 328 \text{ ft}$ , and  $n = 42 \text{ r/s} = 2520 \text{ r/min}$ . Then

$$N_s = \frac{\text{rpm}(\text{gal/min})^{1/2}}{(\text{Head in ft})^{3/4}} = \frac{2520(951)^{1/2}}{(328)^{3/4}} \approx \mathbf{1000} \text{ Ans. (a)}$$

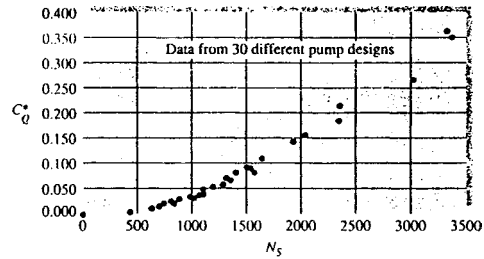
(b) This specific speed is characteristic of a **centrifugal pump**. Ans. (b)

(c) From Prob. 11.46, the dimensionless specific diameter  $D_s = D(gH^*)^{1/4}/Q^{*1/2}$  is closely correlated with specific speed:

$$D_s \approx \frac{7800}{N_s} = \frac{7800}{1000} = 7.8 = \frac{D[9.81 \text{ m/s}^2(100 \text{ m})]^{1/4}}{(0.06 \text{ m}^3/\text{s})^{1/2}}$$

Solve for **D ≈ 0.34 m (13 in)** Ans. (c)

**11.49** Data collected by the writer for flow coefficient at BEP for 30 different pumps are plotted at right in Fig. P11.49. Determine if the values of  $C_Q^*$  fit this correlation for the pumps of Problems P11.24, P11.28, P11.35, and P11.38. If so, suggest a curve fit formula.



**Fig. P11.49** Flow coefficient at BEP for 30 commercial pumps.

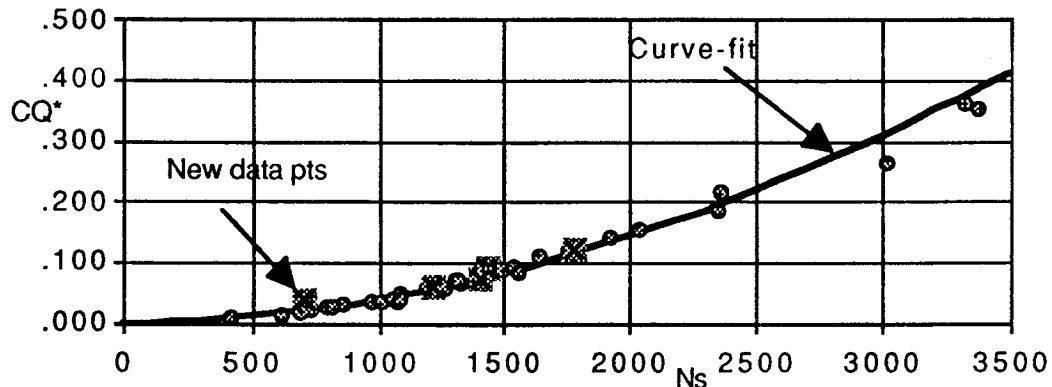
**Solution:** Make a table of these values:

	$Q^*$ , gpm	D, inches	n, rpm	$N_s$	$C_Q^* = Q^*/(nD^3)$
Prob. 11.28:	2692	14.62	2134	<b>1430</b>	0.0933
Prob. 11.35:	37	5.0	1800	<b>700</b>	0.0384
Prob. 11.38:	350	6.85	3500	<b>1400</b>	0.0719
Fig. P11.24:	460	11.5	1160	<b>1215</b>	0.0602 Ans.

When added to the plot shown below, all four seem to fit quite well, although the ‘suspect’ data point #2 (taken from Prob. 11.35) is rather high (about 75%). The data are useful for predicting general centrifugal-pump behavior and are well fit to either a 2nd-order polynomial or a single-term Power-law slightly less than parabolic:

Polynomial:  $C_Q^* \approx 1.97E-5N_s + 2.58E-8N_s^2$  (Correlation  $R^2 \approx 0.99$ ) Ans.

Power-law:  $C_Q^* \approx 6.83E-8N_s^{1.914}$



**11.50** Data collected by the writer for power coefficient at BEP for 30 different pumps are plotted at right in Fig. P11.50. Determine if the values of  $C_P^*$  for the FOUR pumps of Prob. 11.49 above fit this correlation.

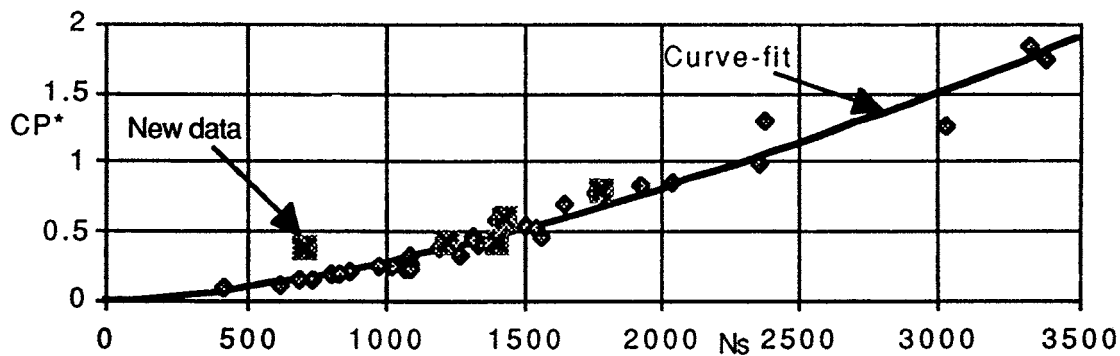
**Solution:** Make a table of these values, similar to Prob. 11.50:

	$P^*$ , bhp	D, inches	$n$ , rpm	$N_s$	$C_P^* = P^*/(\rho n^3 D^5)$
Prob. 11.28:	255	14.62	2134	<b>1430</b>	0.600
Prob. 11.35:	0.46	5.0	1800	<b>700</b>	0.386
Prob. 11.38:	18.5	6.85	3500	<b>1400</b>	0.435
Fig. P11.24:	8.7	11.5	1160	<b>1215</b>	0.421 Ans.

When added to the plot shown below, three of them seem to fit reasonably well, but the 'suspect' data point #2 (from Prob. 11.35) is rather high (>100%). The data are moderately useful for predicting general centrifugal-pump behavior and can be fit to either a 2nd-order polynomial or a single-term Power-law:

Polynomial:  $C_P^* \approx 2.12E-4N_s + 9.5E-8N_s^2$  (poorer correlation,  $R^2 \approx 0.96$ ) Ans.

Power-law:  $C_P^* \approx 6.78E-6N_s^{1.537}$



**Fig. P11.50** Power coefficient at BEP for 30 commercial pumps.

**11.51** An axial-flow pump delivers  $40 \text{ ft}^3/\text{s}$  of air which enters at  $20^\circ\text{C}$  and 1 atm. The flow passage has a 10-in outer radius and an 8-in inner radius. Blade angles are  $\alpha_1 = 60^\circ$  and  $\beta_2 = 70^\circ$ , and the rotor runs at 1800 rpm. For the first stage, compute (a) the head rise; and (b) the power required.

**Solution:** Assume an average radius of  $(8 + 10)/2 = 9$  inches and compute the blade speed:

$$u_{\text{avg}} = \omega r_{\text{avg}} = \left(1800 \frac{2\pi}{60}\right) \left(\frac{9}{12}\right) \approx 141 \frac{\text{ft}}{\text{s}}; \quad V_n = \frac{Q}{A} = \frac{40 \text{ ft}^3/\text{s}}{\pi[(10/12)^2 - (8/12)^2]} \approx 50.9 \frac{\text{ft}}{\text{s}}$$

$$\text{Theory: } gH = u^2 - uV_n(\cot \alpha_1 + \cot \beta_2) = (141)^2 - 141(50.9)(\cot 60^\circ + \cot 70^\circ),$$

$$\mathbf{H \approx 410 \text{ ft} \quad \text{Ans. (a)}}$$

$$P_{\text{theory}} = \rho gQH = \left[\frac{2116}{1717(528)}\right] (32.2)(40)(410) = 1232 \div 550 \approx \mathbf{2.24 \text{ hp} \quad \text{Ans. (b)}}$$

**11.52** An axial-flow fan operates in sea-level air at 1200 r/min and has a blade-tip diameter of 1 m and a root diameter of 80 cm. The inlet angles are  $\alpha_1 = 55^\circ$  and  $\beta_1 = 30^\circ$ , while at the outlet  $\beta_2 = 60^\circ$ . Estimate the theoretical values of the (a) flow rate, (b) horse-power, and (c) outlet angle  $\alpha_2$ .

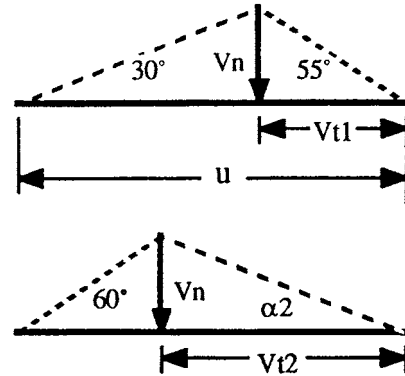


Fig. P11.52

**Solution:** For air, take  $\rho \approx 1.205 \text{ kg/m}^3$ . The average radius is 0.45 m. Thus

$$u = \omega R = \left(1200 \frac{2\pi}{60}\right) (0.45) \approx 56.6 \frac{\text{m}}{\text{s}} = V_n(\cot \alpha_1 + \cot \beta_1) = V_{n2}(\cot \alpha_2 + \cot \beta_2)$$

$$\text{Solve } V_{n1} = V_{n2} = \frac{56.6}{\cot 55^\circ + \cot 30^\circ} \approx 23.2 \frac{\text{m}}{\text{s}} \quad \text{and} \quad \alpha_2 \approx \mathbf{28.3^\circ} \quad \text{Ans. (c)}$$

$$\text{Then } Q = V_n A = (23.2)[\pi\{(0.5)^2 - (0.4)^2\}] \approx \mathbf{6.56 \frac{\text{m}^3}{\text{s}}} \quad \text{Ans. (a)}$$

$$gH = u^2 - uV_n(\cot \alpha_1 + \cot \beta_2) = (56.6)^2 - 56.6(23.2)(\cot 55^\circ + \cot 60^\circ) = 1520 \text{ m}^2/\text{s}^2$$

$$\text{Finally, } \mathbf{P = \rho QgH = 1.205(6.56)(1520) = 12,000 \text{ W} \quad \text{Ans. (b)}}$$

**11.53** If the axial-flow pump of Fig. 11.13 is used to deliver 70,000 gal/min of 20°C water at 1170 rpm, estimate (a) the proper impeller diameter; (b) the shut-off head; (c) the shut-off horsepower; and (d)  $\Delta p$  at best efficiency.

**Solution:** From Fig. 11.13, read  $C_Q^* \approx 0.55$ ,  $C_H^* \approx 1.07$ ,  $C_P^* \approx 0.70$ , and  $\eta_{\max} \approx 0.84$ .

$$C_Q^* = 0.55 = \frac{Q^*}{nD^3} = \frac{70000/449}{(1170/60)D^3}, \quad \text{solve for } D_{\text{impeller}} \approx \mathbf{2.44 \text{ ft}} \quad \text{Ans. (a)}$$

Also read  $C_{H_0}(\text{shut-off}) \approx 2.85 = \frac{(32.2)H_0}{(1170/60)^2(2.44)^2}$ , solve  $H_{\text{shutoff}} \approx \mathbf{200 \text{ ft}}$  Ans. (b)

$$\text{Read } C_{P_0}(\text{shutoff}) \approx 1.2, P_0 = 1.2(1.94)\left(\frac{1170}{60}\right)^3(2.44)^5$$

$$C_{P_0} = 1.5E6 \div 550 \approx \mathbf{2700 \text{ hp}} \quad \text{Ans. (c)}$$

$$\text{Finally, } \Delta p^* = \rho g H^* = 62.4 \left[ 1.07 \frac{(1170/60)^2(2.44)^2}{32.2} \right] \approx 4697 \div 144 \approx \mathbf{33 \text{ psi}} \quad \text{Ans. (d)}$$

**11.54** The Colorado River Aqueduct uses Worthington Corp. pumps which deliver  $200 \text{ ft}^3/\text{s}$  of water at 450 rpm against a head of 440 ft. What kind of pumps are these? Estimate the impeller diameter.

**Solution:** Evaluate the specific speed to see what type of pumps we have:

$$N_s = \frac{(\text{rpm})(\text{gal}/\text{min})^{1/2}}{(\text{head})^{3/4}} = \frac{450(200 \times 449)^{1/2}}{(440)^{3/4}} \approx 1400 \quad \therefore \mathbf{\text{Centrifugal pumps}} \quad \text{Ans. (a)}$$

To estimate the diameter, use the curve-fit to the correlation we had in Fig. P11.50:

$$C_Q^* \approx (6.83E-8)(1400)^{1.914} \approx 0.072 = \frac{200}{(450/60)D^3}, \quad \text{solve } D_{\text{impeller}} \approx \mathbf{7.2 \text{ ft}} \quad \text{Ans. (b)}$$

**11.55** We want to pump  $70^\circ\text{C}$  water at 20,000 gal/min and 1800 rpm. Estimate the type of pump needed, the horsepower required, and the impeller diameter if the required pressure rise for one stage is (a) 170 kPa; and (b) 1350 kPa.

**Solution:** For water to  $70^\circ\text{C}$ , take  $\rho \approx 978 \text{ kg}/\text{m}^3$ . Evaluate the specific speed:

$$\text{(a) } \Delta p = 170 \text{ kPa}, \quad H = \frac{\Delta p}{\rho g} = \frac{170000}{978(9.81)} = 17.7 \text{ m} \approx 58 \text{ ft} \quad N_s = \frac{(1800)(20000)^{1/2}}{(58)^{3/4}} \approx 12090$$

$\therefore$  Need **axial-flow pump** ( $\eta \approx 0.900$ ) Ans. (a)

$$\text{Then } P = \rho g Q H / \eta = \left( \frac{978}{515} \right) (32.2) \left( \frac{20000}{449} \right) (58) / 0.9 = 175500 \div 550 \approx \mathbf{320 \text{ hp}} \quad \text{Ans. (a)}$$

$$\text{Fig. 11.13 } (N_s \approx 12000): C_Q^* \approx 0.55 = \frac{20000/449}{(1800/60)D^3}, \text{ solve } D_{\text{impeller}} \approx \mathbf{1.4 \text{ ft}} \quad \text{Ans. (a)}$$

$$\text{(b) } \Delta p = 1350, H = \frac{1,350,000}{978(9.81)} = 141 \text{ m} \approx 462 \text{ ft}, N_s = \frac{1800(20000)^{1/2}}{(462)^{3/4}} \approx 2560$$

**Centrifugal pump,  $\eta \approx 0.92$**  Ans. (b)

$$P = (1.9)(32.2)(20000/449)(462)/0.92 = 1.37E6 \div 550 \approx \mathbf{2500 \text{ hp}} \quad \text{Ans. (b)}$$

$$\text{Fig. P11.49: } C_Q^* \approx 0.23 = \frac{20000/449}{(1800/60)D^3}, \text{ solve } D_{\text{impeller}} \approx \mathbf{1.9 \text{ ft}} \quad \text{Ans. (b)}$$

**11.56** A pump is needed to deliver 40,000 gpm of gasoline at 20°C against a head of 90 ft. Find the impeller size, speed, and brake horsepower needed to use the pump families of (a) Fig. 11.8; and (b) Fig. 11.13. Which is the better design?

**Solution:** For gasoline, take  $\rho \approx 1.32 \text{ slug/ft}^3$ .

$$\text{(a) For the centrifugal design, } C_Q^* \approx 0.115 = \frac{40000/449}{nD^3} \quad \text{and} \quad C_H^* \approx 5.0 = \frac{32.2(90)}{n^2 D^2},$$

$$\text{Solve for } n \approx 4.24 \text{ rps} \approx \mathbf{255 \text{ rpm}} \quad \text{and} \quad D_{\text{impeller}} \approx \mathbf{5.67 \text{ ft}} \quad \text{Ans. (a)}$$

$$P^* = C_P^* \rho n^3 D^5 = 0.65(1.32)(4.24)^3(5.67)^5 \div 550 \approx \mathbf{700 \text{ bhp}} \quad \text{Ans. (a)}$$

(b) For the axial-flow design, Fig. 11.13,

$$C_Q^* = 0.55 = \frac{40000/449}{nD^3}, \quad C_H^* = 1.07 = \frac{32.2(90)}{n^2 D^2}$$

$$\text{or: } n \approx \mathbf{1770 \text{ rpm}}, \quad D \approx \mathbf{1.76 \text{ ft}} \quad \text{Ans. (b)}$$

$$P^* = C_P^* \rho n^3 D^3 = 0.70(1.32)(29.5)^3(1.76)^5 \div 550 \approx \mathbf{740 \text{ bhp}} \quad \text{Ans. (b)}$$

The **axial-flow design (b)** is far better for this system: smaller and faster. Ans.

**11.57** Performance data for a 21-in-diameter air blower running at 3550 rpm are shown below. What is the specific speed? How does the performance compare with Fig. 11.13? What are  $C_Q^*$ ,  $C_H^*$ ,  $C_P^*$ ?

$\Delta p$ , in H <sub>2</sub> O:	29	30	28	21	10
$Q$ , ft <sup>3</sup> /min:	500	1000	2000	3000	4000
bhp:	6	8	12	18	25

**Solution:** Assume 1-atm air,  $\rho \approx 0.00233$  slug/ft<sup>3</sup>. Convert the data to dimensionless form and put the results into a table:

$\Delta p$ , psf:	151	156	146	109	52
$Q$ , ft <sup>3</sup> /min:	500	1000	2000	3000	4000
$Q$ , gal/min:	3740	7480	14960	22440	29920
$H$ , ft (of air):	2010	2080	1940	1455	693
$C_Q$ :	0.0263	0.0526	<b>0.105</b>	0.158	0.210
$C_H$ :	6.04	6.25	<b>5.83</b>	4.37	2.08
$C_P$ :	0.417	0.555	<b>0.833</b>	1.25	1.74
$\eta$ :	0.381	0.592	<b>0.735</b>	0.552	0.251

Close enough without plotting:  $C_Q^* \approx \mathbf{0.105}$ ,  $C_H^* \approx \mathbf{5.83}$ ,  $C_P^* \approx \mathbf{0.833}$  *Ans.*

$$\text{Specific speed } N_s = \frac{(3550 \text{ rpm})(14960 \text{ gpm})^{1/2}}{(1940 \text{ ft})^{3/4}} \approx \mathbf{1485} \quad \text{Ans.}$$

This centrifugal pump is **very similar** to the dimensionless data of **Fig. 11.8**. *Ans.*

**11.58** The Worthington Corp. Model A-12251 water pump, operating at maximum efficiency, produces 53 ft of head at 3500 rpm, 1.1 bhp at 3200 rpm, and 60 gal/min at 2940 rpm. What type of pump is this? What is its efficiency, and how does this compare with Fig. 11.14? Estimate the impeller diameter.

**Solution:** We can convert the power and flow-rate values to 3500 rpm with similarity:

$$P_{3500}^* \approx (1.1) \left( \frac{3500}{3200} \right)^3 \approx 1.44 \text{ bhp}; \quad Q_{3500}^* \approx (60) \left( \frac{3500}{2940} \right) \approx 71.4 \text{ gal/min}$$

$$\text{Then } N_s = \frac{(3500)(71.4)^{1/2}}{(53)^{3/4}} \approx \mathbf{1510} \quad \text{Centrifugal pump.} \quad \text{Ans.}$$

$$\eta_{\max} = \frac{\rho g Q H}{P} = \frac{62.4(71.4/449)(53)}{1.44(550)} \approx \mathbf{66.5\%} \quad (\text{compares well with Fig. 11.14}) \quad \text{Ans.}$$



Fig. P11.49:  $C_Q^* \approx 0.085 = \frac{71.4/449}{(3500/60)D^3}$  solve for  $D_{\text{impeller}} \approx \mathbf{0.32 \text{ ft}}$  (4 in) *Ans.*

---

**11.59** Suppose it is desired to deliver 700 ft<sup>3</sup>/min of propane gas (molecular weight = 44.06) at 1 atm and 20°C with a single-stage pressure rise of 8.0 in H<sub>2</sub>O. Determine the appropriate size and speed for using the pump families of (a) Prob. 11.57 and (b) Fig. 11.13. Which is the better design?

**Solution:** For propane, with  $M = 44.06$ , the gas constant  $R = 49720/44.06 \approx 1128 \text{ ft}\cdot\text{lb}/(\text{slug}\cdot^\circ\text{R})$ . Convert  $\Delta p = 8 \text{ inH}_2\text{O} = (62.4)(8/12) = 41.6 \text{ psf}$ . The propane density and head rise are

$$\rho_{\text{gas}} = \frac{p}{RT} = \frac{2116 \text{ psf}}{1128(528)} \approx 0.00355 \frac{\text{slug}}{\text{ft}^3},$$

$$\text{Hence } H_{\text{pump}} = \frac{41.6}{0.00355(32.2)} \approx 364 \text{ ft propane}$$

(a) Prob. 11.57:  $C_Q^* \approx 0.105 = \frac{700/60}{nD^3}$  and  $C_H^* \approx 5.83 = \frac{32.2(364)}{n^2 D^2}$

Solve for  $n = 28.5 \text{ rps} \approx \mathbf{1710 \text{ rpm}}$  and  $D \approx \mathbf{1.57 \text{ ft}}$  *Ans.* (a) (centrifugal pump)

(b) Fig. 11.13:  $C_Q^* \approx 0.55$  and  $C_H^* \approx 1.07$  yield

$$n \approx \mathbf{14000 \text{ rpm}}, \quad D \approx \mathbf{0.45 \text{ ft}} \quad \textit{Ans.} \text{ (b) (axial flow)}$$

The **centrifugal pump (a)** is the better design—nice size, nice speed. The axial flow pump is much smaller but runs too fast. *Ans.*

---

**11.60** A 45-hp pump is desired to generate a head of 200 ft when running at BEP with 20°C gasoline at 1200 rpm. Using the correlations in Figs. P11.49 and P11.50, determine the appropriate (a) specific speed; (b) flow rate; and (c) impeller diameter.

**Solution:** For gasoline, take  $\rho \approx 1.32 \text{ slug}/\text{ft}^3$ . The two correlations from Problems 11.49 and 11.50 are

$$\frac{Q}{nD^3} \approx 6.83\text{E}-8 N_s^{1.914} \quad \text{and} \quad \frac{P}{\rho n^3 D^5} \approx 6.78\text{E}-6 N_s^{1.537} \quad \text{where } N_s = \frac{(\text{rpm})(\text{gal}/\text{min})^{1/2}}{(\text{head})^{3/4}}$$

With  $n$ ,  $\rho$ ,  $P$ , and  $H$  known, the unknowns are the flow rate  $Q$  and diameter  $D$ . Not seeing exactly how to resolve this analytically, the writer simply ran a computer program for various diameters until the flow rates were the same for both correlations. Finally,

$$N_s \approx \mathbf{623} \quad \text{Ans. (a)} \quad Q \approx \mathbf{762 \text{ gal/min}} \quad \text{Ans. (b)} \quad D \approx \mathbf{1.77 \text{ ft}} \quad \text{Ans. (c)}$$

**11.61** A mine ventilation fan delivers  $500 \text{ m}^3/\text{s}$  of sea-level air at 295 rpm and  $\Delta p = 1100 \text{ Pa}$ . Is this fan axial, centrifugal, or mixed? Estimate its diameter in feet. If the flow rate is increased 50% for the same diameter, by what percent will  $\Delta p$  change?

**Solution:** For sea-level air, take  $\rho g \approx 11.8 \text{ N/m}^3$ , hence  $H = \Delta p / \rho g = 1100 / 11.8 \approx 93 \text{ m} \approx 305 \text{ ft}$ . Convert  $500 \text{ m}^3/\text{s}$  to  $7.93\text{E}6 \text{ gal/min}$  and calculate the specific speed:

$$N_s = \frac{\text{rpm}(\text{gal/min})^{1/2}}{(\text{head})^{3/4}} = \frac{295(7.93\text{E}6)^{1/2}}{(305)^{3/4}} \approx \mathbf{11400 \text{ (axial-flow pump)}} \quad \text{Ans. (a)}$$

$$\text{Estimate } C_Q^* \approx 0.55 = \frac{500 \text{ m}^3/\text{s}}{(295/60)D^3}, \quad \text{solve } D_{\text{impeller}} \approx 5.7 \text{ m} \approx \mathbf{19 \text{ ft}} \quad \text{Ans. (b)}$$

At constant  $D$ ,  $Q \propto n$  and  $\Delta p$  (or  $H$ )  $\propto n^2$ . Therefore, if  $Q$  increases 50%, so does  $n$ , and therefore  $\Delta p$  increases as  $(1.5)^2 = 2.25$ , or a **125% increase**. *Ans. (c)*

**11.62** The actual mine-ventilation fan in Prob. 11.61 had a diameter of 20 ft [Ref. 20, p. 339]. What would be the proper diameter for the pump family of Fig. 11.14 to provide  $500 \text{ m}^3/\text{s}$  at 295 rpm and BEP? What would be the resulting pressure rise in Pa?

**Solution:** For sea-level air, take  $\rho g \approx 11.8 \text{ N/m}^3$ . As in Prob. 11.61 above, the specific speed of this fan is **11400**, hence an *axial-flow* fan. Figure 11.14 indicates an efficiency of about 90%, and the only values we know for performance are from Fig. 11.13:

$$N_s \approx 12000: C_Q^* \approx 0.55 = \frac{500}{(295/60)D^3}, \quad \text{solve } D_{\text{impeller}} \approx 5.7 \text{ m} \approx \mathbf{18.7 \text{ ft}} \quad \text{Ans. (a)}$$

$$C_H^* \approx 1.07, \quad H = 1.07 \frac{(295/60)^2 (20 \times 0.3048)^2}{9.81} = 98 \text{ m},$$

$$\Delta p = (11.8)(98) \approx \mathbf{1160 \text{ Pa}} \quad \text{Ans. (b)}$$

**11.63** The 36.75-in pump in Fig. 11.7a at 1170 r/min is used to pump water at 60°F from a reservoir through 1000 ft of 12-in-ID galvanized-iron pipe to a point 200 ft above the reservoir surface. What flow rate and brake horsepower will result? If there is 40 ft of pipe upstream of the pump, how far below the surface should the pump inlet be placed to avoid cavitation?

**Solution:** For galvanized pipe,  $\varepsilon \approx 0.0005$  ft, hence  $\varepsilon/d \approx 0.0005$ . Assume fully-rough flow, with  $f \approx 0.0167$ . The pipe head loss is thus approximately

$$h_f = \Delta z + f \frac{L}{d} \frac{[Q/(\pi d^2/4)]^2}{2g} = 200 + 0.0167 \left( \frac{1000}{1} \right) \frac{[Q/(\pi(1)^2/4)]^2}{2(32.2)}$$

$$\approx 200 + 0.42Q^2 \quad (Q \text{ in ft}^3/\text{s})$$

Curve-fit Fig. 11.7a,  $D = 36.75''$ , to a parabola:  $H_p \approx 665 - 0.051Q^2$  (again  $Q$  in  $\text{ft}^3/\text{s}$ )

Equate:  $665 - 0.051Q^2 = 200 + 0.42Q^2$ , solve  $Q \approx 31.4 \text{ ft}^3/\text{s} \approx \mathbf{14100 \text{ gpm}}$  *Ans.* (a)

Figure 11.7a:  $P = \rho g Q H / \eta = 62.4(31.4)(615) / 0.78 \div 550 \approx \mathbf{2800 \text{ bhp}}$ . *Ans.* (b)

Check  $V = Q/A \approx 40 \text{ ft/s}$ ,  $Re_d = Vd/\nu \approx 3.71E6$ , Moody chart,  $f \approx \mathbf{0.0168}$  (OK).

(c) Figure 11.7a @ 14000 gpm: read  $NPSH \approx \mathbf{25 \text{ ft}}$ . Calculate the head loss upstream:

$$h_{fi} = f \frac{L}{d} \frac{V^2}{2g} = 0.0168 \left( \frac{40}{1} \right) \frac{(40.0)^2}{2(32.2)} \approx 16.7 \text{ ft}, \text{ use Eq. 11.20:}$$

$$NPSH = 25 \leq \frac{P_a - P_v}{\rho g} - Z_i - h_{fi} = \frac{2116 - 39}{62.4} - Z_i - 16.7, \text{ solve } Z_i \leq \mathbf{-8.5 \text{ ft}}$$
 *Ans.* (c)

**11.64** A leaf blower is essentially a centrifugal impeller exiting to a tube. Suppose that the tube is smooth PVC pipe, 4 ft long, with a diameter of 2.5 in. The desired exit velocity is 73 mi/h in sea-level standard air. If we use the pump family of Eq. (11.27) to drive the blower, what approximate (a) diameter and (b) rotation speed are appropriate? (c) Is this a good design?

**Solution:** Recall that Eq. (11.27) gave BEP coefficients for the pumps of Fig. 11.7:

$$C_Q^* \approx 0.115; \quad C_H^* \approx 5.0; \quad C_P^* \approx 0.65$$

Apply these coefficients to the leaf-blower data. Neglect minor losses, that is, let the pump head match the pipe friction loss. For air, take  $\rho = 1.2 \text{ kg/m}^3$  and  $\mu = 1.8E-5 \text{ kg/m}\cdot\text{s}$ .

Convert 73 mi/h = 32.6 m/s, 4 ft = 1.22 m and 2.5 in = 0.0635 m:

$$h_f = H_{pump} = 5.0 \frac{n^2 D^2}{9.81 \text{ m/s}^2} = f \frac{L}{d_{pipe}} \frac{V_{pipe}^2}{2g} = f \left( \frac{1.22 \text{ m}}{0.0635 \text{ m}} \right) \left[ \frac{(32.6 \text{ m/s})^2}{2(9.81 \text{ m/s}^2)} \right], \quad f = f(\text{Re}_d)$$

$$Q = \frac{\pi}{4} d_{pipe}^2 V = \frac{\pi}{4} (0.0635 \text{ m})^2 (32.6 \text{ m/s}) = 0.103 \frac{\text{m}^3}{\text{s}} = \mathbf{0.115 n D^3}$$

We know the Reynolds number,  $\text{Re}_d = \rho V d / \mu = (1.2)(32.6)(0.0635)/(1.8\text{E-}5) = 138,000$ , and for a smooth pipe, from the Moody chart, calculate  $f_{\text{smooth}} = 0.0168$ . Then  $H = h_f = 17.5 \text{ m}$ , and the two previous equations can then be solved for

$$D_{\text{pump}} \approx \mathbf{0.39 \text{ m}} \text{ (15.4 in); } \quad n \approx 15 \text{ r/s} = \mathbf{900 \text{ r/min}} \quad \text{Ans. (a, b)}$$

(c) This blower is **too slow and too large**, a better (mixed or axial flow) pump can be designed. *Ans. (c)*

**11.65** The 38-inch pump in Fig. 11.7b is used in *series* to lift 20°C water 3000 ft through 4000-ft of 18-inch-diameter cast iron pipe. For most efficient operation, how many pumps in series are needed if the rotation speed is (a) 710 rpm; and (b) 1200 rpm?

**Solution:** (a) At BEP in Fig. 11.7b,  $D = 38''$ ,  $n = 710 \text{ rpm}$ , read  $H^* \approx 225 \text{ ft}$  and  $Q^* \approx 20000 \text{ gpm} = 44.6 \text{ ft}^3/\text{s}$ . Take  $\epsilon = 0.00085 \text{ ft}$ . Evaluate the system-head loss at BEP flow:

$$V = \frac{44.6}{(\pi/4)(1.5)^2} \approx 25.2 \frac{\text{ft}}{\text{s}}, \quad \text{Re}_d = \frac{Vd}{\nu} = \frac{25.2(1.5)}{1.08\text{E-}5} \approx 3.51\text{E}6,$$

$$\frac{\epsilon}{d} = \frac{0.00085}{1.5}, \quad f \approx \mathbf{0.0173}$$

$$\text{Then } h_{\text{system}} = \Delta z + f \frac{L}{d} \frac{V^2}{2g} = 3000 + 0.0173 \left( \frac{4000}{1.5} \right) \frac{(25.2)^2}{2(32.2)} = 3000 + 456 \approx 3456 \text{ ft}$$

Since each pump provides 225 ft, we need  $3456/225 \approx \mathbf{15 \text{ pumps}}$  @ 710 rpm. *Ans. (a)*

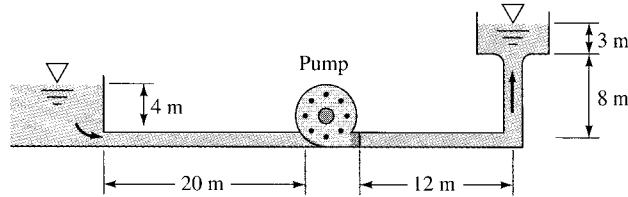
(b) If we increase the speed to 1200 rpm at constant diameter, both  $H^*$  and  $Q^*$  change:

$$H^* = 225 \left( \frac{1200}{710} \right)^2 \approx 643 \text{ ft}, \quad Q^* = 44.6 \left( \frac{1200}{710} \right) \approx 75.3 \frac{\text{ft}^3}{\text{s}},$$

$$V = 42.6 \frac{\text{ft}}{\text{s}}, \quad \text{Re}_d \approx 5.92\text{E}6,$$

$$\text{Read } f \approx 0.0237, \quad h_{\text{syst}} = \Delta z + f \frac{L V^2}{d 2g} \approx 4785 \text{ ft} \div 645 \frac{\text{ft}}{\text{pump}} \\ \approx \mathbf{8 \text{ pumps}} \text{ needed } \textit{Ans. (b)}$$

**11.66** It is proposed to run the pump of Prob. 11.35 at 880 rpm to pump water at 20°C through the system of Fig. P11.66. The pipe is 20-cm diameter commercial steel. What flow rate in ft<sup>3</sup>/min results? Is this an efficient operation?



**Fig. P11.66**

**Solution:** For water, take  $\rho = 998 \text{ kg/m}^3$  and  $\mu = 0.001 \text{ kg/m}\cdot\text{s}$ . For commercial steel, take  $\varepsilon = 0.046 \text{ mm}$ . Write the energy equation for the system:

$$H_{\text{pump}} = \Delta z + f \frac{L V^2}{d 2g} = 11 - 4 + f \frac{40 [Q/(\pi(0.2)^2/4)]^2}{0.2 \cdot 2(9.81)} = 7 + 10328fQ^2, \quad \left( Q \text{ in } \frac{\text{m}^3}{\text{s}} \right)$$

$$\text{Meanwhile, } H_p = fcn(Q)_{\text{Prob. 11.35}} \quad \text{and} \quad f = fcn\left( Re_d, \frac{\varepsilon}{d} \right)_{\text{Moodychart}}$$

where  $\varepsilon/d = 0.046/200 = 0.00023$ . If we guess  $f$  as the fully rough value of 0.0141, we find that  $H_p$  is about 60 ft and  $Q$  is about 9000 gal/min (0.57 m<sup>3</sup>/s). To do better would require some very careful plotting and interpolating, or: **EES** is made for this job! Iteration with EES leads to the more accurate solution:

$$f = 0.0144; \quad V = 18.6 \frac{\text{m}}{\text{s}}; \quad P = 162 \text{ hp}; \quad H_p = 58 \text{ ft}$$

$$Q = \mathbf{9260} \frac{\text{gal}}{\text{min}} = 1240 \frac{\text{ft}^3}{\text{min}} \textit{Ans.}$$

The efficiency is **84%**, slightly off the maximum of 88% but not a bad system fit. *Ans.*

**11.67** The pump of Prob. 11.35, running at 880 r/min, is to pump water at 20°C through 75 m of horizontal galvanized-iron pipe ( $\varepsilon = 0.15 \text{ mm}$ ). All other system losses are neglected. Determine the flow rate and input power for (a) pipe diameter = 20 cm; and (b) the pipe diameter yielding maximum pump efficiency.

**Solution:** (a) There is no elevation change, so the pump head matches the friction:

$$H_p = f \frac{L V^2}{d 2g} = f \frac{75 [Q/(\pi(0.2)^2/4)]^2}{0.2 \cdot 2(9.81)} = 19366fQ^2, \quad Re_d = \frac{4\rho Q}{\pi\mu d}, \quad \frac{\varepsilon}{d} = \frac{0.15}{200} = 0.00075$$

But also  $H_p = \text{fcn}(Q)$  from the data in Prob. 11.35. Guessing  $f$  equal to the fully rough value of 0.0183 yields  $Q$  of about 7000 gal/min. Use **EES** to get closer:

$$f = 0.0185; \quad V = 14.4 \frac{\text{m}}{\text{s}}; \quad Re_d = 2.87E6; \quad H_p = 73 \text{ ft};$$

$$Q = 7160 \frac{\text{gal}}{\text{min}} = 0.452 \frac{\text{m}^3}{\text{s}} \quad \text{Ans. (a)}$$

The efficiency is 87%, not bad! (b) If we vary the diameter but hold the pump at maximum efficiency ( $Q^* = 8000$  gal/min), we obtain a best **d = 0.211 ft**. *Ans. (b)*

**11.68** Suppose that we use the axial-flow pump of Fig. 11.13 to drive the leaf blower of Prob. 11.64. What approximate (a) diameter and (b) rotation speed are appropriate? (c) Is this a good design?

**Solution:** Recall that Fig. 11.13 gave BEP coefficients for an axial-flow pump:

$$C_Q^* \approx 0.55; \quad C_H^* \approx 1.07; \quad C_P^* \approx 0.70$$

Apply these coefficients to the leaf-blower data. Neglect minor losses, that is, let the pump head match the pipe friction loss. For air, take  $\rho = 1.2 \text{ kg/m}^3$  and  $\mu = 1.8E-5 \text{ kg/m}\cdot\text{s}$ . Convert  $73 \text{ mi/h} = 32.6 \text{ m/s}$ ,  $4 \text{ ft} = 1.22 \text{ m}$  and  $2.5 \text{ in} = 0.0635 \text{ m}$ :

$$h_f = H_{\text{pump}} = 1.07 \frac{n^2 D^2}{9.81 \text{ m/s}^2} = f \frac{L}{d_{\text{pipe}}} \frac{V_{\text{pipe}}^2}{2g} = f \left( \frac{1.22 \text{ m}}{0.0635 \text{ m}} \right) \left[ \frac{(32.6 \text{ m/s})^2}{2(9.81 \text{ m/s}^2)} \right], \quad f = f(Re_d)$$

$$Q = \frac{\pi}{4} d_{\text{pipe}}^2 V = \frac{\pi}{4} (0.0635 \text{ m})^2 (32.6 \text{ m/s}) = 0.103 \frac{\text{m}^3}{\text{s}} = 0.55 n D^3$$

We know the Reynolds number,  $Re_d = \rho V d / \mu = (1.2)(32.6)(0.0635)/(1.8E-5) = 138,000$ , and for a smooth pipe, from the Moody chart, calculate  $f_{\text{smooth}} = 0.0168$ . Then  $H = h_f = 17.5 \text{ m}$ , and the two equations above can then be solved for:

$$D_{\text{pump}} \approx 0.122 \text{ m} \quad (4.8 \text{ in}); \quad n \approx 104 \text{ r/s} = 6250 \text{ r/min} \quad \text{Ans. (a, b)}$$

This blower is **too fast and too small**, a better (mixed flow) pump can be designed. *Ans. (c)*

**11.69** The pump of Prob. 11.38, running at 3500 rpm, is used to deliver water at 20°C through 600 ft of cast-iron pipe to an elevation 100 ft higher. Find (a) the proper pipe diameter for BEP operation; and (b) the flow rate which results if the pipe diameter is 3 inches.

$Q$ , gal/min:	50	100	150	200	250	300	350	400	450
$H$ , ft:	201	200	198	194	189	181	169	156	139
$\eta$ , %:	29	50	64	72	77	80	81	79	74

**Solution:** For water at 20°C, take  $\rho = 1.94$  slug/ft<sup>3</sup> and  $\mu = 2.09\text{E-}5$  slug/ft·s. For cast iron, take  $\varepsilon \approx 0.00085$  ft. (a) The data above *are* for 3500 rpm, with BEP at 350 gal/min:

$$H^* = 169 \text{ ft} = \Delta z + f \frac{L V^2}{d 2g} = 100 + f \frac{600 [Q/(\pi d^2/4)]^2}{d 2(32.2)} = 100 + \frac{9.18f}{d^5}, \quad Q = Q^* = \frac{350 \text{ ft}^3}{449 \text{ s}}$$

$$\text{Iterate, converges to } Re_d = 2.87\text{E}5, \quad \frac{\varepsilon}{d} = 0.00265, \quad f = 0.0258,$$

$$\mathbf{d \approx 0.321 \text{ ft} = 3.85 \text{ in} \quad \text{Ans. (a)}}$$

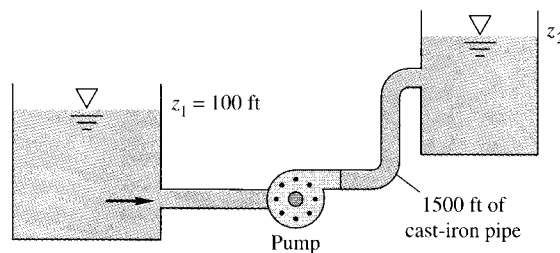
(b) If  $d = 3$  inches, the above solution changes to a new flow rate:

$$\text{Curve-fit: } H \approx 201 - 61Q^{2.7} = 100 + \frac{600 [Q/(\pi(0.25)^2/4)]^2}{0.25 2(32.2)} = 100 + 15466fQ^2$$

$$\text{Iterate or EES: } f = 0.0277, \quad Re = 2.21\text{E}5, \quad H = 193 \text{ ft},$$

$$\mathbf{Q = 0.47 \frac{\text{ft}^3}{\text{s}} = 209 \frac{\text{gal}}{\text{min}} \quad \text{Ans. (b)}}$$

**11.70** The pump of Prob. 11.28, operating at 2134 rpm, is used with water at 20°C in the system of Fig. P11.70. The diameter is 8 inches. (a) If it is operating at BEP, what is the proper elevation  $z_2$ ? (b) If  $z_2 = 225$  ft, what is the flow rate?



**Fig. P11.70**

**Solution:** For water at 20°C, take  $\rho = 1.94 \text{ slug/ft}^3$  and  $\mu = 2.09\text{E-}5 \text{ slug/ft}\cdot\text{s}$ . For cast iron, take  $\varepsilon \approx 0.00085 \text{ ft}$ , hence  $\varepsilon/d \approx 0.00128$ . (a) At BEP from Prob. 11.28,  $Q^* \approx 6 \text{ ft}^3/\text{s}$  and  $H^* \approx 330 \text{ ft}$ . Then the pipe head loss can be determined:

$$V = \frac{Q}{A} = \frac{6}{(\pi/4)(8/12)^2} = 17.2 \frac{\text{ft}}{\text{s}}, \quad \text{Re}_d = \frac{17.2(8/12)}{1.08\text{E-}5} = 1.06\text{E}6, \quad f_{\text{Moody}} \approx 0.0211$$

$$H_{\text{syst}} = \Delta z + f \frac{L}{d} \frac{V^2}{2g} = z_2 - 100 + 0.0211 \left( \frac{1500}{8/12} \right) \frac{(17.2)^2}{2(32.2)} = z_2 - 100 + 218 \stackrel{?}{=} H^* = 330 \text{ ft}$$

Solve for  $z_2 \approx \mathbf{212 \text{ ft}}$  Ans. (a)

(b) If  $z_2 = 225 \text{ ft}$ , the flow rate will be slightly lower and we will be barely off-design:

$$H = H(Q)_{\text{Table}} = \Delta z + f \frac{L}{d} \frac{V^2}{2g} = 225 - 100 + f \frac{1500}{8/12} \frac{V^2}{2(32.2)}, \quad V = \frac{Q}{(\pi/4)(8/12)^2}$$

Converges to  $f \approx 0.0211$ ,  $V \approx 16.6 \frac{\text{ft}}{\text{s}}$ ,  $H \approx 331 \text{ ft}$ ,  $Q \approx \mathbf{5.8 \text{ ft}^3/\text{s}}$  Ans. (b)

**11.71** The pump of Prob. 11.38, running at 3500 r/min, delivers water at 20°C through 7200 ft of horizontal 5-in-diameter commercial-steel pipe. There are a sharp entrance, sharp exit, four 90° elbows, and a gate valve. Estimate (a) the flow rate if the valve is wide open and (b) the valve closing percentage which causes the pump to operate at BEP. (c) If the latter condition holds continuously for 1 year, estimate the energy cost at 10 ¢/kWh.

Data at 3500 rpm:

Q, gal/min:	50	100	150	200	250	300	350	400	450
H, ft:	201	200	198	194	189	181	169	156	139
$\eta$ , %:	29	50	64	72	77	80	81	79	74

**Solution:** For water at 20°C, take  $\rho = 1.94 \text{ slug/ft}^3$  and  $\mu = 2.09\text{E-}5 \text{ slug/ft}\cdot\text{s}$ . For commercial steel, take  $\varepsilon \approx 0.00015 \text{ ft}$ , or  $\varepsilon/d \approx 0.00036$ . The data above show BEP at 350 gal/min. The minor losses are a sharp entrance ( $K = 0.5$ ), sharp exit ( $K = 1.0$ ), 4 elbows ( $4 \times 0.28$ ), and an open gate valve ( $K = 0.1$ ), or  $\sum K \approx \mathbf{2.72}$ . Pump and systems heads are equal:

$$H_p = H(Q)_{\text{Table}} = H_{\text{syst}} = \frac{V^2}{2g} \left( f \frac{L}{d} + \sum K \right), \quad \text{where } V = Q/[(\pi/4)(5/12)^2], \quad \frac{L}{d} \approx 17280$$

The friction factor  $f \geq 0.0155$  depends slightly upon  $Q$  through the Reynolds number.

(a) Iterate on  $Q$  until both heads are equal. The result is

$$f \approx 0.0178, \quad \text{Re}_d \approx 227000, \quad H_p = H_{\text{syst}} \approx 167 \text{ ft}, \quad \mathbf{Q \approx 359 \text{ gal/min}}$$
 Ans. (a)



(b) Bring  $Q$  down to BEP,  $\approx 350$  gpm, by increasing the gate-valve loss. The result is  $f \approx 0.0179$ ,  $Re_d \approx 221000$ ,  $H \approx 169$  ft,  $Q \approx 350$  gpm,  $K_{\text{valve}} \approx \mathbf{21}$  (**25% open**) *Ans. (b)*

(c) Continue case (b) for 1 year. What does it cost at 10¢ per kWh? Well, we know the power level is exactly BEP, so just figure the energy:

$$P = \frac{\rho g Q H}{\eta} = \frac{62.4(350/449)(169)}{0.81} \approx 10152 \frac{\text{ft}\cdot\text{lbf}}{\text{s}} = 13.8 \text{ kW}$$

$$\text{Annual cost} = 13.8(365 \text{ days} \cdot 24 \text{ hours})(\$0.1/\text{kWh}) \approx \mathbf{\$12,100} \quad \text{Ans. (c)}$$

**11.72** Performance data for a small commercial pump are shown below. The pump supplies 20°C water to a horizontal 5/8-in-diameter garden hose ( $\varepsilon \approx 0.01$  in) which is 50 ft long. Estimate (a) the flow rate; and (b) the hose diameter which would cause the pump to operate at BEP.

Q, gal/min:	0	10	20	30	40	50	60	70
H, ft:	75	75	74	72	68	62	47	24

**Solution:** For water at 20°C, take  $\rho = 1.94$  slug/ft<sup>3</sup> and  $\mu = 2.09\text{E}-5$  slug/ft·s. Given  $\varepsilon/d = 0.01/(5/8) \approx 0.016$ , so  $f(\text{fully rough}) \approx 0.045$ . Pump and hose heads must equate, including the velocity head in the outlet jet:

$$H_p = H(Q)_{\text{Table}} = H_{\text{syst}} = \frac{V^2}{2g} \left( f \frac{L}{d} + 1 \right), \quad \frac{L}{d} = \frac{50}{5/8/12} \approx 960, \quad V = \frac{Q}{(\pi/4)(5/8/12)^2}$$

(a) Iterate on  $Q$  until both heads are equal. The result is:

$$f \approx 0.0456, \quad Re_d \approx 50440, \quad V \approx 10.4 \frac{\text{ft}}{\text{s}}, \quad H \approx 75 \text{ ft}, \quad \mathbf{Q \approx 10 \text{ gal/min}} \quad \text{Ans. (a)}$$

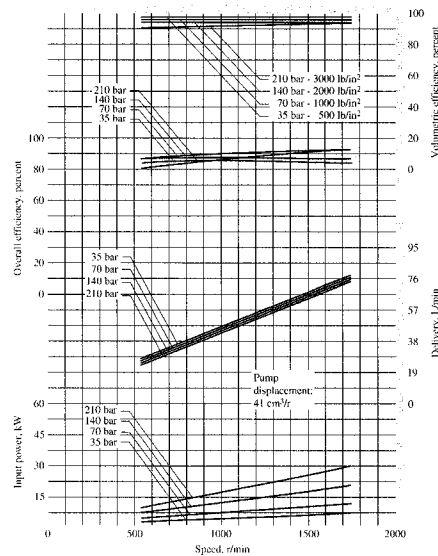
The hose is too small.

(b) We don't know *exactly* where the BEP is, but it typically lies at about 60% of maximum flow rate ( $0.6 \times 77 \approx \mathbf{45}$  gpm). Iterate on hose diameter  $D$  to make the flow rate lie between 40 and 50 gal/min. The results are:

Q = 40 gal/min,	H = 68 ft,	$f \approx 0.0362$ ,	$Re \approx 104000$ ,	$D_{\text{hose}} \approx 1.22$ inches
45	65	0.0354	109000	1.30 inches <i>Ans. (b)</i>
50	62	0.0348	114000	1.38 inches

**11.73** The piston pump of Fig. P11.9 (at right) is run at 1500 rpm to deliver SAE 10W oil through 100 m of vertical 2-cm-diameter wrought-iron pipe. If other system losses are neglected, estimate (a) the flow rate; (b) the pressure rise; and (c) the power required.

**Solution:** For SAE-10W oil, take  $\rho \approx 870 \text{ kg/m}^3$  and  $\mu \approx 0.104 \text{ kg/m}\cdot\text{s}$ . For wrought iron,  $\varepsilon \approx 0.046 \text{ m}$ . From the figure, at 1500 rpm, the delivery is about  $67 \pm 2 \text{ L/min}$  over the whole pressure range. Use this to estimate



**Fig. P11.9**

$$Q \approx 67 \frac{\text{L}}{\text{min}} = 0.00112 \frac{\text{m}^3}{\text{s}}, \quad V = \frac{Q}{A} = \frac{0.00112}{(\pi/4)(0.02)^2} \approx 3.55 \frac{\text{m}}{\text{s}}$$

$$\text{Re}_d = \frac{870(3.55)(0.02)}{0.104} \approx 595 \text{ (laminar)}, \quad H_s = \Delta z + \frac{128\mu LQ}{\pi\rho g d^4} \approx 100 + 348 \approx 448 \text{ m}$$

$$\text{Therefore } \Delta p = \rho g H_s = 870(9.81)(448) \approx \mathbf{38.2 \text{ bar}}$$

All of this checks out pretty well, we accept:  $Q \approx 67 \text{ L/min}$ ,  $\Delta p \approx 38 \text{ bar}$ . *Ans. (a, b)*  
From the figure, the overall efficiency is about 84% at 1500 rpm and 35 bar. Thus

$$\text{Power} = \frac{\rho g Q H}{\eta} = \frac{870(9.81)(0.00112)(448)}{0.84} \approx \mathbf{5100 \text{ W}} \quad \text{Ans. (c)}$$

**11.74** The 32-in-diameter pump in Fig. 11.7a is used at 1170 rpm in a system whose head curve is  $H_s(\text{ft}) \approx 100 + 1.5Q^2$ , with  $Q$  in kgal/min. Find the discharge and brake horsepower required for (a) one pump; (b) two pumps in parallel; and (c) two pumps in series. Which configuration is best?

**Solution:** Assume plain old water,  $\rho g \approx 62.4 \text{ lbf/ft}^3$ . A reasonable curve-fit to the pump head is taken from Fig. 11.7a:  $H_p(\text{ft}) \approx 500 - 0.3Q^2$ , with  $Q$  in kgal/min. Try each case:

(a) **One pump:**  $H_p = 500 - 0.3Q^2 = H_s = 100 + 1.5Q^2$ :  $Q \approx \mathbf{14.9 \text{ kgal/min}}$  *Ans. (a)*

(b) **Two pumps in parallel:**  $500 - 0.3(Q/2)^2 = 100 + 1.5Q^2$ ,  $Q \approx \mathbf{15.9 \text{ kgal/min}}$  *Ans. (b)*

(c) **Two pumps in series:**  $2(500 - 0.3Q^2) = 100 + 1.5Q^2$ :  $Q \approx \mathbf{20.7 \text{ kgal/min}}$  *Ans. (c)*

Clearly **case(c) is best**, because it is very near the BEP of the pump. *Ans.*

**11.75** Two 35-inch pumps from Fig. 11.7*b* are installed in parallel for the system of Fig. P11.75. Neglect minor losses. For water at 20°C, estimate the flow rate and power required if (a) both pumps are running; and (b) one pump is shut off and isolated.

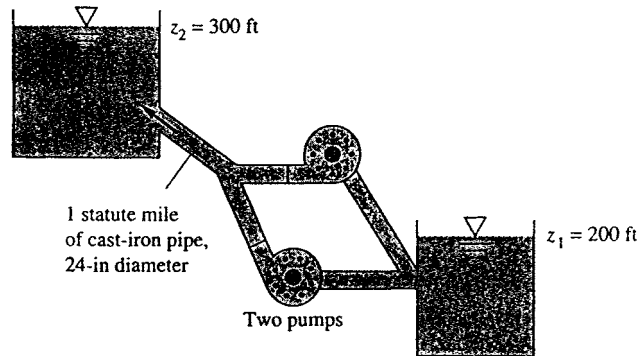


Fig. P11.75

**Solution:** For water at 20°C, take  $\rho = 1.94$  slug/ft<sup>3</sup> and  $\mu = 2.09E-5$  slug/ft·s. For cast iron,  $\varepsilon \approx 0.00085$  ft, or  $\varepsilon/d \approx 0.000425$ . The 35-inch pump has the curve-fit head relation  $H_p(\text{ft}) \approx 235 - 0.006Q^3$ , with  $Q$  in gal/min. In parallel, each pump takes  $Q/2$ :

$$H_p = \text{fcn} \left( \frac{1}{2} Q \right)_{\text{curve-fit}} = H_{\text{syst}} = \Delta z + f \frac{L}{d} \frac{V^2}{2g}, \quad \frac{L}{d} = 2640$$

$$\text{and } V = \frac{Q (\text{ft}^3/\text{s})}{(\pi/4)(2 \text{ ft})^2}, \quad \Delta z = 100 \text{ ft}$$

(a) Two pumps: Iterate on  $Q$  (for  $Q/2$  each) until both heads are equal. The results are:

$$f \approx 0.0164, \quad \text{Re}_d \approx 2.29E6, \quad H_p = H_s = 229 \text{ ft}$$

$$Q_{\text{total}} \approx \mathbf{19600} \frac{\text{gal}}{\text{min}} \quad (9800 \text{ for each pump}) \quad \text{Ans. (a)}$$

$$P = 2P_{\text{each}} = 2 \left[ \frac{62.4(9800/449)(229)}{0.73} \right] = 855000 \div 550 \approx \mathbf{1550 \text{ bhp}} \quad \text{Ans. (a)}$$

(b) One pump: Iterate on  $Q$  alone until both heads are equal. The results are:

$$f \approx 0.0164, \quad \text{Re} \approx 2.3E6, \quad H \approx 203 \text{ ft}, \quad Q \approx \mathbf{17500 \text{ gal/min}} \quad \text{Ans. (b)}$$

$$P = 62.4(17500/449)(203)/0.87 \div 550 \approx \mathbf{1030 \text{ bhp}} \quad \text{Ans. (b)}$$

The pumps in parallel give 12% more flow at the expense of **50%** more power.

**11.76** Two 32-inch pumps are combined in parallel to deliver water at 20°C through 1500 ft of horizontal pipe. If  $f = 0.025$ , what pipe diameter will ensure a flow rate of 35,000 gal/min at 1170 rpm?

**Solution:** For water at 20°C, take  $\rho = 1.94 \text{ slug/ft}^3$  and  $\mu = 2.09\text{E-}5 \text{ slug/ft}\cdot\text{s}$ . As in Prob. 11.74, a reasonable curve-fit to the pump head is taken from Fig. 11.7a:  $H_p(\text{ft}) \approx 500 - 0.3Q^2$ , with  $Q$  in kgal/min. Each pump takes half the flow, 17,500 gal/min, for which

$$H_p \approx 500 - 0.3(17.5)^2 \approx 408 \text{ ft.} \quad \text{Then } Q_{\text{pipe}} = \frac{35000}{449} = 78 \frac{\text{ft}^3}{\text{s}} \text{ and the pipe loss is}$$

$$H_{\text{syst}} = 0.025 \left( \frac{1500}{d} \right) \frac{[78/(\pi d^2/4)]^2}{2(32.2)} = \frac{5740}{d^5} = 408 \text{ ft, solve for } d \approx \mathbf{1.70 \text{ ft}} \quad \text{Ans.}$$

**11.77** Two pumps of the type tested in Prob. 11.22 are to be used at 2140 r/min to pump water at 20°C vertically upward through 100 m of commercial-steel pipe. Should they be in series or in parallel? What is the proper pipe diameter for most efficient operation?

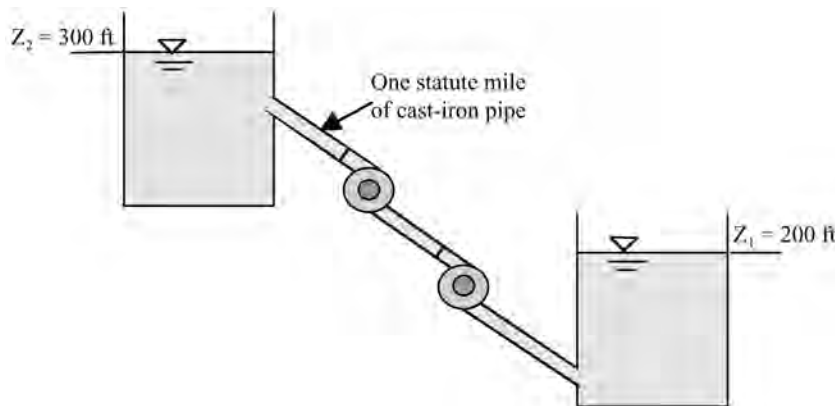
**Solution:** For water take  $\rho = 998 \text{ kg/m}^3$  and  $\mu = 0.001 \text{ kg/m}\cdot\text{s}$ . For commercial steel take  $\varepsilon = 0.046 \text{ mm}$ . **Parallel operation is not feasible**, as the pump can barely generate 100 m of head and the friction loss must be added to this. For **series** operation, assume BEP operation,  $Q^* = 0.2 \text{ m}^3/\text{s}$ ,  $H^* = 95 \text{ m}$ :

$$H_{2\text{pumps}} = 2(95) = \Delta z + f \frac{L V^2}{d 2g} = 100 + f \frac{100 [0.20/(\pi d^2/4)]^2}{2(9.81)} = 100 + \frac{0.3305f}{d^5}$$

Given  $Re_d = 4\rho Q/(\pi\mu d) = 4(998)(0.2)/[\pi(0.001)d] = 254000/d$  and  $\varepsilon/d = 0.000046/d$ , we can iterate on  $f$  until  $d$  is obtained. The **EES** result is:

$$f = 0.0156; Re_d = 1.8\text{E}6; V = 12.7 \text{ m/s, } d_{\text{best}} = \mathbf{0.142 \text{ m}} \quad \text{Ans.}$$

**11.78** Suppose that the two pumps in Fig. P11.75 are instead arranged to be in *series*, again at 710 rpm? What pipe diameter is required for BEP operation?



**Fig. P11.75**

**Solution:** For water at 20°C, take  $\rho = 1.94$  slug/ft<sup>3</sup> and  $\mu = 2.09\text{E-}5$  slug/ft·s. For cast iron,  $\varepsilon \approx 0.00085$  ft. The 35-inch pump has the BEP values  $Q^* \approx 18$  kgal/min,  $H^* \approx 190$  ft. In *series*, each pump takes  $H/2$ , so a BEP series operation would match

$$H_{\text{sys}} = 2H^* = 2(190) = \Delta z + f \frac{L}{d} \frac{V^2}{2g} = 100 + f \left( \frac{5280}{d} \right) \frac{[18000/449/(\pi d^2/4)]^2}{2(32.2)},$$

or:  $380 = 100 + \frac{213800f}{d^5}$ , where  $f$  depends on  $\text{Re} = \frac{4\rho Q}{\pi d \mu}$  and  $\frac{\varepsilon}{d} = \frac{0.00085}{d}$

This converges to  $f \approx 0.0169$ ,  $\text{Re} \approx 2.84\text{E}6$ ,  $V \approx 18.3$  ft/s,  **$d \approx 1.67$  ft.** *Ans.*

$$\text{Power} = 2P^* = 2 \frac{62.4(18000/449)(190)}{0.87} = 1.09\text{E}6 \div 550 \approx \mathbf{2000 \text{ bhp}}$$

We can save money on the smaller (20-inch) pipe, but putting the pumps in *series* requires twice as much power as one pump alone (Prob. 11.75, part b).

**11.79** Two 32-inch pumps from Fig. 11.7a are to be used in *series* at 1170 rpm to lift water through 500 ft of vertical cast-iron pipe. What should the pipe diameter be for most efficient operation? Neglect minor losses.

**Solution:** For water at 20°C, take  $\rho = 1.94$  slug/ft<sup>3</sup> and  $\mu = 2.09\text{E-}5$  slug/ft·s. For cast iron,  $\varepsilon \approx 0.00085$  ft. From Fig. 11.7a, read  $H^* \approx 385$  ft at  $Q^* \approx 20,000$  gal/min. Equate

$$H_p = 2H^* = 2(385) = H_{\text{sys}} = \Delta z + f \frac{L}{d} \frac{V^2}{2g}$$

$$= 500 + f \left( \frac{500}{d} \right) \frac{\left[ \frac{20000}{449} (\pi d^2/4) \right]^2}{2(32.2)} = 500 + \frac{24992f}{d^5}$$

Iterate, guessing  $f \approx 0.02$  to get  $d$ , then get  $\text{Re}_d$  and  $\varepsilon/d$  and repeat. The final result is

$$f \approx 0.0185, \quad V \approx 45.8 \text{ ft/s}, \quad \text{Re}_d \approx 4.72\text{E}6, \quad \mathbf{d \approx 1.11 \text{ ft}} \quad \textit{Ans.}$$

**11.80** It is proposed to use one 32- and one 28-in pump from Fig. 11.7a in parallel to deliver water at 60°F. The system-head curve is  $H_s = 50 + 0.3Q^2$ , with  $Q$  in thousands of gallons per minute. What will the head and delivery be if both pumps run at 1170 r/min? If the 28-in pump is reduced below 1170 r/min, at what speed will it cease to deliver?

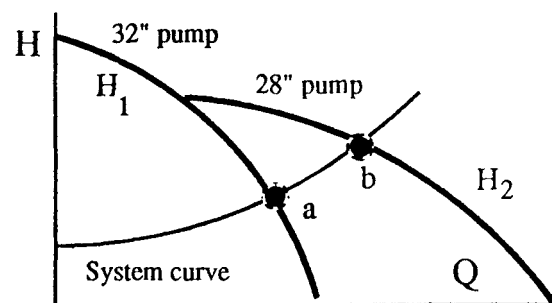


Fig. P11.80

**Solution:** For water at 60°F, take  $\rho = 1.94 \text{ slug/ft}^3$ . Use the following two curve-fits:

$$D = 32\text{''}: H_1 \approx 500 - 0.3Q_1^2; \quad D = 28\text{''}: H_2 \approx 360 - 0.24Q_2^2, \quad (Q \text{ in kgal/min})$$

For pumps in parallel, the flow rates *add* and the pumps heads are *equal*:

$$\text{Continuity: } Q_1 + Q_2 = Q_{\text{sys}}; \quad \text{Heads: } H_1 = H_2 = H_{\text{sys}}$$

$$\therefore 500 - 0.3Q_1^2 = 360 - 0.24Q_2^2 = 50 + 0.3(Q_1 + Q_2)^2$$

$$\text{Solve for: } Q_1 \approx \mathbf{22900 \text{ gpm}}; \quad Q_2 \approx \mathbf{8400 \text{ gpm}}; \quad H \approx \mathbf{343 \text{ ft}} \quad \text{Ans.}$$

If pump “2” reduces speed, it ceases to deliver ( $Q_2 = 0$ ) when its shut-off head equals **point ‘a’** in the figure on previous page, where the system curve crosses pump-head “1.” Thus:

$$500 - 0.3Q_1^2 \stackrel{?}{=} 50 + 0.3Q_1^2 \quad \text{or: } Q_1 \approx \mathbf{27400 \text{ gal/min}} \quad \text{and} \quad H_2 = H_1 \approx \mathbf{275 \text{ ft.}}$$

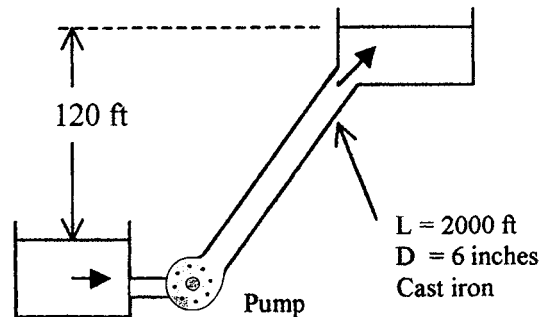
$$\text{Pump-2 speed is } n_{2\text{-new}} = n_{2\text{-old}} \left( \frac{H_{2\text{-new}}}{H_{2\text{-old}}} \right)^{1/2} = 1170 \left( \frac{275}{360} \right)^{1/2} \approx \mathbf{1020 \text{ rpm}} \quad \text{Ans.}$$

**11.81** Reconsider the system of Fig. P6.62. Use the Byron Jackson pump of Prob. 11.28 running at 2134 r/min, no scaling, to drive the flow. Determine the resulting flow rate between the reservoirs. What is the pump efficiency?

**Solution:** For water take  $\rho = 1.94 \text{ slug/ft}^3$  and  $\mu = 2.09\text{E-}5 \text{ slug/ft}\cdot\text{s}$ . For cast iron take  $\varepsilon = 0.00085 \text{ ft}$ , or  $\varepsilon/d = 0.00085/0.5 = 0.0017$ . The energy equation, written between reservoirs, is the same as in Prob. 6.62:

$$H_p = \Delta z + f \frac{L}{d} \frac{V^2}{2g} = 120 \text{ ft} + f \frac{2000}{0.5} \frac{[Q/(\pi(0.5)^2/4)]^2}{2(32.2)} = 120 + 1611fQ^2$$

$$\text{where } f = f_{\text{Moody}} = fcn \left( Re_d, \frac{\varepsilon}{d} \right) \quad \text{with } Re_d = \frac{4\rho Q}{\pi\mu d}$$



From the data in Prob. 11.28 for the pump,  $H_p = \text{fcn}(Q)$  and is of the order of 300 ft. Guessing  $f \approx 0.02$ , we can estimate a flow rate of about  $Q \approx 2.4 \text{ ft}^3/\text{s}$ , down in the low range of the Byron-Jackson pump. Get a closer result with EES:

$$H_p = 340 \text{ ft}; f = 0.0228; Re_d = 579,000;$$

$$V = 12.5 \frac{\text{ft}}{\text{s}}; \text{bhp} = 169 \text{ hp}; Q = 2.45 \frac{\text{ft}^3}{\text{s}} \quad \text{Ans.}$$

Interpolating, the pump efficiency is  $\eta \approx 56\%$ . Ans. The flow rate is too low for this particular pump.

**11.82** The S-shaped head-versus-flow curve in Fig. P11.82 occurs in some axial-flow pumps. Explain how a fairly *flat* system-loss curve might cause instabilities in the operation of the pump. How might we avoid instability?

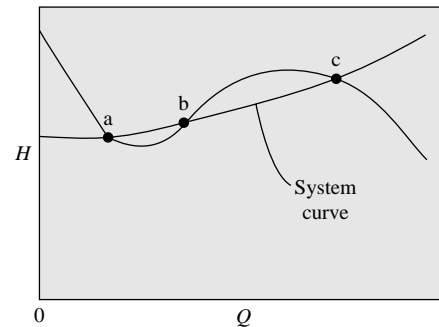


Fig. P11.82

**Solution:** The stability of pump operation is nicely covered in the review article by Greitzer (Ref. 41 of Chap. 11). Generally speaking, there is little danger of instability if the slope of the pump-head curve,  $dH/dQ$ , is *negative*, unless there are two such points. In Fig. P11.82 above, a flat system curve may cross the pump curve at *three* points (a, b, c). Of these 3, **point b is statically unstable** and cannot be maintained. Consider a small disturbance near point b: Suppose the flow rate drops slightly—then the system head decreases, but the pump head decreases *even more*. Then the flow rate will drop still *more*, etc., and we move away from the operating point, which therefore is *unstable*. The general rule is:

A pump operating point is statically unstable if the (positive) slope of the pump-head curve is greater than the (positive) slope of the system curve.

By this criterion, both points *a* and *c* above are statically stable. However, if the points are close together or there are large disturbances, a pump can “hunt” or oscillate between points *a* and *c*, so this could also be considered **unstable to large disturbances**.

Finally, even a steep system curve (not shown above) which crosses at only a single point *b* on the positive-slope part of the pump-head curve can be dynamically unstable, that is, it can trigger an energy-feeding oscillation which diverges from point *b*. See Greitzer’s article for further details of this and other turbomachine instabilities.

**11.83** The low-shutoff head-versus-flow curve in Fig. P11.83 occurs in some centrifugal pumps. Explain how a fairly flat system-loss curve might cause instabilities in the operation of the pump. What additional vexation occurs when two of these pumps are in parallel? How might we avoid instability?

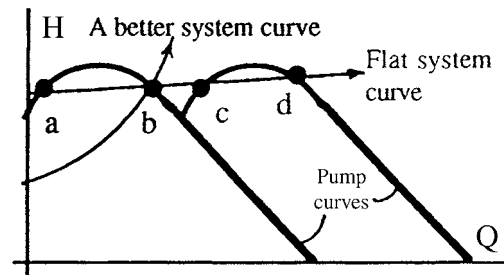


Fig. P11.83

**Solution:** As discussed, for one pump with a flat system curve, point *a* is statically unstable, point *b* is stable. A ‘better’ system curve only passes through *b*.

For two pumps in parallel, both points *a* and *c* are unstable (see above). Points *b* and *d* are stable but for large disturbances the system can ‘hunt’ between the two points.

**11.84** Turbines are to be installed where the net head is 400 ft and the flow rate is 250,000 gal/min. Discuss the type, number, and size of turbine which might be selected if the generator selected is (a) 48-pole, 60-cycle ( $n = 150$  rpm); or (b) 8-pole ( $n = 900$  rpm). Why are at least two turbines desirable from a planning point of view?

**Solution:** We select **two** turbines, of about half-flow each, so that one is still available for power generation if the other is shut down for maintenance or repairs. *Ans.*

Assume  $\eta \approx 90\%$ :

$$P_{\text{total}} = \eta \rho g Q H \approx 0.9(62.4) \left( \frac{250000}{449} \right) (400) \div 550 \approx 22750 \text{ hp (each turbine } \approx 11375 \text{ hp)}$$

(a)  $n = 150$  rpm:

$$N_{\text{sp}} = \frac{n P^{1/2}}{H^{5/4}} = \frac{150(11375)^{1/2}}{(400)^{5/4}} \approx \mathbf{8.9} \text{ (select two } \mathbf{\textit{impulse turbines}} \text{) } \textit{Ans. (a)}$$

$$\text{Estimate } \phi \approx 0.47 = \frac{\pi n D}{\sqrt{2gH}} = \frac{\pi(150/60)D}{\sqrt{2(32.2)(400)}}, \text{ or: } \mathbf{D \approx 9.6 \text{ ft}} \textit{ Ans. (a)}$$

(b)  $n = 900$  rpm:  $N_{\text{sp}} = \frac{900(11375)^{1/2}}{(400)^{5/4}} \approx \mathbf{54}$  (select **two Francis turbines**) *Ans. (b)*

$$\text{Fig. 11.21: } C_p^* \approx 2.6 = \frac{P^*}{\rho n^3 D^5} = \frac{11375 \times 550}{1.94 \left( \frac{900}{60} \right)^3 D^5}, \text{ solve } \mathbf{D \approx 3.26 \text{ ft}} \textit{ Ans. (b)}$$

**11.85** Turbines at the Conowingo plant on the Susquehanna River each develop 54,000 bhp at 82 rpm under a head of 89 ft. What type of turbines are these? Estimate the flow rate and impeller diameter.



**Solution:** The turbine specific speed tells us the type and the power tells us the flow rate:

$$N_{sp} = \frac{nP^{1/2}}{H^{5/4}} = \frac{82(54000)^{1/2}}{(89)^{5/4}} \approx \mathbf{70} \quad (\text{These are } \mathbf{Francis} \text{ turbines}) \quad \text{Ans.}$$

$$\text{Fig. 11.27: } \eta \approx 93\%, \quad P = 54000 \times 550 = 0.93(62.4)(89)Q,$$

$$\text{or: } \mathbf{Q} \approx \mathbf{5800} \frac{\text{ft}^3}{\text{s}} \quad \text{Ans.}$$

$$\text{Fig. 11.21: } C_P^* \approx 2.6 = \frac{P^*}{\rho n^3 D^5} = \frac{54000(550)}{1.94 \left(\frac{82}{60}\right)^3 D^5}, \quad \text{or: } \mathbf{D} \approx \mathbf{19} \text{ ft} \quad \text{Ans.}$$

**11.86** The Tupperware hydroelectric plant on the Blackstone River has four 36-inch-diameter turbines, each providing 447 kW at 200 rpm and 205 ft<sup>3</sup>/s for a head of 30 ft. What type of turbines are these? How does their performance compare with Fig. 11.21?

**Solution:** Convert  $P^* = 447 \text{ kW} = 599 \text{ hp}$ . Then, for  $D = 36'' = 3.0 \text{ ft}$ ,

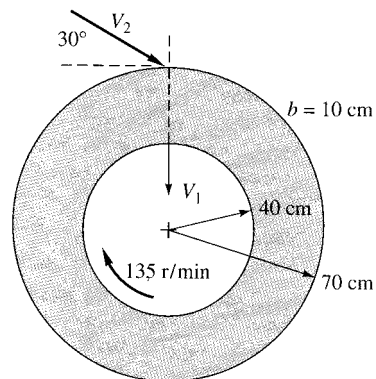
$$N_{sp} = \frac{nP^{1/2}}{H^{5/4}} = \frac{200(599)^{1/2}}{(30)^{5/4}} \approx \mathbf{70} \quad (\text{These are } \mathbf{Francis} \text{ turbines}) \quad \text{Ans.}$$

Use the given data to compute the dimensionless BEP coefficients:

$$C_Q^* = \frac{205}{(200/60)(3.0)^3} \approx \mathbf{2.3}; \quad C_P^* = \frac{599(550)}{1.94(200/60)^3(3)^5} \approx \mathbf{19} \quad (\text{both are } \mathbf{quite} \text{ different!})$$

$$C_H^* = \frac{32.2(30)}{(200/60)^2(3)^2} \approx \mathbf{9.7} \quad (\mathbf{OK}); \quad \eta_{\max} = \frac{599(550)}{62.4(205)(30)} \approx \mathbf{86\%} \quad (\mathbf{OK}) \quad \text{Ans.}$$

**11.87** An idealized radial turbine is shown in Fig. P11.87. The absolute flow enters at 30° and leaves radially inward. The flow rate is 3.5 m<sup>3</sup>/s of water at 20°C. The blade thickness is constant at 10 cm. Compute the theoretical power developed at 100% efficiency.



**Fig. P11.87**

**Solution:** For water, take  $\rho \approx 998 \text{ kg/m}^3$ . With reference to Fig. 11.22 and Eq. 11.35,

$$u_2 = \omega r_2 = 135 \left( \frac{2\pi}{60} \right) (0.7) = 9.90 \frac{\text{m}}{\text{s}}, \quad \alpha_2 = 30^\circ, \quad \alpha_1 = 90^\circ, \quad V_{n2} = \frac{3.5}{2\pi(0.7)(0.1)} \approx 7.96 \frac{\text{m}}{\text{s}}$$

$$V_{t2} = \frac{V_{n2}}{\tan \alpha_2} = \frac{7.96}{\tan 30^\circ} = 13.8 \frac{\text{m}}{\text{s}} \quad \text{and} \quad V_{t1} = \frac{V_{n1}}{\tan 90^\circ} = 0$$

Thus  $P_{\text{theory}} = \rho Q u_2 V_{t2} = 998(3.5)(9.90)(13.8) = 477000 \text{ W} \approx \mathbf{477 \text{ kW}}$  *Ans.*

**11.88** Performance data for a very small ( $D = 8.25 \text{ cm}$ ) model water turbine, operating with an available head of 49 ft, are as follows:

$Q, \text{ m}^3/\text{h}$ :	18.7	18.7	18.5	18.3	17.6	<b>16.7</b>	15.1	11.5
rpm:	0	500	1000	1500	2000	<b>2500</b>	3000	3500
$\eta$ :	0	14%	27%	38%	50%	<b>65%</b>	61%	11%

(a) What type of turbine is this likely to be? (b) What is so different about this data compared to the dimensionless performance plot in Fig. 11.21*d*? Suppose it is desired to use a geometrically similar turbine to serve where the available head and flow are 150 ft and  $6.7 \text{ ft}^3/\text{s}$ , respectively. Estimate the most efficient (c) turbine diameter; (d) rotation speed; and (e) horsepower.

**Solution:** (a) Convert  $Q = 16.7 \text{ m}^3/\text{h} = 0.164 \text{ ft}^3/\text{s}$ . Use BEP data to calculate power specific speed:

$$bhp = \rho g Q H \eta = (62.4 \text{ lbf/ft}^3)(0.164 \text{ ft}^3/\text{s})(49 \text{ ft})(0.65) = 326 \text{ ft}\cdot\text{lbf/s} = 0.593 \text{ hp}$$

$$N_{sp} = \frac{\text{rpm}(bhp)^{1/2}}{(H\text{-ft})^{5/4}} = \frac{(2500 \text{ rpm})(0.593 \text{ bhp})^{1/2}}{(49 \text{ ft})^{5/4}} \approx 15 \text{ (Francis turbine)} \quad \text{Ans. (a)}$$

(b) This data is different because it has *variable speed*. Our other data is at constant speed. *Ans. (b)*

(c, d, e) First establish the BEP coefficients from the small-turbine data:

$$C_Q^* = \frac{Q}{nD^3} = \frac{(16.7/3600 \text{ m}^3/\text{h})}{(2500/60 \text{ r/s})(0.0825 \text{ m})^3} = \mathbf{0.198};$$

$$C_H^* = \frac{gH}{n^2 D^2} = \frac{(9.81)(49 * 0.3048 \text{ m})}{(2500/60)^2 (0.0825)^2} = \mathbf{12.4}$$

$$C_P^* = \frac{P}{\rho n^3 D^5} = \frac{(326 * 1.3558 \text{ W})}{(998 \text{ kg/m}^3)(2500/60 \text{ r/s})^3 (0.0825 \text{ m})^5} = \mathbf{1.60}$$

Now enter the new data, in *English* units, to the flow and head coefficients:

$$C_Q^* = \frac{6.7 \text{ ft}^3/\text{s}}{n_2 D_2^3} = 0.198; \quad C_H^* = \frac{(32.2 \text{ ft/s}^2)(150 \text{ ft})}{n_2^2 D_2^2} = 12.4$$

Solve for  $n_2 = 15.1 \text{ r/s} = \mathbf{904 \text{ r/min}}$ ;  $D_2 = 1.31 \text{ ft} = \mathbf{15.7 \text{ in}}$  *Ans.* (c, d)

$$\text{Then } P_2 = C_P^* \rho n_2^3 D_2^5 = 1.60(1.94 \text{ slug/ft}^3)(15.1 \text{ r/s})^3(1.31 \text{ ft})^5$$

$$P_2 = 41,000 \frac{\text{ft}\cdot\text{lbf}}{\text{s}} = \mathbf{74 \text{ hp}}$$
 *Ans.* (e)

Actually, since the new turbine is 4.84 times larger, we could use the Moody step-up formula, Eq. (11.29a), to predict  $(1 - \eta_2) \approx (1 - 0.65)/(4.84)^{1/4} = 0.236$ , or  $\eta_2 = 0.764 = 76.4\%$ . We thus expect more power from the larger turbine:

$$P_2 = (74 \text{ hp})(76\%/65\%) \approx \mathbf{87 \text{ hp Better}}$$
 *Ans.* (e)

**11.89** A Pelton wheel of 12-ft pitch diameter operates under a new head of 2000 ft. Estimate the speed, power output, and flow rate for best efficiency if the nozzle exit diameter is 4 inches.

**Solution:** First get the jet velocity and then assume BEP at  $\phi \approx 0.47$ :

$$C_v \approx 0.94, \quad \text{so: } V_{\text{jet}} = C_v \sqrt{2gH} = 0.94 \sqrt{2(32.2)(2000)} \approx 337 \text{ ft/s}$$

$$\text{BEP at } \phi \approx 0.47 = \frac{\pi n D}{\sqrt{2gH}} = \frac{\pi n(12.0)}{\sqrt{2(32.2)(2000)}},$$

$$\text{Solve } n = 4.47 \frac{\text{r}}{\text{s}} \times 60 \approx \mathbf{268 \text{ rpm}}$$
 *Ans.*

$$Q = V_{\text{jet}} A_{\text{nozzle}} = 337 \left( \frac{\pi}{4} \right) \left( \frac{4}{12} \right)^2 = 29.4 \frac{\text{ft}^3}{\text{s}} \approx \mathbf{13200 \frac{\text{gal}}{\text{min}}}$$
 *Ans.*

$$u_{\text{best}} = V_{\text{jet}}/2 \approx 169 \text{ ft/s}$$

$$P_{\text{theory}} = \rho Q u (V_j - u)(1 - \cos \beta)$$

$$\approx 1.94(29.4)(169)(337 - 169)(1 - \cos 165^\circ) \div 550 \approx 5800 \text{ hp}_{100\%}$$

$$P_{\text{turb}} \approx 4500 \text{ bhp}, \quad N_{\text{sp}} \approx \frac{268(4500)^{1/2}}{(2000)^{5/4}} \approx 1.34: \quad \text{Fig. 11.27, read } \eta_{\text{max}} < 80\%, \text{ say, } 75\%$$

$$\text{Actual power output} \approx \eta P_{100\%} = 0.75(5800) \approx \mathbf{4350 \text{ bhp}}$$
 *Ans.*

**11.90** An idealized radial turbine is shown in Fig. P11.90. The absolute flow enters at  $25^\circ$  with the blade angles as shown. The flow rate is  $8 \text{ m}^3/\text{s}$  of water at  $20^\circ\text{C}$ . The blade thickness is constant at 20 cm. Compute the theoretical power developed at 100% efficiency.

**Solution:** The inlet (2) and outlet (1) velocity vector diagrams are shown at right. The normal velocities are

$$V_{n2} = Q/A_2 = \frac{8.0}{2\pi(1.2)(0.2)} = 5.31 \text{ m/s}$$

$$V_{n1} = Q/A_1 = \frac{8.0}{2\pi(0.8)(0.2)} = 7.96 \text{ m/s}$$

From these we can compute the tangential velocities at each section:

$$u_2 = \omega r_2 = 80 \left( \frac{2\pi}{60} \right) (1.2) = 10.1 \text{ m/s};$$

$$u_1 = \omega r_1 = 80 \left( \frac{2\pi}{60} \right) (0.8) = 6.70 \text{ m/s}$$

$$V_{t2} = V_{n2} \cot 25^\circ = 11.4 \text{ m/s}; \quad V_{t1} = u_1 - V_{n1} \tan 30^\circ = 2.11 \text{ m/s}$$

$$P_{\text{theory}} = \rho Q(u_2 V_{t2} - u_1 V_{t1}) = 998(8)[10.1(11.4) - 6.7(2.11)] \approx \mathbf{800,000 \text{ W}} \quad \text{Ans.}$$

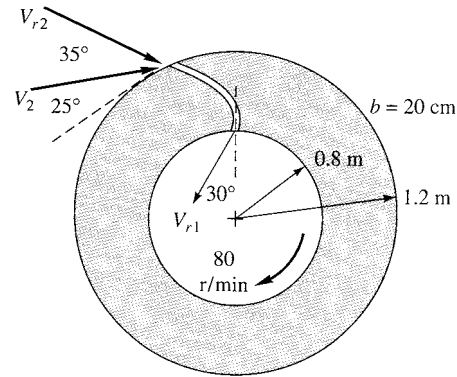
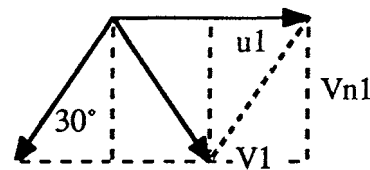
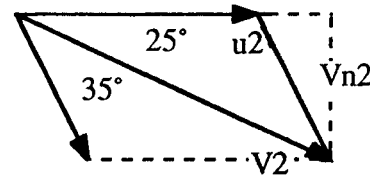


Fig. P11.90



**11.91** The flow through an axial-flow turbine can be idealized by modifying the stator-rotor diagrams of Fig. 11.12 for energy absorption. Sketch a suitable blade and flow arrangement and the associated velocity vector diagrams. For further details, see Chap. 8 of Ref. 25.

**Solution:** Some typical velocity diagrams are shown on the next page, where  $u = \omega r =$  blade speed. The power delivered to the turbine, at 100% ideal shock-free flow, is

$$P_{\text{ideal}} = \rho Q(u_1 V_{t1} - u_2 V_{t2})$$

where  $V_{t1,2}$  are the tangential components of  $V_{1,2}$

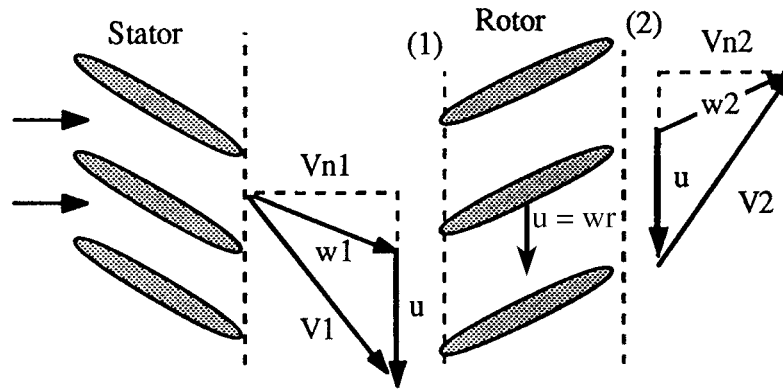


Fig. P11.91

**11.92** A dam on a river is being sited for a hydraulic turbine. The flow rate is  $1500 \text{ m}^3/\text{h}$ , the available head is 24 m, and the turbine speed is to be 480 r/min. Discuss the estimated turbine size and feasibility for (a) a Francis turbine; and (b) a Pelton wheel.

**Solution:** Assume  $\eta \approx 89\%$ , as in Fig. 11.21d. The power generated by the turbine would be  $P = \eta \gamma Q H = (0.89)(62.4 \text{ lbf/ft}^3)(14.7 \text{ ft}^3/\text{s})(78.7 \text{ ft}) = 64,300 \text{ ft-lbf/s} = 117 \text{ hp}$ . Now compute  $N_{sp} = (480 \text{ rpm})(117 \text{ hp})^{1/2}/(78.7 \text{ ft})^{5/4} \approx 22$ , appropriate for a Francis turbine. (a) A Francis turbine, similar to Fig. 11.21d, would have  $C_Q^* \approx 0.34 = (14.7 \text{ ft}^3/\text{s})/[(480/60 \text{ r/s})D^3]$ . Solve for a turbine diameter of about **1.8 ft**, which would be excellent for the task. *Ans.* (a)

(b) A Pelton wheel at best efficiency (half the jet velocity) would only be **18 inches** in diameter, with a huge nozzle,  $d \approx 6$  inches, which is too large for the wheel. We conclude that a Pelton wheel would be a poor design. *Ans.* (b)

**11.93** Figure P11.93 shown on the following page, shows a *crossflow* or “Banki” turbine [Ref. 55], which resembles a squirrel cage with slotted curved blades. The flow enters at about 2 o’clock, passes through the center and then again through the blades, leaving at about 8 o’clock.

Report to the class on the operation and advantages of this design, including idealized velocity vector diagrams.

**Brief Discussion** (not a “Solution”):

The crossflow turbine is ideal for small dam owners, because of its simple, inexpensive design. It can easily be constructed by a novice (such as the writer) from wood and plastic.

It is not especially efficient ( $\approx 60\%$ ) but makes good, inexpensive use of a small stream to produce electric power. For details, see Ref. 55 or the paper “Design and Testing of an Inexpensive Crossflow Turbine,” by W. Johnson et al., ASME Symposium on Small Hydropower Fluid Machinery, Phoenix, AZ, Nov. 1982, ASME vol. H00233, pp. 129–133.

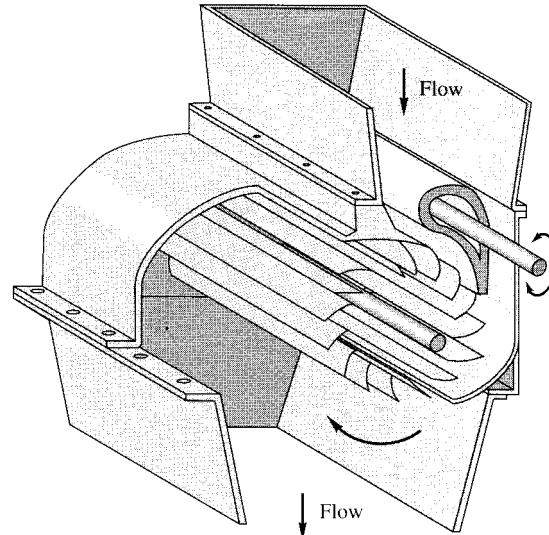


Fig. P11.93

**11.94** A simple crossflow turbine, Fig. P11.93 above, was constructed and tested at the University of Rhode Island. The blades were made of PVC pipe cut lengthwise into three  $120^\circ$ -arc pieces. When tested in water at a heads of 5.3 ft and a flow rate of 630 gal/min, the measured power output was 0.6 hp. Estimate (a) the efficiency; and (b) the power specific speed if  $n \approx 200$  rpm.

**Solution:** We have sufficient information to compute the available water power:

$$P_{\text{avail}} = \rho g Q H = (62.4) \left( \frac{630}{449} \right) (5.3) = 464 \div 550 = 0.844 \text{ hp}, \quad \therefore \eta = \frac{0.6}{0.844} \approx 71\% \quad \text{Ans. (a)}$$

$$\text{At } 200 \text{ rpm, } N_{\text{sp}} = \frac{\text{rpm}(\text{hp})^{1/2}}{(\text{head})^{5/4}} = \frac{200(0.6)^{1/2}}{(5.3)^{5/4}} \approx 19 \quad \text{Ans. (b)}$$

**11.95** One can make a theoretical estimate of the proper diameter for a penstock in an impulse turbine installation, as in Fig. P11.95. Let  $L$  and  $H$  be known, and let the turbine performance be idealized by Eqs. (11.38) and (11.39). Account for friction loss  $h_f$  in the penstock, but neglect minor losses. Show that (a) the maximum power is generated when  $h_f = H/3$ , (b) the optimum jet velocity is  $(4gH/3)^{1/2}$ , and (c) the best nozzle diameter is  $D_j = [D^5/(2fL)]^{1/4}$ , where  $f$  is the pipe-friction factor.

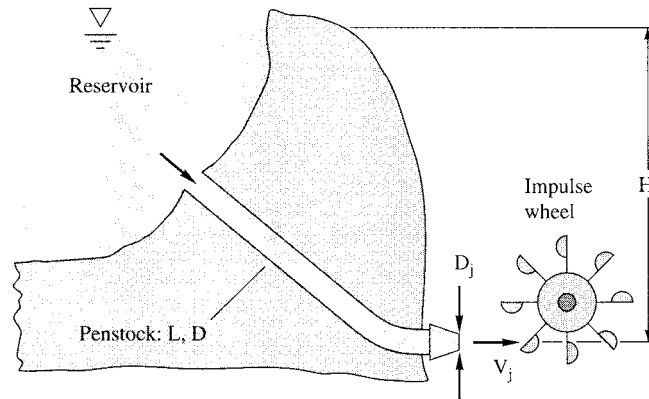


Fig. P11.95

**Solution:** From Eqs. 11.38 and 39, maximum power is obtained when  $u = V_j/2$ , or:

$$P_{\max} = \rho Q \frac{V_j}{2} \left( V_j - \frac{V_j}{2} \right) (1 - \cos \beta) = \rho A_j \left( \frac{1 - \cos \beta}{4} \right) V_j^3 = C V_j^2 V_j, \quad C = \text{constant}$$

Now apply the steady-flow energy equation between the reservoir and the outlet jet:

$$\Delta z = H = f \frac{L}{D} \frac{V_{\text{pipe}}^2}{2g} + \frac{V_j^2}{2g}, \quad \text{or:} \quad V_j^2 = 2gH - f \frac{L}{D} \left( \frac{D_j}{D} \right)^4 V_j^2 \quad \text{since} \quad V_j \frac{\pi}{4} D_j^2 = V_p \frac{\pi}{4} D^2$$

$$\text{Thus} \quad P_{\max} = C \left[ 2gH V_j - f \frac{L}{D} \left( \frac{D_j}{D} \right)^4 V_j^3 \right]; \quad \text{Differentiate:} \quad \frac{dP_{\max}}{dV_j} = 0 \quad \text{if} \quad 2gH = 3f \frac{L}{D} V_p^2$$

or if:  $H = 3h_{f,\text{pipe}}!$  The pipe head loss =  $\mathbf{H/3}$  Ans. (a)

$$\text{Continuing, } V_j^2|_{\text{optimum}} = 2g(H - h_f) = 2g(H - H/3), \quad \text{or:} \quad V_{j,\text{optimum}} = \sqrt{\frac{4}{3} gH} \quad \text{Ans. (b)}$$

Then the correct pipe flow speed is obtained by back-substitution:

$$f \frac{L}{D} \frac{V_{\text{pipe}}^2}{2g} = \frac{H}{3}, \quad \text{or:} \quad V_{\text{pipe}} = \sqrt{\frac{2gH}{3fL/D}}$$

$$\text{Continuing, } V_p^2 = V_j^2 \left( \frac{D_j}{D} \right)^4 = \frac{2gH}{3fL/D}, \quad \text{solve for } D_{\text{jet}} = \left( \frac{D_p^5}{2fL} \right)^{1/4} \quad \text{Ans. (c)}$$

**11.96** Apply the results of Prob. 11.95 to determining the optimum (a) penstock diameter, and (b) nozzle diameter for the data of Prob. 11.92, with a commercial-steel penstock of length 1500 ft. [ $H = 800$  ft,  $Q = 40,000$  gal/min.]

**Solution:** For water, take  $\rho = 1.94$  slug/ft<sup>3</sup> and  $\mu = 2.09\text{E-}5$  slug/ft·s. For commercial steel,  $\varepsilon \approx 0.00015$  ft. We can't find  $f_{\text{Moody}}$  until we know  $D$ , so iteration is required. We can immediately compute  $V_{\text{jet}} = (4gH/3)^{1/2} \approx 185$  ft/s, but this wasn't asked! Anyway,

$$h_f = H/3 = 267 \text{ ft} = f \frac{L}{D} \frac{V_p^2}{2g} = f \frac{1500}{D} \frac{V_p^2}{2(32.2)}, \quad \text{where } V_{\text{pipe}} = \frac{40000/449}{(\pi/4)D^2} \text{ (ft/s)}$$

Iterate to find  $f \approx 0.0120$ ,  $Re_D \approx 6.24\text{E}6$ , and  $D = D_{\text{penstock}} \approx \mathbf{1.68 \text{ ft}}$  *Ans. (a)*

$$\text{Then } D_{\text{jet}} = \left( \frac{D^5}{2fL} \right)^{1/4} = \left[ \frac{(1.68)^5}{2(0.0120)(1500)} \right]^{1/4} \approx \mathbf{0.78 \text{ ft} = 9.4 \text{ inches}}$$
 *Ans. (b)*

**11.97** Consider the following non-optimum version of Prob. 11.95:  $H = 450$  m,  $L = 5$  km,  $D = 1.2$  m,  $D_j = 20$  cm. The penstock is concrete,  $\varepsilon = 1$  mm. The impulse wheel diameter is 3.2 m. Estimate (a) the power generated by the wheel at 80% efficiency; and (b) the best speed of the wheel in r/min. Neglect minor losses.

**Solution:** For water take  $\rho = 998$  kg/m<sup>3</sup> and  $\mu = 0.001$  kg/m·s. This is a non-optimum condition, so we simply make a standard energy and continuity analysis. Refer to the figure on the next page for the notation:

$$\Delta z = H = h_f + \frac{V_j^2}{2g}, \quad V_j D_j^2 = V_{\text{pipe}} D^2, \quad \text{combine and solve for jet velocity:}$$

$$V_j^2 \left[ 1 + f \frac{L}{D} \left( \frac{D_j}{D} \right)^4 \right] = 2gH, \quad \text{where } f = fcn \left( \frac{\rho V D}{\mu}, \frac{\varepsilon}{D} \right), \quad \frac{\varepsilon}{D} = \frac{0.001}{1.2} = 8.33\text{E-}4$$

For example, guessing  $f \approx 0.02$ , we estimate  $V_j \approx 91.2$  m/s. Using **EES** yields

$$f = 0.0189, \quad Re_d = 3.03\text{E}6, \quad V_{\text{jet}} = 91.23 \frac{\text{m}}{\text{s}}, \quad Q = \mathbf{2.87 \frac{\text{m}^3}{\text{s}}}$$

The power generated (at 80% efficiency) and best wheel speed are

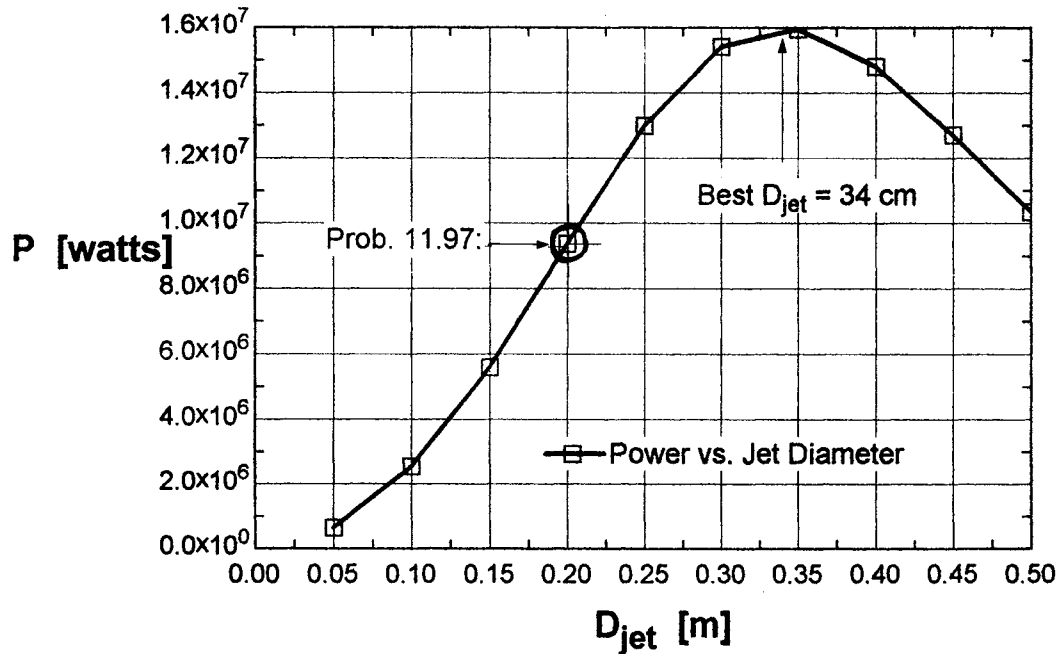
$$\text{Power} = \rho Q u_{\text{wheel}} (V_j - u_{\text{wheel}}) (1 - \cos \beta) (0.8), \quad u_{\text{best}} = \frac{1}{2} V_{\text{jet}} = \Omega_{\text{wheel}} \frac{D_{\text{wheel}}}{2}, \quad \beta \approx 165^\circ$$

$$\text{If } D_{\text{wheel}} = 3.2 \text{ m, solve for } \Omega_{\text{wheel}} = 28.5 \frac{\text{rad}}{\text{s}} = \mathbf{272 \frac{\text{rev}}{\text{min}}}$$

$$\text{Power} = \mathbf{9.36 \text{ MW}}$$
 *Ans. (a, b)*



As shown on the figure below, which varies  $D_j$ , the optimum jet diameter is 34 cm, not 20 cm, and the optimum power would be 16 MW, or 70% more!



**11.98** Francis and Kaplan (enclosed) turbines are often provided with *draft tubes*, which lead the exit flow into the tailwater region, as in Fig. P11.98. Explain at least two advantages to using a draft tube.

**Solution:** Draft tubes have two big advantages:

(1) They reduce the *exit loss*, since a draft tube is essentially a diffuser, as in Fig. 6.23 of the text, so more of the water head is converted to power.

(2) They reduce total losses *downstream of the turbine*, so that the turbine runner can be placed higher up without the danger of cavitation.

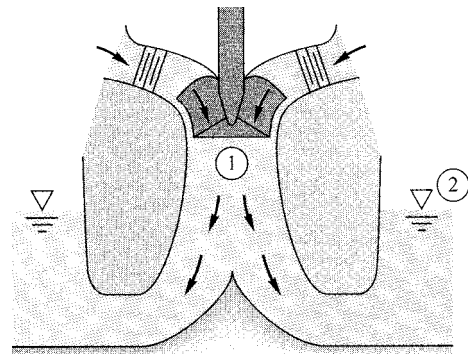


Fig. P11.98

**11.99** Like pumps, turbines can also cavitate when the pressure at point 1 in Fig. P11.98 drops too low. With NPSH defined by Eq. 11.20, the empirical criterion given by Wislicenus [Ref. 4] for cavitation is

$$N_{ss} = \frac{(\text{rpm})(\text{gal/min})^{1/2}}{[\text{NPSH}(\text{ft})]^{3/4}} \geq 11,000$$

Use this criterion to compute how high ( $z_1 - z_2$ ) the impeller eye in Fig. P11.98 can be placed for a Francis turbine, with a head of 300 ft,  $N_{sp} = 40$ , and  $p_a = 14$  psia, before cavitation occurs in 60°F water.

**Solution:** For water at 60°F, take  $\rho g = 62.4$  lbf/ft<sup>3</sup> and  $p_v \approx 37$  psfa = 0.25 psia. Then

$$\text{Eq. 11.20: NPSH} = \frac{p_a - p_v}{\rho g} - \Delta z - h_{fi} = \frac{(14.0 - 0.25)(144)}{62.4} - \Delta z - 0 = 31.7 \text{ ft} - \Delta z$$

Now we need the NPSH, which we find between the two specific-speed criteria:

$$N_{sp} = 40 = \frac{n(P \text{ in hp})^{1/2}}{(300 \text{ ft})^{5/4}} \quad \text{with } P = \eta \rho g (Q/449)(300 \text{ ft}) \div 550$$

$$N_{ss} = 11000 = \frac{n(Q \text{ in gpm})^{1/2}}{(\text{NPSH})^{3/4}}. \quad \text{Iterate to solve by assuming } \eta \approx 90\%$$

(We can't find  $n$  or  $Q$ , only  $nQ^{1/2}$ ). Result:  $\text{NPSH} \approx 45.0$  ft,  $\Delta z = 31.7 - 45 \approx -13.3$  ft. *Ans.*

**11.100** One of the largest wind generators in operation today is the ERDA/NASA two-blade propeller HAWT in Sandusky, Ohio. The blades are 125 ft in diameter and reach maximum power in 19 mi/h winds. For this condition estimate (a) the power generated in kW, (b) the rotor speed in r/min, and (c) the velocity  $V_2$  behind the rotor.

**Solution:** For air in Ohio (?), take  $\rho \approx 0.0023$  slug/ft<sup>3</sup>. Convert 19 mi/h = 27.9 ft/s. From Fig. 11.34 for the propeller HAWT, read optimum power coefficient and speed ratio:

$$C_{P,\max} \approx 0.46 = \frac{P}{(1/2)\rho A V_1^3} = \frac{P_{\max}}{(1/2)(0.0023)(\pi/4)(125)^2(27.9)^3}$$

$$\text{Solve for } P_{\max} \approx 1.4\text{E}6 \text{ ft}\cdot\text{lbf/s} \approx \mathbf{190 \text{ kW}} \quad \text{Ans. (a)}$$

$$\left. \frac{\omega r}{V_1} \right|_{\text{optimum}} \approx 5.7 = \frac{\omega(125/2)}{27.9}, \quad \text{or } \omega \approx 2.54 \frac{\text{rad}}{\text{s}} \times \frac{60}{2\pi} \approx \mathbf{24 \text{ rpm}} \quad \text{Ans. (b)}$$

$$\text{From ideal-windmill theory, } V_{\text{behind}} = V_2 = \frac{1}{3} V_1 = \frac{27.9}{3} \approx \mathbf{9.3 \text{ ft/s}} \quad \text{Ans. (c)}$$

**11.101** A Darrieus VAWT in operation in Lumsden, Saskatchewan, that is 32 ft high and 20 ft in diameter sweeps out an area of 432 ft<sup>2</sup>. Estimate (a) the maximum power and (b) the rotor speed if it is operating in 16 mi/h winds.

**Solution:** For air in Saskatchewan (?), take  $\rho \approx 0.0023$  slug/ft<sup>3</sup>. Convert 16 mi/h = 23.5 ft/s. From Fig. 11.34 for the Darrieus VAWT, read optimum  $C_P$  and speed ratio:

$$C_{P,\max} \approx 0.42 = \frac{P}{(1/2)\rho AV_1^3} = \frac{P_{\max}}{(1/2)(0.0023)(432)(23.5)^3}$$

$$\text{Solve for } P_{\max} \approx 2696 \text{ ft}\cdot\text{lbf/s} \approx \mathbf{3.7 \text{ kW}} \quad \text{Ans. (a)}$$

$$\text{At } P_{\max}, \frac{\omega r}{V_1} \approx 4.1 = \frac{\omega(20/2)}{23.5}, \quad \text{or: } \omega \approx 9.62 \frac{\text{rad}}{\text{s}} \times \frac{60}{2\pi} \approx \mathbf{92 \text{ rpm}} \quad \text{Ans. (b)}$$

**11.102** An American 6-ft diameter multiblade HAWT is used to pump water to a height of 10 ft through 3-in-diameter cast-iron pipe. If the winds are 12 mi/h, estimate the rate of water flow in gal/min.

**Solution:** For air in America (?), take  $\rho \approx 0.0023$  slug/ft<sup>3</sup>. Convert 12 mi/h = 17.6 ft/s. For water, take  $\rho = 1.94$  slug/ft<sup>3</sup> and  $\mu = 2.09\text{E-}5$  slug/ft·s. From Fig. 11.34 for the American multiblade HAWT, read optimum  $C_P$  and speed ratio:

$$C_{P,\max} \approx 0.29 \text{ at } \frac{\omega r}{V_1} \approx 0.9: \quad P_{\max} \approx 0.29 \left( \frac{1}{2} \right) (0.0023) \frac{\pi}{4} (6)^2 (17.6)^3 \approx 51.4 \frac{\text{ft}\cdot\text{lbf}}{\text{s}}$$

$$\text{If } \eta_{\text{pump}} \approx 80\%, \quad P_{\text{pump}} \approx 0.8(51.4) = \rho_{\text{water}} g Q H_{\text{sys}} = 62.4 Q \left( \Delta z + f \frac{L}{D} \frac{V_{\text{pipe}}^2}{2g} \right)$$

$$\text{where } V_{\text{pipe}} = \frac{Q}{(\pi/4)(3/12)^2}, \quad \frac{L}{D} = \frac{10}{3/12} = 40, \quad \frac{\epsilon}{D} = \frac{0.00085}{3/12} \approx 0.0034$$

Clean up to:  $0.659 = Q(10 + 258f_{\text{Moody}}Q^2)$ , with  $Q$  in ft<sup>3</sup>/s. Iterate to obtain

$$f \approx 0.0305, \quad V_{\text{pipe}} \approx 1.34 \frac{\text{ft}}{\text{s}}, \quad \text{Re} \approx 31000, \quad Q \approx 0.0657 \frac{\text{ft}^3}{\text{s}} \approx \mathbf{29 \text{ gal/min}} \quad \text{Ans.}$$

**11.103** A very large Darrieus VAWT was constructed by the U.S. Department of Energy near Sandia, New Mexico. It is 60 ft high and 30 ft in diameter, with a swept area of 1200 ft<sup>2</sup>. If the turbine is constrained to rotate at 90 r/min, use Fig. 11.34 to plot the predicted power output in kW versus wind speed in the range  $V = 5$  to 40 mi/h.

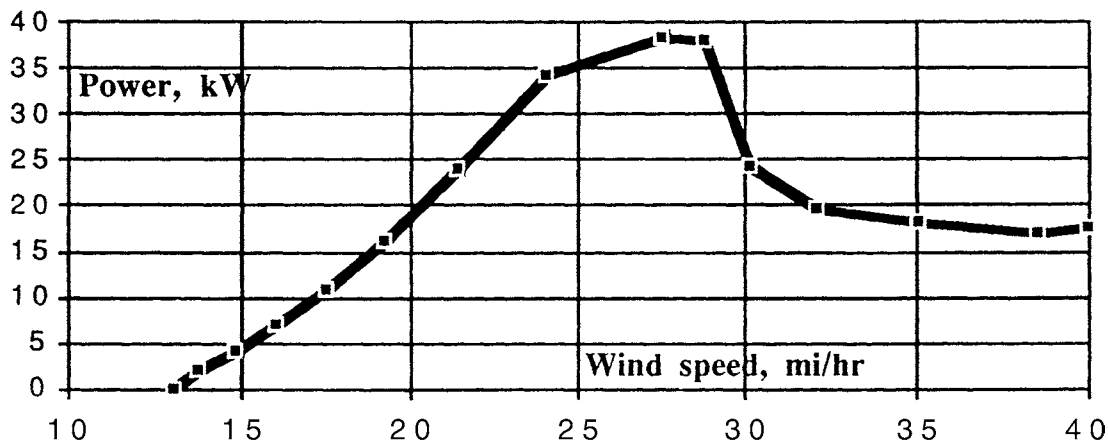
**Solution:** For air in New Mexico (?), take  $\rho \approx 0.0023 \text{ slug/ft}^3$ . Given  $r = 15 \text{ ft}$  and  $\omega = 90 \text{ rpm} = 9.43 \text{ rad/s}$ , we can select wind speed  $V$ , hence  $\omega r/V$  is known, read  $C_p$ , hence the power can be computed. For example,

$$\text{Select } \frac{\omega r}{V_1} = 3.0 = \frac{9.43(15)}{V_1}, \text{ hence } V_1 = 47.1 \text{ ft/s} = 32.1 \text{ mi/h}$$

$$\text{Read } C_p \approx 1.0 = \frac{P}{(1/2)\rho A V_1^3} = \frac{P}{(1/2)(0.0023)(1200)(47.1)^3},$$

$$\therefore P \approx 14400 \frac{\text{ft}\cdot\text{lbf}}{\text{s}} \approx 19.6 \text{ kW}$$

Continue this across the entire “Darrieus VAWT” curve in Fig. 11.34 until you span the entire wind-speed range of 5 to 40 mi/h. The curve obtained by the writer is shown below. The rotor gives zero power for  $V \leq 13 \text{ mi/h}$  and gives power in the range of 18 to 38 kW for  $20 < V < 40 \text{ mi/h}$ . *Ans.*



## COMPREHENSIVE PROBLEMS

**C11.1** The net head of a little aquarium pump is given by the manufacturer as a function of volume flow rate as listed:

$Q, \text{ m}^3/\text{s}$ :	0	1E-6	2E-6	3E-6	4E-6	5E-6
$H, \text{ mmH}_2\text{O}$ :	1.10	1.00	0.80	0.60	0.35	0.0

What is the maximum achievable flow rate if you use this pump to pump water from the lower reservoir to the upper reservoir as shown in the figure?

NOTE: The tubing is smooth, with an inner diameter of 5 mm and a total length of 29.8 m. The water is at room temperature and pressure, and minor losses are neglected.

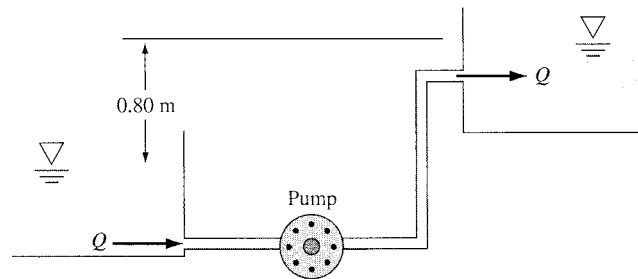


Fig. C11.1

**Solution:** For water, take  $\rho = 998 \text{ kg/m}^3$  and  $\mu = 0.001 \text{ kg/m}\cdot\text{s}$ . NOTE: The tubing is so small that the flow is *laminar*, even at the highest pump flow rate:

$$Re_{\max} = \frac{4\rho Q_{\max}}{\pi\mu d} = \frac{4(998)(5E-6)}{\pi(0.001)(0.005)} = 1270 < 2000 \quad \therefore \text{Laminar}$$

The energy equation shows that the pump must fight both friction and elevation:

$$H_{\text{pump}} = \Delta z + f \frac{L}{d} \frac{V^2}{2g} = \Delta z + h_{f,\text{laminar}} = \Delta z + \frac{128\mu L Q}{\pi d^4 \rho g} = 0.8 + \frac{128(.001)(29.8)Q}{\pi(0.005)^4(998)(9.81)},$$

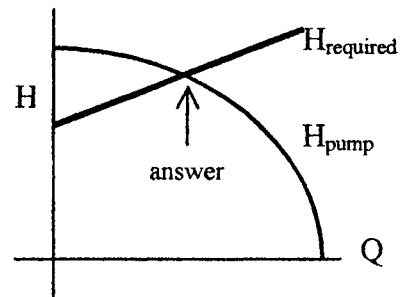
$$\text{or: } H_p = 0.8 + 198400Q = H_p(Q) \quad \text{from the pump data above}$$

One can plot the two relations, as at right, or use EES with a look-up table to get the final result for flow rate and head:

$$H_p = 1.00 \text{ m}$$

$$Q = 1.0E-6 \text{ m}^3/\text{s} \quad \text{Ans.}$$

The EES print-out gives the results  $Re_d = 255$ ,  $H = 0.999 \text{ m}$ ,  $Q = 1.004E-6 \text{ m}^3/\text{s}$ .



**C11.2** Reconsider Prob. 6.62 as an exercise in pump selection. Select an impeller size and rotational speed from the Byron Jackson pump family of Prob. 11.28 which will deliver a flow rate of  $3 \text{ ft}^3/\text{s}$  to the system of Fig. P6.62 at minimum input power. Calculate the horsepower required.

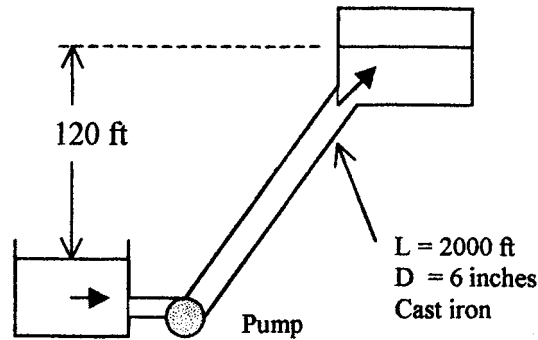


Fig. C11.2

**Solution:** For water take  $\rho = 1.94 \text{ slug/ft}^3$  and  $\mu = 2.09\text{E-}5 \text{ slug/ft}\cdot\text{s}$ . For cast iron take  $\varepsilon = 0.00085 \text{ ft}$ , or  $\varepsilon/d = 0.00085/0.5 = 0.0017$ . The energy equation, written between reservoirs, is the same as in Prob. 6.62:

$$H_p = \Delta z + f \frac{L}{d} \frac{V^2}{2g} = 120 \text{ ft} + f \frac{2000}{0.5} \frac{[Q/(\pi/4)/(0.5)]^2}{2(32.2)} = 120 + 1611fQ^2$$

$$\text{where } f = f_{\text{Moody}} = f_{\text{cn}}\left(Re_d, \frac{\varepsilon}{d}\right) \text{ with } Re_d = \frac{4\rho Q}{\pi\mu d}$$

If, as given,  $Q = 3 \text{ ft}^3/\text{s}$ , then, from above,  $f = 0.0227$  and  $H_p = 449.6 \text{ ft}$ .

Now we have to *optimize*: From Prob. 11.28,  $Q^* = 6 \text{ ft}^3/\text{s}$ ,  $H^* = 330 \text{ ft}$ , and  $P^* = 255 \text{ bhp}$  when  $n = 2134 \text{ rpm}$  (35.57 rps) and  $D = 14.62 \text{ inches}$  (1.218 ft). Thus, at BEP:

$$C_Q^* = \frac{Q^*}{nD^3} = 0.0933; \quad C_H^* = \frac{gH^*}{n^2D^2} = 5.66; \quad C_P^* = \frac{P^*}{\rho n^3D^5} = 0.599$$

For the system above,  $(3.0)/[nD^3] = 0.0932$ , or  $nD^3 = 32.15$ , and  $(32.2)(449.6)/n^2D^2 = 5.66$ , or  $n^2D^2 = 2558$ . Solve simultaneously:

$$n = 63.4 \text{ rps} = 3800 \frac{\text{rev}}{\text{min}}; \quad D_p = 0.798 \text{ ft}; \quad \text{Power} = 0.599 \rho n^3 D_p^5 = \mathbf{174 \text{ hp}} \quad \text{Ans.}$$

**C11.3** Reconsider Prob. 6.77 as an exercise in turbine selection. Select an impeller size and rotational speed from the Francis turbine family of Fig. 11.21d which will deliver maximum power generated by the turbine. Calculate the water turbine power output and remark on the practicality of your design.

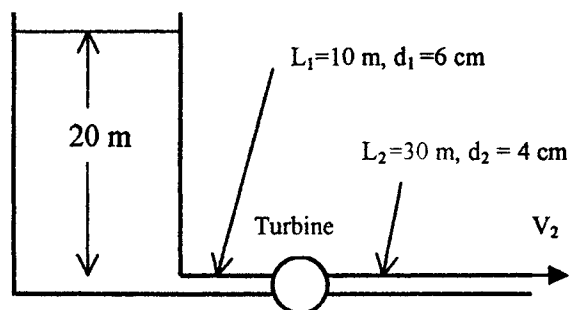


Fig. C11.3

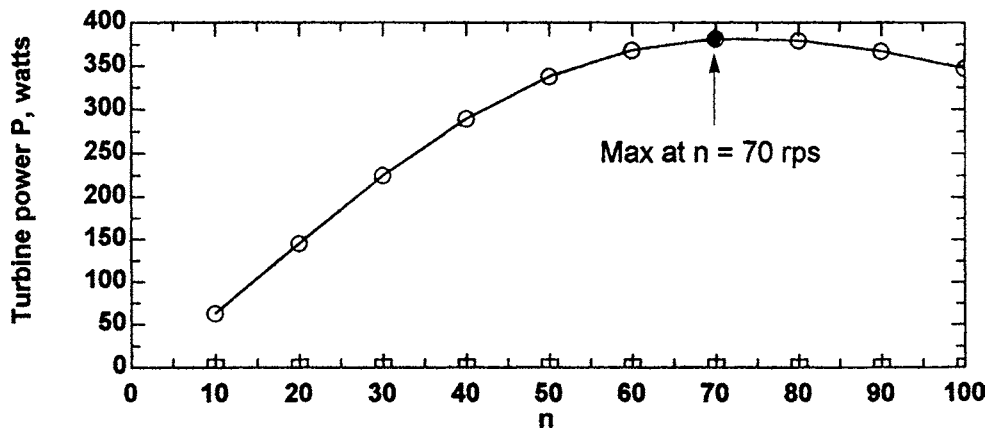
**Solution:** For water, take  $\rho = 998 \text{ kg/m}^3$  and  $\mu = 0.001 \text{ kg/m}\cdot\text{s}$ . For wrought iron take  $\varepsilon = 0.046 \text{ m}$ , or  $\varepsilon/d_1 = 0.046/60 = 0.000767$  and  $\varepsilon/d_2 = 0.046/40 = 0.00115$ . The energy and continuity equations yields

$$\Delta z = 20 \text{ m} = \frac{V_2^2}{2g} + f_1 \frac{L_1}{d_1} \frac{V_1^2}{2g} + f_2 \frac{L_2}{d_2} \frac{V_2^2}{2g} + h_{\text{turbine}}; \quad V_2 = V_1 \left( \frac{d_1}{d_2} \right)^2 = 2.25V_1$$

with the friction factors to be determined by the respective Reynolds numbers and roughness ratios. We use the BEP coefficients from Eq. (11.36) for this turbine:

$$C_Q^* = \frac{Q^*}{nD_t^3} = 0.34; \quad C_H^* = \frac{gH^*}{n^2D_t^2} = 9.03; \quad C_P^* = \frac{P^*}{\rho n^3D_t^5} = 2.70$$

We know from Prob. 6.76 that the friction factors are approximately 0.022. With only *one* energy equation (above) and *two* unknowns ( $n$  and  $D_t$ ), we vary, say,  $n$  from 0 to 100 rev/s and find the resulting turbine diameter and power extracted. The power is shown in the graph below, with a maximum of **381 watts** at  $n = 70 \text{ rev/s}$ , with a resulting turbine diameter  $D_t = 5.3 \text{ cm}$ . This is a fast, small turbine! *Ans.*



**C11.4** The system of Fig. C11.4 is designed to deliver water at  $20^\circ\text{C}$  from a sea-level reservoir to another through new cast iron pipe of diameter 38 cm. Minor losses are  $\sum K_1 = 0.5$  before the pump entrance and  $\sum K_2 = 7.2$  after the pump exit. (a) Select a pump from either Figs. 11.7a or 11.7b, running at the given speeds, which can perform this task at maximum efficiency. Determine (b) the resulting flow rate; (c) the brake horsepower; and (d) whether the pump as presently situated is safe from cavitation.

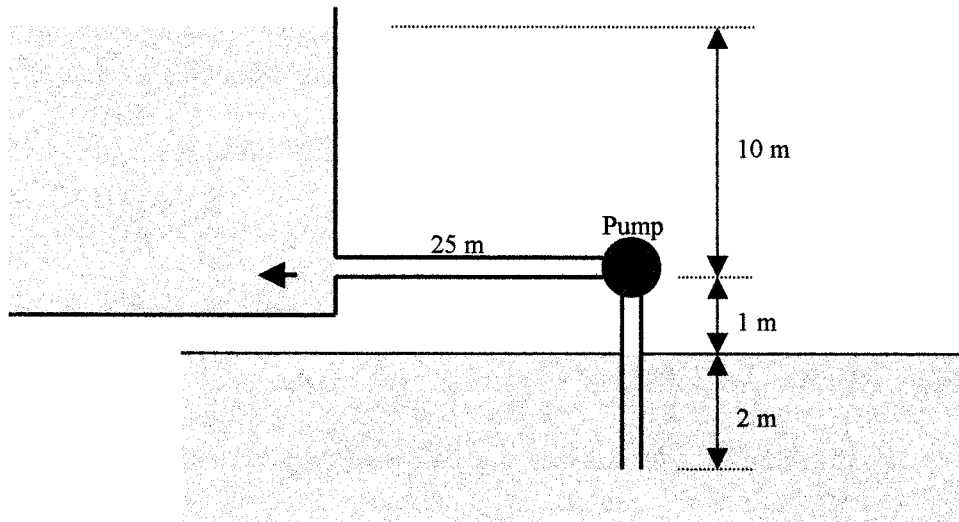


Fig. C11.4

**Solution:** For water take  $\rho = 998 \text{ kg/m}^3$  and  $\mu = 0.001 \text{ kg/m}\cdot\text{s}$ . First establish the *system curve* of head loss versus flow rate. For cast iron take  $\varepsilon = 0.26 \text{ mm}$ , hence  $\varepsilon/d = 0.26/380 = 0.000684$ . The pumps of Figs. 11.7*a,b* deliver flows of 4000 to 28000 gal/min, no doubt turbulent flow. The energy equation, written from the lower free surface to the upper surface, gives

$$\frac{p_1}{\rho g} + \frac{V_1^2}{2g} + z_1 = 0 + 0 + 0 = \frac{p_2}{\rho g} + \frac{V_2^2}{2g} + z_2 + h_f - H_{\text{pump}} = 0 + 0 + 11 \text{ m} + \frac{V_{\text{pipe}}^2}{2g} \left( f \frac{L}{d} \sum K \right)$$

$$\text{Where } f^{-1/2} = -2.0 \log_{10} \left( \frac{\varepsilon/d}{3.7} + \frac{2.51}{\text{Re}_d \sqrt{f}} \right), \quad \text{Re}_d = \frac{\rho V_{\text{pipe}} d}{\mu} \quad \text{and} \quad V_{\text{pipe}} = \frac{Q}{(\pi/4)d^2}$$

Take, for example,  $Q = 22,000 \text{ gal/min} = 1.39 \text{ m}^3/\text{s}$ . Then  $V_{\text{pipe}} = 12.24 \text{ m/s}$ ,  $\text{Re}_d = 4.64\text{E}6$ ,  $f = 0.0180$ , hence the head loss becomes

$$h_f = \frac{(12.24)^2}{2(9.81)} \left[ (0.0180) \left( \frac{28 \text{ m}}{0.38 \text{ m}} \right) + 0.5 + 7.2 \right] = 68.9 \text{ m} = 226 \text{ ft},$$

$$\text{Thus a match requires } H = h_f + z_2 = 68.9 \text{ m} + 11 \text{ m} = 79.9 \text{ m} = 262 \text{ ft}$$

No pump in Fig. 11.7 exactly matches this, but the 28-inch pump in Fig. 11.7*a* and the 41.5-inch pump in Fig. 11.7*b* are pretty close, especially the latter. We can continue the calculations:

$Q$ , gal/min:	4000	8000	12000	16000	<b>20000</b>	22000	24000	28000
$h_f$ , ft:	44	66	103	156	<b>223</b>	262	305	402



(a) The best match seems to be **the 38-inch pump of Fig. 11.7b at a flow rate of 20,000 gal/min**, near maximum efficiency of 88%. *Ans. (a)*

(b, c) The appropriate flow rate is **20,000 gal/min**. *Ans. (b)*

The horsepower is **1250 bhp**. *Ans. (c)*

(d) Use Eq. (11.20) to check the NPSH for cavitation. For water at 20°C,  $p_v = 2337$  Pa. The velocity in the pipe is  $V = Q/A = 11.13$  m/s. The theoretical minimum net positive suction head is:

$$NPSH = \frac{p_a}{\gamma} - z_i - h_{fi} - \frac{p_v}{\gamma} = \frac{101350 \text{ Pa}}{9790 \text{ N/m}^3} - 1 \text{ m} - \frac{(11.13 \text{ m/s})^2}{2(9.81 \text{ m/s}^2)}(1 + 0.5) - \frac{2337 \text{ Pa}}{9790 \text{ N/m}^3}$$

$$NPSH = -0.36 \text{ m}$$

In Fig. 11.7b, at  $Q = 20,000$  gal/min, read  $NPSH \approx 16 \text{ m} \gg -0.36 \text{ m}$ ! So this pump, when placed in its present position, **will surely cavitate!** *Ans. (d)* A new pump placement is needed.

**C11.5** In Prob. 11.23, estimate the efficiency of the pump in two ways: (a) read it directly from Fig. 11.7b (for the dynamically similar pump); (b) calculate it from Eq. (11.5) for the actual kerosene flow. Compare your results and discuss any discrepancies.

**Solution:** Problem 11.23 used the 38-inch-pump in Fig. 11.7b to deliver 22000 gal/min of kerosene at 850 rpm. (a) The problem showed that the *dynamically similar water* pump, at 710 rpm, had a flow rate of 18,400 gal/min.

(a) Figure 11.7b: Read  $\eta \approx 88.5\%$  *Ans. (a)*

(b) For kerosene, take  $\rho = 804 \text{ kg/m}^3 = 1.56 \text{ slug/ft}^3$ . The solution to Prob. 11.23 gave a kerosene head of 340 ft and a brake horsepower of 1600 hp. Together with the known flow rate, we can calculate the kerosene efficiency by definition:

$$\eta_{\text{kerosene}} = \frac{\rho_{\text{kerosene}} g Q H}{\text{Power}} = \frac{(1.56)(32.2)(22000/448.83)(340)}{(1600)(550) \text{ ft}\cdot\text{lbf/s}} = 0.95 \text{ or } 95\% \text{ Ans. (b)}$$

This is significantly different from 88.5% in part (a) above. The main reason (the author thinks) is the **difficulty of reading bhp from Fig. 11.7b**. The actual kerosene bhp for Prob. 11.23 is probably about 1700, not 1600. *Ans.*

**C11.6** An interesting turbomachine [58] is the *fluid coupling* of Fig. C11.6, which delivers fluid from a primary pump rotor into a secondary turbine on a separate shaft. Both rotors have radial blades. Couplings are common in all types of vehicle and machine transmissions and drives. The *slip* of the coupling is defined as the dimensionless difference between shaft rotation rates,  $s = 1 - \omega_s/\omega_p$ . For a given percentage of fluid filling, the torque  $T$  transmitted is a function of  $s$ ,  $\rho$ ,  $\omega_p$ , and impeller diameter  $D$ . (a) Non-dimensionalize this function into two pi groups, with one pi proportional to  $T$ . Tests on a 1-ft-diameter coupling at 2500 r/min, filled with hydraulic fluid of density 56 lbm/ft<sup>3</sup>, yield the following torque versus slip data:

Slip, $s$ :	0%	5%	10%	15%	20%	25%
Torque $T$ , ft-lbf:	0	90	275	440	580	680

- (b) If this coupling is run at 3600 r/min, at what slip value will it transmit a torque of 900 ft-lbf?  
 (c) What is the proper diameter for a geometrically similar coupling to run at 3000 r/min and 5% slip and transmit 600 ft-lbf of torque?

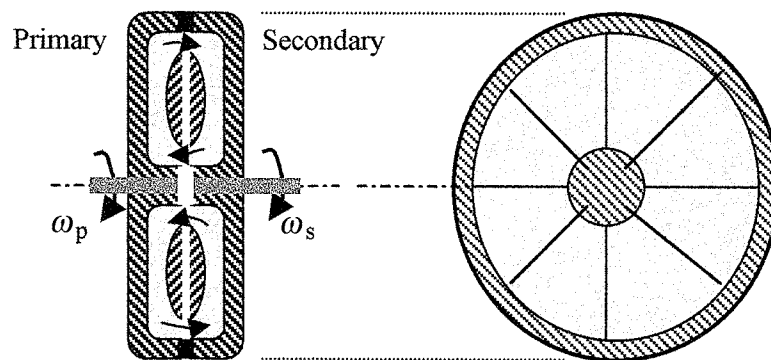


Fig. C11.6

**Solution:** (a) List the dimensions of the five variables, from Table 5.1:

Variable:	$T$	$s$	$\rho$	$\omega_p$	$D$
Dimension:	$\{ML^2/T^2\}$	$\{1\}$	$\{M/L^3\}$	$\{1/T\}$	$\{L\}$

Since  $s$  is already dimensionless, the other four must form a single pi group. The result is:

$$\frac{T}{\rho\omega_p^2 D^5} = \text{fcn}(s) \quad \text{Ans. (a)}$$

Now, to work parts (b) and (c), put the data above into this dimensionless form. Convert  $\rho_{\text{oil}} = 56 \text{ lbm/ft}^3 = 1.74 \text{ slug/ft}^3$ . Convert  $\omega_p = 2500 \text{ r/min} = 41.7 \text{ r/s}$ . The results are:

Slip, $s$ :	0%	5%	10%	15%	20%	25%
$T/(\rho\omega_p^2 D^5)$ :	0	0.0298	0.0911	0.146	0.192	0.225

(b) With  $D = 1$  ft and  $\omega_p = 3500$  r/min = 58.3 r/s and  $T = 900$  ft·lbf,

$$\frac{T}{\rho\omega_p^2 D^5} = \frac{900 \text{ ft}\cdot\text{lbf}}{(1.74 \text{ slug/ft}^3)(58.3 \text{ r/s})^2 (1 \text{ ft})^5} = 0.152, \quad \text{Estimate } s \approx \mathbf{15\%} \quad \text{Ans. (b)}$$

(c) With  $D$  unknown and  $s = 5\%$  and  $\omega_p = 3000$  r/min = 50 r/s and  $T = 600$  ft·lbf,

$$\frac{T}{\rho\omega_p^2 D^5} = \frac{600 \text{ ft}\cdot\text{lbf}}{(1.74 \text{ slug/ft}^3)(50 \text{ r/s})^2 (D)^5} = 0.0298, \quad \text{Solve } \mathbf{D \approx 1.36 \text{ ft}} \quad \text{Ans. (c)}$$

---