

January 1956 • 35 Cents

# *Astounding* SCIENCE FICTION





# DORMIPHONE

*A Great Scientific Discovery*

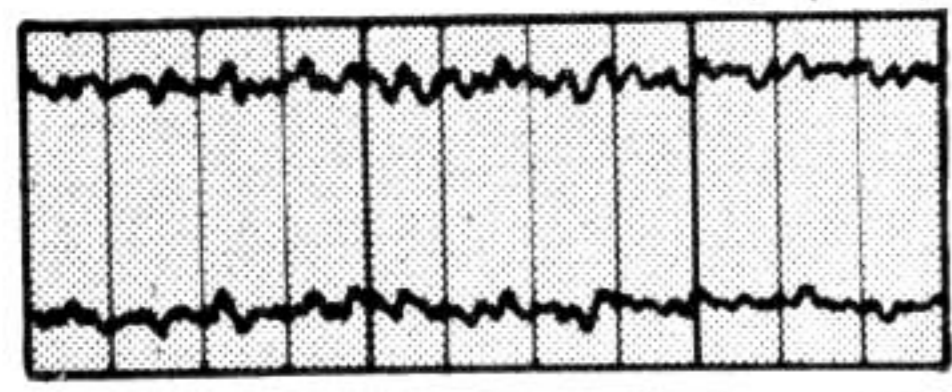

Brain in concentrated thought.

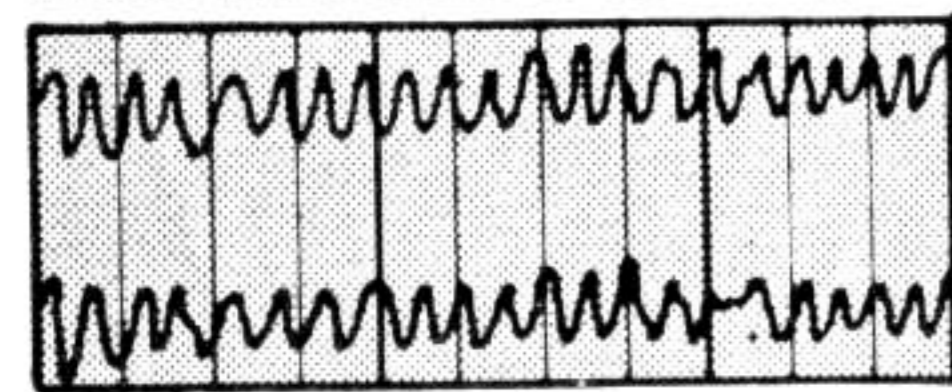

Brain in relaxation.

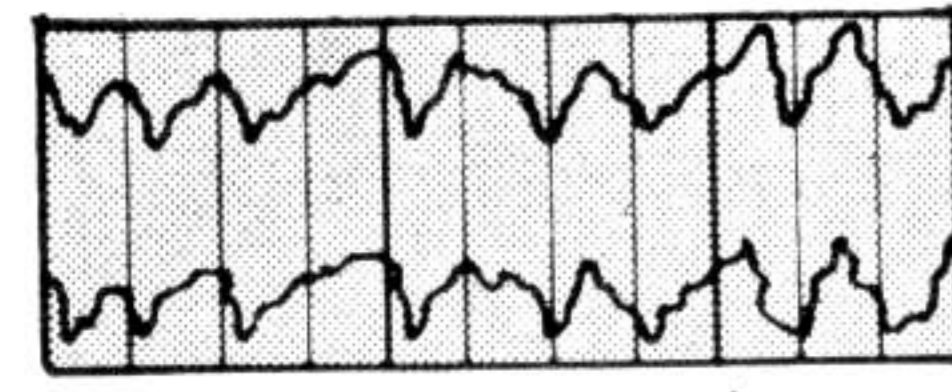

Brain while person sleeps.

## A Revolutionary Invention for Faster Learning

Would you like to increase your rate of learning 20% to 50% by making use of periods of relaxation and sleep? Now it is easy to master a new language, improve your speech, memorize a role in a play, learn useful facts and figures with less time, less effort.

Invention of an ingenious device, DORMIPHONE, by Max Sherover, president of the famous Linguaphone Institute, turned an age-old theory into fact and opened up a new and fascinating avenue of scientific exploration. This new science, called Dormiphonics, is used by educators and psychologists in University laboratories around the world. Their experiments indicate that all of us may soon be able to get an education while we sleep.

### VITAL TO EVERY HUMAN BEING

Scientific experiments have demonstrated that the part of your sleeping brain which stays awake, hears and remembers iterated speech during sleep—that anything to be memorized can be mastered in less time with the aid of DORMIPHONE.

### FIND OUT ABOUT DORMIPHONE

DORMIPHONE has freed scientists from guesswork in the study of sleep. Years of primary research have gone into the soporific principle on which the device is based. Now it is ready to turn the one-third of your life you waste sleeping into useful learning time.

### SEND COUPON FOR FREE BOOKLET

Investigate DORMIPHONE at once. Call for FREE DEMONSTRATION or write for FREE booklet on Dormiphonics by Max Sherover. Get the background, the facts, the evidence, the fascinating potentialities of this revolutionary development.

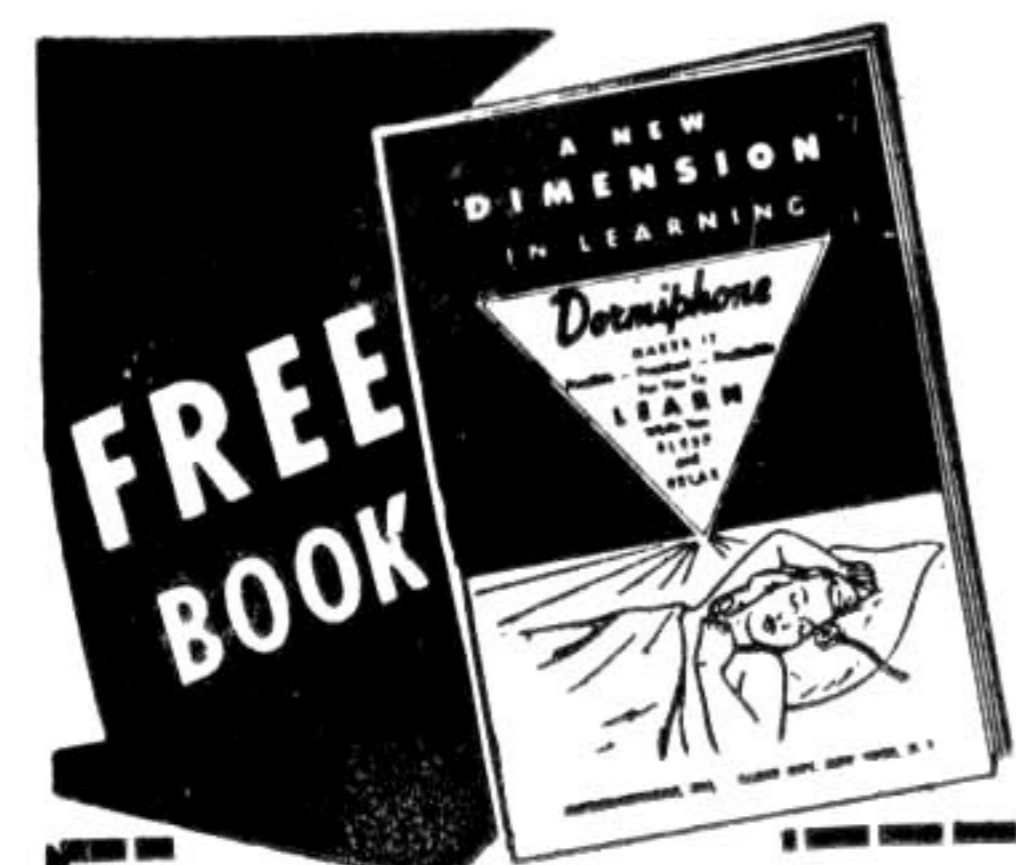

**WRITE TODAY FOR FREE BOOKLET**

**MODERNOPHONE, Inc. (Dormiphone Div.)**  
**159-016 Rock. Plaza, New York 20, N. Y.**

Gentlemen: Send me your FREE Booklet. I am interested in learning more about DORMIPHONE and what it will do for me.

If under 18, check here for Special Booklet A.

NAME \_\_\_\_\_

ADDRESS \_\_\_\_\_

CITY \_\_\_\_\_ ZONE \_\_\_\_\_ STATE \_\_\_\_\_

*My main interest in Dormiphonics is for*

- |  |   |
|--|---|
| <input type="checkbox"/> Learning a Language | <input type="checkbox"/> Speech Improvement |
| <input type="checkbox"/> Memorization        | <input type="checkbox"/> Sleep Inducement   |

# Dormiphone

**MODERNOPHONE, INC.**  
**159-016 Rock. Plaza, New York 20, N. Y.**

"X MINUS ONE" =

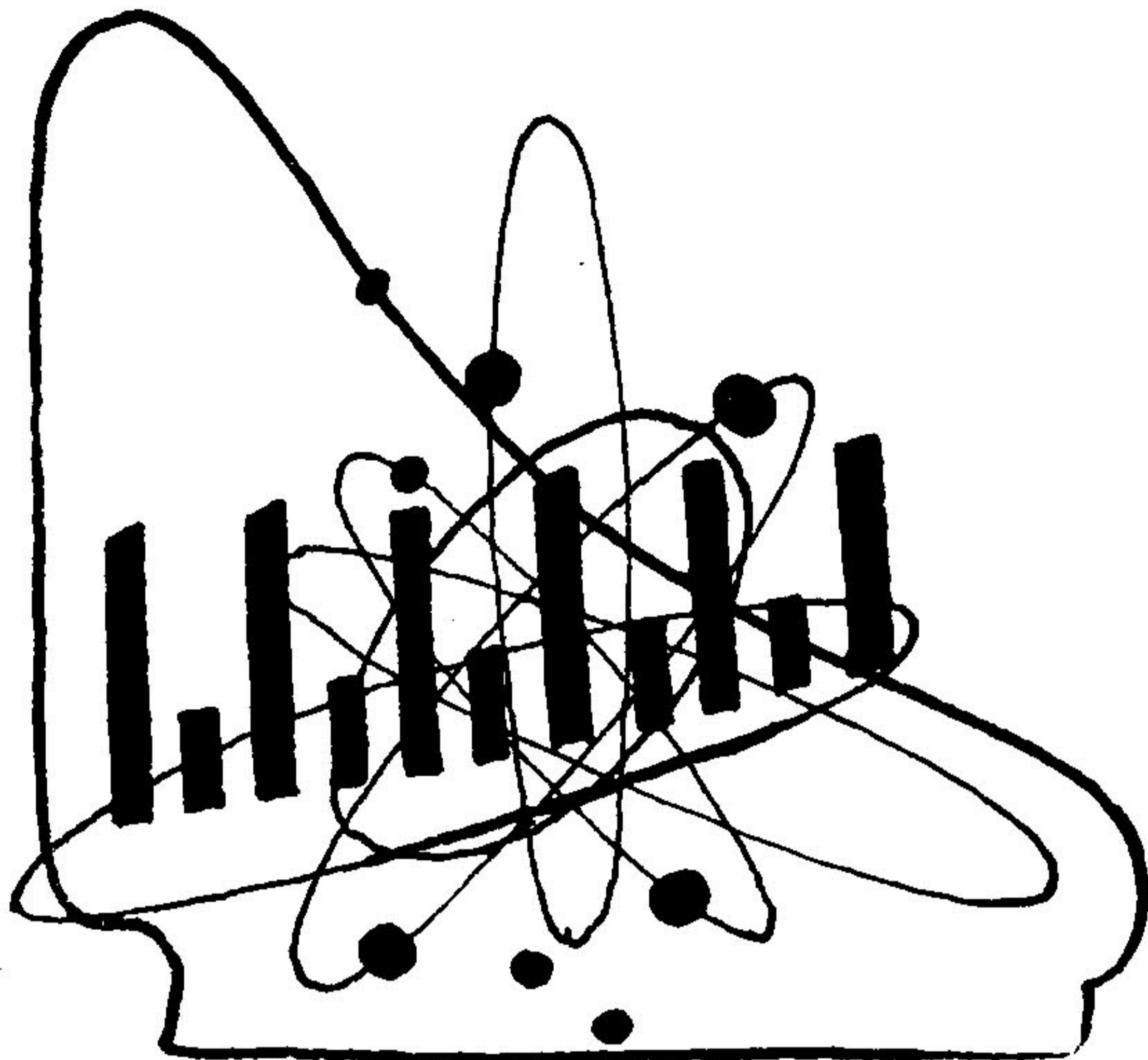

## IMPRESSIONISM

As Stan Kenton is to the field of modern music with continual experiments that almost defy technical explanation, so it is with "X Minus One"—experiments in *adventure* that are new, vigorous and refreshingly different.

"X Minus One" is the unusual science fiction radio series designed exclusively for adults that searches for the different and fresh approach to dramatic works in future tense. It is heard on NBC Radio every Wednesday evening through the combined efforts of NBC and ASTOUNDING SCIENCE FICTION Magazine.

Every story is a science fiction masterwork excitingly dramatized. Every program is precisely worked out for the maximum of interest and entertainment.

Consult your newspaper for program time on your local NBC Radio Station.

For the best in science fiction—

- *Read* ASTOUNDING each month
- *hear* "X MINUS ONE" every Wednesday evening on the



Radio NETWORK

a service of



# Astounding SCIENCE FICTION

VOLUME LVI • NUMBER 5

January 1956

## Novelettes

- The Executioner . . . . . *Algis Budrys* 8  
Won't You Walk— . . . . . *Theodore Sturgeon* 56

## Short Story

- Indirection . . . . . *Everett B. Cole* 39

## Serial

- Under Pressure . . . . . *Frank Herbert* 80  
(Conclusion)

## Article

- Labor of Love . . . . . *Murray Leinster* 136

## Readers' Departments

- The Editor's Page . . . . . 6  
In Times to Come . . . . . 135  
The Reference Library . . . . . *P. Schuyler Miller* 147

Editor: JOHN W. CAMPBELL, JR.  
Advertising Director: ROBERT E. PARK

Assistant Editor: KAY TARRANT  
Advertising Manager: WALTER J. McBRIDE

COVER BY VAN DONGEN • Illustrations by Freas, Rogers and van Dongen

The editorial contents have not been published before, are protected by copyright and cannot be reprinted without publisher's permission. All stories in this magazine are fiction. No actual persons are designated by name or character. Any similarity is coincidental.

*Astounding* SCIENCE FICTION published monthly by Street & Smith Publications, Incorporated at 575 Madison Avenue, New York 22, New York. Arthur Z. Gray, President; Ralph R. Whittaker, Jr., Executive Vice-President, Arthur P. Lawler, Vice-President and Secretary; Thomas H. Kaiser, Treasurer. © 1955 by Street & Smith Publications, Inc., in the United States and countries signatory to the Berne Convention and Pan American Convention. Entered as Second-Class matter at the Post Office, New York, N. Y. Subscription \$3.50 for one year and \$6.00 for two years in United States, Possessions and Canada; \$4.75 for one year and \$8.00 for two years in Pan American Union, Philippine Islands and Spain. Elsewhere \$5.00 for one year and \$8.50 for two years. When possible allow four weeks for change of address. Give old address and new address when notifying us. We cannot accept responsibility for unsolicited manuscripts or art work. Any material submitted must include return postage. All subscriptions should be addressed to Subscription Dept., Street & Smith Publications, Incorporated, 304 East 45th Street, New York 17, New York.

\$3.50 per Year in U. S. A.

Printed in  173 the U. S. A.

35 cents per Copy

4 • NEXT ISSUE ON SALE JANUARY 17, 1956 •

# Can you think faster than this Machine?

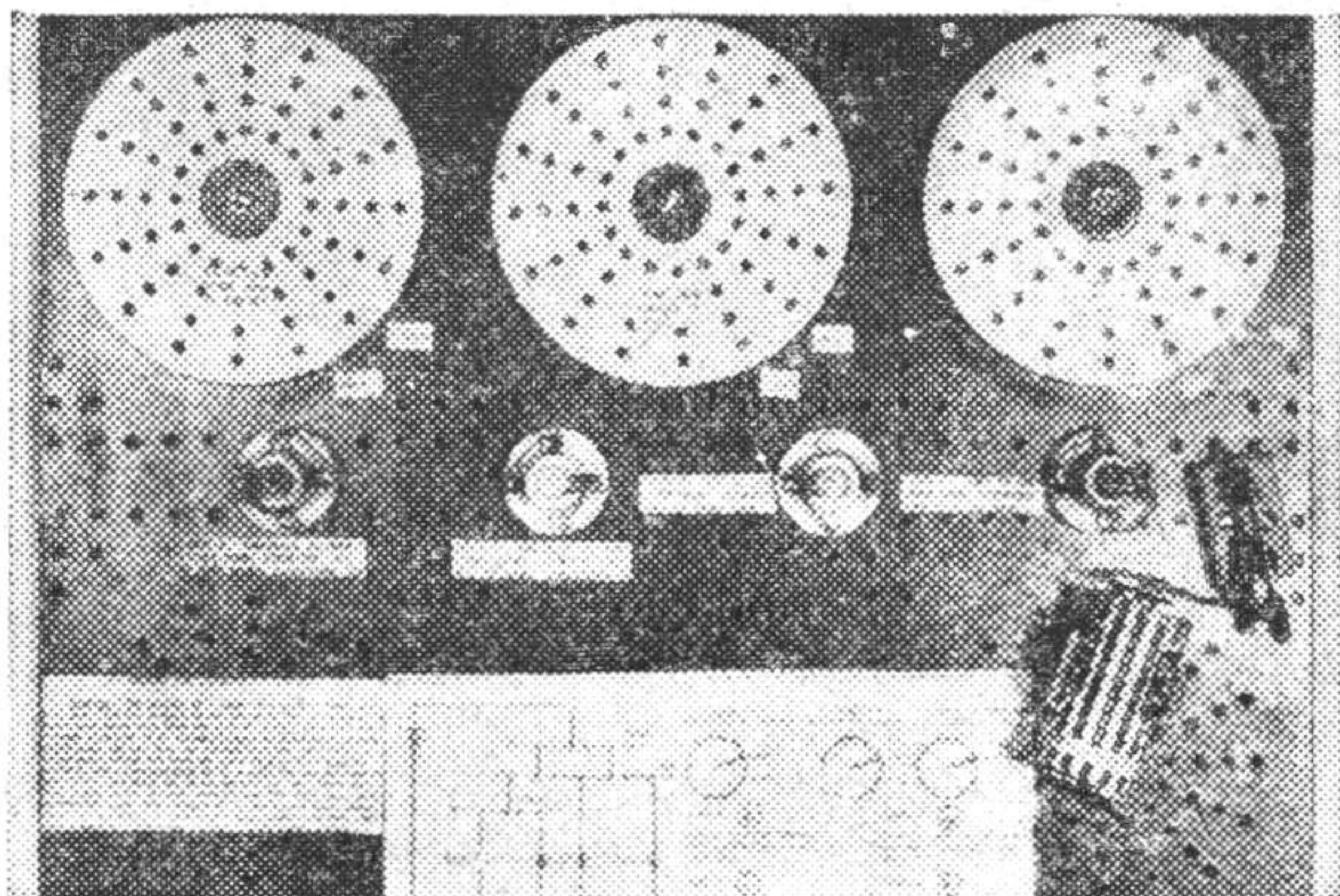

Control Panel of GENIAC  
set up to do a problem  
in space ship engineering

Be careful before you answer. GENIAC the first electrical brain construction kit is equipped to play tic-tac-toe, cipher and encipher codes, convert from binary to decimal reason in syllogisms, as well as add, subtract, multiply and divide. Specific problems in a variety of fields—actuarial, policy claim settlement, physics, etc., can be set up and solved with the components. Connections are solderless and are completely explained with templates in the manual. This covers 33 circuits and shows how new ones can be designed.

You will find building and using GENIACS a wonderful experience; one kit user wrote us: "this kit has opened up a new world of thinking to me." You actually see how computing, problem solving, and game play (Tic-tac-toe, nim, etc.) can be analyzed with Boolean Algebra and the algebraic solutions transformed directly into circuit diagrams. You create from over 400 specially designed and manufactured components a machine that solves problems faster than you can express them.

Schools and colleges, teachers of

science or math, engineering, philosophy or psychology will find these excellent demonstrators of circuitry, solutions in symbolic logic, theory of numbers, cybernetics, and automation.

NOTE: Teachers take advantage of our 10% discount to educational institutions and for group purchases.

Send for your GENIAC kit now. Only \$19.95 with over four hundred components and parts, fully illustrated manual and wiring diagrams. We guarantee that if you do not want to keep GENIAC after two weeks you can return it for full refund plus shipping costs.

## MAIL THIS COUPON

SCIENCE KITS,  
Dept. SL 7, Oliver Garfield Co.  
546 Summit Avenue, Jersey City, N. J.

Please send me:

1 GENIAC Electric Brain Construction  
Kit and Manual.

\$19.95 (East of Mississippi) \_\_\_\_\_

\$20.95 (Elsewhere in United States) \_\_\_\_\_

\$21.95 (Outside the United States) \_\_\_\_\_

Returnable in seven days for full refund if  
not satisfied. I enclose \$\_\_\_\_\_ in full  
payment.

My name and address are attached.

# NOTHING FAILS LIKE SUCCESS

Almost any social scientist will agree to the proposition that one of the great difficulties of the social sciences is that you can't experiment with human beings.

This statement, however, is a blatant fallacy; until we have a fully perfected social science, *we can't do anything else.*

Construction engineers have never been able to experiment with earthquakes, either. Nor have geologists been able to experiment with volcanoes. Nor astronomers with stars. But neither earthquakes, volcanoes, nor stars have any objection to having truths determined and published.

People and societies do.

It isn't that experiments with human beings haven't been conducted; every culture Mankind has ever tried has been an experiment with human beings. Every child ever raised by human parents was an experiment with a human being. Because until there is a true science of

humanics, all living *must* be an experiment with human lives.

Nobody likes being made the victim of an experiment over which he has no control. Since we can't avoid that situation, it's more comfortable to *say* that it isn't an experiment, that we know just how to do it, that we're wise authorities on exactly how it should be done. Every human culture holds firmly that it has all the right answers necessary to successful living, and that all those other cultures around in time and space just aren't as wise as it is.

When the Mormons headed out for Great Salt Lake, they tried an experiment in human cultures. They had some really rugged starting conditions, too—and their experiment was one of the outstanding successes of human history. Starting with a group having far more females than males, they had the courage and sanity to abandon the impracticable cultural concept of monogamy, so that all their people could form co-opera-

tive social units—families. What they accomplished in that barren desert land was a major feat of socio-economic engineering, and a real triumph. Naturally, the second generation had the normal distribution of the male-female birth ratio—and the people had flexibility of understanding enough to reaccept the monogamous cultural custom.

When the first American colonists came over here from Europe, they, too, were trying a cultural experiment. There were a lot of experiments made; the Swedes tried, and the Dutch, the French and Spanish and English. Some worked; some didn't. But they were experiments.

But two things block the social scientist; he wants to work with *controlled* experiments, and human beings do not like discovering home truths that directly attack their own, personal belief-patterns. The social scientist wants to set up an experiment *his* way, so he knows all the factors that go into it.

I imagine an astrophysicist would like to be able to set up a galactic experiment, starting with a million cubic light-years of gas and dust, made up according to exactly the formula he would like to test, and study the reactions. I'm sure vulcanologists would like to set up an experimental volcano, too. They, too, would like to work with *controlled* experiments.

So what? They aren't going to be able to, and they know it. Having accepted that fact, they've gone to

work with the experiments Nature provides.

The social scientist isn't going to be able to set up controlled human experiments for a long, long time to come—probably it'll be forever impossible to set up controlled experiments involving the highest type of intelligent people, by the inherent nature of that group. You cannot control someone who's as smart as, or smarter than, you are; any controls system you can think up, he can counter-think a way out of. *If* you can fully define what the little term "I" means, you'd know all the factors involved, and probably wouldn't need an experiment at that point. Until you can *fully* define the three little words "I like people," you don't know enough to be able to set up a truly controlled experiment anyway. Trying to do so would be presumptuous. When you can fully, operationally, define the term "God," you would be able to set up a controlled human experiment; short of that accomplishment, you aren't ready to try it.

But every human culture tries to pretend it is Godlike; that it has the Ultimate Wisdom, and that its decisions and judgments are Unarguable. With a very, very few exceptions, human cultures claim to be the direct injunctions of the god(s). (Some exceptions; the Roman culture of the latter Empire days deified the emperors, thereby effectively equating gods and men. Currently, the Soviet

(Continued on page 160)

# THE EXECUTIONER

*A man of high courage and deep honesty is always dangerous—but he's twice as dangerous when he is, also, a fool.*

**BY ALGIS BUDRYS**

Illustrated by Freas

Late in the morning, just before noon, Samson Joyce sat in a folding chair placed behind the high, granite judges' bench which faced the plaza. In a few minutes, he would be climbing up the steps of the bench to its top, where he would stand behind the solid parapet and look down at the Accused's box in the plaza. Now he was checking his gun.

He worked the slide, watching the breech open and the extractor reach with its metal fingertip. The bolt drew back; hesitated; jumped forward. He took out a silk rag and wiped off the excess oil, spreading it in a thin, uniform film over the metal. He thumbed the cartridges out of the clip, oiled the clip action,

**ASTOUNDING SCIENCE FICTION**





and reloaded. He did it this with patient care and long practice.

The sun had been breaking in and out of clouds all morning, and there was a fitful wind. The pennants and family standards around the plaza were twisting restlessly. It was an uncertain day.

The gun was his old favorite; a gas-fired 15-millimeter Bogen that had been with him since his old days as Associate Justice of Utica. It fitted comfortably into his hand, as well it might after all these years. It was not the jeweled, plated and engraved antique they expected him to use at the big trials in New York City or Buffalo. It was just a gun; it did what it was meant for, cleanly and efficiently, and he used it whenever he could. It didn't pretend to be more than it was. It never failed.

He scowled, looking down at it. He scowled at feelings he knew were foolish and wished he did not have.

Once he'd been in his twenties, looking forward. Now he was a shade past fifty, and what he looked back on was subtly less satisfactory than what he had looked forward to.

He raised his head and looked at the three men who were his Associate Justices today, as they walked toward him from the hotel. Blanding, with his brief case, Pedersen, with his brief case, and Kallimer with his frown.

Joyce's heavy lower lip tightened in a fleeting touch of amusement that slackened and was gone without a trace. All of them were younger

than he'd been at Utica, and all three were farther along. Blanding was the Associate Justice here in Nyack, which meant his next appointment would take him out of the suburbs and into the city proper. Pedersen was waiting for the results of the Manhattan by-election to be officially confirmed. When they were, he'd take his seat in the Legislature. And Kallimer was Special Associate Justice to the Chief Justice of Sovereign New York, Mr. Justice Samson Ezra Joyce. Perhaps it was the strain of remembering his full title that gave him the permanent frown, drawing his thin eyebrows closer together and pinching the bridge of his bony nose. Or perhaps he was rehearsing the sound of "Chief Justice of Sovereign New York, Mr. Justice Ethan Benoni Kallimer."

All three of them were fortunate young men, in the early flower of their careers. But, being young men, they were not quite capable of enjoying their good fortune. Joyce could guess what they must be feeling as they walked toward him.

They'd be thinking Joyce was a crusty old fool who was hopelessly conservative in his administration of justice—that younger men were more capable.

They'd be thinking he wanted to live forever, without giving someone else a chance. They were sure he thought he was the only one fit to wear a Chief Justice's Trial Suit.

And they called him Old Knock-

Knees whenever they saw him in his Suit tights.

Every trial saw them with their brief cases, each with its gun inside. Each of them waited for the day The Messire reversed Joyce's human and, therefore, fallible verdict. There'd be a new Chief Justice needed for the next trial, and promotions all along the line.

He worked the Bogen slide again, nodded with satisfaction, and replaced the clip. In the thirty years since he'd begun, The Messire had not reversed his verdicts. He had come close—Joyce had scars enough—but, in the end, he'd done no more than raise a formal objection, as it were, before substantiating Joyce's decisions.

Blanding, Pedersen, and Kallimer, in their plain, unfigured black vests, the stark white lace frothing at their wrists, stopped in front of him.

Somber men. Jealous men—even Pedersen, who was leaving the bench. Impatient men.

Joyce put away his gun. Young men, who failed to realize their good fortune in still having a goal to attain, and a dream to fulfill. Who did not foresee that it was the men at the top — the men who had reached the goal—who had to dedicate themselves unceasingly to the preservation of the ideal; who, with The Messire's help, labored each minute of their lives to keep the purpose of their lives untarnished. The young men never knew, until they reached the top, that the joy was in the struggle, and the drudgery

in the maintenance of the victory. The young men served the ideal, without a thought to wondering what kept the ideal high and firm in its purpose.

Some day, they might learn.

"Good morning, Justice," almost in chorus.

"Good morning, Justices. I imagine you slept well?"

From the sound of the spectators, he judged that the Accused had just been brought into the plaza. It was interesting to note the change in crowd voices over the years. Lately, it had been easy to differentiate between the sound from the family boxes and the noise of the people, which was a full octave lower.

Joyce looked up at the plaza tower clock. A few moments remained.

Dissatisfaction? Was that what he felt?

He imagined himself trying to explain what he felt to one of these youngsters, and — yes — "dissatisfaction" was the word he would use.

But that wouldn't ever happen. Blanding was too young to do anything but sneer at the knock-kneed old fool with his swollen ankles. Pedersen was out of it. And Kallimer, of course, whose intelligence he respected, was too intelligent to listen. He had his own ideas.

Joyce stood up. Touched the figure of The Messire buried under his neckpiece, straightened the hang of his vest, adjusted his wig, and turned toward his Associates. In so doing, he allowed his glance to quickly sweep over the Accused for the first

time. She was standing in her box, waiting. Just one glance, before she could realize he'd compromised his dignity by looking at her.

"Well, Justices, it's time."

He waited to follow them up the steps which would be hard on his ankles.

First, Blanding had to relinquish his right to try the case, since it was in his jurisdiction.

Joyce, standing by himself on the higher central section of the platform, leaned forward slightly until his thighs were pressed against the cool stone of the bench's back. It took some of the weight off his ankles.

No one would notice it from the plaza below. Looking up at the bluff gray wall of the bench's face, all anyone could see were the torsos of four men; two in black, then one standing somewhat taller in his brilliant Suit, and then another in black. That last was Blanding, and now he stepped around the end of the bench, forward onto the overhanging slab that was the bailiff's rostrum at ordinary trials, and stopped, slim, motionless, and black, standing out over the plaza below.

Joyce was grateful for the breeze. The Suit was heavy with its embroidered encrustations, and the thick collar, together with his neckpiece, was already making him perspire. Still and all, he did not regret coming here to Nyack. In New York and Buffalo, his trials were ostentatious ceremonials, overrun with

minor functionaries and elaborate protocol toward the First Families. Here in Nyack, there were no functionaries and no First Families. The ceremony of trial could be stripped down to its simple but beautiful essentials. Blanding would handle the statements of charges, Pedersen would keep track, and Kallimer . . .

Kallimer would wait to see whether The Messire approved.

Joyce looked down at the crowd. Scarlet, gold, and azure blue struck his eyes from the family boxes. He saw the flash of light on rings and earrings, the soft, warm color of the ladies' wimples.

The people were a dun mass, dressed in the dark, subdued colors they had been affecting lately. Joyce reflected that, without their contrast, the family members might not appear so brilliant in their boxes. But that was only a hasty digression, fluttering across his mind like an uneasy bird at sunset.

He understood from Blanding that the people had some unusual interest in this trial. Looking down, he could see the crowd was large.

Joyce plainly heard Blanding draw breath before he began to speak. When he did, he spoke slowly, and the acoustic amplifiers inside the stone bench made his voice grave and sonorous.

"People of Nyack—"

The crowd became absolutely still, all of them watching the straight, motionless black figure standing above them.

This was justice, Joyce thought

as he always did when a trial began, the mood slipping over him. This was the personification of the ideal. The straight, unbending figure; the grave voice.

"The Nyack Court of Common Justice, of Sovereign New York, is now in Session."

He disliked Blanding, Joyce reflected, watching the Associate half-turn and extend an arm toward him. He disliked Pedersen, and Kallimer made him uneasy. But they were together in this. This was above personality, and above humanity. The Messire, the four of them, the families and the people; together, what they did here today was their bond and heritage. This was their bulwark against savagery.

Blanding had held the gesture just long enough. "Mr. Justice Joyce, Chief Justice of Sovereign New York, Presiding."

There was a burst of excited applause from the families. They'd expected him to preside at a trial of this nature, of course, but they were excited now, nevertheless. This was the official stamp. This was the recognition of their importance, and of the importance of this case. Joyce bowed his head in acknowledgment.

"Mr. Justice Kallimer, Chief Associate Justice."

Joyce noted that Kallimer's applause was much more sparse. But then, he had almost no reputation here. He'd originally come from Waverly, which was far across the nation at the Pennsylvania border. He'd been noticed by the Bar As-

sociation, but until he'd presided at some trials in the Hudson area, very few people would recognize his name.

"Mr. Justice Pedersen, Recording Justice."

Pedersen drew a better hand than Kallimer. That was because he was a New York City judge.

Joyce did not permit his thin smile to touch his face. For all of that, it was Kallimer who would succeed him, even if Pedersen had stayed on the bench. Kallimer was not a crowd-pleaser, but he had been efficient in Waverly, and he could be efficient here, too, if he had to.

Joyce waited for the proper amount of expectant silence to accumulate. Then he raised his head.

"Let trial begin."

There was a fresh burst of applause. When it subsided, he turned to Blanding. "Justice Blanding will state the case." Joyce's tone, too, was deep and majestic. Part of that was the amplifiers, doing their invisible work within the bench, but part of it was in him, and he found himself submerging in the mood of the trial, his back stiffening and his ankles taking his full weight. His head was erect, and he felt his slow pulse moving regularly through his veins, beating with the gratification of the act of trial.

Blanding looked down at the Accused's box.

"The case of John Doe in complaint against Clarissa Jones. The concurrent case of the People of

ASTOUNDING SCIENCE FICTION

Sovereign New York against Clarissa Jones."

Joyce could now look at the Accused. She was obviously in poor control of herself, gripping the railing before her with tight hands. Then he turned toward Pedersen.

"Justice Pedersen, what has been the progress of this case?"

"Mr. Justice, the complaint of John Doe has been withdrawn in cognizance of the superior claim of the People."

That was ritual, too. Once the attention of Justice had been drawn to the crime, the original complainant withdrew. Otherwise, the name of the complaining family member would have had to be revealed in open court.

Joyce turned back toward Blanding.

"Justice Blanding will proceed with the statement of the People's case."

Blanding paused for another breath. "We, the People of Sovereign New York, accuse Clarissa Jones of attempting to usurp a place not her own; of deliberately and maliciously using the wiles of her sex to claim recognition from a member of a family, said family member being of minor age and hereinafter designated as "John Doe." We further accuse Clarissa Jones, People's woman, of fomenting anarchy—"

The indictment continued. Joyce watched the Accused's face, noting that despite her emotional strain, she at least retained sufficient propriety not to interrupt with useless exclaima-

tions or gestures. The girl had some steel in her, somewhere. He was pleased at her restraint; interruptions destroyed the rhythm of Trial. She'd have her chance to appeal.

He turned to Pedersen with an inquiring lift of his eyebrows. Pedersen moved closer, keeping his mouth carefully out of the pickup area.

"The girl was young Normandy's mistress. He's got a summer lodge on the river, here," he whispered.

"Joshua Normandy's boy?" Joyce asked in some surprise.

"That's right." Pedersen grimaced. "He might have been more astute, and investigated her a little. She's got a number of relatives in the local craft guilds and whatnot."

Joyce frowned. "Illegitimate relationships don't mean anything."

Pedersen shrugged the shoulder away from the crowd. "Legally, no. But in practice the People have taken to recognizing these things among themselves. I understand their couples refer to each other as husband and wife when among groups of their own kind. I know that's of no weight in court," he went on hastily, "but the girl's apparently an aristocrat among them. It could be natural for her to assume certain privileges. Normandy's specific complaint was that she came up to him on a public street and addressed him by his first name. Well, there she was going a little too far."

Pedersen hooked his mouth into a knowing smile.

"Yes," Joyce answered sharply, his cheeks flattening with rage, as he

looked down at the Accused. "She was."

The youngsters didn't yet understand. They could smile at it. Joyce couldn't. The fact that this was just a thoughtless girl in love made no difference. What had to be judged here was the legal situation, not the human emotions involved.

Centuries ago, The Messire had established this society, speaking through His prophets, and it was that society which Joyce defended here, just as hundreds of Justices defended it every day throughout the land.

There were those worthy of marriage, and those who were not. Those with the mental capacity to rule, administer, judge, and choose the sick to be healed, and those without it. The notion had long ago been exploded that all human beings were equal.

The blunt facts of life were that talent and mental capacity were hereditary. Some human beings were better equipped than others to judge what was best for the human race as a whole, but, with unrestricted marriage, these superior qualities were in grave danger of dilution.

To have attempted to breed the ordinary people out of existence would have been impossible. The sea is not dried up with blotting paper. But the building of dikes *was* possible.

Out of the rubble and flame of the Twenty-first Century, The Messire had handed down the answer, and

the Law. The Law was the dike that penned the sea of ordinary people away from the wellsprings of the families.

Through His prophets, The Messire had ordained his First Families, and they, in turn, had chosen others. To all of these were given the sacrament of marriage and the heritage of name and property for their children. For centuries, the families had been preserved, their members choosing wives and husbands only out of their own kind.

It was unnecessary to enforce childlessness on the remaining people. Neither superior intelligence nor talent were required for the world's routine work.

Nor had "enforcement," as such, of The Messire's Law been required for many years, now. It was not that the people were impious or heretical. Rather it was that, being human, they were prone to error. In their untutored minds, the purpose and meaning of the Law sometimes became unclear.

Despite that simple piety, if young Normandy had been even more of a fool, and let the incident pass, some members of the people might mistakenly have felt such behavior was permissible. The precedent would have been established. If, after that, some other error had been allowed to go uncorrected, yet another step away from the Law might be taken. And after that, another—

Anarchy. And the widening erosion in the dike.

Joyce scowled down at the Accused. He only wished it hadn't been a girl.

Blanding reached the end of his indictment and paused, with a gesture to Joyce.

Joyce looked down at the Accused again, partly because he wished to study her again and partly because it lent weight to his opinion.

The girl's trembling confirmed his previous tentative decision. There was no purpose in dragging this on. The quickest conclusion was the best.

"Thank you, Justice," he said to Blanding. He addressed the Accused.

"Young woman, we have heard your indictment. Justice Blanding will now repeat the etiquette of Trial, in order that there may be no doubt in your mind of your rights."

"The Messire is your judge," Blanding told her gravely. "The verdict we deliver here is not conclusive. If you wish to appeal, make your appeal to Him."

There was a stir and rustle in the crowd, as there always was. Joyce saw a number of people touch the images at their throats.

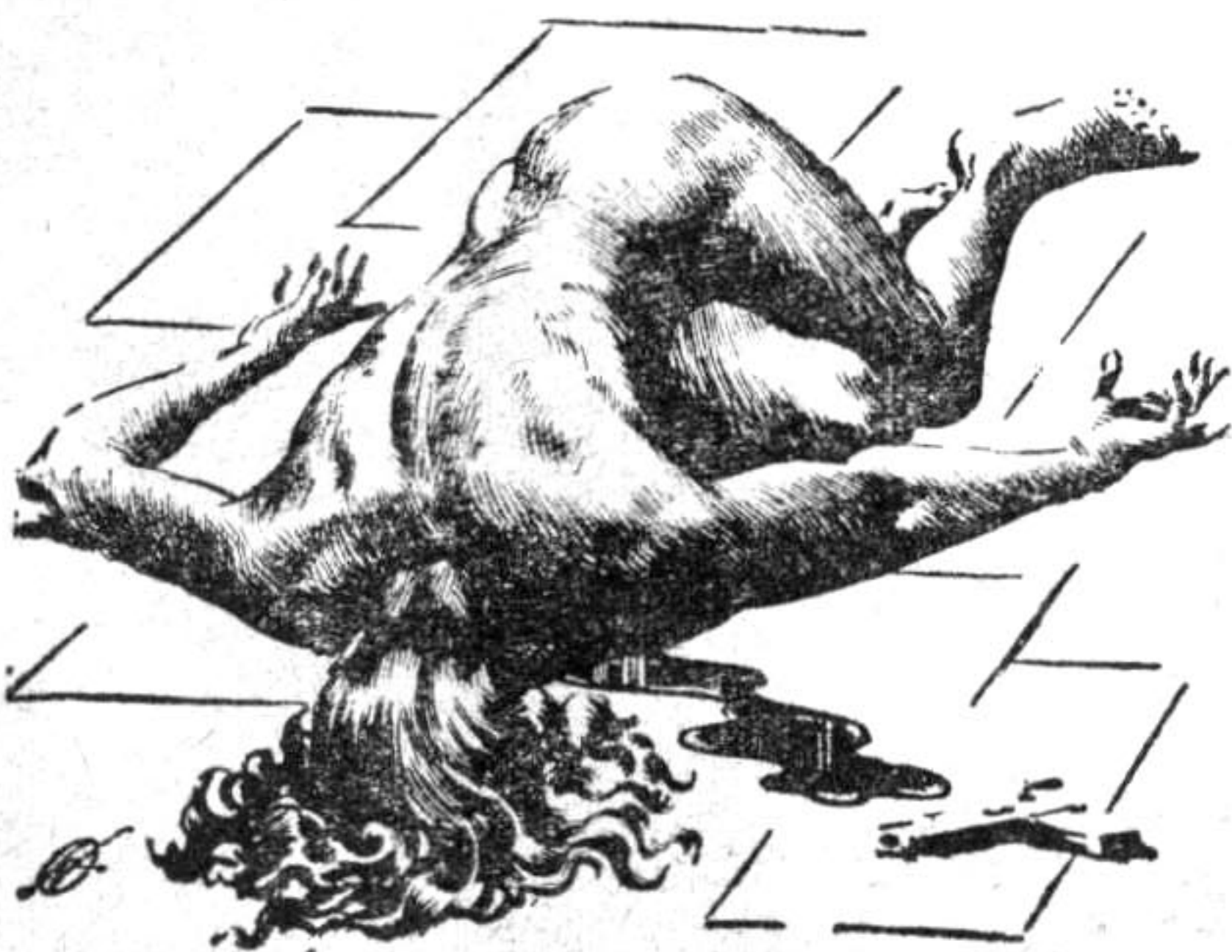

THE EXECUTIONER



"We shall deliberate on this verdict, each separately determining the degree of your guilt. When we have reached a verdict, our separate opinions shall determine the degree of mundane appeal granted you."

Joyce threw a quick glance at the girl. She was looking up at Blanding with her hands on the rail of her box, her arms stiffly extended.

"If your case has been misrepresented to this Court, The Messire will intervene in your behalf. If you are innocent, you have nothing to fear."

Having completed the recital, he stopped and looked out over the heads of the crowd.

Joyce stepped back, and saw that Kallimer and Pedersen were looking down at his hands, hidden from the crowd. He signaled for a verdict of "Completely Guilty." Giving the girl a weapon to defend herself would be ridiculous. If she succeeded in firing

at all, she was sure to miss him and injure someone in the crowd. It was best to get this case out of the way quickly and efficiently. The thing had to be squashed right here.

To his surprise, he saw Kallimer signal back "reconsider."

Joyce looked at the Associate. He might have expected something of the sort from Blanding, but a man of Kallimer's intelligence should have arrived at the proper conclusion.

Perhaps the Bar Association had been very wise to give him this trial, instead of letting some lesser Justice handle it. He'd had his doubts, but this wiped them out.

Without looking at Kallimer, but letting him plainly see the angry swell of the set jaw muscle that tightened his cheek, Joyce signaled "imperative!"

Kallimer sighed inaudibly, and his "acquiesce" was limp-fingered, as though he were trying to convey resignation, as well.

Joyce faced front, still furious, but with his voice under control.

"Justice Blanding, have you reached a verdict?" He moved his left shoulder slightly.

Blanding, from his position on the rostrum, turned and saw the signal.

"I find the Accused completely guilty, Mr. Justice," he said.

Joyce turned to Pedersen in the absolute silence that always fell over a plaza during the rendering of the verdict.

"Completely guilty, Mr. Justice."

Joyce turned to Kallimer.

The man's lips twitched in a faint,

sardonic smile. "Completely guilty, Mr. Justice."

Joyce looked down at the Accused. "I also find you completely guilty as charged," he said. "You will not be allowed a weapon with which to make mundane appeal. Your only recourse is to The Messire's mercy. I pray that our verdict is correct."

He stepped back to a new outburst of applause from the family boxes, satisfied that he had done his best. So far, it was a good trial. Even Kallimer's rebelliousness had been evident only here on the bench. The majesty and unanimity of justice had been preserved as far as the crowd could tell.

He turned and walked slowly down the platform steps, through the deep hush that locked the plaza.

It *had* been a good trial. The Bar Association would detail it and its significance in the Closed Archives, and, generations from now, the older Justices would be reading about it, seeing how his action today had choked off the incipient attack on this culture and this civilization.

But that was not uppermost in Joyce's mind. What men a hundred years from now would say could not have much personal significance to him. What made his pulse beat more and more strongly as he descended the steps, turned the corner of the bench, and walked out into the plaza, was the knowledge that his contemporaries—the other Justices of the Bar Association—the men who had also come to the top, and who under-



stood what the burden was—would know he had not failed the ideal.

He stopped just short of the Ground of Trial and gestured to the attendants around the Accused. They removed the Accused's clothing to guard against armor or concealed weapons, and stepped aside.

Joyce took the final stride that placed him on the Justice's Square, where other amplifiers once more took up his voice.

"The Accused will come forward to make her appeal."

The girl stumbled a bit coming out of the box, and he heard a slight sound of disappointment from the family boxes. It was not a good Entrance. But that could be forgotten.

He reached down, and the gun slipped out of its holster in one smooth sweep of his arm that was pure line of motion as he simultaneously half-turned, his vest standing out in a perfect straight-up-and-down cylindrical fall from his neck to its hem. He came up slightly on his toes, and there was a scattering of "bravo!" from the family boxes as well as the more reserved "excellent" which was really all a lame man deserved for his draw, no matter how perfect his arm motion.

The Accused was standing, pale of face, in the Square of Appeal.

Holding his draw, Joyce waited to speak the ultimate sentence.

He was growing old. The number of trials remaining to him was low. Some day soon, on a verdict of "probably guilty," perhaps, when the Accused had a fully loaded weapon,

The Messire would reverse the verdict.

Not because of his physical slowness. The lameness and hitch in the draw would be merely symptomatic of his advancing slowness of mind. He would not have interpreted the case correctly.

He knew that, expected it, and felt only acceptance for it. A Justice who rendered an incorrect verdict deserved the penalty just as much as a guilty member of the people.

Meanwhile, this was the upheld ideal.

"You have been adjudged completely guilty as charged," he said, listening to the old words roll out over the plaza. "You have not been granted pardon by this Court. Make your appeal to The Messire."

The Accused looked at him wide-eyed out of her pallor. There was no certainty she was praying, but Joyce presumed she was.

Justice rested in The Messire. He knew the guilty and the innocent; punished the one and protected the other. Joyce was only His instrument, and Trial was only the opportunity for His judgment to become apparent. Men could judge each other, and pass sentence. But men could be wise or foolish in their decisions. That was the fallible nature of Man.

Here was where the test came; here where the Accused prayed to The Messire for the ultimate, infallible judgment. This was Trial.

His finger tightened on the trigger while his arm came slowly down and forward. This, too, was where Joyce

prayed to the Ultimate Judge, asking whether he had done wisely, whether he had once more done well. Each trial was his Trial, too. This was his contact with The Messire. This was Truth.

Something whirled out of the silent crowd of people and landed at the girl's feet. It was a gun, and the girl scrambled for it.

As soon as she picked it up, Joyce knew he'd lost his advantage. His reflexes were too slow, and he'd lost two decisive seconds by stopping, paralyzed, and staring at it.

He shook his head to clear away the momentary shock. He gave up paying attention to the confused noise and blind milling of the crowd. He narrowed his concentration down to the girl and her gun. As far as he could permit himself to be concerned, he and she were alone in a private universe, each trying to overcome panic long enough to act.

He'd lost his aim, and his arm had dropped below the line of fire. He brought it up, deliberately slowing his impulse to fling it into position. If he missed, the odds would be all against a second shot.

It was a better aim than the conventional method, in any case. It permitted no elaboration; it had no grace or beauty, but it *was* a steadier method of aiming.

Her shot struck his forearm, and his hand slapped up into the air from the shock. His fingers almost lost their grip on the butt, and he clenched them convulsively.

The girl was tugging at her weapon, doing something with the butt-plate.

His gun discharged into the air, and his arm shook with fresh pain from the recoil.

He could see the Accused was as wrought up as he was. He clutched his forearm with his left hand and steadied down. Before she could fire again, his gun burst into life, throwing her backward and down to the ground. She was obviously dead.

He took a deep, shuddering breath. The gun started to fall out of his weak fingers, but he caught it with his left hand and dropped it into its holster.

The world around him slowly filtered back into his senses. He became aware of angry shouts in the crowd of people, and of attendants struggling to hold them in check. There was a knot of people clustered around a family box, but before he could investigate that, he felt Kallimer put an arm around his waist and hold him up. He hadn't even realized he was swaying.

"We can't worry about the crowd," Kallimer said in a peculiar voice. It was urgent, but he sounded calm under it. There was no hysteria in him, and Joyce noted that to his credit.

"Did you see who threw the gun?" Joyce demanded.

Kallimer shook his head. "No. Doesn't matter. We've got to get back to New York."

Joyce looked up at the bench. Blanding wasn't in sight, but Peder-

ASTOUNDING SCIENCE FICTION

sen was hanging by his hands, dangling down over its face, and dropping to the plaza. He bent, picked up the brief case he'd thrown down ahead of him, ripped it open, and pulled out his gun.

That was idiotic. What did he think he was doing?

"Joyce!" Kallimer was pulling at him.

"All right!" Joyce snapped in annoyance. He began to run toward Pedersen before the fool could disgrace himself. As he ran, he realized Kallimer was right. The three of them had to get back to New York as quickly as possible. The Bar Association had to know.

Pedersen sat far back in his corner of the train compartment, his eyes closed and his head against the paneling as though he was listening to the sound of the trolley running along the overhead cable. The Messire only knew what he was really listening to. His face was pale.

Joyce turned stiffly toward Kallimer, hampered by the sling and cast on his arm. The Associate was staring out the window, and neither he nor Pedersen had said a word since they'd boarded the train, fifteen minutes ago. At that time, there had still been noise coming from the plaza.

There'd been a twenty-minute wait for the train. That meant more than three-quarters of an hour had passed since the start of it all, and Joyce still did not understand exactly what had happened. He had only disconnected impressions of the entire inci-

dent, and, for the life of him, he could find no basic significance behind it, although he knew there had to be one.

"Kallimer."

The Associate turned away from the window. "What?"

Joyce gestured, conscious of his sudden inability to find the proper phrasing.

"You want to know what touched it off. Is that it?"

Joyce nodded, relieved at not having to say it after all.

Kallimer shook his head. "I don't know, exactly. Somebody in the crowd felt strongly enough to throw her the gun. One of her relatives, I suppose."

"But—" Joyce gestured inarticulately. "It . . . it was a *legal* execution! Who would interfere with justice? Who'd take the risk of eternal damnation by interfering with The Messire's obvious will?"

Pedersen, in his corner, made a very peculiar sound. Kallimer shot him a cryptic glare. He turned back to Joyce and seemed to be searching for words.

"Joyce," he said finally, "how do you imagine The Messire would reverse a verdict of 'Completely Guilty?'"

Joyce frowned. "Well . . . I don't know. My gun might jam. Or I might fire and unaccountably miss."

"You don't know for certain, because it's never happened. Am I correct?"

"Substantially."

"Now. How many reversals have

there been on verdicts of 'Apparently Guilty?' When the Accused was given a gun with one cartridge in the chamber."

"A few."

"But it's never happened to any Justice you know, has it?"

Joyce shook his head. "No, but there are recorded cases. A few, as I said."

"Very well. What about 'Possibly Guilty?' Many reversals on those verdicts?"

"An appreciable number."

"Almost had a few of those yourself, didn't you?"

"A few."

"Very well." Kallimer held up his hand, bending one finger for each point. "Now—first we have the case in which the Accused is weaponless. No reversals. Next we have the case in which the Accused has one shot to fire. A few reversals. And finally we have the case in which the Accused has as much of a weapon as the Presiding Justice. An appreciable number of reversals.

"Does it not seem to you, Justice Joyce, that this series of statistics might well occur without the intervention of any Divine Will whatsoever?"

Joyce stared at him, but Kallimer gave him no chance to reply.

"Furthermore, Joyce; do the people have the right to bear arms? That is to say, can you imagine an Accused who was acquainted with the firing and aiming of an automatic

pistol? The answer—you asked, now hear me out—the answer is No.

"More. Have you ever heard of The Messire reversing a verdict of 'Not Guilty?'"

Joyce bridled. "There aren't two of those a year!"

Kallimer's mouth hooked. "I know. But they *do* exist. Explain this, then; how do you reconcile Divine Will with the curious fact that verdicts of 'Not Guilty' and 'Completely Guilty' are *never* reversed, and never have been reversed, though Messire knows we came close this afternoon? Are you claiming that in those cases, every Justice who ever lived was right every time? Are you attempting to claim, for mortal men, the infallibility which is The Messire's particular province?"

Kallimer's face was tense with emotion, and Joyce received a distinct impression that the Associate was speaking with excessive violence, actually his voice was still under control.

"Mr. Joyce, if you can't see the point I'm driving at, I am sorry. But, rest assured, somebody in that crowd of people finally realized it, after all these years. Somebody wasn't afraid of The Messire." Kallimer turned his head sharply and looked out the window at the Hudson, running silver far below as the train swung over to the east shore. "I'm not sure Pedersen wasn't right in drawing his gun. And, Mr. Joyce, if what I've said hasn't shaken you, it certainly should have."

Kallimer took a deep breath and seemed to calm down a little.

ASTOUNDING SCIENCE FICTION

"Mr. Joyce," he said softly, "I believe there's something you haven't thought of. I imagine it'll make you unhappy when I tell you.

"Talking in your terms, now—you don't have to give an inch, Mr. Joyce; in fact, you have to hang on to your beliefs with absolute rigidity to appreciate the full impact—looking at it from your point of view: You can't imagine how The Messire would go about reversing an unjust verdict of 'Completely Guilty.' But The Messire is omniscient and omnipotent. His ways are complex and unknowable. Am I correct? Well, then, how do you know that what happened today wasn't a hint of how He'd manage it?"

The blood drained out of Joyce's face.

Late that night, Emily looked at him in surprise when she answered her door.

"Sam! But you never—" She stopped. "Come in, Sam. You surprised me."

Joyce kissed her cheek and strode nervously into her apartment. He knew what had startled her. He never called on nights following trials; in the fifteen years they'd been together, she would naturally have noticed that. He considered the problem while on his way over, and the only thing to do, he'd decided, was to act as though nothing unusual were taking place. He reasoned that a woman, being a woman, would shrug her shoulders over it after the first few minutes. Probably, after a short time,

she'd even begin to doubt her memory.

"Sam, what's the matter with your arm?"

He spun around and saw her still standing by the door, wearing a dressing gown, with her hair in curlers.

"Trial," he bit off shortly. He paced across the room, took a pear out of a bowl, and bit into it. "I'm hungry," he said with false vigor.

She seemed to collect herself. "Of course, Sam. I'll put something on the stove. It won't be more than a few moments. Excuse me." She went into the kitchen, leaving him standing alone in the semidarkness surrounding the one light she'd switched on near the door. Impatiently, he snapped the switches of the other lamps in the room and stood in the middle of it, chewing the pear and bouncing it in his palm between bites.

He heard Emily put a pan on a burner. He moved abruptly and strode into the kitchen, stopping just inside the door and dropping the pear down the disposal chute.

"Finished it," he said, explaining his presence. He looked around. "Anything I can do?"

Emily looked up at him, a look of amused disbelief on her face, "Sam, what's gotten into you?"

Joyce scowled. "Anything wrong with coming up to see my girl?"

Saying it made the scowl disappear. He looked down at Emily, who was bent over the stove again. Fifteen years had touched her hair, and put little lines on her forehead and the

corners of her mouth. They added a good bit to her lips and waist. But there was an earthly, commonsense comfort in her. He could put his key in the door at any time of night, and she'd hear the sound and be there to meet him.

He reached down and pulled her up. His arm twinged a bit, but that was unimportant at the moment. He folded his arms around her and cupped the back of her head in one palm. The warmth and security of her made his clutch tighter than he'd intended at the start. Suddenly he found himself wishing he'd never have to go back to his own ascetic flat.

Emily smiled faintly and kissed his chin. "Sam, what *did* happen? I heard the trial results over the radio this afternoon, and all they announced for Nyack was a successful conclusion to a verdict of 'Completely Guilty.' Was there some trouble they didn't want to talk about?"

His mood burst, and he dropped his arms.

"What kind of trouble?" he asked sharply.

Her eyes opened, and she looked at him in fresh surprise. "I didn't mean anything by it, Sam. Just ordinary trouble . . . you know, a lucky shot by the Accused—" She looked at the light cast on his arm. "But that couldn't be it, with an unarmed Accused—"

Joyce took an angry breath. "I thought we had that clear between us," he said in a voice he realized was too angry. "From the very be-

ginning, I've made it plain that your province is yours and my province is mine. If I don't tell you about it, you can assume I don't feel you should know."

Emily stepped back and quickly bent over the stove again. "All right, Sam," she said in a low voice. "I'm sorry." She lifted the lid of a pan. "Supper'll be ready in a minute. It'll be pretty busy in here when all these pots come to a boil at the same time."

"I'll be waiting in the living room." Joyce turned and walked out.

He paced back and forth over the rug, his lips in a tight line, conscious now of the pain in his arm.

One more scar. One more objection from The Messire. All safe in the end, but one more objection, nevertheless, and what did it mean?

And the Bar Association.

"A hearing!" he muttered. "A full hearing tomorrow!" As though his report hadn't been adequate. He'd told them what happened. It should have been enough. But Kallimer, with his allegations that there was more to the incident—

Well, all right. Tomorrow he'd see about Kallimer.

Emily came into the living room. "Supper's ready, Sam." Her voice and expression were careful to be normal. She didn't want to provoke him again.

She was hurt, and he didn't like to see her that way. He laughed suddenly and put his arm around her shoulders, squeezing. "Well, let's eat, eh, girl?"

"Of course, Sam."

He frowned slightly, dissatisfied. But there was no point in trying to patch it up and only making it worse. He kept still as they went into the dining room.

They ate silently. Or rather, to be honest with himself, Joyce had to admit that he ate and Emily toyed with a small portion, keeping him company out of politeness.

The act of sitting still for twenty minutes quieted his nerves a bit. And he appreciated Emily's courtesy. As he pushed his coffee cup away, he looked up at her and smiled.

"That was very good. Thank you, Emily."

She smiled faintly. "Thank you, Sam. I'm glad you liked it. I'm afraid it wasn't much. I hadn't planned—" She broke off.

So, she *had* continued to wonder about his calling tonight. He smiled ruefully. And now she thought she'd offended him again. He'd been pretty grumpy tonight.

He reached out and took her hand. "That's all right, Emily."

After she'd washed the dishes, she came in and sat down beside him on the couch, where he was slumped with his feet on a hassock. His ankles and calves were aching. It was all right as long as he kept moving, but once he sat down the ache always began. He smiled at her wanly.

Smiling back, she bent wordlessly and began to massage his calves, working the muscles with her fingers.

"Emily—"

"Yes, Sam?"

"If . . . Nothing, Emily. There's not much point in talking about it." He found himself caught between the desire to speak to someone and the urgent sense that this afternoon was best forgotten. He stared down past his feet without looking at anything. Perhaps there was some way to maneuver her into telling him what he wanted to know, without his having to tell her about it.

Why was he reluctant to talk about this afternoon? He didn't know, exactly; but he couldn't bring himself to do it, no more than he could have discussed some character defect he might have accidentally observed in a lady or gentleman.

"What else did they say over the radio?" he asked without any special intonation. "About Nyack."

"Nothing, Sam, except for the bare results."

He grunted in disappointment.

Perhaps there was some better angle of approach. "Emily, suppose . . . suppose you knew of a case involving a people's girl and a family man. Suppose the girl had come up to the man on a public street and addressed him by his first name.

He stopped uncomfortably.

"Yes, Sam?"

"Uh . . . well, what would you think?"

Emily's hands became still for a moment, then began working on his calves again.

"What would I think?" she asked in a low voice, looking down at the floor. "I'd think she was very foolish."



He grimaced. That wasn't what he wanted. But did he know what he wanted from her? What *was* the answer he was looking for? He tried again.

"Yes, of course. But, aside from that, what else?"

He saw Emily bite her lip. "I'm afraid I don't understand what you mean, Sam."

A tinge of his earlier anger put a bite in his voice. "You're not that unintelligent, Emily."

She took a deep breath and looked at him. "Sam, something drastic went wrong today, didn't it? Something very bad. You were terribly upset when you came in—"

"Upset? I don't think so," he interrupted quickly.

"Sam, I've been your mistress for fifteen years."

He knew his face was betraying him. In her flashes of shrewdness, she always did this to him. She'd put her finger exactly on the vulnerable truth, disarming his ability to cover up.

He sighed and spread his hands in a gesture of resignation. "All right, Emily. Yes, I am upset." The irritation welled up again. "That's why I want some help from you, instead of this evasiveness."

She straightened up, taking her hands off his aching legs, and half-turned on the couch, so that she was looking directly into his eyes. She held his gaze without hesitation.

"Maybe you're asking too much of me. Perhaps not. This *is* important, isn't it? I've never seen you quite as troubled as this."

**ASTOUNDING SCIENCE FICTION**



She was tense, he realized. Tense, and apprehensive. But he saw, as well, that she had decided to go ahead, despite whatever her private doubts might be.

"Yes," he admitted, "it's important."

"Very well. You want to know what I think about that girl? Suppose you tell me what you think, first. Do you believe she did it out of spite, or malice, or impulse?"

He shook his head. "Of course not! She was in love with him, and forgot herself."

Emily's eyes welled up with a sudden trace of tears. Joyce stared at her, dumfounded, for the few seconds before she wiped one hand across her eyes in annoyance.

"Well?" she asked in a low voice.

"I'm afraid it's my turn not to understand," he said after a moment. He frowned. What was she driving at?

"What distinguishes me from that girl, Sam? A few years? What do you expect me to think?"

"It's not the same thing at all, Emily!" he shot back in honest anger. "Why . . . why you're a mature woman. We're—"

He couldn't really point out the difference, but he knew it was there. She'd never said or done anything—

"Emily, you know very well you'd never do what that girl did!"

"Only because I'm more conscious of the rules," she answered in a low voice. "What real difference is there between her and myself? It is that it's you and I, rather than two other peo-

ple; rather than any one of the scores of similar couples we know? What distinguishes us in your eyes? The fact that we're not a case for you to try?"

"Emily, this is ridiculous!"

She shook her head slowly. "That girl broke the law. I haven't. But I haven't only because I realized, from the very start, just what kind of tight-rope I'd be walking for the rest of our lives. I couldn't leave you and go back to the people, now; I've grown too used to living as I do. But I'll always be no more than I was born to.

"Suppose I were a People's man—a mechanic, or perhaps even an engineer if I'd bound myself to some family. I'd know that all my skill and training wouldn't be of any use if I were accused of some crime in a court of law. I'd know that addressing my patron in public by his first name would be a crime—a different kind of crime than if I were my patron's mistress, certainly, but a crime, nevertheless. Let's assume that, as my patron's engineer, I overrode his will on the specifications for whatever product my patron manufactured. Or that I attempted to redesign a product or develop a new one without first getting his approval and suggestions; that would be legally analogous to what the girl did, wouldn't it?"

"Yes, and properly so," Joyce retorted.

Emily looked at him and nodded slowly. She went on:

"If I were that engineer, and I had any common sense, I'd be constantly aware of the difference between my-

self and my patron. I would remind myself, every day, that my patron was born to a family, and that my patron would, in turn, be permitted the sacrament of marriage when he desired it with a lady. I would understand that engineers were members of the people, and that my patron was a member of one of the First Families, or a Legislator, or a Justice. Realizing all this, I would always be careful never to encroach on the difference between us, accepting my fate in having been born to the people, and his having been born to a family."

Joyce frowned. "That sounds a little bit as though you considered birth a blind accident."

Emily looked at him silently. She took a deep breath. "Being an intelligent person, I, as that engineer, would attribute my station at birth to the direction of The Messire. You'll hear no heresies from me, Sam." She reached out and took his hand.

"That's why I'll say, again, that the girl in Nyack was foolish. That *was* the case in Nyack, wasn't it? She did what none of us, in our right minds, would consider doing. Certainly, she did what I'd never do, but then, I'm older than she. I was older when I came to you, or I at least assume so, since you called her a girl."

Suddenly, she bit her lip. "Young people in love are not necessarily in their right minds, just as people enraged are not acting logically. Who's to say what their punishment should be?"

"There is Someone," Joyce answered firmly.

Emily nodded, looking at him, her expression abstracted. Suddenly she said:

"Sam, have you ever really looked at yourself in a mirror? Not to see whether you'd shaved properly, or whether your wig was crooked on the morning before a trial, but just to look at yourself."

He couldn't understand this new tack.

"Do you know you have a very young face, Sam? Under that black beard-shadow, with the scowl gone, you've got the face of a troubled adolescent. You've taught yourself dignity, and put flesh on your body, but you're still a young boy, searching for the key that will wind the world up to run accurately forever. Perhaps you believe you've found it. You believe in what you're doing. You believe that justice is the most important thing in the world. What you do, you do as a crusade. There's no wanton malice or cruelty in you. I don't believe I've ever known you to do anything purely for yourself.

"I love you for it, Sam. But, except sometimes with me, you've submerged yourself in your ideal, until you've learned to ignore Sam Joyce entirely. You're Mister Justice Joyce all the time."

She closed her hand on his. "Something happened this afternoon, and I suspect it was drastic. You've come to me after facing an unarmed Accused—a girl, young and unskilled

—but there's a cast on your arm, and what must be a bullet hole under it. I don't know what happened. I do know there's a news blackout on Nyack.

"Sam, if the system's been finally challenged, then you're in terrible danger. Other men aren't like you. Other men—people's men and family men—act in rage, or fear, or love. If they tear down your world and your ideal—"

*"Tear down—!"*

" . . . If they tear down what you have given your life to, there will be nothing left of you. If the system goes, it takes Justice Joyce's lifeblood with it, and only I know where the little fragment of Sam Joyce lives. It won't be enough."

"Emily, you're exaggerating beyond all reason!"

Emily clutched his hand. He saw, to his complete amazement, that she'd shut her eyes against the tears, but that streaks of silent moisture were trickling down her cheeks.

"You've come to me for help, but I'm part of the world, too, and I have to live the way it lets me. After all these years, you want to know whether you've been right, and I'm supposed to tell you.

"I told you I thought the girl was foolish. Sam, I love you, but I don't dare give you your answer. I told you: you won't hear any heretical statements from me."

The night had slowly edged into dawn. Joyce stared at it through the window beside the bed. He had no

way of knowing whether Emily had ever gone to sleep or not. She was lying motionless, just as she had been all night.

Joyce's eyes were burning, and the short stubble of his graying natural hair was thick with perspiration. The night had been sleepless for him.

His arm was much better this morning, but he still remembered the shock of the bullet.

If you believed, as you must believe, that The Messire saw every human deed, knew every human thought, and caused every human event, then what had He meant in Nyack?

If the sentence was correct, why did The Messire permit her that one shot? Why hadn't whoever threw the gun been stopped before he could do it? If the sentence was unjust, why hadn't she killed him?

Was it that The Messire approved of him, but not of the basis of his judgment? But his basis was the Law, and The Messire had handed down the Law!

Was it, as Kallimer had said, that The Messire was not as Joyce conceived of him?

What did Emily think?

He reminded himself that what Emily thought was irrelevant, as he had hastily reminded himself many times during the past night. Her opinion did not govern the truth or falsehood of justice. Justice was an absolute; it was either right, no matter what the opinions of Mankind, or it was worthless.

Was it, as Kallimer had said vi-

ciously, that The Messire was trying to make him understand something?

What?

What had He meant in Nyack?

Joyce lay on the bed, exhausted. He knew he was thinking wildly. He'd gone over and over this ground, trying to find the proper logic, and accomplishing nothing. He was in no condition to reason correctly. He only hoped he could act wisely at the hearing this afternoon.

He slipped cautiously out of bed, hesitating at every rustle of the sheets. Once out, he dressed hastily, and left the apartment as quietly as he could. He didn't want Emily to wake up and see what condition he was in.

He walked into the hearing room with measured steps, hoping no one would notice his unsettled state of mind. When the Chief Justice showed agitation, what could anyone expect of the lesser Justices?

This, too, was part of the task, and the young, ambitious Associate Justice of Utica hadn't had the faintest inkling of it, just as, throughout his dedicated advancement through the ranks of his profession, he could not have dreamed how difficult it would some day be to walk steadily through a door when sleepless legs and aching ankles dragged at every step.

He saw the tension rampant in every Member. No one was sitting down quietly, waiting for the hearing to begin. Knots of men stood everywhere, talking sharply, and there was a continual movement from one group to another.

Joyce scowled in annoyance and nodded shortly as most of the faces in the room were turned toward him. He looked around for Joshua Normandy, but the Bar Association's Chairman had not yet come in. He saw Kallimer, standing to one side, wearing his frown and talking alone to a white-faced Pedersen.

Joyce went over to them. He hadn't decided yet what to do with Kallimer. The man was arrogant. He seemed to derive genuine pleasure from talking in terms Joyce was unable to understand. But the man was intelligent, and ambitious. His ambition would lead him to defend the same principles that Joyce defended, and his intelligence would make him a superlative Chief Justice, once Joyce was gone.

For the sake of that, Joyce was willing to let yesterday's questionable behavior go. Perhaps, after all, Kallimer had been right in asking for a reconsideration of the verdict.

Once again, Joyce was painfully conscious of his inability to arrive at any firm opinion on yesterday's events. He stopped in front of Kallimer and Pedersen with a shake of his head, and only then realized how peculiar the gesture must look to them.

"Good afternoon, Justice," Kallimer said dryly.

Joyce searched his face for some indication of his state of mind, but there was nothing beyond the omnipresent frown.

"Good afternoon, Justices," he said finally. "Or have the election results

been confirmed, Legislator?" he asked Pedersen.

Pedersen's face was strained. "Yes, sir. The results were confirmed. But I resigned."

Joyce's eyebrows shot up. Recovering, he tried to smile pleasantly. "Then you're returning to the Bar?"

Pedersen shook his head. "No . . . uh—" he husked in a dry voice, "I'm here simply as a witness to . . . uh . . . yesterday." He was deathly pale.

Kallimer smiled coldly. "Mr. Pedersen has decided to retire from public life, Justice Joyce. He now considers that his first attempt to dissociate himself from the Bar was inadequate."

Joyce looked from Kallimer back to Pedersen. The younger man, he suddenly realized, was terrified.

"Blanding's dead, you know," Kallimer said without inflection. "A paving block was thrown at his head yesterday afternoon. It's uncertain just what the circumstances were, but a member of the Civil Guard brought the word out." Kallimer smiled at Pedersen. "And now our former Associate, his earlier presentiments proven correct, is shortly taking a trip abroad—the Lakes Confederation, I believe?"

"I have distant relations in St. Paul," Pedersen confirmed huskily. "And there is an Ontario branch of the family in Toronto. I plan to be away for some time. A tour."

Kallimer still smiled. "The key word in that statement would be 'distant,' would it not, Mr. Pedersen?"

Pedersen flushed angrily, but Joyce seized on Kallimer's attitude as a reassuring sign. At least, Pedersen's cowardice wasn't general. For the moment, that seemed more important than the news of Blanding's death.

His lack of astonishment made him look at himself in wonder. Was he that much upset, that a Justice's murder failed to shock him? Was he really that far gone in his acceptance of the incredible?

He knew, with a calmly logical part of his mind, that before yesterday he would have considered himself insane to even think of anyone's attacking the Law. Today, he could pass over it. Not lightly, but, nevertheless, pass over it.

"You're sure of your information, Kallimer?" he asked.

Kallimer nodded, looking at him curiously. "The witness is reliable. And he brought out the gun, too. That's an astonishing item in itself. You'll be interested."

Joyce raised his eyebrows politely. "Really?" He saw Joshua Normandy come into the hearing room, and nodded in the Chairman's direction. "The hearing's about to begin. It'll be brought up, of course?"

Kallimer was frankly puzzled by his attitude. Joyce's head was erect, and his shoulders had abruptly straightened out of their unconscious slump.

"Yes, of course."

"Good. Shall we take our places? Good afternoon, Mr. Pedersen. It was a pleasure, having you on my bench." He took Kallimer's arm, and, to-

gether, they strolled up to the long table facing the chairs of the lesser Justices.

Joyce knew what was happening to him, and the calm, judicial part of his mind, at last given something it understood to work with, approved.

He had been in a panic. At noon, yesterday, the foundations of his logic had been destroyed. The integrity of justice and Justices had been attacked, and his belief in the universal acceptance of The Messire's Law had been proved false. He had discovered, in one climactic instant, that there were people willing to deliberately attack the Law.

He had been beyond his depth. He had no precedent for such a crime; no basis on which to judge the situation. Someone else, perhaps, such as Kallimer or Justice Normandy, might have the reach of mind to encompass it. But Joyce knew he was not a brilliant man. He was only an honest man, and he knew what was beyond him. In the instant that he had stopped, staring dumfounded at the gun lying on the plaza stones, with the Accused reaching for it eagerly, he had stopped being capable of evaluating the legal situation and taking steps to rectify it. Panic could warp a man's judgment completely.

That was what The Messire had been trying to make him realize. The world was changing, and the Chief Justice was not equipped to deal with the change.

As an honest man; as a man sincere in his beliefs, he was ready to

give up his responsibilities and let the better suited men take them up.

He nodded to Justice Normandy and the other Bar Association officers. Then he sat down calmly, with Kallimer beside him, and waited to see what the more intelligent men had made of the situation.

Kallimer was holding up the gun brought out of Nyack. Joyce looked at it curiously.

It was late in the afternoon, and a good deal of testimony had already been recorded. Pedersen stated that he was aware of angry movement in the crowd as Joyce made his draw, but that the gun had been thrown by an unidentified man before anything could be done. After the shooting, the man and a surrounding group of other men had been lost in the crowd. The crowd itself had been bewildered at first, and then divided in its reaction. That early in the riot, there had been no signs of unanimous effort.

The Civil Guardsman had testified that, as far as he knew, he was the only survivor of the squad detailed to keep order during the trial. He had seized the gun after the executed Accused dropped it, and run to Guard headquarters for help. It was his impression that the immediate deaths among family members at the trial were the result of spontaneous riot in the crowd, and not of any organized plan of assassination.

Justice Kallimer had commented that this was also his impression. The only traces of intelligent planning, he stated, had shown themselves in the

ASTOUNDING SCIENCE FICTION

cutting of the train cables out of Nyack and the attack on the radio station, where the supervising family man had smashed the transmitter before it could be captured. Note was made of the loyalty of the station engineering staff.

Now, Kallimer said: "Bearing previous testimony in mind, I'd like to call this hearing's attention to the construction and design of this illegal weapon."

Joyce bent closer. There were a number of peculiarities in the gun, and they interested him.

"First," Kallimer went on, "the weapon is obviously handmade. Its frame consists of a solid metal piece—steel, I'm told by a competent engineer—which bears obvious file marks. Moreover, it is of almost primitive design. It has a smoothbore barrel, drilled through from muzzle to breech, and is mortised at the breech to accommodate one hand-inserted cartridge and a spring-loaded hammer. Additional cartridges are stored in the butt, covered by a friction plate. It is fired by thumbing back the hammer and releasing it, after which the fired cartridge case must be removed by hand before it can be reloaded.

"A hasty weapon. A weapon of desperation, thrown together by someone with only a few hours to work in."

Kallimer put the gun down. "A hopelessly inefficient and inadequate weapon. I am informed that the barrel was not even drilled parallel to the frame's long axis, and that the

crude sights were also askew, further complicating the error in aiming. It is remarkable that Mr. Justice Joyce was struck at all, and it is no wonder at all that the Accused was never able to fire a second shot."

Joyce shook his head slightly. It was perfectly obvious how the girl had managed to hit him. But then, Kallimer, with his slightly eccentric viewpoint, would not be likely to take The Messire into account.

Kallimer was speaking again.

"The point, however, isn't relevant here. It is the nature of this weapon which concerns us. Obviously, it was not constructed by anyone particularly skilled in the craft, and its design is hopelessly unimaginative. It is unlikely that any others exist. It follows, then, that the rebellion, if I may call it such for the moment, is largely confined to the Accused's immediate . . . ah . . . relations. No actual large-scale, organized effort exists.

"We have the testimony of Mr. Pedersen and the Guardsman. It seems obvious that the gun-throwers' plans culminated in the delivery of the weapon to the Accused. What followed was a spontaneous demonstration. This, together with some other relevant data already mentioned in testimony, is the basis on which we have formulated our program of rectification."

Kallimer turned toward the center of the table. "Justice Normandy."

Normandy was an aged, gray-headed man whose heavy brows hung low

over his eyes. He rose out of his chair and supported his weight on his hands, leaning out over the table and looking toward the lesser Justices in their seats.

Joyce looked at him curiously.

Normandy had never been Chief Justice. He'd risen to Chief Associate under Kemple, the Chief Justice before the one Joyce had replaced. The oldest son of one of the First Families, Normandy had then retired from active work, becoming first Recorder and then Chairman of the Bar Association. He'd held the position longer than Joyce had been Chief Justice, and he was at least seventy.

Joyce wondered what he and Kallimer had decided to do.

Normandy's voice was harsh with age. He forced each word out of his throat.

"Justice Kallimer has summed up very well. A purely personal rebellion against the Law in Nyack has touched off a spontaneous demonstration. You've noticed the lack of evidence implicating any ringleaders except the Accused's relations. They're nothing but woodworkers. There was some later participation by engineers, because it took training to see the importance of cutting off communications. But that wasn't until this emotional upheaval had a chance to get contagious.

"There's a certain rebellious feeling, yes. But it's hardly born yet. It won't spread unless we let it, and we won't. By tomorrow afternoon, we'll be back to normal.

"Thank you, Justices. This hear-

ing's concluded, and Mr. Joyce, Mr. Kallimer, and I will stay behind for further discussion."

Joyce watched the lesser Justices file out of the hearing room, their manner much less nervous than it had been. Normandy had put some starch back into their spines.

Joyce, too, felt better. He'd been right in expecting Kallimer and Normandy to have a solution. He was leaving the Law in capable hands.

Normandy waited until the room was empty. Then he turned to Kallimer with an expression of disgust.

"Well, they believed it. I'd be happier if a few of them hadn't."

Kallimer shrugged. "There's no telling. If any of them saw through it, they'd be intelligent enough not to show it."

Normandy cocked an eyebrow, pursed his lips, and, after a moment, grinned. "That's a good point."

Joyce looked blankly at both of them. "I gather," he said finally, "that the situation is more serious than was divulged." He felt a slight return of his old disquiet, but nothing near panic.

Normandy and Kallimer turned in their chairs. Both of them looked at him speculatively.

Normandy nodded. "By quite a good bit. It took the engineers a while to realize what was happening, but they took over the rebellion within the first hour. They're directing it now. We had to bomb the radio station and establish a false transmitter on the same wave length. It looks

ASTOUNDING SCIENCE FICTION



very much as though the engineers had a plan ready to use, but not quite this soon. They were caught a little short."

Normandy grimaced. "Not short enough, though. We anticipated a little trouble down there, but we were unprepared for the discovery of anything like that. The Guard can't handle it. I sent in the Army this morning."

Kallimer grunted. "You know," he told Normandy, "I asked Joyce to reconsider his verdict."

Normandy's eyes snapped open. "You did? Why?"

"We didn't need any tests, after all. I could smell the trouble in that crowd. It was that thick. They didn't know it themselves, but they were spoiling for a riot." He shrugged. "Joyce overruled me, of course. It's a good thing, too, or we'd never have found out in time just how deep the trouble had dug."

Normandy stared thoughtfully off into distance, his head barely moving as he nodded to himself. "Yes," he whispered under his breath.

He looked sharply at Joyce. "How much of this shocks you, Justice?"

Joyce was looking at the expression on Kallimer's face. It had become coldly sardonic.

"I—" He broke off and shrugged in reply to Normandy's question. "I don't really know. But I'm sure you're aware of what you're doing." Nevertheless, he was bewildered. He couldn't quite make out what Kallimer had meant.

Normandy looked at him steadily,



his black eyes watchful. "I've always been of two minds about you," he said in a thoughtful voice. "I believe I chose wisely, but there's no certainty, with individuals like you." He grinned in his abrupt way. "But sometimes a calculated risk is justified. Sometimes, only an honest man will do."

Joyce's bewilderment was growing. He understood that Normandy was being much more candid with him than he had ever been before. Vaguely, he was aware that the situation had forced Normandy into it.

But if *Normandy* was being forced into drastic steps, then what did that say about Sam Joyce's ability to do the proper thing in this crisis?

"There's something I believe I should tell you," he said quickly, conscious of a return to his earlier panic. He had to state his position as early in this discussion as possible, before Normandy and Kallimer assumed he could be counted on. "I'm . . . not sure of exactly what you mean about me," he went on as Normandy and Kallimer looked at him curiously. "But there's something you should know."

He stopped to choose his words carefully. He had to convince these men that he wasn't acting on impulse; that he'd thought this out. They deserved an explanation, after having assumed he'd help them. And, too, it was important to him personally. Possibly this was the most important decision of his life.

"I've been Chief Justice for a comparatively long time," he began. He

had; he'd always felt The Messire had a good servant in him, and, up until yesterday, The Messire had seemed to agree.

He looked down at his hands. "I have a good record. I've done my best.

"You know my history. I began years ago, on a minor bench, and I rose step by step. No one has the skill with his gun or is better in the ritual of Trial than I was in my prime." He looked up at Normandy and Kallimer, trying to see whether they understood him. "I feel that I've been a good Justice; that I've served The Messire's Law as He desired it. But I've always known I wasn't the most brilliant man on the bench. I haven't delivered many famous opinions, and I'm no lawyer's lawyer. I've simply"—he gestured indecisively—"been a Justice for a long time." He paused momentarily.

"But this," he went on in a low voice, "is beyond my capabilities." He looked down again. "I know I haven't the capacity to do my duty properly in this situation. I'd like to resign in Justice Kallimer's favor."

There was a long silence. Joyce did not look up, but sat thinking of the foolish things he'd done and thought during the past two days.

He looked up, finally, and saw Normandy's quizzical expression. Kallimer's face was a nonplussed blank.

Normandy tented his fingertips and blew out a breath over them. "I see." He looked cryptically at Kallimer, and

Kallimer seemed to exchange some silent message with him.

Kallimer spoke slowly. "Mr. Joyce, I know you well enough to realize this hasn't been a hasty decision. Would you mind telling me what led you to it?"

Joyce shook his head. "Not at all. I've decided that this is the only possible interpretation of yesterday's events in the plaza. It seems clear to me that The Messire's intent was to have me do what I've just done."

Normandy jerked his head violently, and stared at Joyce. "I'll be damned!" he exploded.

Kallimer's mouth twisted. "This is hardly what I expected to result from our talk yesterday," he murmured. He looked at Joyce with perverse admiration. Then he spoke to Normandy. "Well, Justice, there's your honest man."

Normandy shot Kallimer one sour look before he turned back to Joyce. His voice grated harshly.

"That's all well and good, but you're not resigning. Not now, at least, and never in Kallimer's favor. You've still got one Trial to run, and Kallimer's after my job, not yours."

"Not until after you've retired, Justice," Kallimer interjected, turning his sardonic smile on Normandy. "I've made it clear I have no intention of competing with *you*. Furthermore, I'm your only natural heir in any case." He chuckled for the first time in Joyce's experience. "There aren't many like us born to each generation, are there, Justice?"

Joyce sat numbly, unable to decide

what he thought of Normandy's outburst.

"Justice Normandy—" he said finally.

"What?"

"You say I've still got one Trial—"

"Yes!"

"But, if The Messire has indicated that He no longer considers me competent, the Trial will be prejudiced—"

Normandy thrust himself out of his chair and away from the table. His eyes were blazing, and his hands trembled. "Damn your Messire! He didn't meddle with your last trial, did he?"

"Sir?"

Normandy cursed again and turned away. "Kallimer, talk to this moron! I've had enough." He stalked out of the hearing room, and the door crashed behind him.

Kallimer was looking after him with a faint look of exasperation tingeing the amusement of his mouth.

"He's getting old, Joyce." Kallimer sighed. "Well, I suppose the day will come when I'll have no more patience, either. It's a shaky pedestal he sits on."

Joyce was in a turmoil. He knew his face was pale.

Kallimer turned back to him. "There's been an insertion made in your court calendar," he told him. "Tomorrow, you'll hold a special mass trial for the engineers the Army will be dragging out of Nyack. They'll be indicted as 'mem-

bers of the people.' Their origin won't be specified—no use alarming the nation. Is there? And I suppose there'll be a variety of charges. I'll set them up tonight. But the verdict'll be 'Completely Guilty' in every case. You and I and a couple of other Justices will handle the executions."

Joyce found himself unable to argue with more than the last few statements. Too much was happening.

"A mass trial? Here, in New York, you mean. For the Nyack rebels. But that's illegal!"

Kallimer nodded. "So are improper indictment and prejudged verdict. But so is rebellion.

"This folderol of Normandy's has a rather shrewd point. The rebels will be punished, but the general populace won't know what for. Only the other rebellious organizations scattered throughout the country will realize what's happened. It'll slow down their enthusiasm, giving us time to root them out."

Joyce looked down at the floor to hide the expression on his face. Kallimer seemed not at all concerned with breaking the spirit of the Law. Normandy was even more blunt than that.

It was a frightening step in his logic, but there was only one possible answer. Both of them were acting as though man made the Law, and men administered the final verdict; as though there were no Messire.

He looked up at Kallimer, wondering what his face was showing of the sudden emptiness in his stomach. He felt as though he was looking down at the Associate from a great height,

or up from the bottom of a pit.

"What did Normandy mean about my last trial?" he asked in a low voice.

"First of all, Joyce, bear in mind that The Messire is omniscient. He knows of more crimes than we possibly can. Even if we judge a case incorrectly, it is possible our verdict is nevertheless justified by some other crime of the Accused's."

He looked at Joyce with a flicker of anxiety flashing subtly across his face, leaning even closer, and Joyce's first emptiness became a twinge of disgust and sickness.

"I accept that," Joyce said, the words tasting cottony in his mouth, but wanting to urge Kallimer on.

Kallimer twitched his shoulders. "Perhaps you do," he muttered. Joyce appreciated, with a deep, bitter amusement that never came to the surface, just how much Kallimer must hate Normandy for leaving him with this task to perform.

"In any case," Kallimer went on, "about the girl, yesterday; Normandy's son had heard some things from her. A lot of unrest in Nyack; talk; dissatisfaction; that sort of thing. He told his father.

"It wasn't the only place we'd heard that from, but it was our only real lead. It was decided that a trial, with a particularly controversial member of the people as the Accused, might bring enough of it to the surface for us to gauge its importance."

He stopped and shook his head. "It certainly did. We hadn't the faintest idea it was that strong, or

that close to exploding. Sheer luck we found it out."

Joyce looked steadily at Kallimer, hoping his face was calm. "The girl wasn't guilty."

Kallimer's mouth twitched. "Not of the charge we tried her on, no. Normandy's son accused her on his father's orders. You were sent down to try the case because we could predict you'd give us the verdict we wanted. I went along to observe."

Joyce nodded slowly. "I think I understand, now," he said.

In the middle of the day, just at noon, Samson Joyce stood at the foot of the high steps behind New York City's onyx judges' bench.

"Ready, Justice?" Kallimer asked him.

"Yes," Joyce answered. He replaced the ceremonial gun in its tooled holster.

Kallimer looked at him again and shook his head. "Justice, if we weren't in public, I'd offer you my hand. You hit bottom and you've come up swinging."

Joyce's lower lip tugged upward at the corners. "Thank you, Justice," he said, and prepared to walk up the steps on his aching legs.

Emily had been puzzled, too, as he prepared to leave her this morning.

"Sam, I can't understand you," she'd said worriedly, watching him scowl with pain as he stood up from putting on his boots.

He smiled at her, ignoring the ache in his legs. "Why?"

"You haven't slept in two nights, now. I know something new happened yesterday."

He bent and kissed her, still smiling.

"Sam, what is it?" she asked, the tears beginning to show at the corners of her eyes. "You're too calm. And you won't talk to me."

He shrugged. "Perhaps I'll tell you about it later."

The steps seemed almost inhumanly high today, though he'd walked up them often. He reached the center of the bench gratefully, and leaned against the parapet. Looking down, he saw the Accused standing in their box. They'd been given new clothing, and an attempt had been made to hide their bandages. They were a sullen, dun-colored knot of men and women.

He looked across the plaza at the First Family boxes, crowded with the family men and their ladies, and the lesser family boxes flanking them. There was the usual overflow crowd of people, too, and a doubled force of Civil Guards.

The Accused, the First Families, the lesser families, the people, and even some of the Civil Guards, were all watching him. For all that a number of Justices would go through the full ritual of Trial today, he was the only one who wore the Suit.

When he'd come home to Emily last night, she'd asked him what had happened, looking up at his calm face.

"I went to Chapel after the hear-

ing," he'd told her, and now he seemed to stand there again.

Lowery, one of Manhattan's Associate Justices, began to read the indictments. It was only then that Joyce realized there'd been applause for him and his Associates, and that he'd automatically instructed Lowery to begin.

He listened to the solemn beat of the words in the plaza.

This was Trial. Once again, men stood before The Messire, and, once again, the Justices endeavored to act as proper instruments of His justice.

Thirty years of trials had brought him here, in his Suit. In that time, The Messire had thought well of him.

But Kallimer and Normandy had planted the dirty seed of doubt in his mind, and though he knew them for what they were, still, the doubt was there. If the girl had been innocent, how had he been permitted to execute his unjust sentence upon her?

Kallimer had given him an answer for that, but Kallimer had given him too many answers already. It wasn't until he stood in Chapel, watching the candles flicker, that he understood where the test would lie.

If there was no Messire—the thought bewildered him, but he clung to it for argument's sake—then every particle of his life was false, and the ideal he served was dust.

If there was an Ultimate Judge—and how many noons, in thirty years, had brought him the feeling of communion with his Judge—then Joyce

knew where to make his appeal.

He looked across the plaza at Joshua Normandy's box, and reflected that Normandy could not begin to guess the magnitude of what was undergoing Trial today.

He put his hand inside his vest and closed his fingers around the butt of his Bogen. It was his gun. It had served him as he had served The Messire; efficiently, without question.

Here was where the test came; here where men prayed to The Messire for the ultimate, infallible judgment.

The Messire knew the guilty, and the innocent; punished the one and protected the other. Joyce was only His instrument, and Trial the opportunity for His judgment to become apparent.

He whispered to himself: "I pray my verdict is incorrect, but if it is not, I pray that justice prevail at this trial." He took out the gun. "And if there is no justice, and no Messire, then I, as a man, as Chief Justice, have nevertheless pronounced the verdict and passed sentence."

He turned quickly, and fired in Kallimer's direction. He fired across the plaza at Joshua Normandy. Then he began to fire at random into the First Family boxes, seeing Normandy collapse in his box, hearing Kallimer's body tumble backward off the bench, and knowing, whether he was right or wrong, that whatever happened now, The Messire had not, at least, reversed his verdict.

This was the Truth he'd lived for.

THE END

# INDIRECTION

*The best way to keep a secret is to publish it in a quite unbelievable form—and insist that it is the truth.*

BY EVERETT B. COLE

Illustrated by Freas

Elwar Forell leaned back in his chair, looking about the small dining salon. The usual couples were there, he noticed. Of course, the faces were different from those of last evening, but the poses were similar. And the people were there for the same reasons. They were enjoying the food and drinks, just as many others had enjoyed them before. But like all those others, their greater enjoyment was in the company of one another. Forell glanced at the vacant chair across the table from him and sighed.

It would be nice, he thought, if— But any arrangement involving a permanent companion would be hardly practical under his circumstances. After all, prudence dictated limits.

He picked up his cup and drained it, then leaned back and beckoned the waiter over.

"The reckoning, please," he ordered.

He looked again at the letter on

the table before him, then folded it and put it in his pocket. It was well, he thought. His latest book of fairy tales and fantasy had enjoyed good acceptance. And the check in the letter had been of satisfactory size. He smiled to himself. There were compensations in this job of his. It seemed to be profitable to have a purpose other than the obvious and usual one.

He paid his bill and left the restaurant, to walk slowly along the street, enjoying the mild, spring air.

As he passed a sidewalk café, a man beckoned from one of the tables.

"Oh, Forell," he called. "I was hoping I'd see you this evening." He held up a book.

"Just finished your 'Tales of the Sorcerers,'" he added. "Some of those yarns of yours seem almost real."

Elwar Forell nodded. They should, he thought. Factual material, how-

ever disguised, often shines through its fictional background. And he had an inexhaustible source of material, drawn from many sources. He twisted his face into a gratified smile.

"That's my objective," he said aloud. "I do all in my power to place the reader inside the story."

Charo Andorra nodded. "It's the secret of good fiction, I know," he admitted, "and every storyteller tries to do it. But I seem to see more than that in your stuff. There's an almost believable pattern." He hesitated. "You know, while I'm reading it, I can almost see beings of superior powers walking the earth. And sometimes, I visualize us working with them." He laughed shortly.

"Of course, I may be more credulous and imaginative than most. Probably why I'm a critic. And I really should know better." He looked down at the book in his hands.

"But that stuff of yours can be mighty convincing." He tilted his head. "Somehow, I can't help but look at some of the old legends—and some of the things that have happened in more recent years, too. Can't help but wonder if we actually are babes of the cosmos, and if we haven't been visited and watched by some form of extra-planetary life at one time or another."

Forell looked closely at his friend. Andorra, he knew, was a clear thinker in his own right. And he just might start a serious analysis—and publish it. He grimaced. It wasn't time for that, he knew. Many years must pass before it would be time.

He placed a hand on the back of Andorra's chair, remembering the words of one of the teachers.

*"Remember, Elwar," he had been told, "your objective is clear, but your methods must be most indirect—even unclear. Some things you must obscure in a mass of obviously imaginative detail, while you bring others to the fore. You must hint. You must suggest. You should never fully explain or deny. And you must never be guilty of definite, direct falsehood.*

*"There may come a time when you will be directly questioned—when discovery of your real background and purpose seems imminent, and you will have to take positive action. For such an eventuality, I cannot outline any steps, or even any definite plan of action, since I neither fully understand many of the factors involved, nor have any way of knowing the circumstances which may arise. You'll have to prepare yourself for almost anything, always keeping in mind the peculiarities and capabilities of your own people."*

It looked as though the time might have come. If Andorra, a clever, influential critic, should guess at the real background and the sources of the Forell tales, and if he should misunderstand the motives behind those tales, he would probably publish his thoughts. And those thoughts would be widely read. Many would smile as they read and regard the thing as a hoax. But others might start their own analyses. And some of those might come to highly un-



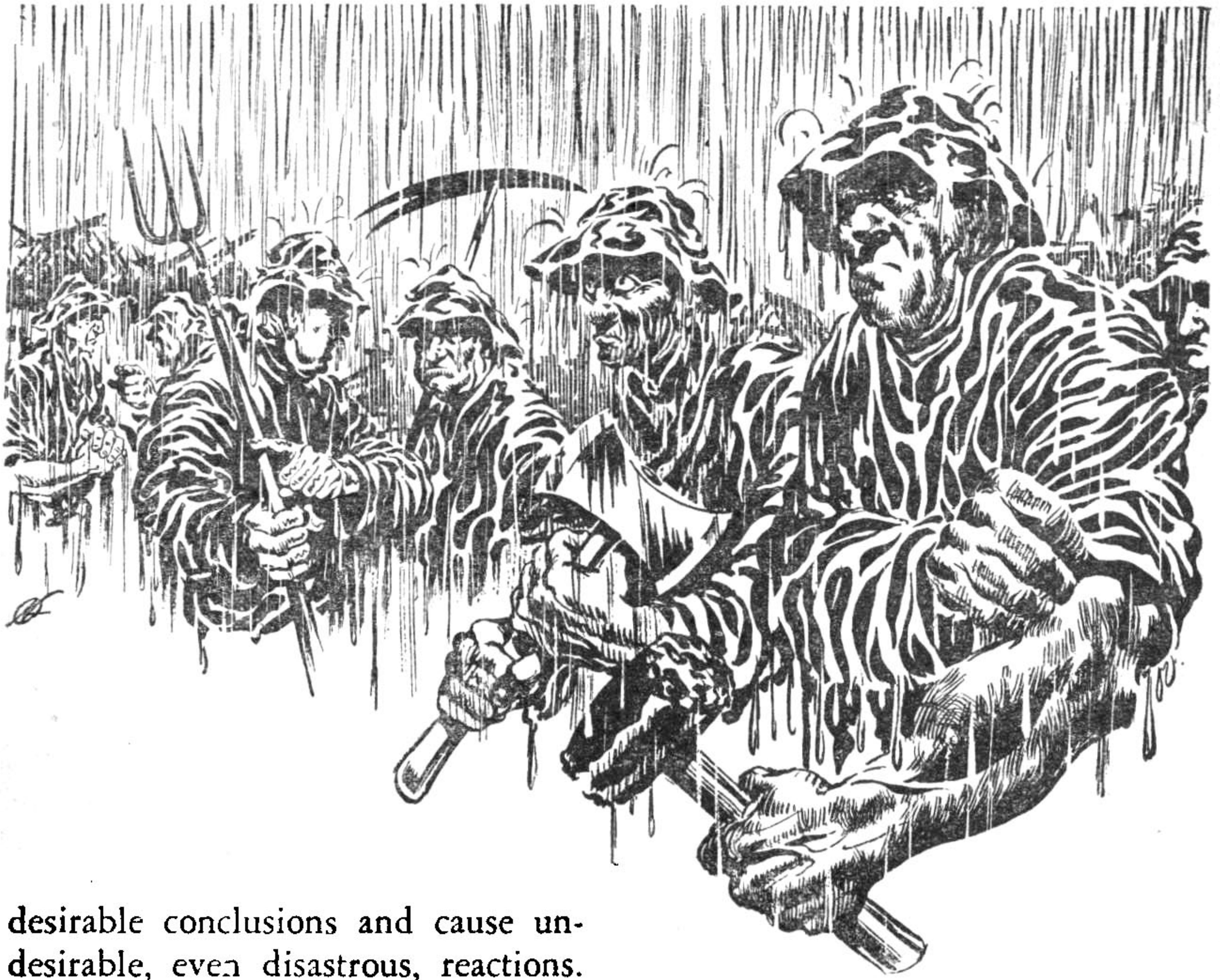

desirable conclusions and cause undesirable, even disastrous, reactions. It would be many generations before clear explanations could be made and definite principles outlined without causing misunderstanding and serious damage. The Forell tales were evasive and preparatory as well as vaguely instructive.

He recovered his self-discipline and waved his hand negligently.

"You know, Charo," he said laughingly, "I've been thinking along similar lines for a long while. Of course, you know I must have built up some sort of fantasy world to base my yarns on?"

Andorra nodded. "That's obvious. I've been wondering about some of your basic theory. Like to see your notes some time."

Forell spread his hands. "You're quite welcome to look them over," he said. "Come on up to my rooms now." He smiled. "As a matter of fact, I've been doing a little extension on my dream world. Built up a little sketch a while ago, and I'm not just sure what to do with it."

As they entered the study, Forell walked across to his desk. He fumbled for a few seconds under the desk, then opened a drawer. For a moment, he paused, looking inside, then pulled out a thin folder. Again, he hesitated. At last, he picked a small, metallic object from the drawer and held it in his left hand.

"Might need this," he told himself. "If I'm wrong, it'll take a sector patrolman to straighten out the mess. And I could be wrong—two ways."

Casually, he placed his left hand in his pocket, then he turned toward Andorra, holding out the folder.

"Here," he said. "See what you think of this one."

Andorra opened the folder, taking out a few sheets of paper. He read for a moment, then looked up quizzically.

"A little different from your usual style, isn't it?"

Forell nodded, watching the man tensely. "I'm trying something new," he said. "Go ahead and read it, then tell me what you think."

He busied himself with a bottle and glasses.

INFORMAL MEMO

130-263

From: Explorations Officer, Sector Nine

To: Ecological Officer

Subject: Incident Report

Enclosed is the file on that recent occurrence on Planet 3-G3-9/4871, consisting of the certificates and statements of the various officers and guardsmen concerned, together with a digest of the interrogation of Elwar Forell, a young planetary native, who appears to have been the instigator.

It seems to me that something is seriously wrong with our system of operation, at least on the subject planet. After all, our operations have the purpose of research and observation, with a view to protection and

development. Certainly, we cannot create chaos. And knowledge of our existence by very young cultures would certainly cause just that. We've got to clear this up in a hurry. The Elder Galactics are most certain to be unhappy about it in any event, and I don't like to make them unhappy.

Obviously, there was a chain of errors, and some of our people concerned will have to be reassigned for further training, but that's just the beginning. I've recalled all the observers from this planet, pending reorganization, and we've got to come up with an answer that'll prevent further occurrences of this nature, as well as covering this affair on the planet concerned.

I realize that the situation has some of the elements of comedy, and I presume that it will eventually be regarded with considerable amusement, but right at the moment, my sense of humor is working very poorly.

I have a few ideas of my own, but would like to have your recommendations and those of other section officers before I make any final decision or report. I am calling a conference on this incident at 280.1000, so make a full investigation on this, and give me some practical recommendation as soon as possible.

CIJORN

6 enclosures

STATEMENT

I, Florand Anremdor, am assigned

ASTOUNDING SCIENCE FICTION

to the Communications Branch, Exploratory Section, Sector Nine.

At 261.0196, I was on duty in the emergency communications room at Increment Four. A call came in from Resident Station number fourteen, Planet 3-G3-9/4871, requesting emergency condensation over the immediate station area. Co-ordinates were not given and I checked the planetary co-ordinates with the call sign and the Communications List. I added these to the message and forwarded the request to the Patrol Duty Officer for his action.

There was no visual on the call, but the voice sounded urgent. I relayed the request without requiring special authentication, since the station was precisely on the correct settings, no inimical culture is known to be operating in this sector, and the coded call was correct. At the time, I had no way of suspecting that this was not a genuine emergency call.

Florand Anremdor  
Comm. 1/c

#### CERTIFICATE

I, Captain Binkar Morancos, am assigned to the 334th Vector, which is presently under the orders of the Commander, Sector Nine.

I was assigned as Sector Patrol Duty Officer at 261.0200, when a message was relayed from Increment Four, requesting emergency condensation on a planet in that increment. I checked the co-ordinates and data furnished, consulted the situation chart, and instructed Cruiser P-4730,

**INDIRECTION**

Captain Klorantel commanding, to carry out the mission.

Since the message came through normal channels, I had no doubt as to its authenticity, and treated it as routine. I felt that the cruiser commander could deal with the matter at his discretion.

Binkar Morancos  
Capt. StG(C)

#### CERTIFICATE

I, Captain Corrondao Klorantel, am in command of the Stellar Guard Cruiser *Myloren*, number P-4730. I am assigned to duty with the 334th Vector, which is operating in Sector Nine.

The *Myloren* was on routine patrol in the Fourth Increment at 261.0203, when a message was received from Sector Headquarters, giving co-ordinates on Planet 3-G3-9/4871, with a request for emergency condensation. I proceeded to the subject planet and took position outside the atmosphere. Visual checks failed to show any emergency condition on the surface, though a burned-out area was noted in the forest a short distance to the planetary south of the station concerned. A call was made to the resident station, requesting clarification of the request, and the answer proved to be unsatisfactory.

There was no visual transmission, and the voice was strongly accented. The message gave insufficient data for action, contained no identification, and was in improper form for station-to-ship contact. I decided to

make contact by other means, and shifted my secondary communicator to the guardsman's personal settings, requesting further information, suitable identification, and confirmation of the request. Guardsman Jaeger immediately informed me that the call was spurious, stating that he was away from his station, and that he would return immediately. During the conversation, I noted that full condensation was taking place to atmospheric limits.

I called Auxiliary, and Technician Melran stated that his control circuits were inoperative and that he was tracing the difficulty. He cleared the trouble, but condensation had already been established and precipitation had commenced. I ordered re-absorption, which was started as soon as repairs had been accomplished.

At the request of Guardsman Jaeger, we stood by to render aid if necessary, maintaining contact with his station. At 0572, Jaeger requested immediate evacuation for himself and for one other person. I entered atmosphere, made planetfall with nullified visibility, and took off the guardsman and a young native. During the evacuation, I noted a number of natives armed with various implements, who were attempting to break their way into the station. Guardsman Jaeger fired his demolitions as he left, firing the screen generator with his last flare. For a few minutes, the natives fell back before the flames, but they were entering the station by the time we cleared the

planet. It is believed that the installation was completely destroyed.

Corrondao Klorantel  
Capt. StG(C)  
Commanding P-4730

#### STATEMENT

I, Danaco Melran, am assigned to the Patrol Cruiser *Myloren*, number P-4730, for duty.

At 261.0204, I was on duty in Auxiliary Equipment when Captain Klorantel called, informing me that a request had come in for emergency condensation. He told me to set up and await execution order. I preset two forward radiators for forty kilometers at low condensation, with a three kilometer radius at surface. I then put the controls on automatic trigger, notified the captain, and went on with my normal duties. At 0221, we came out of trans-light, and I adjusted my equipment for slow-drive operation.

At 0223, my indicators showed activity on the forward radiators. I checked and discovered that full power was being applied. Attempts to override the automatics were unsuccessful, and while I was attempting to clear the trouble, the captain called again, saying that the request was false, and asking why I had turned the radiators on. I told him that the controls were jammed, and he instructed me to make repairs and set up re-absorption.

I discovered a short between the automatic trigger and the ship's secondary communication antenna. After clearing this, I found trouble in the

control section of the condensation driver. The automatic trigger had become fused, and the control paths were shorted to full-drive throughout. The sub-assemblies were replaced and trouble cleared by 0300. I then set up re-absorption as ordered.

Danaeo Melran  
Eq Tech 3/c

#### STATEMENT

I, Franz Jaeger, am Resident Guardsman at Station Fourteen, Planet 3-G3-9/4871.

I have been assigned to my station for eight planetary years for survey and observation duty. During the past five years, I have employed Elwar Forell, the son of a local peasant, to keep the living quarters clean and to do general work about the station. I have never discussed the possibilities of extra-planetary civilization with him, and I have been careful to exclude him from knowledge of my technical equipment, which I have kept in a secure room in accordance with regulations. I have presented myself to him, as well as to all the villagers in my area, as a scholar, tired of city life, and desirous of a quiet existence.

There has been a drought in part of my area for the entire season. We have suffered from one forest fire and there is a strong possibility of others. Crops are doing very badly, and the peasants have been complaining bitterly. This is not an unheard-of situation, but it has caused considerable discomfort and worry, since there is a very definite threat of

famine. There have been numerous attempts to obtain rain by occult means, and I have been personally approached on the matter. For some time, the villagers in the immediate area of the station have regarded me as a sorcerer, and I have been asked to cast a spell to cause rain.

I had considered a request for light condensation, but had hesitated to make such a request, since I felt that rain closely following the villagers' petition to me would confirm their supernatural beliefs, which I have attempted to discourage.

At 261.0223, I was on a routine tour of my area. I received a call from the cruiser *Myloren*, Captain Klorantel commanding, asking for further information on a request for emergency condensation. I informed him that I had made no such request, adding that a light rain would be desirable if he were in position and prepared to radiate.

During the conversation with Captain Klorantel, I noted that the sky was darkening. There were several flashes of lightning, and I felt the signs of imminent, heavy rain. I promptly started back to my station.

Upon my arrival, I discovered that Elwar had managed to open the communications room and had been using the equipment. He was extremely frightened, and made incoherent remarks about talking to a demon. When I attempted to question him as to how he had opened the room, and where he had learned the operation of the communications equipment, he

became hysterical and I could find out precisely nothing.

By this time, it was raining violently. There was a high wind. Several trees had been blown down and lightning was frequent. A flood was starting down the mountainside toward the village, threatening severe damage. It was quite apparent that crops, such as they were, would be almost completely destroyed.

At the time, I could do little to remedy the situation. I re-established contact with the cruiser, informed Captain Klorantel of the situation, and requested that he stand by. I then turned on my viewsphere to keep watch on the village from the communications room. Since Elwar had been in the room on several previous occasions, I saw no reason for excluding him. On the contrary, I thought it would be advisable to keep him with me, since I felt that he would be seriously injured if he were turned loose in the village. I do not believe he would have survived the fury of the villagers, who had taken shelter, and were watching the destruction of their crops.

The flood had become a torrent, which overflowed the banks of the village brook, tore at the bridge, and swept through the lanes. In the fields, grain was beaten into the ground and it was clear that the villagers would have little or no harvest to celebrate during the approaching festival. The wind grew in force, lashing at the tall festival pole, which bent, crashed down in the village square, and par-

tially demolished the front of the inn.

During this period, there was no human activity, since everyone had taken what shelter he could find.

At 0448, the rain slackened, the wind died down, and people started gathering in the square. For a time, they milled about, wading through the ebbing flood. They examined the damage, then they gathered in groups, talking earnestly.

The dry wind came up at 0510, and by 0550, the entire village was on the march toward my station. Their intentions were quite easy to determine. They were armed with pitchforks, scythes, axes, and other tools which could be converted to offensive use. I established a protective screen, but realized that to set up a permanent defense would be impractical and even harmful. I therefore called the cruiser, requesting evacuation for myself and for young Forell. Prior to evacuation, I demolished all my fixed equipment, so that the only things left for the villagers to find when they entered the station were damaged remains of those things normal for a recluse scholar of their era.

Franz Jaeger  
Observer 2/c

INFORMAL MEMO

130-265

From: Evaluations Officer  
To: Explorations Officer  
Subject: Interrogation

Enclosed is a digest of the interrogation of one, Elwar Forell, who

**ASTOUNDING SCIENCE FICTION**

was evacuated from forty-eight seventy-one, in company with Guardsman Jaeger. This boy was abjectly terrified and had to be calmed several times during questioning. He was pitiably hysterical when recalling his conversation with Captain Klorantel, who, you will remember, is a capriform humanoid.

The subject appears to be an intelligent specimen of his race, and when he had conquered his hysteria, was extremely co-operative, showing active interest in his surroundings. I believe he would be able to assimilate training, and would make a valuable addition to the Stellar Guard. I recommend his retention and training.

If Elwar is a typical "son of a simple peasant," and if the planet from which he comes has any considerable number of "simple peasants" with sons like him, I can foresee some strangely interesting problems in connection with further dealings on that planet. FONZEC

1 enclosure

#### DIGEST

Interrogation of Elwar Forell, native of Planet 3-G3-9/4871.

"My Masters, I did mean no harm, but only good. I have long known that my master was possessed of power denied to most men. When I was apprenticed to him five years ago, I thought I would one day learn some of the dark secrets of the hidden worlds, but never did my master mention aught of those secrets he so

surely knew. He taught me only of those things known to the scholars. He told me of reading, of writing, and of ciphering, and taught me many facts of our world which are known to the learned. I wished to know of many other things, but of these he was silent. Even so, I am grateful for his teachings, for how else could the son of a simple peasant gain the knowledge of the scholars?

"I saw that my master often repaired to a room which I was never allowed to enter. This room he cleaned himself. And he always entered in the greatest of secrecy, being quite cross with me when I once betrayed curiosity. I remained curious, however, and fell at last to watching him in secret as he opened the door.

He slid aside a secret panel, then turned a wheel this way and that, finally pushing a handle. I watched, at last learning to what numbers he did turn the wheel, and how he pushed the handle. During his absences, I went sometimes to that room of magic, and I read the books of power, though there was much I could not read, since much of the writing was in strange tongues and I dared not ask my master the meanings of the strange words. But for his own convenience, my master had written many instructions plainly. And these, I read.

"I did learn that there were powers beyond those of men. I learned that these strange instruments on the table did have strange ability to call

forth demons and spirits, but never until that day did I dare touch other than the books and papers. And those I took great care to restore to their original condition.

"For three months past, my father's land and the fields of his neighbors have been dry. During this time, there has been no rain, nor hint of rain, and the peasants have cried out for relief. They have appealed even to my master, who has told them that he has no strange powers—that he can do naught to call up rain. But they did not believe him, nor did I, Elwar, who knew better than this. I had seen the books of power, and I knew the demons could cause the skies to deliver water if rightly asked. So, I visited the room of magic upon the occasions of my master's absence. And I tried to decipher his writings that I might find the means to ask for the skies to open. Always, when I felt my master's presence approaching, I left the room, taking care to properly lock the door and to hide all evidence of my entry.

"On that day of direful events, I found a paper in my master's hand. It mentioned fire in the forests. It mentioned rain. And it had on it words of power.

"For a time, I practiced the strange syllables. Many times did I speak them aloud, then I pressed the bosses on the table, as shown by one of the books. There was a light. Then, the great ball glowed with color, to show me the first demon.

"He spoke. And I conquered my fear, to repeat the syllables I had

labored to learn. Once again, he spoke, and I could not understand him. I could think of nothing but to say again those words which I hoped would bring the rain we so badly needed. I took my hands from the bosses and stood, wondering what would happen. The ball became dark.

"I stood, waiting. And nothing happened. Finally, thinking nothing was to occur, I turned and started to leave the room. Then, a great voice spoke. Again, the wall was alight. Within it was a fearsome demon who glared at me ferociously and demanded something in that tongue of power. I could not think. I stood, trembling fearfully. And he spoke again. Then did I repeat again the words I had learned, and ran from the room.

"It became dark. The lightnings flashed, and the rain fell, and my master came, but not as I had ever seen him before. He did not walk from the forest as was his wont, but appeared before me from the air. I started back in fright, for now I was certain beyond doubt that he was a man of great wizardry. I thought he would beat me, or possibly cast me under a spell.

"Never has he beaten me, always saying that it was wrong to beat an apprentice, and that those who so did were lacking in their senses. And this is but another proof of his sorcery, for who, other than a sorcerer, could handle his servants without beating them?

"I dared do nothing other than to



tell him of my misdoing, and he rushed to the room, taking me with him. He pressed the bosses, turning one that I had not known of, and the demon appeared again and talked with him. Then, my master made strange passes about the instruments and the village was shown in the ball.

"At last the rain stopped. A wind blew—hot and dry, as from the pit—and the people came and did try by violence to enter. But they could not. At last, the great machine came, and though we could not at first see it, we entered and were carried away through the sky.

"The people watched the house burn, then entered, to scatter the ashes.

"And I am here, and afraid."

Doer Kweiros flipped off the playback and gazed at the unresponsive wall. He rubbed the back of his head, looked at the viewsphere, then checked the playback index and tapped the rewind.

"Oh, me," he complained sorrowfully, "how do we get into these things?"

He looked toward the communicator controls unhappily, then reached out and dialed a number. The sphere lit and an alert face looked at him inquiringly.

"How is that Forell boy?"

"Soaking up information like a sponge, sir."

Kweiros nodded. "Gathered he might," he remarked. "Send him up here, will you? And have Jaeger come with him."

"Yes, sir."

Kweiros snapped the communicator off, sat back to drum idly on his desk, then got up and walked over to his master file control board. He glanced at the index, then punched out a sequence on the buttons. There was a subdued hum and a door opened. Kweiros reached into the compartment, to take out several tape reels. He glanced at them, nodded, and went back to the desk, where he spread them out and looked from one to another. Finally, he selected one of the smaller reels and started to thread it into the playback.

There was a light tap on the door and he looked up.

"So soon? Come in."

A tall, sharp-featured guardsman entered and stood at attention. Beside him was a boy, who looked curiously and a little fearfully at the officer, who waved to chairs.

"Sit down, both of you. I'm not going to claw you. Just want to go over a few things. I've some ideas, but I want to be sure of a couple of points." The captain glanced at the reels before him.

"One thing puzzles me, Jaeger. Why did you have notes in the planetary language in your communications room?"

Jaeger stirred uneasily. "I started doing that some time ago, sir," he explained. "You see, their language is quite dissimilar to either my own or to Galactica, and I have yet to learn to think in it. I wanted to avoid any possibility of lapsing away from it, so I translated my instruc-

tions and notes, hoping to keep myself constantly reminded to refrain from using Galactica at any time." He spread his hands. "I suppose—"

Kweiros waved. "Logical, I presume," he admitted. "Anyway, that's done, and we can't do much about it now. Now for another thing." He glanced at the tape reels. "I noticed that the villagers in your area regarded you as a sorcerer. What cause did they have to form such an opinion?"

"None, sir, that I know of." Jaeger shook his head.

Kweiros looked at the boy. "Elwar?"

"Why, all the village knew it, Master." The boy shook his head. "One had but to be near Master Jaeger for a time, and he could feel the power, just as I can feel it now." He shook his head again. "But it is very strong, Master. You must be one of the ones of truly great power."

Kweiros looked speculatively at Jaeger.

"I understood they were nontelepaths. All the reports agree on that."

"Definitely, sir, they are. They're absolutely mute. Not a trace of radiation, even when they're close. And they don't receive. You can try it now, sir. It's just like punching into space itself. No resistance, no reflection, just nothing."

"Shield?"

"No, sir. Just no indication. Makes me feel as though I were in free space with a dead drive."

Kweiros looked for a moment at Jaeger, then sent out a probing

thought, searching for some indication of mental activity from the boy. But there was nothing. It wasn't anything like a shield, he thought. It seemed more like an infinite baffle.

But there was some reaction. The boy shrank back in terror.

"Please, Master, he begged. "Do not place me under enchantment." He held up his hands in a peculiar gesture.

"What made you do that?" Kweiros raised a hand slowly, palm out. "I have no intention of harming you."

"But I could feel you, trying to cast me under a spell."

"You... felt me?"

"To be sure, Master, just as I have felt the same power from my master, Jaeger. But this was far stronger. It hurt. And it seemed as though you wanted me to do something."

Kweiros nodded. "I think I'm getting an idea," he remarked. "And it scares me a little. They're not really nontelepathic, any more than the Kierawelans, for example, are non-vocal. I think we've got something here that's almost unique in the galaxy." He rubbed his neck. "Excuse me a few minutes. I want to check something in one of these tapes."

Jaeger nodded and leaned back in his chair, looking curiously at the boy beside him, then back at his superior, who had selected a tape reel. He threaded it into the playing heads, put on a headband, and snapped a switch. Jaeger and the boy watched as Kweiros leaned back.

The officer's face became vacant, then twisted, seeming to reflect painful mental effort. Slowly, he leaned forward again, touching another switch. Then, he sank back, to concentrate on his thoughts.

Jaeger looked again at the boy, who was sitting tensely, his hands gripping the arms of his chair, his eyes fastened fearfully on the officer before him. As Jaeger watched, Elwar half rose from his chair, then sank back, his face appearing to mirror Kweiros' efforts.

At last, Kweiros sat up. Shakily, he removed his headband and snapped the playback off.

"Long time since I checked that tape," he said. "Pretty rugged stuff, and highly speculative. Always gives me a headache." He shook his head as he looked at Elwar.

"And this makes it even worse. It was bad enough as pure speculation, but we've got something real here. Something rough. For one thing, we have got a planet where no one but native operatives stand a chance of working. For another we—" He cupped his chin in his hands and examined Elwar closely.

"Do you really want to learn the secrets you looked for in the books, Youngster? Do you still want the secrets you first thought you might learn?"

The boy seemed to withdraw a little. "I have a great fear," he admitted tremulously.

"You haven't been injured or mistreated, have you?"



"No, Master, but—" Elwar looked toward the door.

"And you won't be," he was told reassuringly. "Now you just go ahead on back to your quarters."

As the door closed, Kweiros turned to Jaeger.

"Think we'll put you on special assignment. For the next few cycles, you'll act as a private tutor. Then you can go back to Main Base with Elwar while they give him his training."

Jaeger raised his eyebrows. "Yes, sir," he said doubtfully. "You think the boy will develop?"

Kweiros nodded. "I'm quite sure of it," he said. "And he's got a big job ahead of him. He may be instrumental in preventing a major disaster." He waved at the tape reels.

"I got that little tape out just on an off chance," he added. "Didn't really expect to find anything, but—" He flipped his hands out. "Anyway, I pulled it." He leaned forward, looking at Jaeger.

"We may have run into a second, or even third growth culture," he said slowly. "Once, before some ancient war of destruction, the people of this planet might have been normally telepathic." He closed his eyes for an instant. "Possibly they were unable to use their telepathic power. And equally possibly, they could have had a highly developed mechanical civilization. Something went wrong." He waved at the tape reel.

"In this reconstruction, there's a hypothesis on just such a situation.

Here, a race reaches high development and wrecks itself—leaving no trace of its accomplishments. Growth starts over from the most meager of beginnings. Survival becomes a matter of the most bitter conflict, with everyone becoming a hunter and being hunted in his turn. In this situation, detection of an enemy becomes vital." He grinned wryly. "Can you imagine what would happen to someone who radiated his thoughts?"

Jaeger ran a finger over his lips. "He'd be easy to locate," he mused. "And he'd have a hard time evading an enemy."

"Precisely." Kweiros nodded. "And he'd never be able to approach his prey. In short, he'd fail to survive. Complete telepathic blankness would have a high survival value. But an ability to detect mental radiation would still be a big help." He waved a hand.

"So, a race like this one could evolve. And the author of this tape extrapolated from there. A normal telepathic reception will be accompanied by a slight feedback. A completely black body, however, will neither radiate nor feed back. It merely absorbs energy and, unless it's super-imposed on a reflective background, it leaves no trace. Since nothing in nature other than a telepathic mind can reflect telepathy, no background would survive for long." He frowned a little.

"Of course, no mind we are familiar with could act as a telepathically black body, but this author hypothesized a race that could do just that—

plus. There's a further hypothesis of an ability to detect and localize radiations as such, without bothering to resolve them."

"Sounds like just what we have here," Jaeger admitted.

"It does, doesn't it?" Kweiros nodded. "And there's a further extrapolation. Some of the members of the elder races have speculated on a sort of second-order telepathy, undetectable to the normal telepath, but capable of noting normal radiation. And some of the speculations seem to make sense—though they're a little confusing. If you don't have a specific sense, it's difficult to visualize it, or even to speculate on its presence." He drew a deep breath.

"That leads us into a real problem. Our people roamed around this planet for several cycles this time. And there may have been others before us, who didn't record their visits, other than in the minds and legends of the natives. And there may be other legends from that other, older culture." He shrugged.

"We picked up what we could on the culture, but we didn't get the full story on them. And we've probably left a thousand legends behind us, including that beautiful mess at your station." He grinned.

"Right now, their folklore is loaded with sorcerers, warlocks, wizards, and what not. After all, whatever their past is, they're primitive now. So those stories are going to grow and continue. Eventually, long before they really develop a stabilized ethic, someone's going to collate that whole

mess. And do you know what he'll come up with?"

"Us?"

"Us, yes. Us, in a distorted form." Kweiros nodded emphatically. "They will come to a full realization that there are advanced entities running around the cosmos, entities that have all kinds of mysterious powers. And they'll invent still more powers and characteristics—mostly bad." He spread his hands, then laid them on the desk in front of him.

"That way, they could develop a hopeless, planet-wide trauma—a sort of super inferiority complex—and they could contract on themselves, devote their time to an intensive study of demonology, and very possibly come apart at the seams.

"Or, they could do something else. I was watching Elwar while I was checking that tape. Did you notice anything peculiar?"

"He seemed disturbed."

"As though he were sensing my thoughts?"

"Something like that. But—"

Kweiros nodded. "But I had a shield up. You could detect no trace of mental action. Right?"

"Yes, sir."

"That's what I thought." Kweiros shook his head and looked closely at Jaeger.

"Can you imagine," he added, "a primitive race with the power to detect a galactic by his thoughts? And can you imagine that power developing until that detection is possible at interstellar ranges, with members of

that race being able to pick up faint impressions from received thoughts—distorted impressions? And can you imagine that same race, ignorant of the humanic equations, devoid of a stable ethic, superstitious, distrustful and fearful of advanced entities? They would be undetectable by normal telepathic means, you know. And suppose they were disposed to destroy what they could not understand." He frowned.

Jaeger looked back at him, his eyes becoming wide. Suddenly, his gaze defocused and he looked aside, to stare unseeingly at the floor.

"Something's got to be done, sir," he said reluctantly.

Kweiros nodded. "Something's got to be done," he agreed. "Of course, there's another side to the picture. If this race develops and learns, they'll be just as valuable to the galaxy as they would otherwise be dangerous." He looked toward the door.

"And our boy out there is one of the few who can help in this situation. He's going to have to work out counter stories—amusing stories—about all those magical creatures his people tell about. He's going to have to hint at the possibilities of close co-ordination and co-operation between members of his own species. And he's going to have to suggest the possibility of friendly co-operation between his species and others." He drew a deep breath.

"And he's going to have to do all this without taking any risk of exposing the existence of other, more advanced species in the galaxy." He

brushed a hand across his head, then pressed the back of his neck, kneading the skin.

"These stories of his, he'll have to publish. He'll have to get them circulated all over his planet, if he can. Possibly we can give him some indirect help, but he's going to have to carry a good share of the load.

"He knows his own people as we could never hope to. And he'll have to be thoroughly educated, so he can say what he wants to. And he'll have to be fully aware of the humanic equations and all their connotations. If he's to have any direct help, he'll have to choose his helpers from among his own people, and he'll have to choose carefully." Kweiros thrust at his temple with the heel of a hand, then shook his head violently.

"Somehow, he's going to have to accentuate any legends he may be able to find which present a favorable light on co-ordination and co-operation, and he'll have to invent more. And all those other legends—the ones which treat of superstition and destructive force—will have to be reduced to the realm of the story-book, submerged under a layer of amused condemnation, and kept there. All these things, that youngster is going to have to do.

"It's your job to help teach him."

Forell watched his friend closely as the critic laid aside the last page.

Andorra sat for a moment, his head cocked in thought. Then, he picked up the last page and looked at it again. Finally, he laid the sheet

aside. He looked at his friend with a wry smile, then picked up his wine-glass, looking at it quizzically.

"Do you always give your own name to one of your characters?"

Forell's grip tightened on the small object in his hand.

"Oh, sure," he said. "Gives me a better identification. If I can get into the story, it's easier to draw the reader in." He forced a casual smile. "I'll change that name later, of course."

"I see what you mean." Andorra sipped from his glass.

"You know," he added, "a couple of hours ago, I was almost ready to get excited about the idea of a cosmos full of super beings. And I even might have dreamed up something like this myself—and more than half believed it." He shook his head.

"But when a fantacist like yourself comes up with it, and makes it look so nicely possible, the idea almost looks foolish. After all, Elwar, if you actually were the guy in that little sketch of yours, you'd hardly be asking me to read it, now would you?" He looked down at the papers, then raised his head again, frowning.

"'He'll have to choose his helpers from among his own people,'" he quoted. "All these things, that

youngster is going to have to do.'" He sipped again from his glass, keeping a searching gaze on his friend.

"And on the other hand, if your story here should be true, you just might be asking me to read it, for one reason or another." He raised his glass, examining the bright liquid within it.

Elwar tensed, his hand coming part way out of his pocket.

Suddenly, Andorra set the glass down and leaned forward, hands gripping his knees.

"Tell me, Elwar," he begged, "this isn't a hoax, is it? Surely, no one could be so warped as to present a friend with something like this and then to laugh it off?"

Forell drew a deep breath and examined his companion closely. At last, his left hand relaxed a little.

"It's no hoax," he admitted.

Andorra sighed and leaned back.

"And you can use help? You're asking me?"

He paused, waiting as Forell nodded, then spread his hands.

"You know," he said, "it shouldn't take me too long to fix it so I would not be missed too much for a few years." He looked at the wall.

"It must be quite a training course."

THE END



*Situations can pile up on a man so they drive him to desperate action. Usually, though, the desperate action is along the wrong line; properly applied, it would solve the problem . . .*

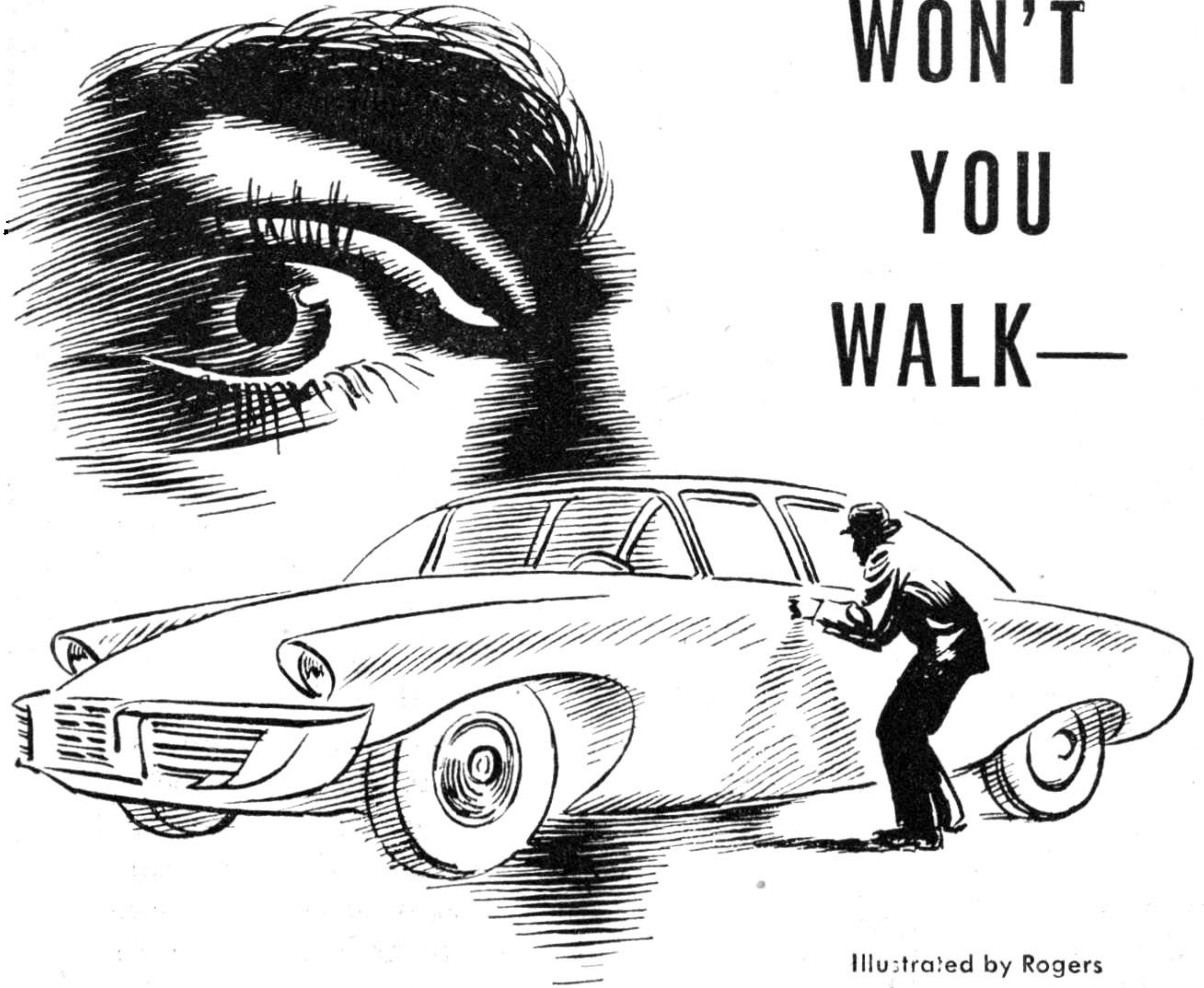

**WON'T  
YOU  
WALK—**

Illustrated by Rogers

## **BY THEODORE STURGEON**

Joe Fritch walked under the moon, and behind the bridge of his nose something rose and stung him. When he was a little boy, which was better than thirty years ago, this exact sensation was the prelude to tears. There had been no tears for a long time, but the sting came to him, on its oc-

casions, quite unchanged. There was another goad to plague him too, as demanding and insistent as the sting, but at the moment it was absent. They were mutually exclusive.

His mind was a jumble of half-curses, half-wishes, not weak or pale ones by any means, but just unfin-

**ASTOUNDING SCIENCE FICTION**



ished. He need not finish them, any of them; his curses and his wishes were his personal clichés, and required only a code, a syllable for each. "He who hesitates—" people say, and that's enough. "Too many cooks—" they say wisely. "What's sauce for the goose—" Valid sagacities, every one, classic as the Parthenon and as widely known.

Such were the damnations and the prayers in the microcosm called Joe Fritch. "Oh, I wish—" he would say to himself, and "If only—" and "Some day, by God—"; and for each of these there was a wish, detailed and dramatic, so thought-out, touched-up, policed and maintained that it had everything but reality to make it real. And in the other area, the curses, the code-words expressed wide meticulous matrices: "That Barnes—" dealt not only with his employer, a snide, selfish, sarcastic sadist with a presence like itching-powder, but with every social circumstance which produced and permitted a way of life wherein a man like Joe Fritch could work for a man like Barnes. "Lutie—" was his wife's name, but as a code-word it was dowdy breakfasts and I-can't-afford, that-old-dress and the finger in her ear, the hand beginning to waggle rapidly when she was annoyed; "Lutie—" said as the overture to this massive curse was that which was wanted and lost ("Joe?" "What, li'l Lutle?" "Nothing, Joe. Just . . . Joe—") and that which was unwanted and owned, like the mortgage which would be paid off in only

eighteen more years, and the single setting of expensive flowery sterling which they would never, never be able to add to.

Something had happened after dinner—he could almost not remember it now; what bursts the balloon, the last puff of air, or the air it already contains? Is the final drop the only factor in the spilling-over of a brimming glass? Something about Marie Next Door (Lutie always spoke of her that way, a name like William Jennings Bryan) and a new TV console, and something about Lutie's chances, ten years ago, of marrying no end of TV consoles, with houses free-and-clear and a car and a coat, and all these chances forsworn for the likes of Joe Fritch. It had been an evening like other evenings, through 10:13 p.m. At 10:14 something silent and scalding had burst in the back of Joe's throat; he had risen without haste and had left the house. Another man might have roared an epithet, hurled an ashtray. Some might have slammed the door, and some, more skilled in maliciousness, might have left it open so the angry wife, sooner or later, must get up and close it. Joe had simply shambled out, shrinking away from her in the mindless way an amoeba avoids a hot pin. There were things he might have said. There were things he could have said to Barnes, too, time and time again, and to the elevator-starter who caught him by the elbow one morning and jammed him into a car, laughing at him through the gate

before the doors slid shut. But he never said the things, not to anyone. Why not? Why not?

"They wouldn't listen," he said aloud, and again the sting came back of his nose.

He stopped and heeled water out of his left eye with the base of his thumb. This, and the sound of his own voice, brought him his lost sense of presence. He looked around like a child awakening in a strange bed.

It was a curved and sloping street, quite unlike the angled regimentation of his neighborhood. There was a huge elm arched over the street-lamp a block away, and to Joe's disoriented eye it looked like a photographic negative, a shadow-tree lit by darkness looming over a shadow of light. A tailored hedge grew on a neat stone wall beside him; across the street was a white picket fence enclosing a rolling acre and the dark mass of just the house he could never own, belonging, no doubt, to someone people listened to. Bitterly he looked at it and its two gates, its rolled white driveway, and, inevitably, the low, long coupé which stood in it. The shape of that car, the compact, obedient, directional eagerness of it, came to him like the welcome answer to some deep question within him, something he had thought too complex to have any solution. For a moment a pure, bright vision overwhelmed and exalted him; his heart, his very bones cried *well, of course!* and he crossed to the driveway, along its quiet grassy margin to the car.

He laid a hand on its cool ivory flank, and had his vision again. At the wheel of this fleetfooted dream-car, he would meet the morning somewhere far from here. There would be a high hill, and a white road winding up it, and over the brow of that hill, there would be the sea. Below, a beach, and rocks; and there would be people. Up the hill he would hurtle, through and over a stone wall at the top, and in the moment he was air-borne, he would blow the horn. Louder, *bigger* than the horn would be his one bright burst of laughter. He had never laughed like that, but he would, he could, for all of him would be in it, rejoicing that they listened to him, they'd all be listening, up and down the beach and craning over the cliff. After that he'd fall, but that didn't matter. Nothing would matter, even the fact that his act was criminal and childish. All the "If only—" and "Some day, by God—" wishes, all the "That Barnes—" curses, for all their detail, lacked implementation. But this one, this one—

The window was open on the driver's side. Joe looked around; the street was deserted and the house was dark. He bent and slid his hand along the line of dimly-glowing phosphorescence that was a dashboard. Something tinkled, dangled—the keys, the keys!

He opened the door, got in. He could feel the shift in balance as the splendid machine accepted him like a lover, and they were one together. He pulled the door all but

closed, checked it, then pressed it the rest of the way. It closed with a quiet, solid click. Joe grasped the steering wheel in both hands, settled himself, and quelled just the great trumpeting of laughter he had envisioned. *Later, later.* He reached for the key, turned it.

There was a soft purring deep under the hood. The window at his left slid up, nudging his elbow out of the way, seated itself in the molding above. The purring stopped. Then silence.

Joe grunted in surprise and turned the key again. Nothing. He fumbled along the dashboard, over the cowl- ing, under its edge. He moved his feet around. Accelerator, brake. No clutch. A headlight dimmer-switch. With less and less caution he pushed, turned and pulled at the controls on the instrument panel. No lights came on. The radio did not work. Neither did the cigarette lighter, which startled him when it came out in his hand. There wasn't a starter anywhere.

Joe Fritch, who couldn't weep, very nearly did then. If a man had a car burglar-proofed with some sort of concealed switch, wasn't that enough? Why did he have to amuse himself by leaving the keys in it? Even Barnes never thought of anything quite that sadistic.

For a split second he glanced forlornly at his glorious vision, then forever let it go. Once he sniffed; then he put his hand on the door control and half-rose in his seat.

The handle spun easily, uselessly

around. Joe stopped it, pulled it upward. It spun just as easily that way. He tried pulling it toward him, pushing it outward. Nothing.

He bit his lower lip and dove for the other door. It had exactly the same kind of handle, which behaved exactly the same way. Suddenly Joe was panting as if from running hard.

Now take it easy. Don't try to do anything. Think. Think, Joe.

The windows!

On his door there were two buttons; on the other, one. He tried them all. "I can't get out," he whispered. "I can't—" Suddenly he spun one of the door handles. He fluttered his hands helplessly and looked out into the welcome, open dark. "*Can't!*" he cried.

"That's right," said a voice. "You sure can't."

The sting at the base of Joe Fritch's nose—that was one of the unexpressed, inexpressible pains which had plagued him ever since he was a boy. Now came the other.

It was a ball of ice, big as a fist, in his solar plexus; and around this ball stretched a membrane; and the ball was fury, and the membrane was fear. The more terrified he became, the tighter the membrane shrank and the more it hurt. If ever he were frightened beyond bearing, the membrane would break and let the fury out, and that must not, must not happen, for the fury was so cold and so uncaring of consequence. This was no churning confusion—there was nothing confused about it. There

was only compression and stretching and a breaking point so near it could be felt in advance. There was nothing that could be done about it except to sit quite still and wait until it went away, which it did when whatever caused it went away.

This voice, though, here in the car with him, it didn't go away. Conversationally it said, "Were you thinking of breaking the glass?"

Joe just sat. The voice said, "Look in the glove compartment." It waited five seconds, and said, "Go ahead. Look in the glove compartment."

Trembling, Joe reached over and fumbled the catch of the glove compartment. He felt around inside. It seemed empty, and then something moved under his fingers. It was a rectangle of wood, about six inches by three, extremely light and soft. Balsa. "I used to use a real piece of glass as a sample," said the voice, "but one of you fools got to bashing it around and broke two of his own fingers. Anyway, that piece of wood is exactly as thick as the windshield and windows." It was nearly three quarters of an inch thick. "Bulletproof is an understatement. Which reminds me," said the voice, stifling a yawn, "if you have a gun, for Pete's sake don't use it. The slug'll ricochet. Did you ever see the wound a ricocheted bullet makes?" The yawn again. "'Scuse me. You woke me up."

Joe licked his lips, which made him shudder. The tongue and lip were so dry they scraped all but

audibly. "Where are you?" he whispered.

"In the house. I always take that question as a compliment. You're hearing me on the car radio. Clean, hm-m-m? Flat to twenty-seven thousand cycles. Designed it myself."

Joe said, "Let me out."

"I'll let you out, but I won't let you go. You people are my bread and butter."

"Listen," said Joe, "I'm not a thief, or a . . . or a . . . or anything. I mean, this was just a sort of wild idea. Just let me go, huh? I won't ever . . . I mean, I promise." He scraped at his lip with his tongue again and added, "Please. I mean, please."

"Where were you going with my car, Mister I'm-not-a-thief?"

Joe was silent.

A sudden blaze of light made him wince. His eyes adjusted, and he found it was only the light over the porte-cochere which bridged the driveway where it passed the house. "Come on inside," said the voice warmly.

Joe looked across the rolling lawn at the light. The car was parked in the drive near the street; the house was nearly two hundred feet away. *Catch ten times as many with it parked way out here*, he thought wildly. *And, I thought Barnes was good at making people squirm. And, Two hundred feet, and him in the house. He can out-think me; could he outrun me?* "What do you want me inside for?"

"Would it make any difference how I answered that question?"

Joe saw that it wouldn't. The voice was calling the shots just now, and Joe was hardly in a position to make any demands. Resignedly he asked, "You're going to call the police?"

"Absolutely not."

A wave of relief was overtaken and drowned in a flood of terror. No one knew where he was. No one had seen him get into the car. Being arrested would be unpleasant, but at least it would be a known kind of unpleasantness. But what lay in store for him in this mysterious expensive house?

"You better just call the police," he said. "I mean, have me arrested. I'll wait where I am."

"No," said the voice. It carried a new tone, and only by the change did Joe realize how—how *kind* it had been before. Joe believed that single syllable completely. Again he eyed the two hundred feet. He tensed himself, and said, "All right. I'll come."

"Good boy," said the voice, kind again. "Sleep sweet." Something went *pfffft!* on the dashboard and Joe's head was enveloped in a fine, very cold mist. He fell forward and hit his mouth on the big V emblem in the hub of the steering wheel. A profound astonishment enveloped him because he felt the impact but **no** pain.

He blacked out.

There was a comfortable forever during which he lay in a dim place,

talking lazily, on and on. Something questioned him from time to time, and perhaps he knew he was not questioning himself; he certainly didn't care. He rested in an euphoric cloud, calmly relating things he thought he had forgotten, and while an objective corner of his mind continued to operate, to look around, to feel and judge and report, it was almost completely preoccupied with an astonished delight that he could talk about his job, his marriage, his sister Anna, even about Joey—whom he'd killed when he and Joey were ten years old—without either the self-pitying twinge of unshed tears nor the painful fear which contained his rage.

Someone moved into his range of vision, someone with a stranger's face and a manner somehow familiar. He had something shiny in his hand. He advanced and bent over him, and Joe felt the nip of a needle in his upper arm. He lay quietly then, not talking because he had finished what he had to say, not moving because he was so comfortable, and began to feel warm from the inside out. That lasted for another immeasurable time. Then he detected movement again, and was drawn to it; the stranger crossed in front of him and sat down in an easy-chair. Their faces were about at the same level, but Joe was not on an easy-chair. Neither was it a couch. It was something in between. He glanced down and saw his knees, his feet. He was in one of those clumsy-looking, superbly comfortable devices known as

a contour chair. He half-sat, half-reclined in it, looked at the other man and felt just wonderful. He smiled sleepily, and the man smiled back.

The man looked too old to be thirty, though he might be. He looked too young for fifty, though that was possible, too. His hair was dark, his eyebrows flecked with gray—a combination Joe thought he had never seen before. His eyes were light—in this dim room it was hard to see their color. The nose was ridiculous: it belonged to a happy fat man, and not someone with a face as long and lean as this one. The mouth was large and flexible; it was exactly what is meant by the term "generous," yet its lips were thin, the upper one almost nonexistent. He seemed of average height, say five, ten or eleven, but he gave the impression of being somehow too wide and too flat. Joe looked at him and at his smile, and it flashed across his mind that the French call a smile *sourire*, which means literally "under a laugh"; and surely, in any absolute scale of merriment, this smile was just exactly that. "How are you feeling?"

"I feel fine," said Joe. He really meant it.

"I'm Zeitgeist," said the man.

Joe was unquestioningly aware that the man knew him, knew all about him, so he didn't offer his name in return. He accepted the introduction and after a moment let his eyes stray from the friendly face to the wall behind him, to some

sort of framed document, around to the side where a massive bookcase stood. He suddenly realized that he was in a strange room. He snapped his gaze back to the man. "Where am I?"

"In my house," said Zeitgeist. He uncrossed his legs and leaned forward. "I'm the man whose car you were stealing. Remember?"

Joe did, with a rush. An echo of his painful panic struck him, made him leap to his feet, a reflex which utterly failed. Something caught him gently and firmly around the midriff and slammed him back into the contour chair. He looked down and saw a piece of webbing like that used in aircraft safety belts, but twice as wide. It was around his waist and had no buckle; or if it had, it was behind and under the back of the chair, well out of his reach.

"It's O.K.," Zeitgeist soothed him. "You didn't actually steal it, and I understand perfectly why you tried. Let's just forget that part of it."

"Who are you? What are you trying to do? Let me out of this thing!" The memory of this man approaching him with a glittering hypodermic returned to him. "What did you do, drug me?"

Zeitgeist crossed his legs again and leaned back. "Yes, several times, and the nicest part of it is that you can't stay that excited very long just now." He smiled again, warm.

Joe heaved again against the webbing, lay back, opened his mouth to protest, closed it helplessly. Then he

met the man's eyes again, and he could feel the indignation and fright draining out of him. He suddenly felt foolish, and found a smile of his own, a timid, foolish one.

"First I anaesthetized you," said Zeitgeist informatively, apparently pursuing exactly the line of thought brought out by Joe's question, "because not for a second would I trust any of you to come across that lawn just because I asked you to. Then I filled you full of what we'd call truth serum if this was a TV play. And when you'd talked enough I gave you another shot to pull you out of it. Yes. I drugged you."

"What for? What do you want from me, anyway?"

"You'll find out when you get my bill."

"Bill?"

"Sure. I have to make a living just like anybody else."

"Bill for what?"

"I'm going to fix you up."

"There's nothing the matter with me!"

Zeitgeist twitched his mobile lips. "Nothing wrong with a man who wants to take an expensive automobile and kill himself with it?"

Joe dropped his eyes. A little less pugnaciously, he demanded, "What are you, a psychiatrist or something?"

"Or something," laughed Zeitgeist. "Now listen to me," he said easily. "There are classic explanations for people doing the things they do, and you have a textbook full. You were an undersized kid who lost his

mother early. You were brutalized by a big sister who just wouldn't be a mother to you. When you were ten you threw one of your tantrums and crowded another kid, and he slipped on the ice and was hit by a truck and killed. Your sister lambasted you for it until you ran away from home nine years later. You got married and didn't know how to put your wife into the mother-image, so you treated her like your sister Anna instead; you obeyed, you didn't answer back, you did as little as possible to make her happy because no matter how happy she got you were subconsciously convinced it would do you no good. And by the way, the kid who was killed had the same name as you did." He smiled his kindly smile, wagged his head and *tsk-tsked*. "You should see what the textbooks say about *that* kind of thing. Identification: you are the Joey who was killed when you got mad and hit him. Ergo, don't ever let yourself get mad or you'll be dead. Joe Fritch, you know what you are? You're a mess."

"What am I supposed to say?" asked Joe in a low voice. Had he run off at the mouth that much? He was utterly disarmed. In the face of such penetrating revelation, anger would be ridiculous.

"Don't say anything. That is, don't try to explain—I already understand. How'd you like to get rid of all that garbage? I can do that for you. Will you let me?"

"Why should you?"

# ZEITGEIST



# FRITCH

"I've already told you. It's my living."

"You say you're a psychiatrist?"

"I said nothing of the kind, and that's beside the point. Well?"

"Well, O.K. I mean . . . O.K."

Zeitgeist rose, smiling, and stepped behind Joe. There was a metallic click and the webbing loosened. Joe looked up at his host, thinking: *Suppose I won't? Suppose I just don't? What could he do?*

"There are lots of things I could do," said Zeitgeist with gentle cheerfulness. "Full of tricks, I am."

In spite of himself, Joe laughed. He got up. Zeitgeist steadied him, then released his elbow. Joe said, "Thanks . . . what are you, I mean, a mind-reader?"

"I don't have to be."

Joe thought about it. "I guess you don't," he said.

"Come on." Zeitgeist turned away to the door. Joe reflected that anyone who would turn his back on a prisoner like that was more than just confident—he must have a secret weapon. *But at the moment confidence is enough.* He followed Zeitgeist into the next room.

It, too, was a low room, but much wider than the other, and its dimness was of quite another kind. Pools of brilliance from floating fluorescents mounted over three different laboratory benches made them like three islands in a dark sea. At about eye-level—as he stood—in the shadows over one of the benches, the bright green worm of a cathode-ray oscil-

ASTOUNDING SCIENCE FICTION



loscope writhed in its twelve-inch circular prison. Ranked along the walls were instrument racks and consoles; he was sure he could not have named one in ten of them in broad daylight. The room was almost silent, but it was a living silence of almost undetectable clickings and hummings and the charged, noiseless *presence* of power. It was a waiting, busy sort of room.

"Boo," said Zeitgeist.

"I beg your . . . huh?"

Zeitgeist laughed. "You say it." He pointed. "Boooo."

Joe looked up at the oscilloscope. The worm had changed to a wiggling, scraggly child's scrawl, which, when Zeitgeist's long-drawn syllable was finished, changed into a green worm again. Zeitgeist touched a control knob on one of the benches and the worm became a straight line. "Go ahead."

"Boo," said Joe self-consciously. The line was a squiggle and then a line again. "Come on, a good loud long one," said Zeitgeist. This time Joe produced the same sort of "grass" the other man had. Or at least, it looked the same. "Good," said Zeitgeist. "What do you do for a living?"

"Advertising. You mean I didn't tell you?"

"You were more interested in talking about your boss than your work. What kind of advertising?"

"Well, I mean, it isn't advertising like in an agency. I mean, I work for the advertising section of the

public relations division of a big corporation."

"You write ads? Sell them? Art, production, research—what?"

"All that. I mean, a little of all those. We're not very big. The company is, I mean, but not our office. We only advertise in trade magazines. The engineer'll come to me with something he wants to promote and I check with the . . . I mean, that Barnes, and if he O.K.'s it I write copy on it and check back with the engineer and write it again and check back with Barnes and write it again; and after that I do the layout, I mean I draft the layout just on a piece of typewriter paper, that's all, I can't draw or anything like that, I mean; and then I see it through Art and go back and check with Barnes, and then I order space for it in the magazines and—"

"You ever take a vocational analysis?"

"Yes. I mean, sure I did. I'm in the right sort of job, according to the tests. I mean, it was the Kline-Western test."

"Good test," said Zeitgeist approvingly.

"You think I'm not in the right sort of job?" He paused, and then with sudden animation, "You think I should quit that lousy job, I mean, get into something else?"

"That's your business. All right, that's enough."

The man could be as impersonal as a sixpenny nail when he wanted to be. He worked absorbedly at his controls for a while. There was a

soft whine from one piece of apparatus, a clicking from another, and before Joe knew what was happening he heard someone saying, "All that. I mean, a little of all those. We're not very big. The company is, I mean, but not our office. We only advertise—" on and on, in his exact words. His exact voice, too, he realized belatedly. He listened to it without enthusiasm. From time to time a light blazed, bright as a photo-flash but scalding red. Patiently, brilliantly, the scilloscope traced each syllable, each pulse within each syllable. ". . . and check with Barnes, and then I order sp—" The voice ceased abruptly as Zeitgeist threw a switch.

"I didn't know you were recording," said Joe, "or I would have . . . I mean, said something different maybe."

"I know," said Zeitgeist. "That red light bother you?"

"It was pretty bright," said Joe, not wanting to complain.

"Look here." He opened the top of the recorder. Joe saw reels and more heads than he had ever seen on a recorder before, and a number of other unfamiliar components. "I don't know much about—"

"You don't have to," said Zeitgeist. "See there?" He pointed with one hand, and with the other reached for a button on the bench and pressed it. A little metal arm snapped up against the tape just where it passed over an idler. "That punched a little hole in the tape. Not enough

to affect the recording." Zeitgeist turned the reel slowly by hand, moving the tape along an inch or so. Joe saw, on the moving tape, a tiny bright spot of light. When the almost invisible hole moved into it, the red light flared. "I pushed that button every time you said 'I mean.' Let's play it again."

He played it again, and Joe listened—an act of courage, because with all his heart he wanted to cover his ears, shut his eyes against that red blaze. He was consumed with embarrassment. He had never heard anything that sounded so completely idiotic. When at last it was over, Zeitgeist grinned at him. "Learn something?"

"I did," said Joe devoutly.

"O.K.," said Zeitgeist, in a tone which disposed of the matter completely as far as he was concerned, at the same time acting as prelude to something new. The man's expressiveness was extraordinary; with a single word he had Joe's gratitude and his fullest attention. "Now listen to this." He made some adjustments, threw a switch. Joe's taped voice said, ". . . go back and check it with Ba-a-a-a-a-a—" with the "ah" going on and on like an all-clear signal. "That bother you?" called Zeitgeist over the noise.

"It's awful!" shouted Joe. This time he did cover his ears. It didn't help. Zeitgeist switched off the noise and laughed at him. "That's understandable. Your own voice, and it goes on and on like that. What's bothering you is, it doesn't breathe.

I swear you could choke a man half to death, just by making him listen to that. Well, don't let it worry you. That thing over there"—he pointed to a massive cabinet against the wall—"is my analyzer. It breaks up your voice into all the tones and overtones it contains, finds out the energy-level of each, and shoots the information to that tone-generator yonder. The generator reproduces each component exactly as received, through seventy-two band-pass filters two hundred cycles apart. All of which means that when I tell it to, it picks out a single vowel sound—in this case your 'a' in 'Barnes'—and hangs it up there on the 'scope like a photograph for as long as I want to look at it."

"All that, to do what I do when I say 'ah'?"

"All that," beamed Zeitgeist. Joe could see he was unashamedly proud of his equipment. He leaned forward and flicked Joe across the Adam's apple. "That's a hell of a compact little machine, that pharynx of yours. Just look at that wave-form."

Joe looked at the screen. "Some mess."

"A little tomato sauce and you could serve it in an Italian restaurant," said Zeitgeist. "Now let's take it apart."

From another bench he carried the cable of a large control box, and plugged it into the analyzer with a many-pronged jack. The box had on it nearly a hundred keys. He fingered a control at the end of each row and

the oscilloscope subsided to its single straight line. "Each one of these keys controls one of those narrow two-hundred-cycle bands I was talking about," he told Joe. "Your voice—everybody's voice—has high and low overtones, some loud, some soft. Here's one at the top, one in the middle, one at the bottom." He pressed three widely separated keys. The speaker uttered a faint breathy note, then a flat tone, the same in pitch but totally different in quality; it was a little like hearing the same note played first on a piccolo and then on a viola. The third key produced only a murmuring hiss, hardly louder than the noise of the amplifier itself. With each note, the 'scope showed a single wavy line. With the high it was a steep but even squiggle. In the middle it was a series of shallow waves like a child's drawing of an ocean. Down at the bottom it just shook itself and lay there.

"Just what I thought. I'm not saying you're a soprano, Joe, but there's five times more energy in your high register than there is at the bottom. Ever hear the way a kid's voice climbs the scale when he's upset—whining, crying, demanding? 'Spose I told you that all the protest against life that you're afraid to express in anger, is showing up here?" He slid his fingers across the entire upper register, and the speaker bleated. "Listen to that, the poor little feller."

In abysmal self-hatred, Joe felt the

sting of tears. "Cut it out," he blurted.

"Caht eet ow-oot," mimicked Zeitgeist. Joe thought he'd kill him, then and there, but couldn't because he found himself laughing. The imitation was very good. "You know, Joe, the one thing you kept droning on about in the other room was something about 'they won't listen to me. Nobody will listen.' How many times, say, in the office, have you had a really solid idea and kept it to yourself because 'nobody will listen'? How many times have you wanted to do something with your wife, go somewhere, ask her to get something from the cleaners—and then decided not to because she wouldn't listen?" He glanced around at Joe, and charitably turned away from the contorted face. "Don't answer that: you know, and it doesn't matter to me.

"Now get this, Joe. There's something in all animals just about as basic as hunger. It's the urge to attack something that's retreating, and its converse: to be wary of something that won't retreat. Next time a dog comes running up to you, growling, with his ears laid back, turn and run and see if he doesn't take a flank steak out of your southern hemisphere. After you get out of the hospital, go back and when he rushes you, laugh at him and keep going on about your business, and see him decide you're not on his calorie chart for the day. Well, the same thing works with people. No one's going to attack you unless he

has you figured out—especially if he figures you'll retreat. Walk around with a big neon sign on your head that says HEY EVERYBODY I WILL RETREAT, and you're just going to get clobbered wherever you go. You've got a sign like that and it lights up every time you open your mouth. Caht eet owoot."

Joe's lower lip protruded childishly. "I can't help what kind of voice I've got."

"Probably you can't. I can, though."

"But how—"

"Shut up." Zeitgeist returned all the keys to a neutral position and listened a moment to the blaring audio. Then he switched it off and began flicking keys, some up, some down. "Mind you, this isn't a matter of changing a tenor into a baritone. New York City once had a mayor with a voice like a Punch and Judy show, and he hadn't an ounce of retreat in him. All I'm going to do is cure a symptom. Some people say that doesn't work, but ask the gimpy guy who finds himself three inches taller and walking like other people, the first time he tries his built-up shoes. Ask the guy who wears a well-made toupee." He stared for a while at the 'scope, and moved some more keys. "You want people to listen to you. All right, they will, whether they want to or not. Of course, *what* they listen to is something else again. It better be something that backs up this voice I'm giving you. That's up to you."

"I don't under—"

"You'll understand a lot quicker if we fix it so you listen and I talk. O.K.?" Zeitgeist demanded truculently, and sent over such an engaging grin that the words did not smart. "Now, like I said, I'm only curing a symptom. What you have to get through your thick head is that the disease doesn't exist. All that stuff about your sister Anna, and Joey, that doesn't exist because it happened and it's finished and it's years ago and doesn't matter any more. Lutie, Barnes . . . well, they bother you mostly because they won't listen to you. *They'll listen to you now.* So that botherment is over with, too; finished, done with, non-existent. For all practical purposes yesterday is as far beyond recall as twenty years ago; just as finished, just as dead. So the little boy who got punished by his big sister until he thought he deserved being punished—*he* doesn't exist. The man with the guilty feeling killing a kid called Joey, he doesn't exist either any more, and by the way he wasn't guilty in the first place. The copy man who lets a pipsqueak sadist prick him with petty sarcasms—he's gone too, because now there's a man who won't swallow what he wants to say, what he knows is right. He'll say it, just because *people will listen.* A beer stein is pretty useless to anyone until you put beer in it. The gadget I'm going to give you won't do you a bit of good unless you put yourself, your real self into it." He had finished with the keys while he

WON'T YOU WALK—

spoke, had turned and was holding Joe absolutely paralyzed with his strange light eyes.

Inanely, Joe said, "G-gadget?"

"Listen." Zeitgeist hit the master switch and Joe's voice again came from the speaker. "We only advertise in trade magazines. The engineer'll come to me with something he wants to promote and—"

And the voice was his voice, but it was something else, too. Its pitch was the same, inflection, accent; but there was a forceful resonance in it somewhere, somehow. It was a compelling voice, a rich voice; above all it was assertive and sure. (And when the 'I means' came, and the scalding light flashed, it wasn't laughable or embarrassing; it was simply unnecessary.)

"That isn't me."

"You're quite right. It isn't. But it's the way the world will hear you. It's behind the way the world will treat you. And the way the world treats a man is the way the man grows, if he wants to and he's got any growing left in him. Whatever is in that voice you can *be* because I will help and the world will help. But you've got to help, too."

"I'll help," Joe whispered.

"Sometimes I make speeches," said Zeitgeist, and grinned shyly. The next second he was deeply immersed in work.

He drew out a piece of paper with mimeographed rulings on it, and here and there in the ruled squares he jotted down symbols, referring

to the keyboard in front of him. He seemed then to be totaling columns; once he reset two or three keys, turned on the audio and listened intently, then erased figures and put down others. At last he nodded approvingly, rose, stretched till his spine cracked, picked up the paper and went over to the third bench.

From drawers and cubbyholes he withdrew components — springs, pads, plugs, rods. He moved with precision and swift familiarity. He rolled out what looked like a file drawer, but instead of papers it contained ranks and rows of black plastic elements, about the size and shape of miniature match boxes, each with two bright brass contacts at top and bottom.

"We're living in a wonderful age, Joe," said Zeitgeist as he worked. "Before long I'll turn the old soldering iron out to stud and let it father waffles. Printed circuits, sub-mini tubes, transistors. These things here are electrets, which I won't attempt to explain to you." He bolted and clipped, bent and formed, and every once in a while, referring to his list, he selected another of the black boxes from the file and added it to his project. When there were four rows of components, each row about one and a half by six inches, he made some connections with test clips and thrust a jack into a receptacle in the bench. He glanced up at the 'scope, grunted, unclipped one of the black rectangles and substituted another from the files.

"These days, Joe, when they can

pack a whole radar set—transmitter, receiver, timing and arming mechanisms and a power supply into the nose of a shell, a package no bigger than your fist—these days you can do anything with a machine. Anything, Joe. You just have to figure out how. Most of the parts exist, they make 'em in job lots. You just have to plug 'em together." He plugged in the jack, as if to demonstrate, and glanced up at the 'scope. "Good. The rest won't take long." Working with tin-snips, then with a small sheet-metal brake, he said, "Some day you're going to ask me what I'm doing, what all this is for, and I'll just grin at you. I'm going to tell you now and if you don't remember what I say, well, then forget it.

"They say our technology has surpassed, or bypassed, our souls, Joe. They say if we don't turn from science to the spirit, we're doomed. I agree that we're uncomfortably close to damnation, but I don't think we'll appease any great powers by throwing our gears and gimmicks over the cliff as a sacrifice, a propitiation. Science didn't get us into this mess; we *used* science to get us in.

"So I'm just a guy who's convinced we can use science to get us out. In other words, I'm not for hanging the gunsmith every time someone gets shot. Take off your shirt."

"What?" said Joe, back from a thousand miles. "Oh." Bemused, he took off his jacket and shirt and stood shyly clutching his thin ribs.

Zeitgeist picked up his project

from the bench and put it over Joe's head. A flat band of spring steel passed over each shoulder, snugly. The four long flat casings, each filled with components, rested against his collarbones, pressing upward in the small hollow just below the bones, and against his shoulder blades. Zeitgeist bent and manipulated the bands until they were tight but comfortable. Then he hooked the back pieces to the front pieces with soft strong elastic bands passing under Joe's arms. "O.K.? O.K. Now—say something."

"Say what?" said Joe stupidly, and immediately clapped his hand to his chest. "*Ub!*"

"What happened?"

"It . . . I mean, it buzzed!"

Zeitgeist laughed. "Let me tell you what you've got there. In front, two little speakers, an amplifier to drive them, and a contact microphone that picks up your chest tones. In back, on this side, a band-pass arrangement that suppresses all those dominating high-frequency whimperings of yours and feeds the rest, the stuff you're weak in, up front to be amplified. And over here, in back—that's where the power supply goes. Go over there where you were and record something. And remember what I told you—you have to help this thing. Talk a little slower and you won't have to say 'I mean' while you think of what comes next. You *know* what comes next, anyway. You don't have to be afraid to say it."

Dazed, Joe stepped back to where he had been when the first recording

was made, glanced for help up at the green line of the oscilloscope, closed his eyes and said, falteringly at first, then stronger and steadier, "'Four score and seven years ago, our fathers brought forth upon this continent—'"

"Cut!" cried Zeitgeist. "Joe, see that tone-generator over there? It's big as a spinet piano. I can do a lot but believe me, you haven't got one of those strapped on you. Your amplifier can only blow up what it gets. You don't have much, but for Pete's sake give it what you have. Try talking with your lungs full instead of empty. Push your voice a little, don't just let it fall out of you."

"Nothing happens, though. I sound the same to myself. Is it working? Maybe it doesn't work."

"Like I told you before," said Zeitgeist with exaggerated patience, "people who are talking aren't listening. It's working all right. Don't go looking for failures, Joe. Plenty'll come along that you didn't ask for. Now go ahead and do as I said."

Joe wet his lips, took a deep breath. Zeitgeist barked, "Now slowly!" and he began: "'Four score and seven years—'" The sonorous words rolled out, his chest vibrated from the buzzing, synchronized to his syllables. And though he was almost totally immersed in his performance, a part of him leaped excitedly, realizing that never in his whole life before had he listened, really listened to that majestic language. When he was finished he opened his eyes and found Zeitgeist

standing very near him, his eyes alight.

"Good," the man breathed. "Ah, but . . . good."

"Was it? Was it really?"

In answer, Zeitgeist went to the controls, rewound the tape, and hit the playback button.

And afterwards, he said gently to Joe, "You *can* cry—see?"

"Damn foolishness," said Joe.

"No it isn't," Zeitgeist told him.

Outside, it was morning—what a morning, with all the gold and green, thrust and rustle of a new morning in a new summer. He hadn't been out all night; he had died and was born again! He stood tall, walked tall, he carried his shining new voice sheathed like Excalibur, but for all its concealment, he was armed!

He had tried to thank Zeitgeist, and that strange man had shaken his head soberly and said, "Don't, Joe. You're going to pay me for it."

"Well I will, of course I will! Anything you say . . . how much, anyhow?"

Zeitgeist had shaken his head slightly. "We'll talk about it later. Go on—get in the car. I'll drive you to work." And, silently, he had.

Downtown, he reached across Joe and opened the door. For him, the door worked. "Come see me day after tomorrow. After dinner—nine."

"O.K. Why? Got another . . . treatment?"

"Not for you," said Zeitgeist, and

his smile made it a fine compliment for both of them. "But no power plant lasts forever. Luck." And before Joe could answer the door was closed and the big car had swung out into traffic. Joe watched it go, grinning and shaking his head.

The corner clock said five minutes to nine. Just time, if he hurried.

He didn't hurry. He went to Harry's and got shaved, while they pressed his suit and sponged his collar in the back room. He kept the bathrobe they gave him pulled snugly over his amplifier, and under a hot towel he reached almost the euphoric state he had been in last night. He thought of Barnes, and the anger stirred in him. With some new internal motion he peeled away its skin of fear and set it free. Nothing happened, except that it lived in him instead of just lying there. It didn't make him tremble. It made him smile.

Clean, pressed and smelling sweet, he walked into his building at eight minutes before ten. He went down to the express elevator and stepped into the one open door. Then he said, "Wait," and stepped out again. The operator goggled at him.

Joe walked up to the starter, a bushy character in faded brown and raveled gold braid. "Hey . . . you."

The starter pursed a pair of liver-colored lips and glowered at him. "Whaddayeh want?"

Joe filled his lungs and said evenly, "Day before yesterday you took hold of me and shoved me into an elevator like I was a burlap sack."



The starter's eyes flickered. "Not me."

"You calling me a liar, too?"

Suddenly the man's defenses caved. There was a swift pucker which came and went on his chin, and he said, "Look, I got a job to do, mister, rush hours, if I don't get these cars out of here it's *my* neck, I didn't mean nothing by it, I—"

"Don't tell me your troubles," said Joe. He glared at the man for a second. "All right, do your job, but don't do it on me like that again."

He turned his back, knowing he was mimicking Zeitgeist with the gesture and enjoying the knowledge. He went back to the elevator and got in. Through the closing gate he saw the starter, right where he had left him, gaping. The kid running the elevator was gaping, too.

"Eleven," said Joe.

"Yes, *sir*," said the boy. He started the car. "You told *him*."

"Bout time," said Joe modestly.

"Past time," said the kid.

Joe got out on the eleventh floor, feeling wonderful. He walked down the hall, thumped a door open, and ambled in. Eleanor Bulmer, the receptionist, looked up. He saw her eyes flick to the clock and back to his face. "Well!"

"Morning," he said expansively, from his inflated lungs. She blinked as if he had fired a cap pistol, then looked confusedly down at her typewriter.

He took a step toward his corner

WON'T YOU WALK—

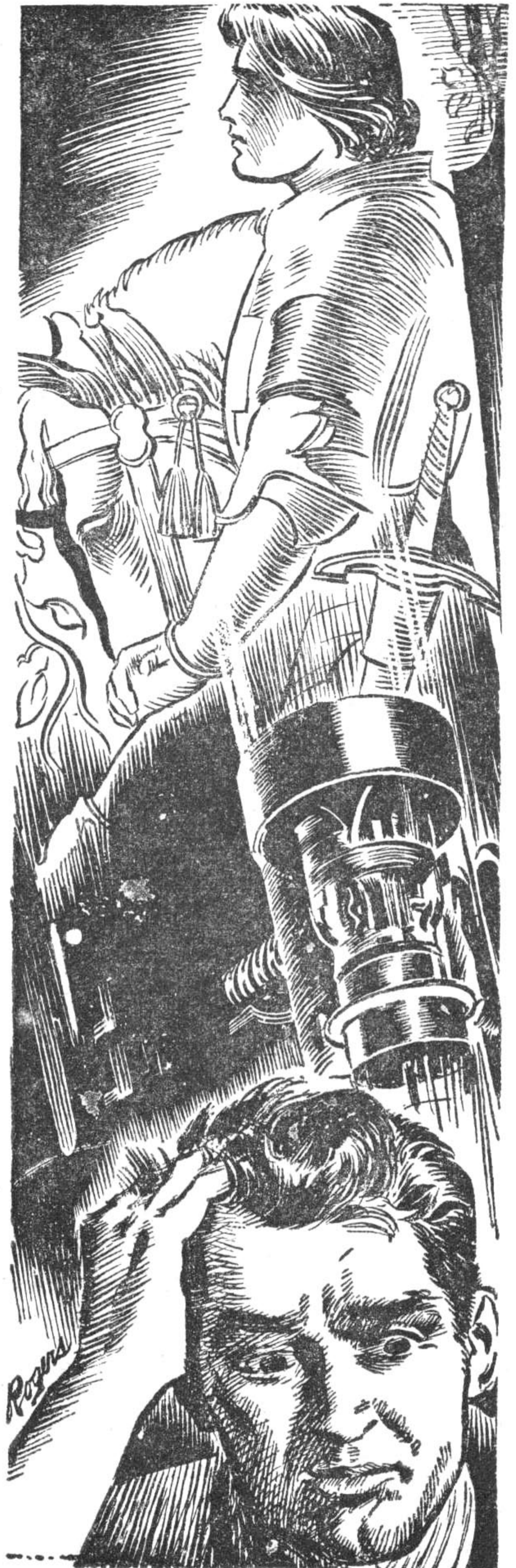

desk when there was a flurry, a botherment up from the left, then an apparition of thinning hair and exophthalmic blue eyes. Barnes, moving at a half-trot as usual, jacket off, suspenders, arm-bands pulling immaculate cuffs high and away from rust-fuzzed scrawny wrists. "Eleanor, get me Apex on the phone. Get me Apex on the—" And then he saw Joe. He stopped. He smiled. He had gleaming pale-yellow incisors like a rodent. He, too, flicked a glance at the clock.

Joe knew exactly what he was going to say, exactly how he was going to say it. He took a deep breath, and if old ghosts were about to rise in him, the friendly pressure of the amplifier just under his collar-bones turned them to mist. *Why, Miss Terr Fritch*, Barnes would say with exaggerated and dramatic politeness, *how ki-i-ind of you to drop in today*. Then the smile would snap off and the long series of not-to-be-answered questions would begin. Didn't he know this was a place of business? Was he aware of the customary starting time? Did it not seem that among fourteen punctual people, he alone—and so on. During it, seven typewriters would stop, a grinning stock boy would stick his head over a filing cabinet to listen, and Miss Bulmer, over whose nape the monologue would stream, would sit with her head bowed waiting for it to pass. Already the typewriters had stopped. And yes, sure enough: behind Barnes he could see the stock boy's head.

"Why, Miss Terr Fritch!" said Barnes happily.

Joe immediately filled his lungs, turned his back on Barnes, and said into the stunned silence, "Better get him Apex on the phone, Eleanor. He has the whole place at a standstill." He then walked around Barnes as if the man were a pillar and went to his desk and sat down.

Barnes stood with his bony head lowered and his shoulders humped as if he had been bitten on the neck by a fire-ant. Slowly he turned and glared up the office. There was an immediate explosion of typewriter noise, shuffling feet, shuffling papers. "I'll take it in my office," Barnes said to the girl.

He had to pass Joe to get there, and to Joe's great delight he could see how reluctant Barnes was to do it. "I'll see you later," Barnes hissed as he went by, and Joe called cheerfully after him, "You just betcha." Out in the office, somebody whistled appreciatively; somebody snickered. Joe knew Barnes had heard it. He smiled, and picked up the phone. "Outside, Eleanor. Personal."

Eleanor Bulmer knew Barnes didn't allow personal calls except in emergencies, and then preferred to give his permission first. Joe could hear her breathing, hesitating. Then, "Yes, Mr. Fritch." And the dial tone crooned in his ear. *Mr. Fritch*, he thought. *That's the first time she ever called me Mr. Fritch. What do you know. Why . . . why, she never called me anything before! Just "Mr. Barnes wants to see you," or "Cohen*

*of Electrical Marketing on the line."*

Mr. Fritch dialed his home. "Hello—Lutie?"

"Joe! Where were you all night?" The voice was waspish, harrying; he could see her gathering her forces, he could see her mountain of complaints about to be shoveled into the telephone as if it were a hopper.

"I called up to tell you I'm all right because I thought it was a good idea. Maybe it was a bad idea."

"What?" There was a pause, and then in quite a different tone she said, "Joe? Is this . . . Joe, is that you?"

"Sure," he said heartily. "I'm at work and I'm all right and I'll be home for dinner. Hungry," he added.

"You expect me to cook you a dinner after—" she began, but without quite her accustomed vigor.

"All right, then I won't be home for dinner," he said reasonably.

She didn't say anything for a long time, but he knew she was still there. He sat and waited. At last she said faintly, "Will veal cutlets be all right?"

On the second night after this fledging, Mr. Joseph Fritch strode into the porte-cochere and bounded up the steps. He ground the bell-push with his thumb until it hurt, and then knocked. He stood very straight until the door opened.

"Joe, boy! Come on in." Zeitgeist left the door and opened another. Joe had the choice of following or of standing where he was and shouting. He followed. He found himself

in a room new to him, low-ceilinged like the others, but with books from floor to ceiling. In a massive field-stone fireplace flames leaped cheerfully, yet the room was quite cool. Air-conditioned. Well, he guessed Zeitgeist just *liked* a fire. "Look," he said abruptly.

"Sit down. Drink?"

"No. Listen, you've made a mistake."

"I know, I know. The bill. Got it with you?"

"I have."

Zeitgeist nodded approvingly. Joe caught himself wondering why. Zeitgeist glided across to him and pressed a tall glass into his hand. It was frosty, beaded, sparkling. "What's in it?" he snapped.

Zeitgeist burst out laughing, and in Joe's fury passed, and shame passed, and he found himself laughing, too. He held out his glass and Zeitgeist clinked with him. "You're a . . . a—Luck."

"Luck," said Zeitgeist. They drank. It was whisky, the old gentle muscular whisky that lines the throat with velvet and instantly heats the ear lobes. "How did you make out?"

Joe drank again and smiled. "I walked into that office almost an hour late," he began, and told what had happened. Then, "And all day it was like that. I didn't know a job . . . people . . . I didn't know things could be like that. Look, I told you I'd pay you. I said I'd pay you anything you—"

"Never mind that just now. What else happened? The suit and all?"

"That. Oh, I guess I was kind of—" Joe looked into the friendly amber in his glass, "well, intoxicated. Lunch time I just walked into King's and got the suit. Two suits. I haven't had a new suit for four years, and then it didn't come from King's. I just signed for 'em," he added, a reflective wonderment creeping into his voice. "They didn't mind. Shirts," he said, closing his eyes.

"It'll pay off."

"It did pay off," said Joe, bouncing on his soft chair to sit upright on the edge, shoulders back, head up. His voice drummed and his eyes were bright. He set his glass down on the carpet and swatted his hands gleefully together. "There was this liaison meeting, they call it, this morning. I don't know what got into me. Well, I do; but anyway, like every other copywriter I have a project tucked away; you know—I like it but maybe no one else will. I had it in my own roughs, up to yesterday. So I got this bee in my bonnet and went in to the Art Department and started in on them, and you know, they caught fire, they worked almost all *night*? And at the meeting this morning, the usual once-a-month kind of thing, the brass from the main office looking over us stepchildren and wondering why they don't fold us up and go to an outside agency. It was so easy!" he chortled.

"I just sat there, shy like always, and there was old Barnes as usual trying to head off product advertising and go into institutionals, because he likes to write that stuff himself.

thinks it makes the brass think he loves the company. So soon as he said 'institutionals' I jumped up and agreed with him and said let me show you one of Mr. Barnes' ideas. Yeah! I went and got it and you should *see* that presentation; you could eat it! So here's two VP's and a board secretary with their eyes bugging out and old Barnes not daring to deny anything, and everybody in the place knew I was lying and thought what a nice fellow I was to do it that way. And there sat that brass, looking at my haircut and my tie and my suit and me, and *buying* it piece by piece, and Barnes, old Barnes sweating it out."

"What did they offer you?"

"They haven't exactly. I'm supposed to go see the chairman Monday."

"What are you going to do?"

"Say no. Whatever it is, I'll say no. I have lots of ideas piled up—nobody would *listen* before! Word'll get around soon enough; I'll get my big raise the only smart way a man can get a really big one—just before he goes to work for a new company. Meanwhile I'll stay and work hard and be nice to Barnes, who'll die a thousand deaths."

Zeitgeist chuckled. "You're a stinker. What happened when you went home?"

Joe sank back into his chair and turned toward the flames; whatever his thoughts were, they suffused him with firelight and old amber, strength through curing, through waiting. His voice was just that mellow as he

murmured, "That wasn't you at all. That was me."

"Oh, sorry. I wasn't prying."

"Don't get me wrong!" said Joe. "I want to tell you." He laughed softly. "We had veal cutlets."

A log fell and Joe watched the sparks shooting upward while Zeitgeist waited. Suddenly Joe looked across at him with a most peculiar expression on his face. "The one thing I never thought of till the time came. I couldn't wear that thing all night, could I now? I don't want her to know. I'll be . . . you said I'd grow to . . . that if I put my back into it, maybe some day I wouldn't need it." He touched his collarbone.

"That's right," said Zeitgeist.

"So I couldn't wear it. And then I couldn't talk. Not a word." Again, the soft laugh. "She wouldn't sleep, not for the longest time. 'Joe?' she'd say, and I'd know she was going to ask where I'd been that night. I'd say, 'Shh.' and put my hand on her face. She'd hold on to it. Funny. Funny, how you know the difference," he said in a near whisper, looking at the fire again. "She said, 'Joe?' just like before, and I knew she was going to say she was sorry for being . . . well, all the trouble we've had. But I said 'Shh.'" He watched the fire silently, and Zeitgeist seemed to know that he was finished.

"I'm glad," said Zeitgeist.

"Yeah."

They shared some quiet. Then

Zeitgeist said, waving his glass at the mantel, "Still think the bill's out of line?"

Joe looked at it, at the man. "It's not a question of how much it's worth," he said with some difficulty. "It's how much I can pay. When I left here I wanted to pay you whatever you asked—five dollars or five hundred, I didn't care what I had to sacrifice. But I never thought it would be five *thousand!*" He sat up. "I'll level with you; I don't have that kind of money. I never did have. Maybe I never will have."

"What do you think I fixed you up for?" Zeitgeist's voice cracked like a target-gun. "What do you think I'm in business for? I don't gamble."

Joe stood up slowly. "I guess I just don't understand you," he said coldly. "Well, at those prices I guess I can ask you to service this thing so I can get out of here."

"Sure." Zeitgeist rose and led the way out of the room and down the hall to the laboratory. His face was absolutely expressionless, but not fixed; only relaxed.

Joe shucked out of his jacket, unbuttoned his shirt and took it off. He unclipped the elastics and pulled the amplifier off over his head. Zeitgeist took it and tossed it on the bench. "All right," he said, "get dressed."

Joe went white. "What, you want to haggle? Three thousand then, when I get it," he said shrilly.

Zeitgeist sighed. "Get dressed."

Joe turned and snatched at his

shirt. "Blackmail. Lousy blackmail."

Zeitgeist said, "You know better than that."

There is a quality of permanence about the phrase that precedes a silence. It bridges the gap between speech and speech, hanging in mid-air to be stared at. Joe pulled on his shirt, glaring defiantly at the other man. He buttoned it up, he tucked in the tails, he put on his tie and knotted it, and replaced his tie-clasp. He picked up his coat. And all the while the words hung there.

He said, miserably, "I want to know better than that."

Zeitgeist's breath hissed out; Joe wondered how long he had been holding it. "Come here, Joe," he said gently.

Joe went to the bench. Zeitgeist pulled the amplifier front and center. "Remember what I told you about this thing—a mike here to pick up the chest tones, band-passes to cut down on what you have too much of, and the amplifier here to blow up those low resonances? And this?" he pointed.

"The power supply."

"The power supply," Zeitgeist nodded. "Well, look; there's nothing wrong with the theory. Some day someone will design a rig this compact that will do the job, and it'll work just as I said." His pale gaze flicked across Joe's perplexed face and he laughed. "You're sort of impressed with all this, aren't you?" He indicated the whole lab and its contents.

"Who wouldn't be?"

"That's the mythos of science, Joe. The layman is as willing to believe in the super-powers of science as he once did in witches. Now, I told you once that I believe in the ability of science to save our souls . . . our *selves*, if you like that any better. I believe that it's legitimate to use any and all parts of science for this purpose. And I believe the mythos of science is as much one of its parts as Avogadro's Law or the conservation of energy. Any layman who's seen the size of a modern hearing-aid, who knows what it can do, will accept with ease the idea of a band-passing amplifier with five watts output powered by a couple of pen-lite cells. Well, we just can't do it. We will, but we haven't yet."

"Then what's this thing? What's all this gobbledegook you've been feeding me? You give me something, you take it away. You make it work, you tell me it can't work. I mean, what are you trying to pull?"

"You're squeaking. And you're saying 'I mean,' " said Zeitgeist.

"Cut it out," Joe said desperately.

The pale eyes twinkled at him, but Zeitgeist made a large effort and went back to his subject. "All this is, this thing you've been wearing, is the mike here, which triggers these two diaphragm vibrators here, powered by these little dry cells. No amplifier, no speakers, no nothing but this junk and the mythos."

"But it worked; I heard it **right** here on your tape machine!"

"With the help of half a ton of components."

"But at the office, the liaison meeting, I . . . I— Oh—"

"For the first time in your life you walked around with your chest out. You faced people with your shoulders back and you looked 'em smack in the eye. You dredged up what resonance you had in that flattened-out chest of yours and flung it in people's faces. I didn't lie to you when I said they *had* to listen to you. They had to as long as you believed they had to."

"Did you have to drag out all this junk to make me believe that?"

"I most certainly did! Just picture it: you come to me here all covered with bruises and guilt, suicidal, cowed, and without any realizable ambition. I tell you all you need to do is stand up straight and spit in their eye. How much good would that have done you?"

Joe laughed shakily. "I feel like one of those characters in the old animated cartoons. They'd walk off the edge of a cliff and hang there in midair, and there they'd stay, grinning and twirling their canes, until they looked down. Then—

boom!" He tried another laugh, and failed with it. "I just looked down," he said hoarsely.

"You've got it a little backwards," said Zeitgeist. "Remember how you looked forward to graduating—to the time when you could discard that monkey-puzzle and stand on your own feet? Well, son, you just made it. Come on; this calls for a drink!"

Joe jammed his arms into his jacket. "Thanks, but I just found out I can talk to my wife."

They started up the hall. "What do you do this for, Zeitgeist?"

"It's a living."

"Is that streamlined mousetrap out there the only bait you use?"

Zeitgeist smiled and shook his head.

For the second time in fifteen minutes Joe said, "I guess I just don't understand you," but there was a world of difference. Suddenly he broke away from the older man and went into the room with the fireplace. He came back, jamming the envelope into his pocket. "I can handle this," he said. He went out.

Zeitgeist leaned in the doorway, watching him go. He'd have offered him a ride, but he wanted to see him walk like that, with his head up.



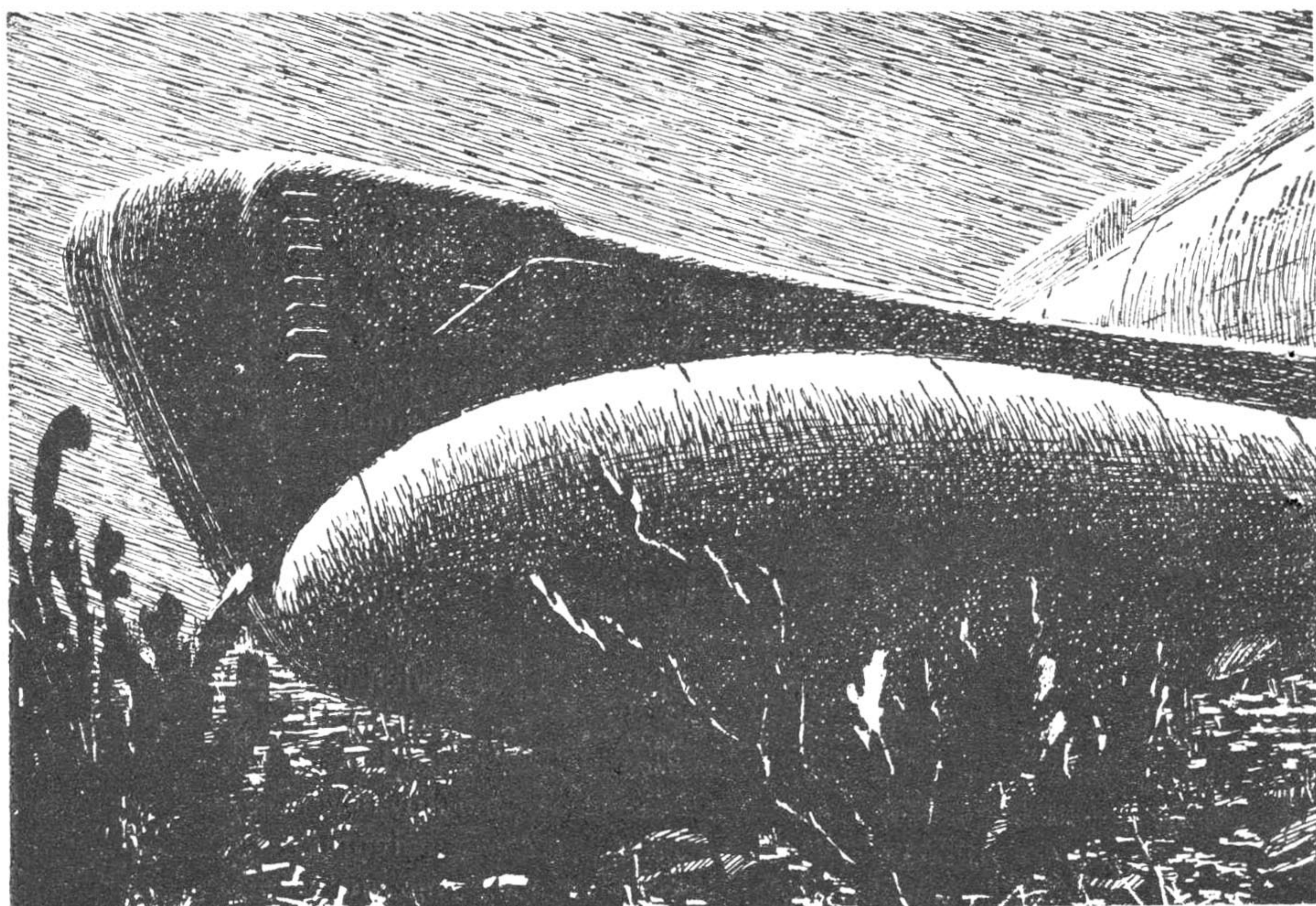

## SYNOPSIS

# UNDER PRESSURE

**Conclusion.** *There was a factor present that held the men together under that grinding, unendurable pressure . . . that wouldn't fit into the psychodynamic equations. Essentially, they weren't machines, and the dynamics of machines didn't apply!*

**BY FRANK HERBERT**

Illustrated by van Dongen

*The sub tug Fenian Ram is on a desperate wartime mission to steal oil from a secret well underwater on the enemy's continental shelf. Operating in the terrible pressures of the ocean deeps exposes the hidden weaknesses of the four crewmen:*

Commander Sparrow, skipper of the submarine, a deeply religious man whose emotions are held in iron control.

Lieutenant Commander Leslie Bonnett, a man of brooding moods and occasional flippancy whose feeling for Sparrow is near worship.

Lieutenant José Garcia, engineering officer, a suspected spy who gives

**ASTOUNDING SCIENCE FICTION**



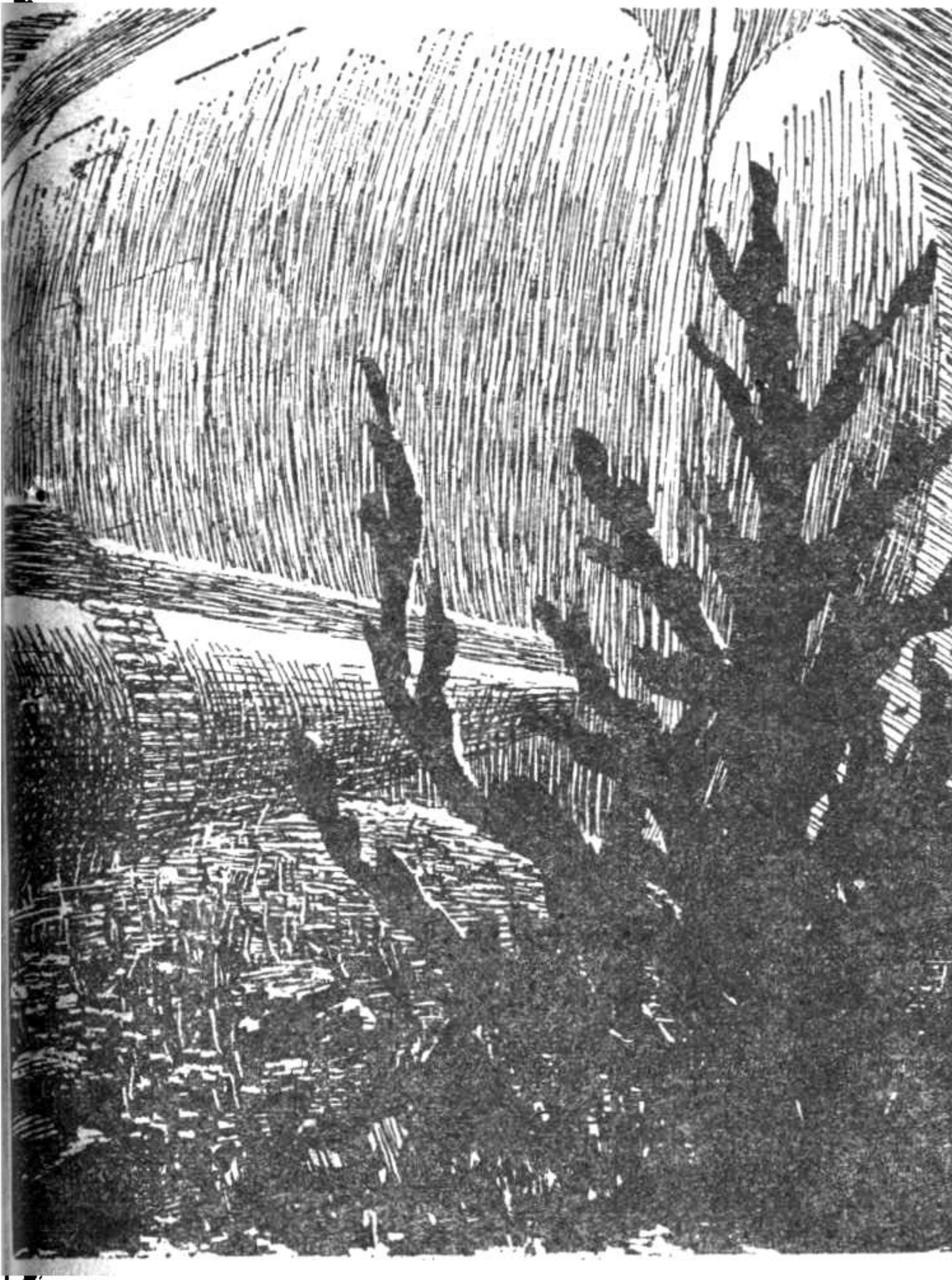

indications that he is aware of the secret position held in the crew by—

Ensign John Ramsey, a Bu-Psych electronics expert sent aboard the sub tug with the hidden mission of keeping the captain and crew in psychological balance.

As evidence mounts that one of the Ram's crewmen is a saboteur, the sub tug creeps closer to its destination in the Arctic and into an ocean no man's land swarming with packs of enemy submarines. The Ram engages one pack, sinks two submarines, escapes by floating silently to the surface.

Wave turbulence at the surface, coming after the wracking explosions of the undersea battle, causes damage in the atomic pile room.

Sparrow repairs the damage but suffers a radiation overdose. He is under treatment in sick bay when the Ram is trapped by another pack. This time they escape in a desperate maneuver suggested by Ramsey: diving far below their depth limit, a feat made possible by increased pressure inside the submarine.

Garcia gets oxygen-drunk under the increased pressure, reveals that he knows Ramsey is a Bu-Psych operative. Ramsey fears that Garcia will tell Sparrow.

Sparrow has ordered that two men be on duty at all times to watch each other and this brings further tensions. He fears that a saboteur aboard may reveal the location of the well.

Ramsey, seeing the psychological elements getting out of hand, deliberately attracts suspicion to himself. He wants to arouse anger in Sparrow, hoping that this will effect an emotional catharsis.

Meanwhile, the Ram has been detected by the enemy almost at the secret well. They escape by hiding in a deep underwater canyon, then fleeing across shallows when the pursuers dive into the canyon. Acting on Sparrow's orders, Ramsey and Garcia go outside in lung suits, rig torpedoes to fake the sound of the sub tug's screw. The torpedoes are sent off to fool their pursuers. Enemy submarines destroy the dummy torpedoes in the belief the torpedoes are the Ram. Then the enemy pack leaves.

The Ram goes on to the well.

*But now Ramsey believes he has discovered how the spybeams were activated and he sees an immediate and deadly danger to their mission. As he is in the electronics shack alone, testing his theory, Bonnett enters. Bonnett's suspicions have been aroused by Ramsey's recent actions. The first officer believes that Ramsey is a spy about to signal the well's location. Bonnett leaps at Ramsey, beats the Bu-Psych operative into unconsciousness.*

### PART 3

Voices.

They came to Ramsey from somewhere at the top of a long black hole. He tried to ignore them, moved his head. Pain shot through him.

"I think he's coming around."  
Garcia.

"Here, make him drink this."  
Sparrow.

"Why waste it?" Bonnett.

"I'm not satisfied that you're correct." Sparrow.

"I tell you, skipper, I saw him putting that spybeam tube into a socket and—"

"How do you know it was a spybeam? One of you stepped on it and crushed it during that fracas."

"It looked suspicious, skipper."

"Looked . . . schmooked." Garcia.

Hand under his neck. Something acrid and biting in his mouth, burning in his throat.

Choking, coughing.

Ramsey gagged, retched.

Again the liquid was forced past

his lips. He shuddered, managed to keep it down. His body felt like one large ache.

"Can you talk, Johnny?" Sparrow.

Ramsey opened his eyes. Sparrow bent over him, supporting his shoulders.

Bonnett and Garcia stood beyond.

Ramsey's eyes focused on the rest of his surroundings: rec room, cot, table and first-aid kit.

Back to Bonnett and Garcia.

Bonnett glowering, perhaps a bit uncertain.

Garcia faintly worried.

Ramsey groped toward his jaw with one hand, felt a lance of fire shoot through his head. "I c'n talk a li'l," he said.

Sparrow brought some pillows up behind Ramsey, eased him back onto them. "What were you doing in the shack?"

The tube! Spybeam!

Ramsey forced the words past his thickened lips. "Think I found out how spybeam triggered."

Sudden interest in the eyes of Sparrow and Garcia. More uncertainty in Bonnett's expression.

"By someone on board?" asked Sparrow.

"No. This's urgen', skipper. Don' raise th' peribox."

"Why?"

"Piping in a signal."

"The air's full of stuff. What—"

"This's special. You gave me idea." Ramsey passed his tongue over his thickened lips, forced himself to speak clearly. "Go' to un'erstan' me," he said. "Resonance. EPs

are sending out a harmonic on th' plate frequency of our L-4 tubes. Eventually, it breaks 'em down so they become microphonic. Th' tubes we found were just amplifiers. Spy-beam actually comes from th' L-4s."

"But if we've taken out all the amplifiers—"

"Enough L-4s sending and they'd interact in feedback," said Garcia. "Wouldn't need an amplifier. They'd set up a howl that could be heard anywhere."

"Why the peribox?" asked Sparrow. Then he said, "Of course: they have to get a clear strong signal into us and the peribox is the only road that isn't damped by a plasteel hull." He shook his head. "Granting that you're telling the truth and that this is so, how can—"

"Rig a substitute for the L-4s," said Garcia. "That's the weak spot in the system."

"That's what I was testing when Les jumped me," said Ramsey.

Bonnett scowled. "This could be a trick, skipper."

Garcia said, "Can it, Les!"

"Dammit all!" shouted Bonnett. "Yesterday you were both telling me how suspicious—"

"We'll discuss it another time," said Sparrow. He turned to Garcia. "What do you think, Joe?"

"It sounds right, skipper." Garcia held up a hand, ticked off items on his fingers. "It has the advantage of simplicity: all they'd have to know is the plate-frequency factor of a suitable tube and they could

channel all their efforts toward breaking down that one unit. If the actual signal originates with them and is merely rebroadcast from our system, they'd have the essential elements of a sonoran system: pinpoint accuracy in locating us. And what would be harder to detect? Their broadcast would be a constant sound in the ether; so every time we raised our peribox, our board filters would automatically cut out that signal as non-dangerous and we wouldn't be listening at all on the wave length that would be likely to give us away!"

Even Bonnett was nodding in agreement as Garcia finished.

Garcia looked at Ramsey. "Is that the way you had it figured?"

"Yes."

"I could probably figure out a substitute system to eliminate the L-4s," said Garcia, "but you're the electronics expert. How?"

"Schematic on shack workbench," said Ramsey.

"Les, check that," ordered Sparrow. "If it's true, it's one more item to confirm his story."

Bonnett went out the door.

Ramsey shut his eyes, tried to slide off the pillows and stretch out flat on the cot.

"Better not," said Sparrow. He held Ramsey upright. "Joe, steady him here a moment while I look at that nose."

Garcia held Ramsey's shoulders.

Sparrow touched Ramsey's nose gently.

"Ouch!" Ramsey jerked back.

"Doesn't appear to be broken," said Sparrow. He reached out, put a thumb on Ramsey's left eyelid, held up the lid while he flashed a handlight into the eye. "Maybe a slight concussion."

"How long was I out?" asked Ramsey.

"About an hour," said Sparrow. "You—"

Bonnett entered carrying a grease-stained sheet of notepaper. He passed the paper to Garcia, who removed one hand from Ramsey's shoulder to take the paper.

"What do you say, Joe?" asked Sparrow.

Garcia studied the paper silently, nodded once, passed it to Sparrow. "A clever adaptation. Simple. It'll work and it uses a tube with a different plate-frequency."

"What does this mean?" asked Bonnett.

"It means you batted out, old chap," said Garcia. "In the vernacular, you goofed."

Bonnett's voice was dangerously low. "Is that so?"

"As a matter of honest fact, we've all goofed," said Garcia. "You were—in the language of the psych chaps—the overt instrument of our dereliction."

Bonnett looked down at Ramsey. "If I made a mistake, I apologize." He glanced at Sparrow, who was still studying Ramsey's schematic diagram. "But I reserve the right to my own opinion."

Sparrow straightened from beside

Ramsey's bunk, looked at Garcia. "Keep him awake for a couple of hours, Joe." He turned away. "Come along, Les. We've a slug to fill and some tube-jockeying. No time to waste."

"Do you want me to do the electronics work?" asked Garcia.

"You stick with him," said Sparrow. He paused in the doorway, stared speculatively at Ramsey, turned and left, followed by Bonnett.

"Do you think they could break down those L-4s without piping through the peribox?" asked Garcia.

"In time," said Ramsey. "But they'd have to increase signal strength by several factors to get a return signal unamplified unless our box were on the surface."

"Clever devils," muttered Garcia. "How'd you spot it?"

"Skipper gave me the idea with his scheme for faking the sound of our screw."

"Got you thinking about resonance," said Garcia.

"About building signals with harmonics," corrected Ramsey.

"Same thing." Garcia came around in front of Ramsey. "Boy, he really worked you over."

"I guess he did."

"Your own fault, though."

Ramsey jerked his head up to stare at Garcia, winced at the sudden motion. "Why do you say that?"

"For some reason, you've delib-

erately set out to make the skipper suspicious of you. But you forgot one thing: suspicion is contagious."

"The pressure's cooking your brains," said Ramsey.

"I wish I knew what you were trying to prove," said Garcia. "Maybe you're trying to beach the skipper."

"Nuts! You have too much imagination."

"We're alike there, Johnny. And time drags in a subtug. There's time for a good imagination to run wild." He stared at the bulkhead a moment. "That's the skipper's problem, too, really."

"That's a rare piece of insight," said Ramsey.

Garcia acted as though he had not heard. "Imagination is a weakness when too much responsibility hangs on your shoulders."

They felt the *Ram* move, stop.

"We're seating the pump onto that well cap," said Garcia. "It'll take us a couple of days to fill the slug, then home we go."

"If it were only that easy," said Ramsey.

Garcia turned, strode across to the rec room bookshelf, found a book, searched in it for a moment and brought it back to Ramsey. "I think you'd better read this, Johnny. It's Savvy Sparrow's favorite passage."

He handed Ramsey a bible, pointing to the beginning of a chapter, said, "Isaiah, twenty-seven, one and two."

Ramsey read it through silently, then reread it aloud:

"In that day the Lord with His sore and great and strong sword shall punish leviathan the piercing serpent, even leviathan that crooked serpent; and He shall slay the dragon that is in the sea."

Garcia continued the quotation from memory:

"In that day sing ye unto her, a vineyard of red wine."

Ramsey stared at the passage, shook his head. "What's it mean to him?"

Garcia said, "'And He shall slay the dragon that is in the sea.'" He reached down, took back the bible. "To Savvy Sparrow, we're the dragon in the sea."

"Here, let me have that," said Ramsey. He took back the bible. "Think I'll read for a while."

"Look out, or you'll get religion," said Garcia.

"No chance," said Ramsey. "My teachers always said if you want to understand a subject, study the basic source. This is it for our captain."

"For a great many people," said Garcia softly. "And a psychologist who does not have an intimate knowledge of that book is a doctor without instruments. And blind, to boot."

Ramsey looked at Garcia over the top of the book. "When are you going to give up that line?"

"When you wake up," said Garcia.

Ramsey hid a frown behind the bible, opened it again to the passage Garcia had pointed out, soon lost himself in the fury of Isaiah, the

woe of Hezekiah and the thundering messages of prophecy.

In the cold Arctic waters outside the *Ram*, pumps turned, hose nozzles sought out bottom muck for ballast. The plastic slug began to swell with its cargo of oil—like a live thing drinking at a jugular in the earth.

The hands of the timelog swept around, around. Fifty-one hours at the well.

Full slug. It stretched out on the bottom behind the *Ram*, turgid with its cargo, almost a mile long, held in delicate hydrostatic balance so that it would tow beneath the surface.

Ramsey and Garcia entered the control room together. Sparrow and Bonnett already were there.

Garcia nodded at something Ramsey had said. "You're right. We'd better—"

"Right about what?" asked Sparrow.

"Johnny was just saying that the slug's compensator system would drop ballast if we try to pull that deep-dive maneuver on the way home."

"He's right," said Sparrow. "And if we don't compensate, we'll rupture the slug."

"And bleed oil all over the surface," said Bonnett. "Wouldn't that be lovely now."

"There might be a way to pull it off," said Sparrow. "But let's hope we don't have to try it." He turned to the control board. "Les, lift us

off. Minimum headway. Take us right down into the gut. We're going to use it for cover as long as we're able."

"Aye." Bonnett's hands moved over the controls.

"Wouldn't they be likely to lay for us in a place like that?" asked Ramsey.

"We're dead, remember?" said Garcia.

Sparrow said, "Joe, take over auxiliary search and keep us down the center of that canyon. Johnny, get on standard search and watch for enemy pips." He folded his arms in front of him. "The Lord has been kind to us, gentlemen. We're going home."

"A milk run," said Garcia.

"For mad dogs and Englishmen," said Bonnett.

The *Ram's* deck tilted upward, hung there for a moment. Slowly, the slug lifted behind them, followed. They slanted down into the gut.

"One degree right," said Garcia. "Steady as she goes."

"Steady as she goes," sang Bonnett.

"Here's where we thank our lucky stars that the slug will track us in sections of hull length," said Ramsey. "If we scrape the side wall—"

"Two degrees left," said Garcia.

"Two degrees left," acknowledged Bonnett.

Sparrow glanced at Ramsey. "You were saying?"

"I was just making talk."

"Let's save the talk for rest

camp," said Sparrow. He turned back to the board in front of Bonnett. "We will take fatigue shots in three hours and at four-hour intervals until we've cleared the Arctic Circle. Let me know immediately if any of you show a Larson-reaction from them."

Bonnett said, "They tell me those shots lop the sleepless hours off your life expectancy. Wonder if there's anything in that?"

"I once heard the moon was made of green cheese," said Garcia.

"Shall we pay attention to business, gentlemen?" asked Sparrow.

Ramsey smiled. He could sense the increased vital drive in the crew like a strong outpouring of elation. He rubbed at the sore spot on his jaw where Bonnett had hit him, thought, *It came at me from an unexpected angle, but Catharsis Number One has come and gone. And I'm still alive. And Sparrow's still functioning.*

The captain cleared his throat. "As soon as we've cleared the Norwegian basin we should be out of immediate danger. Their search packs should be ranging the Iceland passage now and they won't be expecting someone from behind them. Our chief worry is picket tugs, line replacements moving up: the chance passerby."

"I've decided I'm going to die of old age," said Garcia. "That's my chief worry."

"You're getting old before your time," said Bonnett.

"One degree left," said Garcia.

"One degree left," acknowledged Bonnett.

Deep in the underwater canyon, the *Ram* coursed generally westward. At the sill of the Norwegian Basin, they lost the gut as it shoaled, crept along the basin rim, course two hundred seventy-six degrees. The bottom depth moved upward. They were in two hundred fathoms when they swung south to parallel the Norwegian coastline, course two hundred and one degrees.

At eighty-one hours, fifty-eight minutes from the well—still two degrees above the Arctic Circle—Ramsey said, "Signal!" and slapped the switch which silenced their motors.

"Course, distance and direction?" asked Sparrow.

"Southeast, ranging westerly and maybe a bit south. I'm just getting them on the outer limits of the long-range system: say thirty-five miles."

"Resume speed," said Sparrow. "They have nothing that'll reach that far."

"They'll be off my board in a minute at present course," said Ramsey.

"We'll play it safe anyway," said Sparrow. "Ten minutes run due east, then resume course."

Garcia at the helm, acknowledged. The *Ram* changed course.

"Lost them," said Ramsey.

"Resume course," said Sparrow.

Again they came around to parallel the Norwegian coast. South they went, and then west-southwest to gain greater distance from the

shore stations along the southern reaches of Norway. And again bearing to the south, and again westerly to give the Faeroes a wide berth. Now they were over the deeps south of Iceland, watch and standby: Ramsey and Sparrow on the control deck.

"You certainly called the shot," said Ramsey.

"Don't brag your luck," said Sparrow. "It'll change."

"What makes mariners so superstitious?" asked Ramsey.

"Awareness of the limits of our knowledge," said Sparrow. "And experience with the reality of luck."

"It's a wonder we don't have government issue rabbits' feet."

"I'll suggest it when we—"

"Pack!" Ramsey slapped the silencer switch. "They're onto us, skipper! They were lying doggo!"

Sparrow kicked the alarm buzzer, brought the engines to life.

"They're right in our path," said Ramsey. "Range fifteen miles."

"Sure kill range," said Sparrow. He brought the subtug and tow around to the northeast, pulled the power bar to its last notch.

Bonnett and Garcia hurried into the control room.

"A pack on us," said Ramsey.

"On the controls, you two," said Sparrow.

Bonnett and Garcia moved into their battle stations, Bonnett at the helm, Garcia on the torpedo board. Sparrow stepped to Ramsey's side.

"There's bottom at eighty-eight hundred feet," said Ramsey.

"We'll have to chance it," said Sparrow. "Les, take us down. Johnny, monitor the atmosphere."

Ramsey opened the control valve on the anhydrase generator one notch.

The subtug's deck slanted downward.

"Joe, call the depths," said Sparrow.

"Sixty-eight hundred feet and 2,880 pounds . . . 7,000 feet and 3,010 pounds . . . 7,500 and 3,235 . . . 8,000 and 3,440 . . . 8,500 and 3,655—"

"Coast in," said Sparrow.

Bonnett silenced the drive.

Garcia's voice continued: ". . . 8,600 and 3,700 . . . variation, skipper—"

"Noted."

". . . 8,700 and 3,750 . . . that's nine pounds over normal, skipper—"

"Noted."

". . . 8,750 and 3,780 . . . that's eighteen pounds over—"

"Noted. Les, flatten the glide angle and give us the bow eye on the main screen."

"Bottom in forty feet," said Ramsey. "The pack is closing fast. Range about eleven miles."

The big screen above their heads showed its pie slice of light and, abruptly, bottom mud.

"Drop the slug in first," said Sparrow.

Bonnett brought up the bow planes until they felt the drag of the slug behind them. The *Ram* settled onto bottom mud in 8,790 feet. The big static pressure gauge



read 3,800 pounds even: twenty pounds above normal for the depth.

"Pack range nine miles and fanning out," said Ramsey. "I count sixteen of them."

"Fanning out," said Sparrow. "That means they're confused by our—"

"Two breaking away toward the surface," said Ramsey. "They think we've floated up."

"Over normal pressure," said Sparrow. "There's a cold density layer above us confusing our sound pattern. Unless they detect metal, we're safe."

"Unless we implode," said Bonnett.

"If we had some ham, we could have some ham and eggs if we had some eggs," said Ramsey.

Garcia chuckled.

"The important thing is for us all to relax," said Sparrow. "We don't want the same complications we had last—"

"Complishmashuns," said Garcia. "Alla time talk-talk-talk-talk-talk. Head-thumper Ramsey wants us to talk-talk-talk-talk-talk. So he can psycho . . . psy— So he can find out what makes us go tick-tick-tick-tick-tick-tick. Don't y' Johnny-boy?"

Ramsey raised his eyebrows, looked at Sparrow. Sparrow shrugged, said, "Come along, Joe. You need a shot."

"Need a whole bottle," said Garcia. "Need a shycoan'lyst like Johnny-boy here. Don' I Johnny-boy?"

"I'm ordering you to come with me, Joe," said Sparrow.

Tears welled up in Garcia's eyes. "I need a conscience," he sobbed.

"Come along!" Sparrow grabbed Garcia's arm, jerked him toward the aft door.

"Easy, skipper," said Ramsey.

Sparrow took a deep breath. "Right."

"I'll come quietly," said Garcia. "No need get excited. I don' wanna be any trouble. I been enough trouble. I been terrible trouble. Never forgive me. Never."

He allowed himself to be led out the door, still mumbling "Never . . . never . . . never . . . never—"

"Quoth the raven," said Ramsey. He rubbed absently at the still-sensitive bruise on his jaw where Bonnett had hit him.

"That figures," said Bonnett.

"Huh?"

"Head thumper. Bu-Psych rang you in on us."

"Not you, too, Brutus," said Ramsey.

"Sure it figures," said Bonnett. "Hepp went loco, so they rang you in on us to find out why."

"What?"

"Sure. You want to see which of us is next."

"Me, if I hear any more of this nutty talk. I've—"

"Otherwise you're a spy," said Bonnett. "I guess you're not that."

"Of all the—"

"I'm trying to apologize," said Bonnett. "It isn't easy. Basically, I



don't like head thumpers. You screw doctors are all alike. Superior—know-it-all. Explanations for everything: Religion is a manifestation of deep-seated anxieties which—"

"Oh, knock it off," said Ramsey.

"What I'm trying to say is that I've felt better ever since I pounded on you. Call it a catharsis. For a minute I had the enemy in my own hands. He was an insect I could crush."

"So?"

"So I've never had the enemy in my hands before." He held up his hands and looked at them. "Right there. I learned something."

"What?"

"This may sound asinine."

"Say it anyway."

"Maybe I'd better not."

"Nothing was ever more important than for you to focalize that

thought," said Ramsey. And he thought, *No matter what I do, I'm cast in the role of analyst!*

Bonnett rubbed his hands against his shirt, looked at the control board. "When you meet your enemy and recognize him and touch him, you find out that he's like yourself. That maybe he's part of you." He shook his head. "I'm not saying this right."

"Try."

"I can't do it." Bonnett lowered his head, stared at the deck.

"What's it like? Try a comparison."

In a low, almost inaudible voice, Bonnett said, "It's like when you're the youngest and weakest kid on the playground. And when the biggest kid smacks you, that's all right because he noticed you. That means you're alive. It's better than when

they ignore you." He looked up at Ramsey. "Or it's like when you're with a woman and she looks at you and her eyes say you're a man. Yeah, that's it. When you're really alive, other people know it."

"What's that have to do with having the enemy in your hands?"

"He's alive," said Bonnett. "Dammit all, man, he's alive and he's got the same kind of aliveness that you have. Each of us is the enemy"—Bonnett's voice grew firmer—"to the other and to himself. That's what I mean: I'm the enemy within myself. Unless I master that enemy, I always lose."

Ramsey stared at Bonnett in amazement.

"Not the kind of thinking you'd expect from me," said Bonnett.

Ramsey shook his head.

"Why not? I feel things just like anybody else. So I hide it most of the time. Who am I hiding it from?" He sneered. "Me. That's who."

"What set you off?"

"I found someone I could talk to, someone who had to keep his professional mouth shut because—"

"Just a minute." Ramsey's gaze, never off the searchboard instruments for more than a few seconds, had caught a sharp-needle deflection. "Sonic search blast. There's another. If they're spaced on us, our hull will stick up like a sore thumb: a fat metal finger."

"They won't look for us down here."

"Don't count on it. There's another—"

"What's going on?" Sparrow ducked through the door into the control room.

"Sonic search bombs," said Ramsey. "The EPs are looking for a metallic bounce labeled *Fenian Ram*."

Sparrow moved closer to stand at Ramsey's shoulder. "And here comes one ranging over us."

"Fast," said Ramsey. He put his hand on the anti-torp volley switch.

"Leave that alone," said Sparrow. "They won't use a fish on an unidentified bump."

"He's inside of a mile," said Ramsey. "In the six-thousand-foot level. There goes another search bomb."

They felt the dull bump of it through the hull.

Bonnett said, "If one of our external fittings implodes, the shock wave'll crack us like—"

"We've all read the manual, Les," said Sparrow. He turned away from the board, bent his head. "Lord, we who have no right to ask it, do plead for Your mercy. Thy will be done—whatever."

"He's turning away," whispered Ramsey.

"Lord, turn not away from Thy—"

"That EP sub," said Ramsey. "He's turning away."

Sparrow lifted his head. "Thank you, Lord." He looked at Bonnett. "Joe's under sedation. Go back and stay with him."

Bonnett went out the aft door.

Sparrow again moved to stand beside Ramsey. "That was a good thing you did for Les."

Ramsey stiffened.

"I stood outside the door until he'd shed the load on his chest," said Sparrow. "You're a much deeper man than I'd suspected, Johnny."

"Oh, for heaven's sake!"

"Yes, for heaven's sake," said Sparrow. "You're a devious one."

Ramsey closed his eyes in exasperation, opened them. *I'm the father confessor whether I like it or not*, he thought. "Garcia is off his rocker," he said.

"I've shipped with Joe for quite a number of years," said Sparrow. "I've seen him drunk before. Pressure-drunkenness is no different. He's not the kind to make false accusations. That would be bearing false witness against—"

"He's just talking to—"

"He's troubled in the spirit," said Sparrow. "He needs someone like you—a confessor. Did you ever stop to think that you boys are like priests in the way—"

"I've heard it mentioned," said Ramsey, and realized he had made a confession of identity.

Sparrow smiled. "Always have a way out the other side, Johnny. Have your safe line of retreat prepared. Joe hates you right now because he doesn't want to admit he needs you."

Ramsey thought, *Who's the doctor and who's the patient here?* He said, "Are you suggesting I copper my bets in the religious gamble?"

"No bet-coppering there," said Sparrow.

"Yeah, I guess you're right," agreed Ramsey. His mouth twisted into a wry smile. "That's like telling your psychoanalyst, 'I'm going to get married as soon as my analysis is finished.' You'll never finish." And he thought, *Well, the mask is off. Why do I feel relieved? That's suspicious. I shouldn't feel relieved.*

Sparrow studied the search board. "They're almost out of range." He began to hum, then in a low voice sang, "You'll never get to heaven on roller skates! You'll roll right past those pearly gates."

"'I ain' gonna grieve my Lord no more,'" said Ramsey.

"What?" Sparrow turned away from the board.

"That's what you were singing: 'I ain' gonna grieve my Lord no more.'"

"So I was." Sparrow cocked his head toward the search board. "They're going out of range in the northeast quadrant. Surface currents set northeast here. That mean's they've decided we floated up. Give them an hour out of range."

Ramsey checked the sonic pickup monitor on the board, said, "All accounted for in that quadrant, skipper. No stake-outs."

"Certain?"

Ramsey nodded toward the monitor tape.

"They're flustered and that means bad judgment every time," said Sparrow. "Remember that, Johnny."

Keep your calm no matter what and you'll—"

"Skipper!" It was Bonnett at the door behind them.

They whirled.

"Joe's blood pressure. It's going up, then down, wider and wider. He acts like he's in shock and—"

Sparrow turned back to the board. "They're beyond range. Slide off, Johnny. Take us to six thousand feet. Fast!" He hurried toward the door. "Les, come with me."

"What about the slug?" called Ramsey.

Sparrow stopped in mid-stride, turned back to Ramsey. "I should listen to my own advice. Les, do what you can for Joe. Johnny, free the clutch on the tow cables." Sparrow moved to the main controls. "We'll have to lift the *Ram* and leave the slug on the bottom until we reach cable limit."

"Then try to jerk it off," said Ramsey.

"If we can get it to start up, the compensator system will keep it coming," said Sparrow.

"If," said Ramsey.

"Drop two of our fish," said Sparrow.

Ramsey depressed two of the red-banded torpedo switches.

The subtug shifted, remained on the bottom.

"Two more," said Sparrow.

Again Ramsey selected two matched torpedo switches, depressed them.

The subtug's nose lifted gently, seemed to hesitate, resumed its rise.

The tail came up. Sparrow fed power into the drive, raised the bow planes.

The *Ram* slid upward. They could feel the faint rumbling of the giant cable reel in the outer hull.

At seventy-one hundred feet, Sparrow said, "Try the brake."

Ramsey put pressure on the reel hub. The *Ram* strained against the lines.

"Five hundred feet more cable," said Ramsey.

Sparrow threw full power into the drive. "Lock the reel!"

Ramsey closed the switch on the magnetic brake.

The subtug came almost to a full stop, then slowly resumed its climb. Ramsey watched the towboard. "That freed her, skipper. Now, how much mud are we going to lose out of the compensator system?" He leaned to the right to adjust the atmosphere controls. "If we lose ballast, it'll be—"

"Skipper." It was Bonnett at the aft door.

Sparrow spoke without turning away from the controls. "How is he?"

"Resting easier." Bonnett looked at the big static pressure gauge. "It's only 2,790 pounds now. We got off O.K."

"Not O.K. yet," said Sparrow. "Take over the helm." He turned the wheel over to Bonnett, moved across to Ramsey's station.

"What course?" asked Bonnett.

"Steady on 197 degrees."

"Steady on 197 degrees," acknowledged Bonnett.

"We need some more luck," said Ramsey.

"St. Christopher is already getting overtime on this trip," said Bonnett.

"She seems to be maintaining hydrostatic balance," said Ramsey.

"Stay with that board," said Sparrow. "It's too soon to tell."

"Compartment Twenty-seven is fluctuating a little," said Ramsey.

"How much?"

"Maybe five per cent."

"Keep an eye on it." Sparrow went back to Bonnett's station. He stared up at the sonoran chart. "That pack left us in the corner of the northeast quadrant."

"They made a bad guess," said Bonnett.

Sparrow said, "Are you sure Joe is all right?"

"Everything was back to normal when I left him."

"Mm-m-m, hm-m-m." Sparrow nodded. "Don't sell that enemy commander short. He had inadequate information. The surface currents set in the direction he went." Sparrow pointed to the lower portion of the chart. "That's radioactive water to the south—contaminated by the British Isles. He knows we wouldn't turn east into the range of their shore stations. Ergo: we went with the current."

Bonnett pointed to the red-outlined radioactive area west of the British Isles. "There are deep cold currents setting south into that area, skipper."

"You're reading my mind," said Sparrow.

"They wouldn't be as hot as the surface layers," said Bonnett.

"It depends on how well we'd be able to follow the thermal layer," said Sparrow.

"It'd be like nosing into a one-way pipe," said Ramsey. "We'd have to follow that thermal of uncontaminated water. And what would happen if we had to come up through all that hot water? Uh, uh."

Sparrow said, "Let me figure this." He took a sheet of paper from his pocket, scribbled on it, stared at it, scribbled some more, again examined his work. "Steady as she goes on 197 degrees," he said. "It's our best chance."

Bonnett said, "What about Joe?"

"I'll go back and check him now. Stay here with Johnny. Let me know if outside water goes above 1,000 Milli-R."

"Aye."

The *Ram* coursed southward, moving closer and closer to the blighted Scottish coast, rising to shallower and shallower waters. The relatively radiation-free thermal current thinned until it was not quite twice the *Ram*'s hull diameter from top to bottom: about one hundred and twenty feet.

Sparrow returned from the rec room. "He's O.K. now. No residual effects." He stepped across to the towboard. "Any more fluctuation in Compartment Twenty-seven?"

"Negative. We haven't been in

one depth long enough for me to get a check on the pressure constant." He looked at the searchboard, watched the green face of the ranging scope. "Not a pip out of those EP packs." He turned to Sparrow. "Could we risk a slave pulse inside the slug? I'd like to get something positive on the relative densities."

Sparrow pulled at his lower lip, looked at the ranging scope. "O.K. Just one."

Ramsey set up the recording dials on the towboard, pushed the sonar pulse button. Dial needles surged; the time-over-density counter buzzed.

Sparrow said, "Ballast compartment's slow forward."

Ramsey compared the outer and inner time recordings. "Oil in the ballast," he said. "There's a pressure break on the inside."

"And we're painting an oily path on the surface," barked Sparrow. "If the EPs have an air patrol over this area, they'll spot the slick. They might just as well have an engraved chart of our course."

Ramsey turned to the autolog. "Four hours to daylight topside. What's the security word on EP air patrols over these hot waters?"

"Dunno. I wish they'd—"

"Wha's wrong?" Garcia stood in the aft door.

Sparrow said, "You're not supposed to be up. Get back to sick-bay."

"I'm O.K." He stepped onto the control deck. "What's going on?"

"We're leaking oil," said Bonnett.

Garcia's gaze darted to the so-

noran chart. "Holy Mother! What're we doing down here?"

Sparrow said, "Les, take us up. Johnny, monitor the outside radiation. Mark each 1,000 Milli-R increase. Let me know immediately if that ruptured oil compartment starts to blow." He turned toward Garcia, studied him for a moment. "Joe, do you feel up to rigging for slug repair?"

Garcia shrugged. "Why not? I've just had a good rest. What'd I do this time?"

"A cheap drunk," said Bonnett. "Where'd you hide the bottle?" He bent to turn the wheel on the bow planes.

"Two degrees! No more," barked Sparrow.

"Two degrees," acknowledged Bonnett.

Garcia moved forward, went through the door onto the engine-room catwalk.

"Reading 2,200 Milli-R," said Ramsey. "Pressure 690 pounds to the square inch."

Sparrow said, "Oil loss?"

"Fifty-five gallons a minute. Constant."

Sparrow said, "I'll take over here, Johnny. Go forward and help Joe."

"Aye."

Ramsey surrendered his position, went to the forward door, stepped through onto the catwalk. The electric engines were four droning hives around him, the gray metal of their casings gleaming dully in the standby lights. Through the webwork of gird-

ers, catwalks and ladders, Ramsey could see Garcia high above him near the escape hatch unreeling a safety line, readying it for the outside spools.

Ramsey mounted the ladders, came up behind Garcia. "Looks like we're going swimming again, Joe."

Garcia glanced back, returned his attention to his work. "This one's on me."

Ramsey bent over, steadied the spool. "Why?"

"I'm the best swimmer aboard. It stands to—"

"Somehow I got the idea you might be afraid of the water."

Garcia grinned, then frowned. "I was responsible for a man dying in a water-polo game. Broke his neck. That was supposed to be a game. This is business."

"But you just got up from pressure sickness."

"I've had a good rest." He straightened. "Hand me down that patching kit from the bulkhead rack. That's a good fellow."

Ramsey turned to the bulkhead, found the underwater patch kit, removed it. Behind him, he heard Garcia on the intercom.

"Is it Compartment Twenty-seven?"

"Yes. Why?" Sparrow's voice impersonalized by the speaker system.

"How'm I going to fix—"

"I'm doing this one, Joe. That's—"

"I'm rested, skipper, and I feel fine. Remember me? Swimming champ?"

Silence. Then, "Are you sure you feel O.K.?"

"Tiptop, skipper. Never better."

"Ramsey."

Ramsey turned, then grinned at the reaction, pushed the button on his chest mike. "Here, skipper."

"How's Joe look?"

Ramsey looked at Garcia. "Same as ever."

"O.K., Joe. But if you start feeling funny, come back in immediately. That's an order."

"Righto, skipper. How much oil we losing?"

"It's been going down as we climbed. Now it's about thirty gallons a minute. Have Ramsey rig you in a detergent suit. That oil is mucky stuff to work in."

Garcia said, "Remember in refresher school when your suit system failed? You looked like a—"

"All right, Joe. Some other time."

"How hot is it out there, skipper?"

"You can take it for about one hour, Joe. That means you should be starting back within forty minutes."

"That's cutting it close, skipper. Is there a margin?"

"I don't think so. Watch your suit counter. We're stabilized now at one hundred and fifty feet. We'll shut down and balance with the pumps. Outside pressure is sixty-six pounds to the square inch. Milli-R . . . nine thousand and fifty. You're on, Joe. Be careful."

Ramsey said, "Shouldn't I go out with him, skipper?"



"I don't want two of us on the radiation-limit list if I can help it," said Sparrow. "Get yourself rigged and stand by for an emergency call."

"Aye." Ramsey pulled a detergent suit from its locker, helped Garcia into it, tested the seals.

Garcia spoke over his suit system. "Make sure I'm tight. The suit will give me a little margin."

Again Ramsey went over the seals. "You're tight."

"Control deck, do you read me?"

"Loud and clear, Joe."

"I'm going into the hatch now."

"We'll follow you on the eyes. Be careful."

"Righto." Garcia swung open the escape hatch, clambered through, closed the hatch behind him.

Ramsey heard the water pouring into the lock chamber. He turned, pulled out another detergent suit, donned it. His own suit seals came in for a double check. He could hear Bonnett's voice over the intercom: "Lock pressure equalized. Outer door open—closed."

Sparrow's voice: "Johnny?"

"Aye."

"Into the lock as soon as the water's out of it. Seal the hatch and stand by to flood it."

High-pressure air roared and the green light beside the hatch flashed clear. "In I go," said Ramsey. He worked the outside dog controls, breached the hatch, climbed inside the escape chamber, sealed the hatch behind him. The flood-valve release light blinked on. He leaned against

the ring rail within reach of the valve, settled down to wait.

"Keep an open talk switch," said Sparrow.

"You mean me?" asked Ramsey.

"Yes. Joe's out of range of the stern eyes now."

Ramsey watched the water dripping from the damp flood-valve control, glanced at his suit snooper. Some residual radiation: about twenty-three-hour dosage. He looked around the oval compartment, up to the egg dome of the outside hatch. Garcia was out there, probably through the stricture valve by now and into the viscous crude of Compartment Twenty-seven. Ramsey could imagine the patient search by feel in the black muck of oil. His eyes began to get heavy and he opened the oxy regulator on his lung suit a crack.

The hands of the autolog swept around: fifty-five minutes.

"Ramsey!"

He snapped up, realized he had been dozing. "Aye, skipper."

"We've given Joe all the time we're able. Really too much. Go see what's wrong—and be careful."

"Right."

Ramsey spun the big wheel of the flood valve, felt the gush of water around his ankles. It surged up about him, tugging at his suit. The warning light and buzzer of his snooper came on simultaneously. The red needle swung into the seventy-minute zone.

Compartment pressure equalized.

Ramsey undogged the outside hatch, swung it clear and locked it in open position. They could free the magna-lock inside if they had to and this would save time. He pulled a handlight from its wall rack, kicked his fin flippers and drifted out the hatch opening. Immediately, he felt a wave of aloneness. No intercom out here where signals could be heard by the enemy.

The handlight picked out Garcia's safety line snaking away in the darkness. Ramsey hooked his suit ring to it, struck out along the line. The water had an inky quality that swallowed the glow of his light. He sensed the bulk of the slug ahead and above him before he could actually see it and was struck by the

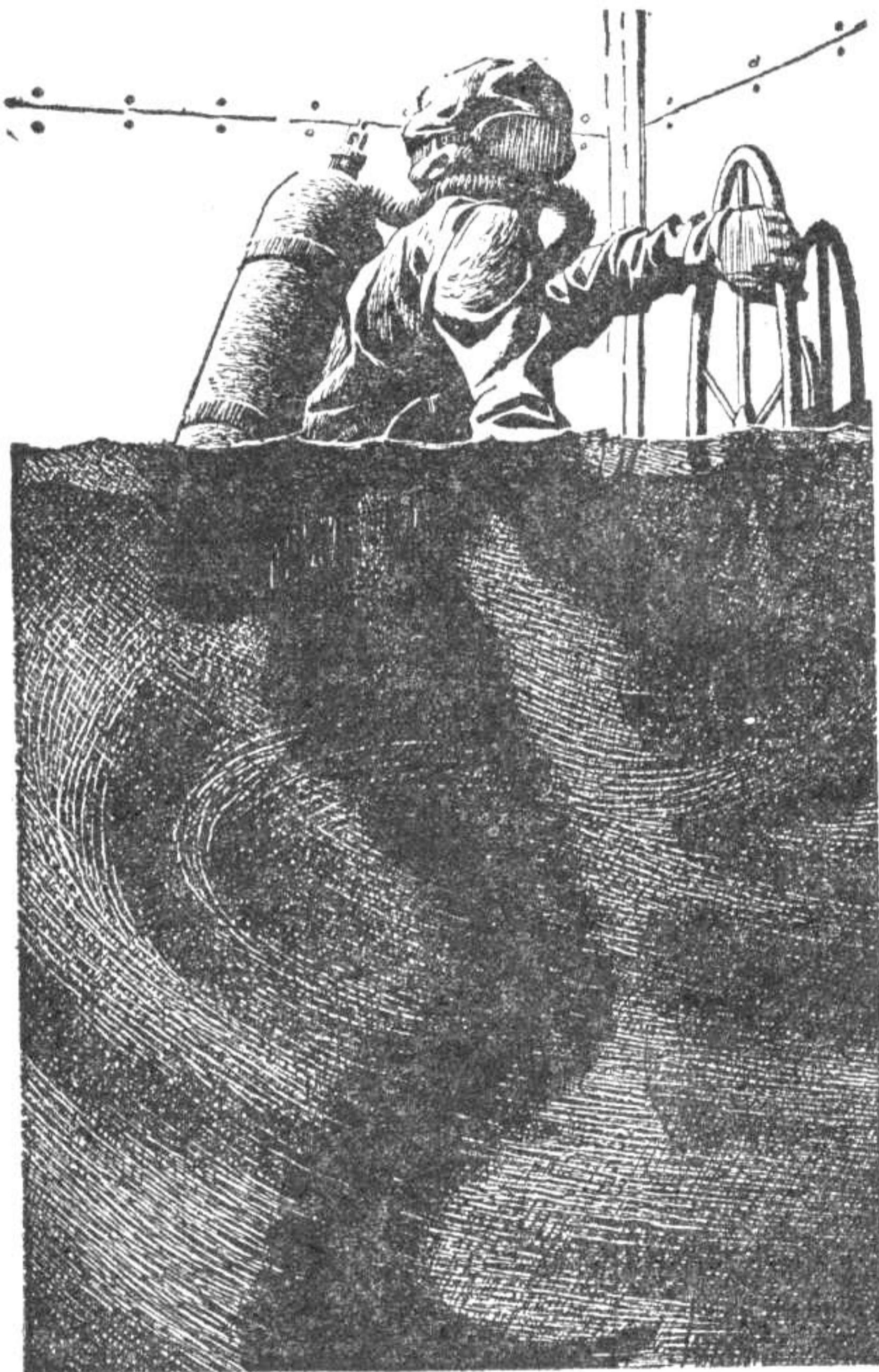

oddity of the feeling. The line ran aft along the plastic wall, looped upward onto an external knob.

Ramsey tugged at the line. No response. He swam up to the knob. A coil of the line was caught in a half hitch around the projection, the end disappearing into a tiny hole through the slug's surface.

Fouled control on the stricture valve. Ramsey freed the half hitch, again tugged on the line. He grabbed the projection, felt the valve control through it, pulled downward and turned.

A gush of oil shot out around the safety line as the hole expanded. The oil diffused upward, leaving a darker shape within its cloud. The darker shape moved toward Ramsey's light trailing an oily smudge. Ramsey closed the stricture valve, reached out and touched the moving shape. A hand gripped his shoulder through the suit: once, twice, three times.

All well.

They turned together, swam back with the safety line. The hatch light glowed out of darkness and they followed it in. Ramsey unhooked the safety line while Garcia was entering the compartment, dragged the coil in behind him. Garcia brought the hatch down, dogged it. Ramsey cracked open the high pressure air line, turned to face Garcia.

"Are you O.K. in there?" Sparrow's voice over the intercom.

Ramsey said, "Apparently, skipper."

"Joe's had a twenty-five-minute overdose," said Sparrow.

Ramsey looked at the oil-dripping shape across from him. The last water swept out of the compartment with a sucking roar. Ramsey opened the detergent nozzles, felt the hard thudding of the pressure streams. The oil swept off their suits, disappeared down the flush-out.

"O.K., Joe," he said.

Garcia remained motionless.

"Come on, Joe, let's go."

Still he remained motionless.

"Something's wrong with him, skipper."

No answer.

Ramsey motioned toward the hatch between their feet.

Garcia nodded, stepped aside. Ramsey undogged the hatch. It swung back with an assist from outside and Ramsey saw Sparrow peering up at him. Sparrow motioned toward Ramsey's throat.

Then Ramsey recognized the silence. Dead mike switch. He fumbled for it with his suited hand, caught Sparrow in mid-roar. ". . . sick bay on the double, Joe!"

"Detergent spray turned off my mike," explained Ramsey.

"You've got to watch that," said Sparrow. "Come down out of there."

Ramsey followed Garcia, helped Sparrow strip the suit from the engineering officer. The skipper helped Garcia up onto the catwalk mounting, peeled off the flipper sections. Ramsey stepped back, pulled off his headgear.

"Tired," said Garcia. "Knew

somebody'd come for me. Coulda cut my way out in 'mergency." He slid off the catwalk mounting, led the way down the stairs.

Ramsey stripped off his own suit, put both suits away, went down the stairs. Garcia and Sparrow had disappeared through the control-room door. The motors came to life as Ramsey dropped down to the central catwalk. He hurried aft and into the control room.

Bonnett stood at the helm, alone in the maze of control arms and dials. He spoke without turning. "Get on the board and help me find that thermal."

Ramsey moved to his station, checked the outside temperature reading. The radiation counter caught his eye. Needle far over in the red! "Who shut off the alarm?"

"Skipper. He had his eyes glued to it."

"Were we in that?"

"No. You had the hatch sealed before the count went up."

Ramsey shivered, stared at the dial: 42,000 Milli-R. "That's almost at a self-sustaining level. Would be if it weren't for current diffusion."

"Where's that thermal?" asked Bonnett.

Ramsey tried a short-range pulse, checked the back wave. "Try two degrees starboard . . . right."

"My, we're salty," said Bonnett.

"We're in it," said Ramsey. "Radiation dropped, too." He looked at the big pressure gauge: 262 psi.

The *Ram's* deck remained tilted downward.

"We're in it," repeated Ramsey. "Let's level out."

"Buoyancy in the tow," gritted Bonnett. He flicked the button on his chest mike: "Skipper, buoyancy in the tow."

Back came Sparrow's voice: "What's our depth?"

"We're in the thermal—about six hundred feet."

"Bring us around to westward—make it two hundred and sixty degrees even."

"What if we lose the thermal?"

"Just see that we don't."

"How's Joe?" asked Ramsey.

"Full of needle holes," said Sparrow.

Bonnett spun the helm, brought up the bow planes, dropped them, found the stabilizing point. The deck inclined forward at an uneasy three degrees.

"She wants to coon dog on us," said Ramsey.

"Why couldn't oil be a nice heavy substance like lead?" asked Bonnett. He changed the pitch on the rear planes, readjusted the bow planes, glanced at the pitlog. "The drag's cutting our speed in half."

Sparrow ducked through the door into the control room, looked to the rear plane setting, swept his glance across the control reading dials.

Ramsey abruptly realized that in the one sweeping glance Sparrow had familiarized himself with the facts of his vessel's life.

*He's part of the machine,* thought Ramsey.

"The tow's riding stern-heavy," said Bonnett. "We lost ballast from the bow. What we need is some nice non-radioactive bottom muck to replenish ballast."

Ramsey looked at the sonoran chart. The red dot on their position stood north of the Scottish skerries, course line pointing toward Newfoundland. "Seamount Olga is right in our path," he said. "Its west slope would be scoured by clean currents and—"

"It may be hotter than our damper rods," said Sparrow. "But it's a good chance. That's why we changed course."

"Outside radiation's up a few points, skipper. The thermal's thinner than our diameter here."

"Steady as she goes," said Sparrow. "The tank hull took a near limit dose back there. It'll have to go through decon anyway. Our concern now is to get that oil home."

"It's hot, too," said Bonnett.

"But usable," Ramsey reminded him.

Sparrow said, "The immediate problem is how to get that ballast off the bottom when we can't go down to it. I think we're going to have to waste another fish." He turned to Ramsey. "Johnny, do you feel hot enough on the remotes to snag our ballast hose in the fin prongs of one of our Con-5 fish?"

Ramsey remembered Teacher Reed at the torpedo base on Boco Raton.

He had patted the agate smooth skin of a thin torpedo. *"This is the Con-5. Those buttons in the nose are radar and TV eyes. Through them, you sit right in the nose of this baby while you guide her into the target."* And he had turned then to a black radio case with stub antenna protruding from it. *"Here are the controls. Let's see what you can do. This one's a dud, so you can make lots of errors."*

"Well, what do you think?" asked Sparrow.

Ramsey said, "Once that baby's out of her rack, she's charged and ready to blow. If I smack the pin into something near the hull, we've had it."

"You don't think you can handle it?"

"I didn't say that." Ramsey looked at his hands. They were steady. "I can do it if anybody can but—"

"Youth is what it takes," said Sparrow. "Les and I are growing old."

"Howdy, granddad," said Bonnett.

"I'm serious," said Sparrow. "The end of that ballast hose sticks out only about a foot. The Con-5 will have to be moving better than fifteen knots to snag the hose tightly. That means—"

"That means I'd better be right," said Ramsey.

"Right the first time," said Bonnett.

Ramsey shrugged. "Well, at Boco Raton they said I took to the Con-5 like it was—"

"Boco Raton?" asked Sparrow. "What's at Boco Raton?"

And Ramsey realized he had made another error. Boco Raton was a torpedo school—for Security specialists.

"Isn't that a Security school?" asked Bonnett.

"I missed out on my regular class because of illness," said Ramsey. "So they sent me there."

"We'll be over Olga in twenty minutes," said Bonnett.

"I'm going back for another look at Joe," said Sparrow. He turned, went out the aft door.

"Garcia's trying for homestead rights on the sick bay," said Ramsey.

"I hope he's O.K.," said Bonnett. "I don't think the skipper should've let him make that slug repair. I could've done it."

"Even I could've done it," said Ramsey. "But I guess the skipper had his reasons." He frowned. "Only I'd like to know his reason for picking me to do this snag job."

"Did you ever get into a Con-5 game?" asked Bonnett.

Ramsey suddenly grinned. "Sure. My instructor thought he was a hot-shot. So he said we'd take these two Con-5s, him controlling one, me the other. It was a touch match in the bay, first nose-hit the winner. You know, I took—"

"All right, all right," said Bonnett. "I'm just trying to make a point. I don't want a blow-by-blow. That's a young man's game, or at least a school game. We've been a

long time out of school. You haven't."

"Oh."

Bonnett chuckled. "I used to be pretty good at it, too. Tell you what: when we get back, let's hunt up a fish school and I'll challenge you to a snag match. There's the fun."

Ramsey sobered. "The skipper doesn't make mistakes, does he?"

"Not about people," said Bonnett. "Or about machines, either." He stooped to correct the setting on the bow planes. "And when we get back home they'll have him on the carpet for wasting too many fish. And what about all those spare parts?"

Ramsey thought, *A first-year psych man knows the leader of a group is the integrative force—the logos. Of course this crew has the top rating. Sparrow is—*

"It makes my blood boil when I think about it," said Bonnett.

Sparrow came through the doorway onto the control deck. "What makes your blood boil?"

"All the stupid red tape back at base."

"It's supposed to make your blood boil. That's why it exists. How far to that seamount?"

"Five minutes."

"O.K., Johnny. Let's see how good you are at Con-tag." Sparrow gestured toward the torpedo board at Bonnett's left.

"How's Joe?" asked Bonnett.

"I just shot him full of de-carb. If that hot stuff settles in his bones, he's a cooked engineer."

Ramsey approached the torpedo board slowly.

Bonnett said, "We caught him in time. He'll be as good as new in a couple of days. No calcium, no carbonate, no—"

"Just call him rubber bones," said Ramsey. "Now how about a little quiet?"

"The maestro is about to perform," said Bonnett.

Ramsey stared up at the banks of red-banded switches, the guide screens, arming triggers. And there in front of him was the little blue stick that made a Con-5 perform. He chose one off the top of the rack, keyed it to the controls, said, "Standing by. How far is down?"

"Twenty-two hundred feet," said Bonnett. "You can go any time now. It's directly under us." He slowed the engines until they were barely moving.

"We'll have hose to spare," said Sparrow.

"Shall I make a recon down to that bottom to see if I can get some muck for our hull snooper?" asked Ramsey.

"No. We have to make this one fast. An EP may pick up our control pulse. If the bottom's hot, then we'll have hot oil and they can use it to lube atomic engines."

"Now?" asked Ramsey.

"Take her away," said Sparrow. "Les, put the side lights on that hose reel."

"They're already on," said Bonnett.

Ramsey tuned the guide screen to the nose eye in his Con-5, activated the multi-wave projector beside the nose eye. The screen showed a pattern outline for the hull of the *Ram*, picked up in waves beyond the normally visible spectrum. Superimposed was the faint glow of the sidelight illuminating the hose reel. A second superimposition showed the relative positions of the *Ram* and the tiny Con-5.

"A little more ship speed, please," said Ramsey. "It'll steady us."

Bonnett moved the throttle bar forward a fractional notch and the *Ram* picked up speed.

Ramsey brought the deadly torpedo in closer. He could not see the fin prongs on his torpedo, but he knew where they were—forward projecting edges of the stabilizing fins, designed for hydrostatic balance and set just back of the needle curve of the torpedo's nose.

"Blink the sidelight," said Ramsey.

Bonnett winked the light switch off, on, off, on.

The glow on Ramsey's guide screen went on and off to the movement of the switch.

"Wanted to make sure that was the correct light," said Ramsey. He flashed the Con-5 in close and hovered it over the light. The hose projection was visible ahead, jutting at a forty-five-degree angle from the reel base.

"O.K.," he said. "Here goes." He dropped the Con-5 back ten feet,

threw full power into the torpedo's drive. It surged ahead, swooped down onto the hose, seemed to hesitate, then ranged away from the *Ram*.

"You got it," said Bonnett.

"What else?" asked Ramsey. He slacked off the speed of his torpedo, looked at the counter dial which showed how fast the hose was unreeling. Abruptly, the dial showed a slowing down, slacked off to zero.

"Lost it," said Sparrow.

Ramsey brought the Con-5 around in a sweeping curve. The snaky line of the hose was the superimposed outline now. He brought the little torpedo in fast, tipped it at the last minute like a hungry shark and again had the hose in tow. "Got a better hold on it that time."

"I'm bringing us around on that seamount," said Bonnett. "I have you on the searchboard. I'll warn you one hundred feet from bottom. You can take it in visually from there."

"I picked up the hose about ten feet from the end that last time," said Ramsey. "Get the pump going the minute I touch the nozzle into the muck; that'll hold her there. I don't want to hold that firing pin any closer to a target any longer than I have to."

"Pump ready," said Sparrow.

Ramsey glanced sideways, saw Sparrow at the towboard. Sparrow's hands moved over the controls. "Line checks clear to the ballast compartment," he said.

Ramsey visualized the ballast con-

nections running aft, through the tow controls and into the web-mesh which linked *Ram* and slug. If that linkage remained sound . . . if he could plug that hose end into ballast muck . . . if—

"One hundred feet," said Bonnett. "You're bearing along the east face of the seamount."

"I have its outline," said Ramsey, eyes on screen.

He maneuvered the torpedo closer to the bottom.

"Ledge," he said. "That'll have muck."

"Pray it's cool," said Sparrow.

"Pray it's ballast," said Ramsey.

He edged the torpedo and its hose end closer to the bottom, closer, closer—

"She's in!"

"Pump on and—holding," said Sparrow.

Ramsey tipped the Con-5, freed it from the hose, brought it up away from the bottom.

"Standby with that thing," said Sparrow. "We may have to move the hose."

They waited.

"The slug's bow is coming down," said Sparrow. He hit the switch of a ballast snooper. "It's cool."

Slowly, as the *Ram* circled over the seamount, the slug came to hydrostatic balance. Presently, Sparrow said, "O.K., Johnny, find some deep bottom for that Con-5, set it down, disengage and leave it. Don't let it blow."

"Aye." Ramsey took the little torpedo down along the flank of the

seamount, found a deep ledge and set the deadly metal fish down. He shut down the remote-control system, stepped back.

"Hose coming in," said Sparrow. "Take us down into that thermal, Les. Course 260. Johnny, how about looking in on Joe?"

"Aye, skipper." He felt suddenly exhausted, but buoyed by an inner nervous exhilaration.

"Then get some rest," said Sparrow.

Ramsey turned aft, went to the door, stooped through and went to the rec room sick-bay.

Garcia lay on the sunlamp cot clad only in a pair of shorts. He was on his back, one brown arm thrown across his eyes. Dots of perspiration glistened on his dark skin. As Ramsey entered the room, Garcia lifted the arm from his eyes, peered from under it.

"Oh, it's you."

"Who'd you expect? The surgeon general?"

"Aren't we funny!"

Ramsey put the back of his hand against Garcia's forehead. "Fever?"

Garcia cleared his throat. "Some. Those damned decalcification shots."

Ramsey glanced at the chart Sparrow had taped to the bulkhead above the cot. "You're due for another shot right now. De-carb and de-phos. Another de-sulf in an hour." He turned away, went to the pharmacy locker across the room, saw that Sparrow had set out the hypodermics in sterile seals, labeled them.



"What have we been doing?" asked Garcia.

Ramsey turned with the hypo, said, "Getting a new cargo of ballast for the slug. Turn over."

"This one in the left arm," said Garcia. He held out the arm, watched while Ramsey swabbed the area, administered the injection, returned the hypo to the pharmacy rack.

Garcia spoke behind him. "Have you and your little black box finally got the skipper figured out?"

Ramsey's muscles locked. He took a deep breath to quiet his nerves, turned. "What do you mean?"

Garcia's face bore a twisted smile. "Don't play it innocent, Johnny. Remember me? I'm the guy who's capable of taking over the electronics shack if you crock out."

"But—"

"My hobby is breaking and entering," said Garcia. He put his hands under his head, winced as he moved his left arm. "You've heard about Pandora's box?" He managed a shrug by lifting his eyebrows and making the slightest movement of shoulders. "You shouldn't put temptation like that in front of a guy like me."

Ramsey wet his lips with his tongue. "You mean the test equipment for the long-range—"

"Really, old boy, don't you know when the jig's up?" He stared at Ramsey, a calculating look. "The gear in that box is tied to the skipper some way. I don't know how, but—"

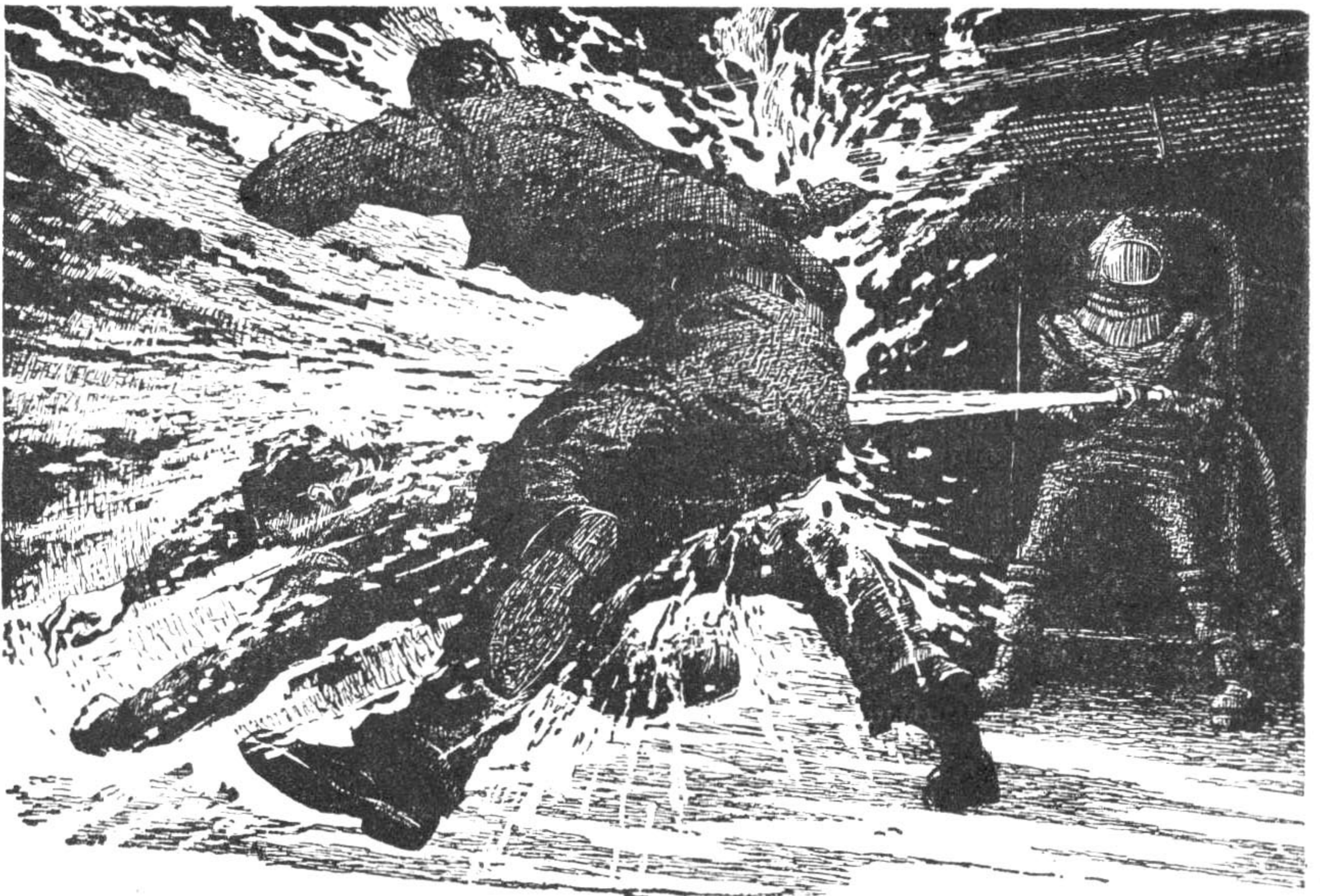

"Oh, come off of that," said Ramsey. "You—"

"I put it to the acid test," said Garcia.

"Acid test?"

"You're a deuced reluctant type, Johnny. If I didn't—"

"Start at the beginning," said Ramsey tiredly. "I want to know what you think."

"Fair enough," said Garcia. He wriggled into a more comfortable position on the cot.

Ramsey brought up a stool, sat down.

"In the first place," said Garcia, "you didn't offer to introduce me to the intricacies of your little black box. That was a mistake. Any normal E-man would've been all eager to share his gadget with another man aboard who could talk shop." The smile tugged at the corners of Garcia's mouth. "You, by the way, don't talk shop."

"So?"

"So there's nobody else aboard who talks your particular brand of shop."

"Is that when you figured me for a spy?"

Garcia shook his head. "I've never figured you for a spy." He frowned. "Sorry about that. Maybe I could've saved you a bad time with Les. I've been certain all along that you were not a spy."

"How could you be?"

"Too inept." Garcia hesitated. "And besides, my wife is a cousin of commander of the *Dolphin*. He

was very impressed by a fellow named Long John Ramsey from Bu-Psych who pulled them out of a nasty spot when their oxy system went sour. He says this man Ramsey improvised a special vampire gauge and pulled some stunts with anhydrase that weren't in the books. Seemed to think this Ramsey saved their lives."

"So you figured me for this same Ramsey."

"He was *extremely* impressed by this Long John Ramsey except for one thing: he said the redhead got on your nerves with his know-it-all attitude!"

"The world's full of redheads—"

"Uh, uh!" Garcia shook his head. "You're Bu-Psych. Two things on this floating sewer pipe interest you more than anything else: the skipper and that black box in your room. So I opened the box."

Ramsey forced himself to remain impassive. "And?"

An enigmatic grin captured Garcia's features. "There's a separate set of recording instruments in it keyed to the autolog. I copied four of your tapes, checked back on what we'd been doing."

"What'd that prove?"

"Whenever the skipper's asleep, your graphs flatten. Every time."

Ramsey shrugged, remained silent.

"But I needed the clincher," said Garcia. "Twice when the skipper hurt himself—a barked shin and one electric shock—I logged the exact time. The squiggles on a couple

of your tapes go wild at exactly those moments."

Ramsey recalled the tape gyrations, his own cautious questioning to find the reasons. "Clever."

"Thank you, old chap. I thought so myself."

"What's all this prove?"

Garcia raised his eyebrows. "It proves you're making some kind of record of the skipper's internal chemistry. Only one type of fellow is that interested in why people tick."

"Yes?"

"He's vulgarly referred to as a head-thumper."

In spite of himself, Ramsey grinned. *So I'm all washed up*, he thought. *So I'm in good company.*

"I don't believe I'm going to give you away yet," said Garcia. "This show hasn't played itself out. I must remember to thank Bu-Psych, too: for one of the most entertaining cruises I've ever had."

"I suppose you want into the act," said Ramsey.

"Good heavens, no! I already have my part to play. Just one thing, old fellow. Don't sell our Captain Savvy Sparrow short."

"Oh?"

"He's the director of this show. Whether you know it or not, he controls the script."

Ramsey fought down the vague tuggings of disquiet. "Is that why you're not giving me away?"

"You obviously mean well," said Garcia. His voice went lower, more harsh. "Now, give me my other shot and get the hell out of here! Your

air of superiority is beginning to wear on me."

Ramsey felt the hot blood suffusing his features. He took two quick breaths, surged to his feet.

Garcia deliberately turned over, spoke with his mouth muffled slightly by the pillow. "Left buttock this time, old thing. Try not to work your temper out on me while you're about it."

Ramsey went to the pharmacy locker, returned with the hypo, administered the shot, replaced the hypo in its rack.

"That was very gentle," said Garcia. "Good control."

Ramsey walked across the room, stood over the cot. "What air of superiority?" he demanded.

Garcia rolled onto his back, grimaced, said, "I don't mind your dislike of me or Les, but by heaven, you owe your life to—"

"That's enough!" barked Ramsey. "You talk about superior! Every one of you has been so superior it—"

"Oh, I say!" Garcia stared up at him. "We all have our soft spots. Evidently the junior ensign—"

"You've had your inning," gritted Ramsey.

"So I have." Garcia nodded. "Maybe you've just wanted to be one of the gang. In spite of—" He fell silent.

"In spite of what?"

"Your other job."

"Maybe because of it," said Ramsey.

Garcia digested this. "I never

thought of that. But it makes sense. You psych boys must be pretty lonely. All your friends—outside the profession, that is—always on guard lest you pounce.”

Ramsey shoved his hands into his hip pockets. “Where’d you get this low opinion of psych?”

“Watching you operate, doctor.”

Ramsey sniffed. “You’ve never seen me operate.” He kicked the stool closer to Garcia’s cot, sat down. “You’re going to talk shop.”

Garcia raised on one elbow. “Now see here, old thing, I really—”

“Your secret’s showing,” said Ramsey.

Garcia’s face went blank. “What . . . did . . . you . . . mean . . . by . . . that?”

“You act like a man under some contra-survival threat greater than the fear of death. You keep making sacrificial gestures, as though you were seeking to excuse—” Ramsey fell silent, staring at Garcia.

“Well?”

“I never brought it into concrete focus before, Joe. Did you have anything to do with the death of that Security lieutenant?”

Garcia sank back onto his pillow. “No.”

“Even indirectly?”

“I didn’t know a thing about him until we found him.”

Ramsey started to nod, then thought, *Wait a minute! That’s not a direct answer. A clever evasion phrased like an answer.* He said, “Wouldn’t an outright lie be preferable?”

Garcia stared at the ceiling, mouth held in a harsh line.

“O.K., we’ll talk about something else, Joe.”

“Why don’t you go talk by yourself?”

“You’re such pleasant company I can’t bear to leave. Tell me, Joe, outside of psych men who look through your sham wall of inadequate defenses—”

“Look, fellow!” Garcia turned his head on the pillow until he was staring directly at Ramsey. “So you came out after me when I was caught in the slug. That was your boy scout good deed for the day and I thanked you nicely when we got back, but—”

“Thanked me?”

“Oh, I forgot, you goofed with the detergent jet and had your hearing aid turned off. No matter. I was about to say that your gesture wasn’t necessary. I could’ve cut myself out of the slug if the need arose. So we’re—”

“What with?”

“Huh?”

“You stripped your pockets before getting into the lung suit. Your knife was right there on the suit ledge when I got ready to go out. What were you going to cut yourself out with—the patch scraper?”

Garcia’s dark features grew pale.

“You’re welcome,” said Ramsey.

“You’ve suddenly built your part up greater than it first appeared, Johnny. Who does your scripts?”

“It’s just that you’ve never really seen me operate,” said Ramsey.

"Now, I started to ask you a question. I'd like a straight answer and we'll call it even. O.K.?"

Garcia smiled thinly. "Righto."

"What is it about this service that really gripes a submariner?"

"Nothing gripes us," said Garcia. "We love our work. There's really nothing in this whole wide world to compare with the subtugs. It has playing grab-tail with a panther pushed completely off the jolly map. Now, you take—"

"I'm serious, Joe. I'm looking for something that's bottled up way inside you. I think I know what it is, but I want to hear it from someone else. Someone like you who knows people and submarines. I think we've been looking in the wrong direction."

"What do you want to know?"

"I'm not going to put the words in your mouth. I want to know what it is about this service that really burns you up—the thing you don't even talk about among yourselves?"

Again Garcia lifted himself on one elbow. He grimaced as he moved the arm which had received the earlier shot. "All right, Johnny boy. You deserve a straight answer for being such an observant chap—about knives and such. You saw how we shoved off?"

"Yes."

"Sneaking off. You know—just routine."

"That's Security."

"Stuff Security! Do those fatheads imagine the EPs are ignorant of the location of our bases?"

Ramsey shook his head. "Well, Security can be sure the EPs know where *our* home base is. They can be sure if they got our squirt message, that is."

"They should be sure without our message! This cops-and-robbers routine is one big ache. Air cover and sea patrol are the real reasons there aren't wolf packs waiting at the outlets of all five of our—"

"Five?"

"Five bases, Johnny. Every submariner knows about 'em. The sub skippers know; so the men know. That's survival and Security can go blow that out its bloody bum—"

"I don't get you, Joe. Sorry."

"Johnny, let's say you're the only man aboard able to operate the ship. The rest of us are all gowed up somehow or other. Say a pile flare-up. It's survival, Johnny, for you to know that the radiation medical center is at the other end of the Charleston short tunnel and that the tunnel opens into Charleston harbor just inside the mole and a hundred feet left."

"I see what you mean. So we have five bases."

"We used to have six. Then the EPs sabotaged one of our subcruisers and it blew while going down-tunnel—like we almost did. That's the Corpus Christi crater you've—"

"Wait a minute!" Ramsey shook his head. "That was an EP war rocket. It was aimed at—"

"Swamp mud! It won't wash, Johnny. That doesn't explain how the alleged war rocket pierced our

'perfect' robo-slave defenses and hit smack on that tunnel."

"What tunnel?"

"Johnny, I've been up that tunnel. So've a lot of other fellows in the subservice. Security may peddle its pap to somebody else, not to us. You can't tell me a rocket launched in Siberia can center on a hole in the ground in Texas—even by accident. That's stretching probability or accuracy." He sank back onto his pillow.

"Let's grant your argument," said Ramsey. "What's that have to do with my original question?"

"You still want to get way inside my head?"

"I'd like an answer to my original question."

Garcia stared at the ceiling.

"Right, Johnny. The answer you want goes something like this: There are men all through the services—not just the subs—who are so sick of war—year after year after year after year of war—so sick of living with fear constantly that almost anything else is preferable. Death? He's an old friend—a neighbor just beyond the bulkhead there. Lots of things become preferable. Fouling up the works, for instance, to let the other side win. Just so somebody wins and that puts a stop to the thing—the stupid, foolish, never-ending thing." His voice trailed off and he turned, stared emptily at the bulkhead behind Ramsey.

"That's insane," whispered Ramsey.

"Certainly it is," said Garcia faintly, "but you're not going to argue that war is sane. We're human beings, whatever that means. If insanity is the pattern, that's us and you'll find little that's contradictory. Just little scratches of sanity where the blood runs through a different color."

"Oh?"

"Like the skipper. You've seen him pray for the souls of the men he kills. That's a scratch of sanity. You can feel it." He turned a fierce glare on Ramsey. "Do you ever wonder what they're like—those other fellows? Perdition! They can't be so very much different from us. They have wives, kids, sweethearts, hopes, fears. I know it as certainly as I know I'm here now that there are people over there who feel the same way about this stupid war as we do." His voice rose. "Anything! Just to get this thing over with! It's like a pain that's way inside your chest and it won't stop. It goes on and on and on and—"

"Easy, Joe."

Garcia relaxed. "O.K."

"That's battle pressure," said Ramsey. "I was thinking of something else." He hesitated. "No, maybe you were talking about the same thing."

"Such as?"

"It has to do with death instincts, Joe."

"Oh, and it's too deep for the likes of me?"

"I didn't say that."

"You implied it, Johnny. Some

more of your esoteric nonsense. I've had a normal amount of psych study. I've read the old masters and the new: Freud, Jung, Adler, Freeman, Losi, Komisaya. I went looking for answers and found double talk. I can speak the jargon."

"So you know what a death instinct is."

"Sure, Johnny. The EPs and us—we're moving blindly toward our mutual destruction. Is that what you wanted me to say?"

"I guess not. I had something else in mind. Maybe I'm wrong."

"Or maybe I like to be blind, too."

"Yes. We were on another track earlier, Joe. You didn't answer. Are you ready to tell me if the EPs have ever approached you to do their dirty work?"

Garcia looked at him coldly. "I hope to see you in hell," he said, enunciating the words precisely.

Ramsey got to his feet. "You've been a big help, Joe. But you're really supposed to be resting." He pulled a light blanket from a wall hangar, threw it over Garcia, turned away and went to the door.

Garcia said, "Do you think I'm a sleeper?"

Without turning, Ramsey said, "Would a sleeper have taken an overdose of radiation to keep us hidden from the EPs?"

"Maybe," said Garcia, "if he didn't like his job and was as tired of war as I am."

*And that, thought Ramsey, is pre-*

*cisely the answer I was afraid of.* He said, "Get some rest."

"Bit players hamming up their parts," said Garcia.

Ramsey stepped out into the companionway and it was a cold gray corridor suddenly—leading nowhere in either direction. He thought, *My world's gone completely schizoid. Security! Its job is to make us even more schizoid—to break down as many lines of communication as possible.* He turned and looked back at Garcia on the cot. The engineering officer had turned on his side, facing the bulkhead. *That's why it's so important to belong to Savvy Sparrow's group. That's the scratch of sanity.*

And he remembered Heppner, the electronics officer who had gone mad. *If you can't belong and you can't leave: What then?*

The shape and substance of things began to reform in Ramsey's mind. He turned up the companionway, went to the control deck. The room seemed to greet him as he stepped through the door: warmth, flashing of red and green lights, a sibilant whispering of power, a faint smell of ozone and oil riding on the background of living stink which no filters could completely eliminate.

Sparrow stood at the helm, an almost emaciated figure with rumpled clothes hanging loosely upon him. Ramsey was suddenly startled by the realization that Sparrow had lost weight when there didn't seem

to be any place from which he could lose it.

"How's Joe?" Sparrow spoke without turning.

*Saw my reflection in the diveboard glass, thought Ramsey. Nothing escapes him.*

"He's going to be all right," said Ramsey. "His vein counter shows negative absorption. He may lose a little hair, be nauseated for a while undoubtedly."

"We ought to set him into Charleston," said Sparrow. "The vein counter doesn't tell you what's happening in the bone marrow. Not until it's too late."

"All the signs are good," said Ramsey. "Calcium leeching out and being replaced by non-hot. Sulphates negative. He's going to be O.K."

"Sure, Johnny. It's just that I've sailed with him for a long time. I'd hate to lose him."

"He knows it, skipper."

Sparrow turned, smiled, a strangely plaintive gesture. "I guess he does, at that."

And Ramsey thought. *You can't tell a man you love him—not if you're a man. That's a problem, too. We don't have the right word—the one that leaves out sex.* He said, "Where's Les?"

"Getting some rest. We hit the Arctic stream twenty minutes ago."

Ramsey moved up to the searchboard station, rested a hand on the wheel to external salvage air beside the board. His mind was full of moving thoughts. It was as though the conversation with Garcia had

tapped a well—or had dropped head pressure and allowed what was underneath to come to the surface.

"Les will take the next watch in an hour," said Sparrow. "I can handle her now. You come on in three hours. We'll need a tighter schedule without Joe."

"Aye, skipper."

He turned, went aft to his quarters and was suddenly aware of a bone weariness. It was too much trouble to get out the telemeter and inspect its tapes. Besides, he knew what it would show: the iron-hard inner control that simulated normality. Or maybe it *was* normality. He fell asleep on the bunk without undressing.

The *Ram* bore southwest toward home waters, and the autolog reeled off the days. A monotonous succession of watches amidst the cold pipes, dials, wheels, levers, blinking lights and telltale buzzers. The same faces and the same danger.

Even peril can grow boring.

A distant sound of propellers in an area where all such sounds mean *hunter*.

Wait and listen. Creep ahead a few knots. Wait and listen. Creep ahead a few knots. Wait and listen. The distant sound is gone. The *Ram* picks up speed while red-rimmed eyes watch the ranging and sonar gear.

Garcia was up and about on the fourth day, a man grown strangely morose and sullen when Ramsey was present.



Still the subtug moved steadily nearer to safety, towing the turgid slug: a prize wrested from death itself.

And a special tension—a new pressure—crept into the actions of the *Ram's* crew. It was tension that said: "We're going to make it—We're going to make it—We're going to make it—

"Aren't we?"

Ramsey, asleep in his bunk, wrestled with a silent nightmare in which Sparrow, Garcia and Bonnett suddenly turned to face him—all with the features of mad Heppner.

Slowly, the nightmare lifted and left him peaceful in the womblike stillness of the ship.

Stillness!

Ramsey sat bolt upright in his bunk, wide awake, every sense crying out against the strange new element: quiet. He reached behind him and snapped on his bunk light. It was dim—showing that they were on emergency batteries.

"Johnny!" It was Sparrow's voice over the wall speaker.

"Here, skipper."

"Get up to your shack on the double. We're having pile trouble."

"I'm on my way!"

His feet hit the deck, fumbled into shoes. He snapped off his bunk light, ran out the door, up the ladder two steps at a time, down the companionway and into his shack station, talk-switch open. "On station, skipper. Is it serious?"

Bonnett's voice came back. "Full scale flare-up."

"Where's the skipper?"

"Forward with Joe."

"Joe shouldn't be anywhere near that! He's still on the hot-list!"

"It was Joe's watch. You know how—"

"Johnny!" Sparrow's voice over the intercom.

"Here."

"Secure the shack for minimum power drain and come forward."

"Right." Ramsey found that his hands knew automatically which switches to hit. He blessed the long hours of practice with the mock-up board. This was what Reed had meant: "*There is no such thing as a minor emergency aboard a submarine.*" He made the conventional glance-around double check: standby light glowing amber, all jacks out, main switch up, relay circuit to control room plugged in and green. He thumbed his chest mike: "Les, she's all yours."

"On your way."

He ran out the door, turned right up the companionway, through the control room without glancing at Bonnett, and out onto the central catwalk. The laboring hum of one engine turning slowly on battery power to give them headway permeated the engineroom.

Garcia stood beside the tunnel hatch down forward to the left, his hands fumbling with the zipper of an ABG suit.

Ramsey's first thought was, *What's wrong with Sparrow? He can't let Joe go in there!* Then he

understood the significance of the scene.

The nozzle of a detergent hose was racked beside Garcia. Sparrow stood about twenty feet away on the lower catwalk. The space between them showed raw splashes of detergent spray. As Sparrow took a step forward, Garcia stopped working with the zipper, put a hand on the nozzle.

"Stay where you are, skipper!"

Garcia's voice was metallic; it echoed in the engineroom. Ramsey realized the man was talking into the open mike of his ABG suit.

Sparrow took another step forward. "Don't be a fool, Joe!"

Garcia lifted the hose nozzle, pointed it at Sparrow. "One step more and I'll let you have another taste of this."

Ramsey went to the left-hand ladder, dropped down to Sparrow's level. He saw that the front of Sparrow's uniform was dripping with the detergent, and winced at the thought of what that high-pressure jet spray could do to a man.

"Shall we rush him, skipper?" he asked. "I could drop down to—"

"Well, if it isn't the head-thumper," said Garcia. The zipper on his suit suddenly un-jammed and he pulled it closed, reached back and folded the hood forward over his head, sealed it. The quartz plate front gleamed at them like a malignant cyclops eye.

Sparrow glanced at Ramsey, turned back to Garcia. "We couldn't move an inch against that hose. We have to reason with him."

"Let the head-thumper reason

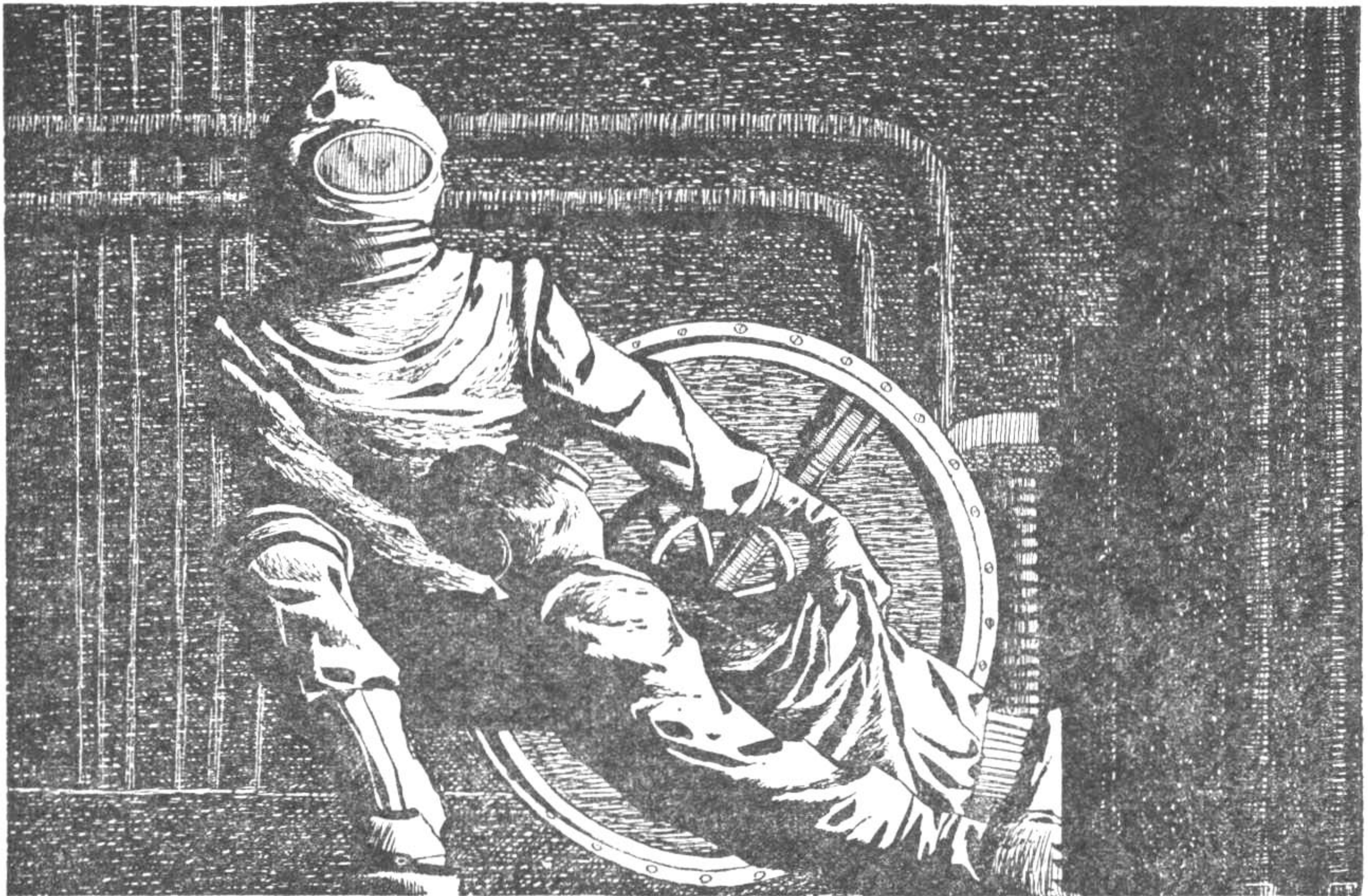

with me," said Garcia, his voice booming from the bulkhead speaker above him. "That's his department."

"He's only four days from a radiation overdose," said Ramsey.

"This is my show," said Garcia. "This is my big scene. I'm going to crawl that tunnel and there's nothing you can do to stop me. Besides, I know this end of the ship better than any of you."

Ramsey looked down at the open door to the tunnel, realized abruptly that it was the same tunnel in which they had found the dead Security officer.

Garcia half-turned toward the door.

"Joe, stop!" barked Sparrow. "That's an order!" He made a sudden dash forward, was bowled over backward by a hard stream of detergent spray.

Behind him, Ramsey caught part of the spray, slipped to his knees. By the time they had scrambled to their feet, Garcia had disappeared into the tunnel, closing the door behind him.

Sparrow said, "He took a wrecking bar in with him. He's going to jam the hatch dogs so we can't follow him."

They heard metal banging on metal.

Garcia's voice came over the bulkhead speaker. "That's right, skipper. Can't have you fellows trying to steal my scene. You have front-row seats; enjoy the show."

Sparrow slipped down to the tun-

nel door, tested the dogs. "Jammed!"

"Has he gone psychotic?" asked Ramsey.

"Of course not!" barked Sparrow. "There's a full-scale flare-up in that pile room. He's gone in to do what he can."

Ramsey looked at the snooper above the tunnel door, saw that its needle was jammed in the red. "Skipper! It's hot here!"

Sparrow slapped the snooper with one hand and the needle swung back into the seven-hour-limit zone. "Jammed when he opened the door." He turned toward the tool rack beside the door. "Joe! Do you hear me?"

"Sure, skipper. No need to shout. I'm almost at the tunnel curve."

"Joe, defiance of orders is a serious offense."

Garcia's laughter roared from the speaker. "So sue me!"

"What happened in the pile room?" asked Ramsey.

Sparrow began pulling tools from the rack. "Our repairs didn't hold. Tie bolts sheered. The whole reactor slipped to the left, blocked the remote-control bank." He glanced at his wrist watch. "The batteries will give us steerage for about another thirty minutes. When we lose steerage, the planes won't be able to hold us level and over we go. Over goes the pile. If we're lucky, it'll reach critical mass. If we're unlucky, the whole ship will be contaminated and us with it. That'll be the slow way out."

"And if Joe lives through this, you'll have his hide," said Ramsey. "Even though he's risking—"

"You blasted idiot!" shouted Sparrow. "What do you mean *if he lives*? Don't you know there's only one way to get that pile back onto its base?"

All Ramsey could think was, *I did it! I cracked through that iron control! Now his emotions can take a normal—*

"Skipper!" It was Bonnett's voice over the intercom.

Sparrow spoke into his chest mike. "Yes?"

"I'm tuned to the portside pile room eye over the tunnel plates. They're moving out toward— Good God! Joe! Get out of there! Skipper! He's in the pile room!"

"That's what I meant," murmured Sparrow.

"Now hear this!" It was Garcia's voice from the bulkhead speaker. "I can last maybe fifteen minutes. When I get the remote-control bank cleared, be ready to take over."

"Sure, Joe," whispered Sparrow. He swung open a panel on the forward bulkhead, revealing the direct controls to the left-side bank. The telltale lights glowed red when he threw on the switch.

"He's a dead man already," said Ramsey.

"Quiet!" barked Sparrow. "Tune that bulkhead screen above us to that pile room eye."

Ramsey jumped to obey. The screen came to life. It showed Garcia's figure, bulky in an ABG suit.

He was bent over, rigging jacks to force the reactor back onto its foundation. As they watched, Garcia began to turn the screws. The deadly block inched toward its proper position. They could feel Bonnett adjusting the planes to accommodate for the shifting weight.

Sparrow bent over the tools he had removed from the bulkhead rack, hefted a big Stilson wrench. "Let's try one of those dogs," he said.

"The only way he could've jammed it is from the bottom," said Ramsey. "If we force it down, break it off and—"

Sparrow fitted the wrench to the upper dog, said, "They drilled you well for your little job."

*Now, what does he mean by that?* thought Ramsey.

"Here, give me a hand," said Sparrow.

Ramsey took hold of the wrench. Together, they bore down on the handle. The dog twisted, snapped off. Ramsey took a punch and hammer from the stack of tools, knocked the fitting through the door into the tunnel.

Sparrow had the wrench fitted to the other dog.

Ramsey glanced up at the screen. The reactor was back on its foundation, and Garcia was securing it with new lag bolts.

"Let's go," said Sparrow.

They snapped off the other dog, heard a clatter of metal in the tunnel as Garcia's wrecking bar fell away.

Sparrow pried the door open, swung it wide.

The snooper's needle jammed in the red.

"Suits," said Sparrow. He motioned toward the locker.

"Skipper." It was Garcia's voice from the speaker. "Tell my wife she doesn't have to be afraid any more. She'll understand."

"Sure, Joe."

"Tell her to go some place and change her name."

"Why?"

Ramsey passed him an ABG suit, began scrambling into his own.

"Johnny'll understand."

Sparrow slipped into the suit, looked at Ramsey. "Well?"

Ramsey shook his head, unable to speak.

Sparrow spoke into his suit mike as he sealed the hood in place. "Joe, we've forced the door. I'm bringing in the detergent hose and a cool suit. Come out of there."

"I'm too hot," said Garcia. "Leave me here."

"Come out or I'll come in after you," said Sparrow.

Ramsey handed Sparrow a fresh ABG suit, glanced up at the bulkhead screen. It showed Garcia's squat figure, standing beside the tunnel plates. Above him, one of the giant remote-control manuals swung outward. At the same time, Bonnett's voice came over the intercom. "The control bank's free, skipper. I can take it from here. Get that fool out of there! He may still have a

chance!" Bonnett's voice was almost sobbing.

"I'm coming in after you," said Sparrow.

"You don't understand!" shouted Garcia. "Stay out of here, skipper!"

"I'm coming," repeated Sparrow. He freed the detergent hose from its reel clip.

Garcia's voice rose almost to a scream. "Skipper! I'm your spy! Don't be a fool!"

"You're my engineering officer," said Sparrow. He bent for the tunnel, slid into it, dragging hose and suit behind him.

Garcia's voice came to them: "You can't—" He fell silent, choked, coughed, collapsed onto the reactor room floor.

Around Ramsey in the engine-room, lights brightened, the four motors resumed their normal humming. He could feel the *Ram's* response through his feet as though it were a report from someone outside himself. He was unable to tear his gaze from the screen: The giant manual arm swung out over Garcia's prone figure, clasped him gently, lifted him into the tunnel, replaced the cover plates.

"I've got him," said Sparrow. A gush of detergent washed out the mouth of the tunnel.

Ramsey jumped to the bulkhead console, started a pump to remove the hot fluid.

"Johnny!" Sparrow's voice.

He spoke into his suit mike. "Here, skipper."

Sparrow's voice grated. "You

don't have to help in this, Johnny. Get away from the tunnel mouth if you value your virility. Joe's hot. Very hot."

"I've already got two kids," said Ramsey. "Bring him out. I'm wearing an ABG suit."

"Here he is."

Garcia's limp body was extruded from the tunnel mouth like an insect from its burrow. Ramsey eased him to the deck. Sparrow followed.

"I almost drowned him in detergent getting him into this suit. It's already too hot."

Ramsey bent over, unzipped the front of Garcia's suit. Sparrow helped him pull the limp figure from it. They hustled Garcia into the decontamination chamber. Sparrow removed his own suit, went in with Garcia. Ramsey took the suits, stuffed them into the tunnel mouth, stripped off his own, and pressed it in after the others. He closed the door, wedged it with the wrench.

The door to the decon chamber popped open. Sparrow emerged nude, dragging Garcia after him in like condition. "We'll have to replace every drop of his blood," said Sparrow. "Get in there and shed your clothes, then come up to the rec room." He stooped, lifted Garcia over his shoulder and went up the ladder to the catwalk, muscles knotting on his legs and back with the strain of the load.

Ramsey paused to speak into his chest mike. "Les, skipper is bringing Joe up. Better lend a hand." Then he ducked into the decon

chamber, slapped the medium-jet control. The harsh streams, designed for a man in a protective suit, bit into his flesh with a stinging pressure. Ramsey shucked out of his hot clothes, kicked them into a corner, stopped the spray, went out and followed Sparrow's wet footprints up the ladder.

He was afraid to look back at the snooper above the tunnel door. Jammed in the red. *We've had it, but good*, he thought.

Bonnett was still at the helm as Ramsey entered the control room. "Wouldn't let me help," he said. He motioned toward the door aft.

Ramsey followed the line of wet footprints. *Naked of soul, naked of body*, he thought. *Now we're down to the simplest essentials.*

In the rec room, Sparrow had Garcia stretched out on a cot, a plasma bottle hung above him, its tube leading into a vein. Sparrow was setting up a blood-exchange unit on the opposite side of the cot, adjusting the vein and artery taps, the flow meters, the height of the arm rest.

Ramsey went to the live-blood storage, checked the automatic circulation and re-vitalization systems, found them operative.

"Blood ready," he said. He turned.

Sparrow said, "Right." He plugged the blood-exchange into the live-blood circulating system, put a hand on the valve. "Monitor what we pump out of him."

Ramsey went to the head of the

blood-exchange unit, glanced at the taps which Sparrow had adjusted to Garcia's arm. The engineering officer's breath was coming in slow, shallow rhythm, the movement of his chest barely discernible. The skin of his face and chest had a mottled blue cyanotic appearance.

Sparrow opened the exchange valve. Blood from Garcia's body began to flow into the unit's lead-lined storage system as the new blood was pumped into his body. Immediately, Ramsey's monitor snooper swung far right, stuck there.

"He's off the meter, skipper."

Sparrow nodded. "Shall I use it all?"

"What do you mean?"

"There won't be any blood left for us."

Ramsey's memory flashed back to a vision of the tunnel snooper jammed in the red. "We'll get by with plasma," he said.

"My thought. I'm glad you agree." He came around the cot, unhooked the plasma tube from Garcia's left arm. "If we need it, that is. And I'm more apt to than you are. I was in that tunnel."

"Let's save a couple of changes for you," said Ramsey. "You never can—"

"I'll be all right."

Ramsey fell silent, watching the monitor dial. It stayed against the right-hand pin.

"I got his shots into him and took my own before you came up," said Sparrow. "We'd better check you now."

"Go ahead," said Ramsey. He held out his left arm, kept his gaze on the monitor dial. "Three changes through him by now for sure and he's still off the meter. Skipper, I've never heard of—"

"This is the de-carb," said Sparrow. "It'll hurt." He grasped Ramsey's arm, injected the serum-precipitate into the muscle. "Don't worry about Joe. He's in God's hands, now."

"Aren't we all?" said Ramsey.

"Skipper!" It was Bonnett's voice over the intercom.

Sparrow stepped to a wall mike, flipped the switch. "Go ahead."

"I've just checked out the pile. All secure."

"Set course for Charleston," said Sparrow. "Force speed."

"Aye. How's Joe?"

"It's too soon to know."

"Tell me if—"

"We will." Sparrow closed the switch.

Garcia stirred on the cot; his lips moved and he twisted his head from side to side. Suddenly, he spoke, his voice surprisingly strong. "I've gotta do it, Bea! They'll get at me through our kids! Don't you understand?"

He seemed to be listening.

"I can't tell anybody! They'd shoot me!"

"Easy, Joe," said Sparrow.

Garcia's eyes flickered open, closed, opened. He stared blankly at Sparrow. "Where's Bea? Did they hurt her?"

"She'll be all right," said Sparrow.

Garcia shuddered. "If we could've just gone somewhere and changed our name. That's all." He closed his eyes.

"Do you know where you are?" asked Sparrow.

Garcia nodded. "Nightmare."

"He's on the meter," said Ramsey. "But so far into the probable fatal that—"

"Be quiet," said Sparrow. He checked the change-count dial in the blood system. "Eight down."

"And sixteen to go," said Ramsey.

Sparrow reduced the rate of flow.

"You should've left me in there," said Garcia.

"Don't talk foolish," said Sparrow.

"I was trained in a Buenos Aires spy school," said Garcia. "Twenty years ago. Then I came up here and met Bea. So I quit. Easy. They'd taught me how to hide in plain sight."

"He shouldn't be talking," said Ramsey. "Blood pressure's up."

"Gotta talk," said Garcia. "They found me six months ago, said, 'Come through, or else!' Our kids. Y' understand?"

"Sure, Joe," said Sparrow. "Now, please be quiet. Save your strength."

"First time in my life I ever belonged anywhere—really belonged—was with your crew," said Garcia. "With Bea, sure. But that's different."

"You have to conserve your strength," said Sparrow.

"Why? So Johnny Security can take me back to stand trial?"

"I'm not Security, Joe."

"He's Bu-Psych," said Sparrow. "They put him on to ride herd on me."

Ramsey's mouth dropped open.

"I spotted that the first time we went down over-limit," said Sparrow. "It was the way you treated Les."

"Security, too," said Garcia.

"Only by adoption," said Ramsey. "And I can't—"

"If you spill this," said Sparrow, "I'll—"

"I was about to say that I can't hear so well," said Ramsey. He grinned, then frowned and looked down at Garcia. "Did you have anything to do with the death of that Security inspector?"

"Nothing, so help me God," said Garcia.

"How about the sabotage?"

"My old friends just being doubly sure." He shook his head. "I was just supposed to tip off the location of the well when we reached it. Instead, I set off that spybeam while we were still in our own waters. Thought they'd just force us up—capture us."

"How'd you do it?" asked Sparrow.

"By stepping up the sono-pulse system keyed to that weak tube plate."

"When did you decide not to give



away the well's location?" asked Sparrow.

"I never decided *to* do it."

Sparrow seemed to relax.

"I told Bea to take our kids and go to Security as soon as we were out of pursuit range with the *Ram*." He fell silent.

"Try to rest," said Sparrow.

Garcia sniffed. "What's the needle say now, Johnny?"

Ramsey looked at Sparrow, who nodded assent.

"P-F," said Ramsey.

"Probable fatal," translated Garcia.

"The needle has come down some," said Ramsey.

"Do you want to chance an overdose of de-phos and de-cals?" asked Sparrow.

Garcia looked up at him. "Carry on the jolly battle a little longer, eh?" He smiled. "If you say so, skipper. But keep me under morph, will you?" His grin became tight, like a death's head. "Convulsions are so messy!"

Sparrow took a deep breath, hesitated.

"It's his only chance," said Ramsey. "If you can call that a chance."

"All right," said Sparrow. He stepped to the pharmacy rack, readied the shots, returned.

"The morphine," reminded Garcia.

Sparrow held up an ampule.

"Thanks for everything, skipper," said Garcia. "One favor: Will you look after Bea and the kids?"

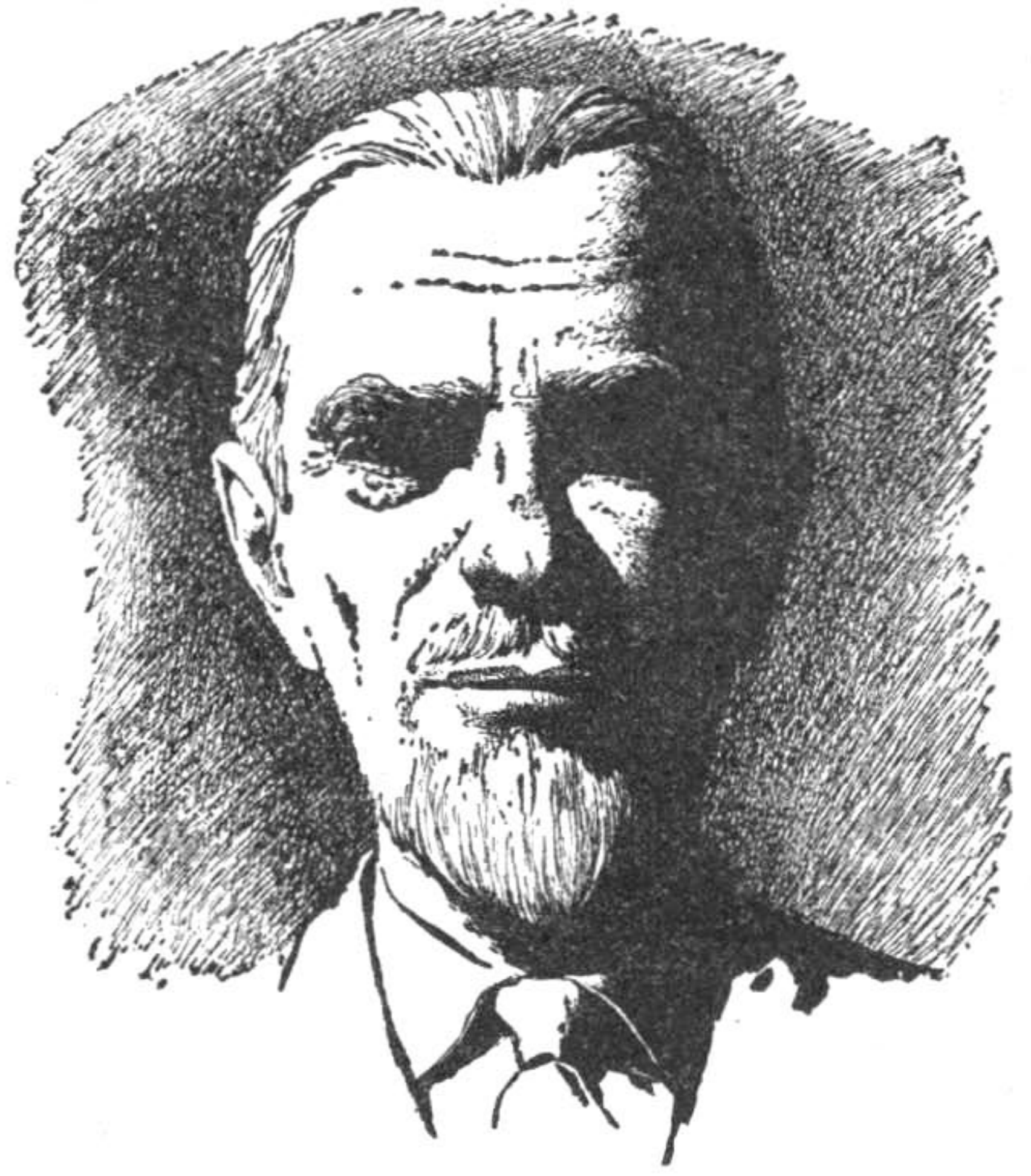

Sparrow nodded curtly, bent and administered the injections one, two, three.

They watched the morphine take effect.

"Eight more blood changes left in the machine," said Ramsey.

"Give him maximum flow rate," said Sparrow.

Ramsey adjusted the valve.

"Now, Johnny, I want the whole story from you," said Sparrow. He spoke without taking his gaze from Garcia.

"Evidently you already know it," said Ramsey.

"Not in detail. That's what I want now."

Ramsey thought, *The cloak and dagger role is a farce. Sparrow's had me spotted for some time—and that's probably Garcia's doing. I've been flying blind and didn't know it. Or*

*did I?* He thought back over his vague feelings of misgiving.

Sparrow said, "Well?"

Stalling for time to think, Ramsey said, "How much detail?"

"Start from the beginning," said Sparrow.

Ramsey mentally crossed his fingers, thought, *This is the crisis. If Sparrow's really psycho, he'll blow. But I have to chance it. I don't know how much he's discovered. I can't pull any punches.*

"You can start right now," said Sparrow. "That's an order."

Ramsey took a deep breath, began with the message from Dr. Oberhausen and the conference with Admiral Belland in Sec-I.

"This telemetering equipment," said Sparrow. "What does it tell you about me?"

"That you're like a part of this submarine. You react like one of its instruments instead of like a human being."

"I'm a machine?"

"If you want."

"Are you sure of your little black box?"

"The body's own juices don't lie."

"I suppose they don't. But interpretations can be mistaken. For instance, I don't think you've correctly evaluated the adjustment we have to make to exist down here in the deeps."

"How do you mean?"

"Do you recall the day you broke down in the shack?"

Ramsey remembered his fear, his

inability to move, the reassuring influence of Sparrow. He nodded.

"What would you call that experience?"

"A temporary psychotic break."

"Temporary?"

Ramsey stared at Sparrow. "What's that supposed to mean?"

"Would you say that all of your actions aboard the *Ram* have been completely sane?"

Ramsey colored, feeling the hot flush of blood in his face. "What kind of a machine are you now, skipper?"

"A computing machine," said Sparrow. "Now listen to me and listen carefully. Here in the subtugs, we have adapted to about as great a mental pressure as human beings can take and still remain operative. We have *adapted*. Some to a greater degree than others. Some one way and some another. But whatever the method of adaptation, there's this fact about it which remains always the same: viewed in the light of people who exist under lesser pressures, our adaptation is not sane."

"How do you know?"

"I've had to know," said Sparrow. "As you've observed, my particular adaptation has been machine-like. Considered in the light of human normality, you psych people have a name for that adaptation."

"Schizoid."

"So I've compartmentalized my life," said Sparrow. "I have a part of me—call it a circuit if you want—which keeps me going down here."

It believes in the hereafter because it has to—”

Ramsey caught the third-person reference to self; he tensed.

“Who’s to deny me the right to be whatever I have to be down here?” asked Sparrow. He rubbed the side of his jaw with his long-fingered hand. “I had to know what it was I was doing. So I studied me. I analyzed me. I computed me against every background I could think of. I was completely ruthless with me.” He fell silent.

Cautiously, Ramsey said, “And?”

“I’m nuts,” said Sparrow. “But I’m nuts in a way which fits me perfectly to my world. That makes my world nuts and me normal. Not sane. Normal. Adapted.”

“You’re saying the world’s schizoid, fragmented.”

“Hasn’t it always been?” asked Sparrow. “Where are there completely unbroken lines of communication? Show me complete social integration.” He shook his long head from side to side in a slow negation. “It’s the pressure, Johnny.”

Ramsey made a minute adjustment on the flow meter controlling the exchange of blood in Garcia’s body. He looked down at the drugged engineering officer. Face relaxed, peaceful. Pressures gone for the moment.

“We look to a Utopian existence as sanity,” said Sparrow. “No pressures against survival. That’s why we get a dreamy, nostalgia about us when we think of the old South

Seas. Minimum threat to survival.” Again he shook his head. “Whatever the pressure and whatever the adaptation, that adaptation is definable by your science as non-sane. I sometimes think that’s the proper interpretation of the Biblical phrase: ‘A child shall guide them.’ Children generally don’t have survival pressures. Ergo: they’re more sane than adults.”

“They have their pressures,” said Ramsey.

“Of a different character,” said Sparrow. He bent, felt Garcia’s pulse. “How many changes left?”

“Two.”

“What’s the radiation reading?”

Ramsey’s head jerked as he turned to stare fully at the dial. “Fifty-fifty.”

“He’ll live,” said Sparrow. His voice carried a tone of absolute decision, an irrevocable judgment.

Ramsey fought down an unaccountable irritation. “How can you be so sure?”

“You were startled when you focused on the meter,” said Sparrow.

“It’s a miracle he’s come this far.” In spite of himself, Ramsey’s voice betrayed his irritation.

“That’s right, a miracle,” said Sparrow. “Listen to me, Johnny. In spite of all your science and your medicine, there’s something you people often refuse to admit.”

“Which is?” Now his voice was openly hostile.

“There’s such a thing as being on God’s side. Being right with the world. That’s really the thing be-

hind miracles. It's quite simple. You get in . . . well, phase. That's the mechanical way of saying it. You ride the wave instead of bucking it." Sparrow's voice carried a tone of calm detachment.

Ramsey pressed his lips together to keep from speaking his thoughts. And over it all, his own psychological training was feeding data to a train of thought: *Religious fanaticism. Fragmentation. Impenetrable belief in own righteousness. The evidence for a diagnosis of paranoid type is very strong.*

"Your particular adaptation is dictated by your psychological training," said Sparrow. "You have a function: to keep me operating. Call it normal. You have to believe I'm insane and that your diagnosis of insanity type is accurate. That way, you're on top; you're in control. It's your way to survival. You can guide me and direct me like the proper animal that I am, and I'll take you back where the pressures are reduced."

"This is nonsense!" barked Ramsey. "Psychological nonsense! You don't know what you're talking about!"

"If your diagnosis is correct, what's the probable course of my life?" asked Sparrow.

Before he could stop himself, Ramsey said, "You'll go completely psychotic! Completely—" He broke off.

Sparrow laughed. He shook his head. "No, Johnny. I'll go back where the pressures are less. And I'll take a deep breath. And I'll

play a little poker at Garden Glenn. And I'll get drunk a time or two because it's expected of me. I'll have another honeymoon with my wife.

"And, of course, I'll do some more wondering: What's this all about? What are we human animals? What's the meaning behind all this? If there is a meaning. But my roots are solid, Johnny. I've seen miracles." He nodded toward Garcia. "I've known the outcome of events before even the events. That gives me a—"

The warning buzzer sounded on the blood-exchange unit. Ramsey slapped the transfer switch. Sparrow moved around the cot, disengaged the artery and vein taps.

"Sixty-forty," said Ramsey.

"We'll be at Charleston in twenty-two hours," said Sparrow. He looked at Ramsey. "What do you intend to tell Admiral Belland's boys about Joe?"

"I don't remember anything about Joe worth telling Belland," said Ramsey.

A slow smile formed on Sparrow's lips. "That's normal," he said. "Not sane, but normal."

Ramsey sniffed. *Why am I irritated?* he asked himself. And his psychological training gave him the unavoidable answer: *Because I'm not facing something about myself. There's something I don't want to see.*

"Let's talk about Heppner," said Sparrow.

Ramsey suppressed an urge to shout, "*What for?*"

"He got to wondering about sanity," continued Sparrow. "And one day the truth dawned on him that I'm not particularly sane. Then he got to wondering: What is sanity? He talked about some of his thoughts. And he found he couldn't define sanity. Not for sure. Which meant to him that he himself was off balance." Sparrow closed his eyes.

"So?" whispered Ramsey.

"So he applied for a transfer out of the subtugs. He gave me the application to submit when we landed. That last trip."

Ramsey said, "He cast himself adrift."

Sparrow nodded. "And he'd already admitted to himself that he had no anchor, no point of reference from which to navigate."

Ramsey felt a curious internal stimulation, as though he were on the brink of a great revelation.

"And that," said Sparrow, "is why I have to train another new electronics officer. You have to go back to Bu-Psych where you have your roots. That's an ocean in which you can navigate."

Ramsey could contain the question no longer. "What's your definition of sanity, skipper?"

"The ability to swim," said Sparrow.

Ramsey felt a cold shock, as though he had been immersed suddenly in freezing water. He had to force himself to continue breathing normally. As though from a great distance, he heard Sparrow's voice:

"That means the sane person has

to understand *currents*, has to know what's required in different waters."

Ramsey heard a heavy thundering, counterpoint to Sparrow's matter-of-fact tones.

"Insanity is something like drowning," said Sparrow. "You go under; you flounder without direction; you—Johnny! What's wrong?"

He heard the words, but they lacked meaning: The room was a spinning centrifuge with himself at the rim . . . faster . . . faster . . . faster— He caught at the blood-exchange unit, missed, crashed to the floor. A detached part of him sensed hands on his face, a finger lifting an eyelid.

Sparrow's voice squeaked insanely down an inverted funnel: "Shock!"

*Tbud! Tbud! Tbud! Tbud!*

Footsteps

Slamming of cabinet door

Clinking of glass

He floated in a gelatin hammock, bound in upon himself. A miniature stage opened before his eyes. Sparrow, Garcia and Bonnett stood arm in arm, doll figures staring across Lilliputian footlights.

Puppets.

In a dull monotone, the miniature Sparrow said, "I am a Commander, Submarine, Portable, Mark I."

The miniature Garcia said, "I am an Engineering Officer, Submarine, Portable, Mark I."

The miniature Bonnett said, "I am a First Officer, Submarine, Portable, Mark I."

Ramsey tried to speak, but his lips would not respond.

On the doll stage, Sparrow said, "I am not sane; he is not sane; you are not sane; we are not sane; they are not sane."

Garcia said, "I regret to report the failure of a component: myself." He dissolved, leaving Sparrow and Bonnett separated by a space.

Bonnett said, "That Ramsey is a catalyst."

Sparrow said, "I cannot help you; he cannot help you; we cannot help you; they cannot help you; you cannot help yourself."

Garcia's voice came from the empty space: "I regret that I cannot thank you in person."

Bonnett said, "My generation doesn't believe in vampires."

Again Ramsey tried to speak, but no sound came.

In unison, Sparrow and Bonnett began to recite: "Be quiet . . . be quiet . . . be quiet . . . be quiet . . . be quiet—"

Fainter.

Fainter.

Fainter.

Garcia's voice was an echo, slightly off beat.

Deep enfolding darkness.

An amniotic darkness.

Ramsey felt movement, a humming: the motors. Bonnett's voice: "I think he's coming around."

Sparrow: "Can you hear me, Johnny?"

He didn't want to answer. That would take energy. It would give substance to the world. His years of psychological training abruptly said

to him: *You are in a tight foetal position!*

Sparrow: "Let's try to straighten him out. That may help."

Bonnett: "Break it to him gently, skipper."

Hands touched his legs, his arms, pulling him from the curled ball. He wanted to resist, but his muscles felt like weak putty.

*Break what gently?*

Sparrow's voice was imperative: "Johnny!"

Ramsey wet his dry lips with a reluctant tongue. *Break what gently?* His voice came out faintly: "Yeah?"

"Open your eyes, Johnny."

He obeyed, looked straight up into a cross-hatch of pipes and conduits. Control room. He sensed Sparrow beside him, turned. The skipper looked down at him, a worried frown tensing the long face. Beyond him, Bonnett stood at the controls, back to them.

"Wha's— Wha's—" He tried to clear his throat.

Sparrow said, "We brought you in here where we could keep an eye on you. We're almost at Charleston."

Ramsey sensed the life-pulse of subtug around him, sank into it momentarily. *Break what gently?* He said, "What happened?"

"You reacted to something," said Sparrow. "Maybe the de-calcification shot. It may have had something to do with our over-pressure dives, increased anhydrase. How do you feel?"

"Lousy. How's Joe?"

Sparrow seemed to retreat within himself. He took a deep breath. "Joe ran out of red cells. Nothing we could do."

*And there went your miracle,* thought Ramsey. He said, "I'm sorry, skipper."

Sparrow passed a hand over his eyes. "Perhaps it was for the best." He shrugged. "He was too—"

"I have something on the ranging scope," said Bonnett. He keyed the IFF circuits, tested them. "It's a Monitor. One of ours. Coming fast."

Sparrow whirled, went to the communications board, tested the relays from the shack. "Are we close enough for voice?"

Bonnett studied his instruments. "Yes."

Sparrow turned a rheostat, closed the microphone key. "This is Able John. Repeat. This is Able John. We have a full slug. One crewman down with radiation sickness. Request clearance for Charleston. Over."

A voice came from the wall speaker with the eerie wavering of pulse modulation over its surf-hiss of background noise. "Hello, Able John. You're a bit hot. Stand by for snooping. Over."

Bonnett depressed the drive bar and their speed slackened.

From his position on the cot, Ramsey could see the ranging scope, blip lines growing deeper and deeper as the Monitor approached.

Again the eerie voice wavered from the speaker. "Monitor to Able

John. You'll pass, Able John. Proceed at entrance depth. We will flank you. Over."

Bonnett pulled up the drive bar. The *Ram* surged ahead.

"Give us the bow eyes," said Sparrow.

The big screen above the searchboard came to life. Green water and occasional kelp.

Sparrow turned toward Ramsey. "We'll have you in good hands soon, Johnny. Before you know it."

Ramsey felt a strange dragging at his senses. He tried to imagine the Charleston tunnel entrance—a black hole in the wall of an underwater canyon. His mind sheered away. *Why was that?* he asked himself. Then, *Break what gently?* Part of him seemed to be standing off, making clinical notes. *You don't want to go back. Why? A bit ago you were in a rolled up ball. Remember? Very interesting.*

He sensed an answer, said, "Skipper."

"Yes, Johnny?"

"I went catatonic, didn't I? Catatonic shock?"

Sparrow's voice became brisk. "Just shock."

The tone told Ramsey what he wanted to know. The clinical part of his mind said, *Catatonic. Well, well.* He was suddenly very aware of the cot beneath him, pressure of his own weight against his back. In the same instant, pieces of his puzzle started clicking into place. He took a deep breath.

"Just take it easy," said Sparrow.

Bonnett glanced back, a look of wariness about his eyes.

"I'm all right," said Ramsey. And he was surprised at the full extent of truth in that statement. Strength was pouring into him. "I went into a full retreat," he said. "But now I know why."

Sparrow stepped to the side of the cot, put the back of his hand against Ramsey's forehead. "You should try to relax."

Ramsey repressed an urge to laugh. "Joe told me, skipper, but I didn't believe him."

Sparrow's reply was little more than a whisper: "What did Joe tell you?"

"That you've had this situation pegged and under control all along." He nodded. "That marine tunnel's a birth canal. Going through it is like being born. This sub is a perambulating womb looking for a place to spew us out."

Sparrow said, "Maybe you hadn't better talk now."

"I want to talk. We're born into another set of realities. There's one kind of insanity down here; another up there. Just look at the old *Ram* here. An enveloped world with its own special ecology. Damp atmosphere, ever-present menace from the outside, a constant rhythmic motion—"

"Like a heartbeat," said Sparrow quietly.

Ramsey smiled. "We're afloat in amniotic fluid."

"How's that?"

"Salt water. It's chemically almost

identical with the fluid surrounding an unborn baby. The unconscious knows. And here we are headed for birth."

"You make a more detailed comparison than I ever have," said Sparrow. "What's our umbilical cord?"

"Experience. The kind of experience that ties you to your ship, makes you a part of it. Petite perception. You're the perfect symbiote. We become syblings, brothers, with all the emotional ties and rivalry that—"

"First check point," said Bonnett flatly. "Now on heading for the Charleston mole. Do you want to take over, skipper?"

"Take her in, Les," said Sparrow. "You've earned the right."

Bonnett reached up, adjusted the range-response dial. His shoulders seemed to take on a new, more positive set. Ramsey realized abruptly that Bonnett had come of age on this voyage, that he was ready to cut his own cord. The thought gave Ramsey a tug of possessive fondness for Bonnett, an emotion touched by nostalgia at the thought of separation.

*Truly like brothers*, he thought.

Sparrow looked down at Ramsey. "Why don't you transfer out of Bu-Psych and into the subtugs?" asked Sparrow.

"Yeah?" echoed Bonnett. "We need good men."

Sadness tightened Ramsey's chest. "That's the finest compliment I've ever received," he said. "But I can't. I was sent out here to solve a prob-



lem: Why were submariners breaking down? You gave me the answer. Now, I'll have to take a hand in applying that answer." He swallowed a lump in his throat. "Dr. Oberhausen of Bu-Psych has promised me my own department dealing with problems of submariners."

Sparrow said, "That's wonderful, Johnny! A big-time shore job."

"We're going to hate losing you," said Bonnett. "Will you still talk to the likes of us when you're an important brass type?"

"Never fear," said Ramsey.

"What is this solution?" asked Sparrow.

"The breakdowns are a rejection of birth by men who have unconsciously retreated into the world of pre-birth. What child would seek birth if he knew that pain and fear—a constant menace—awaited him on the other side?"

"There's menace down here," said Sparrow.

"But our little world under the sea fools and confuses the unconscious," said Ramsey.

Bonnett spoke up, a faint note of sarcasm in his voice. "That makes sense even to me . . . I think." He kept one hand on the wheel, stepped aside to adjust the tow controls.

"We have to make the complete cycle desirable," said Ramsey. "I'm going to recommend a whole new procedure: the best quarters for submariners. A big jump in pay for each mission."

"That's for me!" said Bonnett.

"There are going to be some changes made," said Ramsey.

"Johnny, do me a favor," said Sparrow.

"Name it."

Sparrow looked away, swallowed. "It sounds like you're going to be a VIP and—" He hesitated. "Will you do what you can to cushion things for Joe's wife?"

"Anything I can do," said Ramsey. "I promise." He took a deep breath. "Who's going to get the dirty job of telling her?"

"I will," said Sparrow. "I'll break it to her as gently as I can."

A sudden chill swept over Ramsey's body. *Break it gently!* He cleared his throat. "Skipper, that reminds me. I heard Les say something about breaking a bit of news to me. What?"

Sparrow wet his lips with his tongue, looked across at Bonnett working with the controls.

"Break what gently?" repeated Ramsey.

"Joe's death."

"But—"

"Each time we tried to bring you out of shock, you—"

"Each time?"

"We tried four or five times. Each time you raved for Joe to come back. We guessed it was delirium, but—"

Silence fell between them.

"The unconscious senses many things," said Ramsey. He felt a deep emptiness, and suddenly recalled his nightmare, Garcia's voice: "*I regret that I cannot thank you in person.*"

*For what?*



Ramsey said, "We had a lot in common. Joe understood me. He saw right through my act . . . said so. I guess I resented it. Joe was better at my game than I was."

"He admired you," said Sparrow.

Ramsey's eyes burned and smarted.

"He was awake at the end," said Sparrow. "Worried about you. He said he'd given you a raw deal by feeding our suspicions. Joe thought you had the makings of a top submariner."

Ramsey turned away.

"Will you do what you can for his wife?" asked Sparrow.

Ramsey nodded, unable to speak.

"We're approaching the mole," said Bonnett, his voice oddly casual. "Bottom marker number two coming up." He indicated the screen above him.

Through a green haze of water, two high-piercement lights keyed to their IFF circuits winked at them.

"Are we set for the automatic pick-up?" asked Sparrow.

"All set," said Bonnett.

"We've brought home the bacon," said Ramsey.

Bonnett's voice took on an unconscious mimicry of Garcia's bantering accent: "We're a bunch of bloody heroes!"

Sparrow looked at the timelog. "A biblical voyage," he said. "We've been out forty days, seven hours, twenty-four minutes."

It was peaceful in Dr. Oberhausen's Charleston office. The wizened Bu-Psych chief sat behind a desk like

**ASTOUNDING SCIENCE FICTION**

all other Bu-Psych office desks, leaning back with his hands steepled beneath his goatee. His bat-eye radar box, disconnected from its shoulder harness, rested on the patterned wood of the desk top. Dr. Oberhausen's sightless ball-bearing eyes seemed to be staring at Ramsey, who sat across the desk from him.

Ramsey rubbed a hand over his head, feeling the stubble of returning hair. "That's pretty much the story," he said. "Most of it was in my notes. You've had those, even though the medics wouldn't let you talk to me."

Dr. Oberhausen nodded silently.

Ramsey leaned back in his chair. It creaked and he suddenly realized that Dr. Oberhausen purposely surrounded himself with creaking chairs—reassuring signals for a blind man.

"A close thing with you, Johnny. Radiation sickness is a peculiar matter." He passed a hand across his own radiation-blinded eyes. "It is fortunate that Bu-Psych agents are virtually indestructible."

"Does this check with my notes and the telemeter tapes?" asked Ramsey.

Dr. Oberhausen nodded. "Yes, it checks. Sparrow became almost literally a part of his ship, sensitive to everything about it—including his crew. An odd mating of the right mentality and the right experiences has made him a master psychologist. I'm going to see about taking him into the department."

"What about my recommendation for preventing those psychotic breaks?"

Dr. Oberhausen pursed his lips, tugged at his goatee. "The old Napoleonic fancy-uniform therapy: fanfare coming and going." He nodded. "Security will kick and scream that it will prevent secrecy of departures, but they've already made one concession."

"What?"

"They've announced officially that we're pirating oil from the EPs."

"That was a senseless secret anyway."

"They were still reluctant."

"We'd be better off without Security," muttered Ramsey. "We should be working to get rid of it. Security stifles communication. It's creating social schizophrenia."

Dr. Oberhausen gave a negative shake of his head. "No, Johnny, we shouldn't get rid of Security. That's an old fallacy. Use Captain Sparrow's analogy: In an insane society, a crazy man is normal. Security has the kind of insanity that's normal for wartime. Normal and needed."

"But *after* the war, Obe! You know they're going to keep right on!"

"They'll try, Johnny. But by that time we'll have Security under the control of Bu-Psych. We'll be able to nullify them quite effectively."

Ramsey stared at him, then chuckled. "So that's why you've been moving in on Belland."

"Not just Belland, Johnny."

"You scare me sometimes, Obe."

Dr. Oberhausen's goatee twitched. "Good. That means my pose of omnipotence is effective even with

those who know better." He smiled.

Ramsey grinned, stirred in his chair. "If that's all, Obe, I'd like to get away. They wouldn't let Janet and the kids anywhere near me while I was in the hospital, and now that—"

"I waited, too, Johnny. Bu-Med's little dictatorship halted even the great Bu-Psych. There's an area of autonomy in radiation medicine that—" He shook his head slowly.

"Well?" asked Ramsey.

"The impatience of youth," said Dr. Oberhausen. "There are just a few more points to be cleared up. Why do you believe we never saw the need for this fancy-uniform therapy?"

"Partly Security," said Ramsey. "But it really wasn't obvious. Wrong symptoms. Napoleon was looking to build up enlistments and stop his gunners from going over the hill. We've never had that trouble. In fact, our submariners seemed eager to return to duty. That's the paradox: they found threat in both spheres—ashore and at sea. When they were ashore they seemed to forget about the menace of the sea because the subconscious masked it. The ship spelled enveloping safety, a return to the womb. But when the men came ashore, that was birth: exposure. The sky's a hideous thing to men who want to hide from it."

Dr. Oberhausen cleared his throat. His voice took on a crisp, business-like tone. "Now, I'd like to go back to your notes for just a moment.

You say Bu-Psych should emphasize religious training. Explain your reasoning."

Ramsey leaned forward and the telltale chair creaked. "Because it's sanity, Obe. That's the—"

"It smacks of a panacea, Johnny. A nostrum."

"No, Obe. A church provides a common bond for people, a clear line of communication." He shook his head. "Unless Bu-Psych can uncover telepathy or absolute proof of the hereafter, it can't substitute for religion. The sooner we face that, the sooner we'll be able to offer—"

Dr. Oberhausen slapped his hand on the desk top. "Religion is not scientific! It's faith!" He said *faith* as he might have said *dirty*.

*He's needling me*, thought Ramsey. He said, "O.K., Obe. All I'm saying is this: We don't have a substitute for religion. But we're offering our so-called science as a substitute. That's all I'm—"

"So-called?"

"How many distinct schools of psychology can you name?"

Dr. Oberhausen smiled thinly. "At least as many as there are distinct religions."

"We're following the pattern even there," said Ramsey.

The Bu-Psych chief chuckled. "Did I interrupt a chain of thought?"

Ramsey paused. "Only that I've never met a psychoanalyst who did not—at least subconsciously—offer his system as a substitute for religion. Present company included. We

set ourselves up as little gods—all-knowing, all-healing. People resent that and rightly. We have polite labels for our failures. We agree among ourselves that anything bearing one of those labels is, of course, incurable.”

Dr. Oberhausen’s voice held a sense of remoteness. “That’s quite an indictment, Johnny. Do I take it that you’ve been *converted* by our good Captain Sparrow?”

Ramsey leaned back, laughed. “Hell, no! I’m just going to stop posing as a messiah.”

Dr. Oberhausen took a deep breath. “That’s encouraging.”

“And I guess I’ll go on poking around inside people’s minds.” He smiled. “If that describes whatever it is we do, I’ll keep on being a psychologist.”

“What do you expect to find?”

Ramsey was silent a moment, then: “A good scientist doesn’t *expect* to find anything, Obe. He reports what he sees.”

Dr. Oberhausen clasped his hands. “If you find God, please let me know.”

“I’ll do that.” Ramsey forced briskness into his voice. “As long as we’re clearing up loose ends, what about me? When do I get out of this uniform and into my nice new department of Bu-Psych?”

Dr. Oberhausen pushed his chair back, resting his hands on the edge of the desk. He tipped his head down, appeared to be staring at the bat-eye box. “First, you’ll have to play out your hero role. The Presi-

dent’s going to pin medals on all of you. That’s Belland’s doing. By the way, the admiral has given Mrs. Garcia a job in his department, his polite way of keeping her under surveillance. But it works out for the best of all concerned.”

“In this best of all possible worlds,” said Ramsey. He sensed hesitancy in Dr. Oberhausen’s manner. “But when *do* I get out of the service?”

Dr. Oberhausen lifted his chin. “I may not be able to get you out immediately, Johnny.”

Ramsey felt pressure building up inside him. “Why?”

“Well, you’re a hero. They’ll want to exploit that.” The Bu-Psych chief cleared his throat. “Some things are difficult even for Bu-Psych. Look, I couldn’t even get past Bu-Med and in to see you while—”

“You promised me a—”

“And I’ll keep my promise, Johnny. In time.” He leaned back. “Meanwhile, there’s a commodore on the board of classification and promotion. He’s a presidential errand boy and he needs an . . . an aide-de-camp.”

“Oh, no!” Ramsey stared at Dr. Oberhausen.

The little doctor shrugged. “Well, Johnny, he found out that you’re the clever Long John Ramsey who improvised a vampire gauge from a hypodermic and two glass tubes and saved the *Dolphin* during that training mission breakdown. He wants—”

Ramsey groaned.

"You'll be jumped to lieutenant," said Dr. Oberhausen.

"Thanks," said Ramsey bitterly. He curled his lips, copied Dr. Oberhausen's voice: "Sure, Johnny. You'll have your own department."

"You're young," said Dr. Oberhausen. "There's time."

"He'll have me polishing his shoes."

"Oh, no. He's quite impressed by your talents. Says you're too good for Bu-Psych. You have 'creative' imagination. Bringing home that oil has done nothing to reduce his admiration. He credits you for this deep-dive maneuver." Again the Bu-Psych chief cleared his throat. "And while you're with the commodore, there are some things about his department that I'd like you to—"

"So that's it!" barked Ramsey. "Another of your spy jobs! You want me to ferret out the dope on the commodore so you can move in on him. I'll bet you set this job up yourself."

"I'm sure you see the necessity," said Dr. Oberhausen. "That way lies sanity."

"I'm not so sure," said Ramsey.

"I like your Captain Sparrow's analogy about sanity and swimming," said Dr. Oberhausen. "But I would add to it, the swimmer must be prepared at all times to grasp a paddle."

Ramsey smiled even as he realized that Dr. Oberhausen was amusing him to ease the tension between

them. "O.K., Obe. One more. But I'm telling you now: That's all."

"Fair enough, Johnny. Now, if you'll just—"

A door slammed in the outer hall behind Ramsey. He heard a flurry of sounds. A woman's voice shouted: "You can't stop me from going in there!"

*Janet!*

His pulse quickened.

The woman's voice mounted almost to a scream: "I know he's in there with Dr. Oberhausen! And I'm going in!"

The office door behind Ramsey burst open. He turned. It was a secretary. "Please excuse me," she said. "There's—"

"Let her come in," said Dr. Oberhausen.

Ramsey stood up, feeling suddenly giddy. Janet came rushing through the door and into his arms. A familiar perfume. The contours of a familiar face pressing against his cheek, a familiar body against his own.

"Johnny! Oh, Johnny!"

He heard Dr. Oberhausen get up, saw him walk past them toward the office door, fastening the bat-eye box to his shoulder as he went.

"Johnny, I missed you so."

"I missed you, too," he said.

"I never knew it would be so dangerous. Why, they told me—"

"It wasn't bad, Janet. Really."

"But you were so long in the hospital!"

Dr. Oberhausen paused at the door, a figure seen in new perspec-

tive, grown suddenly smaller, giving off a sense of loneliness. Ramsey wanted to call out something, but didn't know what. He said, "Obe."

The Bu-Psych chief turned.

"We'll see you soon," said Ramsey.

The doctor smiled, nodded, went out, closing the door behind him.

And then Ramsey had to explain to Janet why he wanted to include "that awful old Obe" in their reunion plans.

THE END

## IN TIMES TO COME

The lead story next issue is to be "Double Star," by Robert A. Heinlein—who hasn't been appearing in these pages as often, by a long shot, as we'd like. But this will be Part I of a three-parter. The piece starts off simply enough; just an actor called on to play a role temporarily. But what happens when an actor—a real, deep-down, all-out actor—is called on to play a role that's bigger than he *thinks* he is . . . ?

Also present will be a lovely item by Mark Clifton, called "Clerical Error," in which a psychiatrist of unusual wisdom and perspicacity commits himself to his own hospital, for most excellent reasons. Trying to outline the plot of this one, my friends, will lead to a cross-eyed double-talk inversion that would convince your friends you belonged in the said hospital. It's a lulu!

THE EDITOR.

# LABOR OF LOVE

*There's a basic difference in the method of thinking we of today use as against that used a millennium or more ago. It's remarkably hard to spot—because we assume that, of course, everybody always thought this way, didn't they...*

BY MURRAY LEINSTER

In matters of the intellect it is, nowadays, the fashion to feel a sort of kindly contempt for one's father, rather more impatience of one's grandfather, and mere derisive amusement at all the quaint notions of the generations before them. At the same time, we say that the Greeks had a word for nearly everything, and we patronizingly wonder why the gabby old philosophers could think so clearly and impress our parents as so smart, and never arrive at real intellectual triumphs like indoor plumbing and television commercials. We may even say patronizingly:

"The ancients had a splendid  
stoa

But not an airline to Samoa."

(*"Phooey to the Age of  
Pericles,"* Leinster.)

The amazement we express when we bother to think about it has a certain amount of justification. But not much. The same antique characters who concocted mathematics, astronomy and discovered logic; who invented the drama and the musical scale we use when we play the "Smorgasbord Mambo"; who developed politics, obfuscation and graft into fine arts and thought serenely and with ten times the clarity we do— Those same old chaps paid absolutely no attention to nuclear physics, biology, chemistry, or any of the applied sciences of modern civilization.

Of course we pay as little attention as possible to mathematics, astronomy, or logic, though we're pretty good at politics and obfuscation and graft. We do not think serenely or with clarity, but we're



hell on quick-freeze and gasoline additives. And in consequence we feel superior.

But I had a shock some time ago. I came across a quotation in Roger Bacon (1214-1294 A.D.) from one Alain of something-or-other and of the Eleventh Century. Old Rogeris Baconi was discussing the shape of all the things that are, and including all time and space in his deliberations. So he approved of Alain's description. "*The totality of being,*" said Alain, and one may simply read "*the cosmos*" for that phrase. "*The totality of being is a perfect sphere, whose periphery is imaginary and whose center is everywhere.*" I commend it to your attention. It is a fully intended description of a time-space continuum, made some nine centuries ago. In a sense it is science at its highest level, where philosophy and science happen to become the same thing. And as our friend George Gobel would remark, "You can't hardly get that no more."

It gave me to think. I began to remember some more items. There was old Ptolomy, whose astronomy we dismiss these past few centuries with bland contempt. But the old fellow wasn't really as stupid as some of us think. His physical assumptions were wrong, of course, like the assumptions behind engineering equations which have to have bugger factors put in to make the answers come out right. But his tables worked, for the practical scientific purpose of predicting where the planets would be at given times

in the future. The resemblance to everyday scientific computation, here, is very strong. We could use Ptolomy's cycles and epicycles right now for aiming our backyard telescopes, and they'd work out pretty well. I'm aware that he didn't know all the facts about the solar system, but if you think we know all the facts about the things we work with—ask a nuclear physicist!

Some very, very remote old persons arrived at some very bright results. Our ancestors were at least as smart as we are. The worst that can be said against their intelligence is that they became our ancestors. Otherwise their brains simply can't be questioned. But nevertheless, in a relatively short time, recently, we have accomplished things our forbears didn't even approach. They must have thought differently.

They did. Most of them, anyhow. In a little while I propose to talk about the difference between classic and modern habits of thought. There is just one little gimmick they shied away from, which is the reason they stuck to gab while we have gone on to gadgets. It's a rather important gimmick. But there are a couple of things to be mentioned first.

Actually, there are three. One is that the physical sciences are often dependent on apparatus developed in wildly unrelated fields. For instance, a good two hundred fifty years before Pasteur, one Augustus Hauptman and also one Christian Langius reasoned that syphillis must

be caused by "little nimble, brisk invisible things which . . . increase and multiply in Abundance" (and) "occasion all the symptoms that occur." Even before them one Athanasius Kircher, a Jesuit, and John Saguens, a Minim, declared that the Plague (Black Death, bubonic plague) must be caused by "invisible living things swimming in the blood," and it was clearly recognized that if proof of such a thing could be found "the whole Theory of Medicine would fall to the Ground, as nothing could be said to prove the"—the quotation here refers to the idea that pathogenic microorganisms were the cause of syphilis—"Venereal Disease depending upon little living things, which might not be urged to prove that all other Diseases were derived from the like little living things though of a different Species . . ." And the account from which this is quoted, by one John Astruc, physician to Louis XIV of France, ends scornfully, "than which nothing could be more absurd!"

Nowadays it does not seem absurd. But at the time the science of optics and the art of glass-manufacture were not as well developed as the art of logical inference and the science of thinking. There were no microscopes. Therefore there could be no proof of the existence of creatures of which by pure reason it could be said that they led "frequent Colonies to different Parts of the Body: and inflame, erode, and exulcerate the Parts they fix on . . ."

There were brains at work. It is quaint to reflect that germs could be reasoned out, as the bending of light at the sun's limb was reasoned out by Einstein. But it took two and a half centuries for the technical means of research to catch up with the early biologists, while instruments to test Einstein's notion were available almost at once. It is fair to say that not all the failures of the old-timers were due to the men who did the heavy thinking. There were handicaps.

But the second thing to be mentioned is that a lot of those handicaps still exist. People of previous generations were very much like us. Right now it is orthodox to consider that the universe is expanding furiously. The opinion has eminent authority behind it. To question it is to be a crackpot. But the reasons against it seem overwhelming to some people, including me. And we who do not accept the cosmological theory of the expanding universe are scorned as violently as people used to be scorned for questioning the medical theories of Galen and Hippocrates. "Authority" is as weighty now as ever.

Conversely, not only are the authoritative as scornful as of yore, but innovators are quite as whacky. I know a man whom I believe has made a discovery in physics. It isn't earth-shaking, but it looks valid. His work is ignored—because his real purpose in life is not to discover anything, but to make a more eminent man out a faker. He wants to

build himself up by tearing somebody else down. It shows! (And he made one experiment he considered against his theory, and he suppressed it.) Naturally nobody takes his real evidence seriously.

In olden days everybody revered authority and scorned those who differed from the big shots. It's still true. And in olden days people went after personal ends instead of the advancement of science. That hasn't changed, either. It's too bad!

My third point is that in the really ancient days it was considered disreputable to do any thinking or any research that might have disturbing consequences. Right now, try to picture what would happen in Russia if somebody came up with incontrovertible proof that private enterprise would produce more food on the farms and more goods in the factories. How long would he live and how widely would his results be published? You guess!

This has always been, and probably always will be. There are people all around us today who deplore the whole science of nuclear physics. Their reasoning is the same as that of the people a hundred-odd years ago—at the beginning of the Industrial Revolution — who went around burning down factories. All changes, all novelties, are alarming to a certain type of people. There used to be even more of them in ancient times. Then the nation and the social system was always considered perfect since last Tuesday. Philosophers in classic Greece and

ancient Rome knew it. They took no chances. To offer to change things in any way would seem like shooting Santa Claus. They didn't offer. Socrates? He was executed for encouraging the young to think, which might lead to anything! (It has. But at that Socrates must have been one of the most infuriating people who ever lived. It's hard to blame the people who poisoned him!)

The death of Socrates, however, did not mean that the Athenians minded people thinking for themselves. They objected only to Socrates' efforts to make it a national custom. They insisted that thinking remain mere thought—a pastime—that there be no damned zeal about it. And the position can be defended. We have changed our attitude toward what we used to call "parlor pinks." We changed because we found them conspiring to make us do what they wanted us to, instead of as we pleased. If the philosophers of ancient Greece had formed a Stoic Party and plotted to grab the government and make everybody live as stoics, the Greek states would have slapped them down, too. And properly! Nobody has the right to make anybody else act like a crackpot. Being a crackpot should be a labor of love.

That's the last of my preliminary points. I regard them with disturbed surprise. I should have thought of them years ago. I think they're true.

And if they are true, they are

reasons why science didn't develop earlier. Our ancestors had all the brains we have, but they didn't use them as we use ours. They were cagey. The germ-theory business is late, relatively. Men had the nerve to think, then, even if they didn't have microscopes and laboratory-culture apparatus to check their thinking with. But the ancients never risked thinking about anything that could be verified and might start something. Why are we so much more adventurous? It really looks like we think in some fashion they avoided. But what fashion? And why?

Let's dig around a while and see. Of course we are all rational creatures, and sometimes we even think rationally. And rational thinking, obviously, is thinking which accords with reality. If our brains were not able to handle reality, they would be as useless as a digestive system that couldn't handle real food. The way we think in our saner moments—the way which handles realities—is called "logical" thinking, and therefore we say that the cosmos is constructed in a logical manner. (Presumptuous, but let it pass.) Anyhow, since we can examine logical thinking we can form a science of rational thought—as of physics or biology or the writing of television soap operas. (Luckily, we don't need a science of digestion or we would unanimously starve to death.)

So we have found out, as did the ancients before us, that we really think in "concepts," which in an-

other respect are ideas, which are the end-product of a process called intellection and we won't start an argument about it. We use concepts in thinking as we use words in talking. And we put concepts together in syllogisms as we put words together in sentences. Everybody does it, and sometimes both the sentences and the syllogisms are pretty sloppy. But most of us don't really notice that we speak in sentences, and practically all of us think in syllogisms without realizing it.

To skip a lot of theory, I'll just say flatly that I think we moderns use a kind of syllogism the ancients knew all about, but that we use it more often than they did, and that everybody, at all times, has thought—in syllogisms—for only three real purposes. We think about things to find out what they are: to find out what we *must* do about them: and to find out what we *can* do with them. The first two processes give intellectual certitude and avoid trouble. The third starts all sorts of things, mostly unpleasant. The ancient thinkers let well enough alone, while we moderns emphasize the third kind of thinking, and modern times and manners are the consequence.

The three kinds of thinking can be nicely illustrated by three syllogisms. Somebody named Aristarchus is thinking. The time is 399 B.C. The place is Athens. Aristarchus is a solid citizen and a patriot and a normal sort of person. He's peevish.

"Only scoundrels" he fumes  
"try to make me think.  
Socrates tries to make me think.  
: : Socrates is a scoundrel!"

He takes a swig of wine. (This is literary license, or something. The wine was oily because the Greeks didn't use corks in the Fourth Century B.C. They floated olive-oil on top of the wine in their amphorae to keep it from turning to vinegar.) He wipes his chin and fumes again. He has arrived at a truth. He has found out what Socrates is—a scoundrel. But what must he do about it? As a patriotic citizen he reasons in the second classic manner:

"Athens must be defended  
against scoundrels.  
Socrates is a scoundrel.  
: : Athens must be defended  
against Socrates!"

If you grant the premises, this is sound thinking. It is logic. So Aristarchus talks around, and public opinion is aroused, and presently a high-level decision is arrived at. And presently Socrates is invited to have a tall drink of hemlock. And then a few days later, Aristarchus is able to think about Xantippe, who is now Socrates' widow. He is in a milder, less indignant mood, and now he can think in a third and modern manner:

"It might be pleasing to comfort a good-looking widow.  
*If* Xantippe is a good-looking widow,  
: : It might be pleasing to comfort Xantippe."

This is the thinking process which appears to be responsible for modern civilization. You will notice two things about it. (1) It is not a novel process of thinking. Our ancestors thought of it first, and knew it as well as we do. (2) It does not arrive at intellectual certitude about what something is, or about what must be done about something. This third and hypothetical manner of thinking establishes possibilities *if*. *If* something is a fact, then . . . such-and-such. This type of thinking links directly with reality. In the illustration, everything is seen to depend upon the objective, "Is, or is not, Xantippe a nice dish?"

(She wasn't.)

Now, people have been thinking and then finding out whether this or that Xantippe was good-looking since the dawn of pre-history. But it used to be dangerous to use this particular intellectual process on other subjects. The habit of restricting its use had to be broken before modernity could set in.

I think of an example. Innumerable years ago it was noticed—you guess how it happened—that if a white-hot steel sword-blade was quenched by sticking it into a living prisoner-of-war, a very superior temper was given to the weapon. This was not a superstition. It was a fact. It could be verified. It would work now. It was something not understood, so the ancients thought about it, to know what the process was. They worked out something like this:

"A soldier's ferocity is part of his life.

When a sword kills him, it takes his life.

:: When a sword kills a soldier it takes his ferocity."

This is reasonable enough. If a man's ferocity is included in his life, what takes his life must take his ferocity. A practical swordsmith would then reflect:

"Good qualities, like temper, are best taken by a sword while it is white-hot."

Which was plain experience. Any swordsmith would know that the temper was put into a sword by getting it white-hot and then quenching it so fast the temper couldn't escape. If you let it cool slowly, the temper got away and you had only annealed metal. So the swordsmith would proceed:

"Good qualities are best taken by a white-hot sword.

Ferocity is a good quality.

:: A white-hot sword takes ferocity best."

And a practical and welcome end to reasoning follows nicely:

"When a sword kills a soldier it takes his ferocity.

A white-hot sword takes ferocity best.

:: When a white-hot sword kills a soldier, it takes his ferocity best."

And this is a perfectly logical explanation of a superior weapon proc-

ess that somebody found out—well—not by accident, but without intending that particular result. An ancient swordsmith would accept it. It met all the demands of classic thought. It arrived at certitude without running any risks of offending anybody. It was safe thinking! It didn't suggest doing anything new. In particular, it answered a question without raising any new questions of what could be done with the answer. If there had been a trace of hypothetical inquiry in that swordsmith's mind, he'd have been tempted to try to make extra-specially good swords by using lions (a slight extra charge if from west of the Gates of Hercules) or angry bulls, or at least an especially ferocious prisoner. But nothing like that happened. Apparently nobody even suspected that an ordinary prisoner might be a lousy soldier, without much ferocity in him.

In any case, if these last ideas had been proposed to a philosopher, he'd have said painedly, "Philosophy deals in the general, not the particular. And why bring that up, anyhow?" Which would be the play-it-safe attitude to take. And he'd take it!

But anybody, in any century A.D. or B.C. could arrive at some interesting stuff if he had the nerve.

"If tempering in cold water gives good temper to a sword,  
And tempering in a prisoner gives a better temper,

:: Tempering in prisoners and water give different tempers."

This doesn't solve anything about the process or what could be done with an answer to what it happened to be. But it isn't an answer to end all questions, either. One could continue:

*"If tempering in water and prisoners gives different results  
And prisoners and water are different substances  
: : Maybe it's tempering in different substances which gives different results."*

Note the "maybe." This is strictly hypothetical. It requires reference to reality before the answer is complete. And this is the great gimmick in the art of thinking which implies the experimental method and may some day move men to the stars.

Our thinker could continue (in any century at all):

*"If tempering in different substances gives different results,  
And oil, salt, water, wine, bitumen, et cetera, are different substances  
: : Maybe tempering in oil, salt, bitumen, et cetera, will give different results."*

And some sort of action on such a fascinating idea would be bound to take place if any man thought of it and had the nerve to putter with it. And something suddenly occurs to me. Of course everybody knows that the "Soooo, boss!" with which cows are soothed at milking-time is—or started out as—purest Attic Greek. But I remember that when

I was a little boy, when commanded to do something promptly and without argument, I was told, "And don't give me any ifs, ands, or maybes!" Which is singularly like the attitude of the ancients. Ifs, ands, and maybes were the headings in syllogisms which played hob with olden times—when they began to be used. This second batch of three syllogisms could have been thought at any period after steel was available. But nobody seems to have thought them. So oil-quenching and salt quenching and the use of wet leather scraps—in place of the prisoner of war—had to wait to be discovered by cottage cutlers in England in the eighteen century or, thereabouts.

The Greeks developed no sciences but mathematics and logic, which couldn't offend anybody. They started plenty! Hydraulics, electricity, steam-power, reaction motors. They made slot-machines and probably optical projectors, but they carried nothing to extremes. Herodotus says, somewhat obliquely, that when Xerxes' troops marched up the mountain passes to take and loot the shrine of the Delphian oracle, the Delphian priests blasted cliffs down on them and they ran away. If he's right, somebody either knew how to make explosives or how to seal up unslacked lime and water in something tight, and how to get away before it blew. But this was an extraordinary measure for an extraordinary emergency. The Greeks

did not use their brains to change everyday life. They simply, starkly, lacked the courage to do it.

The Romans, no less, developed highway construction and water-supply and sewage disposal and the art of government and street-fighting. These were to meet the extraordinary emergencies produced by empire. But thinking on a volunteer basis, so to speak, was firmly frowned upon. There is the story of the artisan who brought a crystal goblet to the Emperor Nero. He dashed it to the ground and it did not break, but was only dented. He picked it up and tapped the dents out with a hammer. He then presented it to the Emperor—who promptly had him beheaded for threatening the prosperity of glass-goblet-makers. And public opinion applauded the act—as some people would like to see everybody able to imagine atomic fission disposed of today.

The discouragement of thinking, and the use of the products of thought only as a final act of desperation—these are inherent tendencies of the non-technically-minded. Primitive cultures abhor thought because thinking changes them from primitive to something else. Such a prospect appalls them. Who wants to risk being appalled? Maybe nobody wants it, but modern men risk it. We can't help ourselves. The ancient classic civilizations were based uncompromisingly on the assumption that man was a smart animal, who could be used as a computer,

a domestic animal (Pliny classified his farm-slaves as "animate agricultural implements") a music box, fish food for the lampreys, electric fans (punkah-wallahs) on warm nights, and as motive power for boats. We think we're more than a smart animal. We think we are creatures with self-respect—which may be conceit—and actual human dignity. And we will risk anything to defend that belief.

This, I think, is the reason for the ending of those charming, intellectual cultures based on degradation, and the struggle toward a modern world based on machinery. I acknowledge that not even the idea needed for a modern world is universally held. The ancients couldn't imagine it, and some of our contemporaries won't admit it. The idea is that of human dignity. No scientific civilization—indeed, no experimental method—could be formed by men who lacked it. The idea of dignity is the possession of power, of riches, of position: of whatever inspires respect and reverence in the beholder. Only kings and very rich men had dignity in olden days. Philosophers didn't!

But there's been an idea around for some time since the Golden Age of Greece. Put bluntly, it is that the newest nakedest human infant in the deepest tropic jungle has a dignity that no other creature may rightfully deny; that the status of being merely a human being implies inalienable rights, which are worthy of respect and reverence. And from



this quaint conviction has come the brashness, the headlong audacity, the blazing intellectual courage to think new things and then try them!

It has been said that the bravest man ever to live was the one who ate the first oyster. To the contrary, the bravest man was the first one who performed actions which—so tradition told him—being new, might be malign magic which would destroy him and all his tribe. There has always been the danger that increased knowledge would mean destruction. You wouldn't deny it of present times, would you?

The danger is real, and it has come about because some of us think what we do about the high dignity of newborn infants. Some of those who can't justify it by reason nevertheless accept it because they like it. And when it is accepted, that curious novelty, that wildly irrational notion of human dignity is dynamite!

So long as I consider myself only an animal I am fairly tractable. I can be enslaved and deplore my misfortune, but know no reason why it should not occur. I can torture or maim or degrade other humans, without any reason for self-restraint. It's their hard luck if I find it useful and can get away with it. This is the way of wild creatures in a state of nature.

But let me think that as a "human being" I have a status which is a valuable possession! Let me think I have rights and privileges: the power of the high justice, the mid-

dle, and the low: reversions, hereditaments, mortmain and such items! Then tell me not to dare exercise those rights: to step down from my high estate: not to dare do as I please . . . I can be pushed just so far, but pardner, there are some things that when you say them—smile!

As a man of dignity, if I feel like taking a chance—whether it is peeking through a microscope or a telescope and acting on the information I gather, or piling together carbon blocks and uranium bricks—anybody who tries to stop me will have his eye spat in and a fight on his hands. I may scare myself to death, but no other man can tell me what I must or mustn't do!

This is not a reasonable attitude. But civilization isn't reasonable! We humans aren't reasonable! We value the freedom to think simply because it requires courage to think. We value freedom because it takes a good man to be really free. We take chances because only when we make our own teeth chatter can we be sure that we aren't fraidy-cats but men—and men of dignity.

The ancients weren't capable of any of this because they hadn't the idea of human dignity. They had no impractical belief that they were more than clever beasts. So they allowed themselves to be guided by common sense, and ruled by practical considerations, and they sanely kept themselves out of trouble. The more intellectual they were, the cagier they were, the safer they kept themselves,

the bigger the stuffed shirts they wore. To us, the most revered of ancient philosophers looks suspiciously like an intellectual Mr. Milquetoast, who never took a chance. That one vanity-inspiring conviction of ours supplies every modern man with at least one chip for each shoulder and lots of extras for emergencies, because that conviction produces courage which fairly itches for exercise. Of course, this leads to eccentricities as well as high achievements. But that, too, is inevitable so long as we hold that we have the right to life, liberty, and the pursuit of happiness; to freedom of speech and assembly. Because it is implicit in the others and may very well summarize them that we claim and maintain an absolute, inalienable right to be crackpots if we feel like it.

I have finished my argument. I admire and respect my forebears of

very long ago. But I do not envy them a bit. They hadn't the one thing I believe has made the world a rather better place than it used to be, and—if kept—will make it better yet. They didn't have a conviction of human dignity, applicable to themselves and to everybody else. They had it tough!

That's my last word. I shan't try to track down the source of the idea of human dignity. I shan't trace its origin or discuss those who disseminated it. Such an enterprise would lead to theology, which is one of those uncomfortable things that suggest that one should do something. I'm a sensible man. I know where to stop. I guide myself by common sense, and I am respectful of practical considerations, and I keep out of trouble.

Like the philosophers of ancient Greece and Rome.

THE END

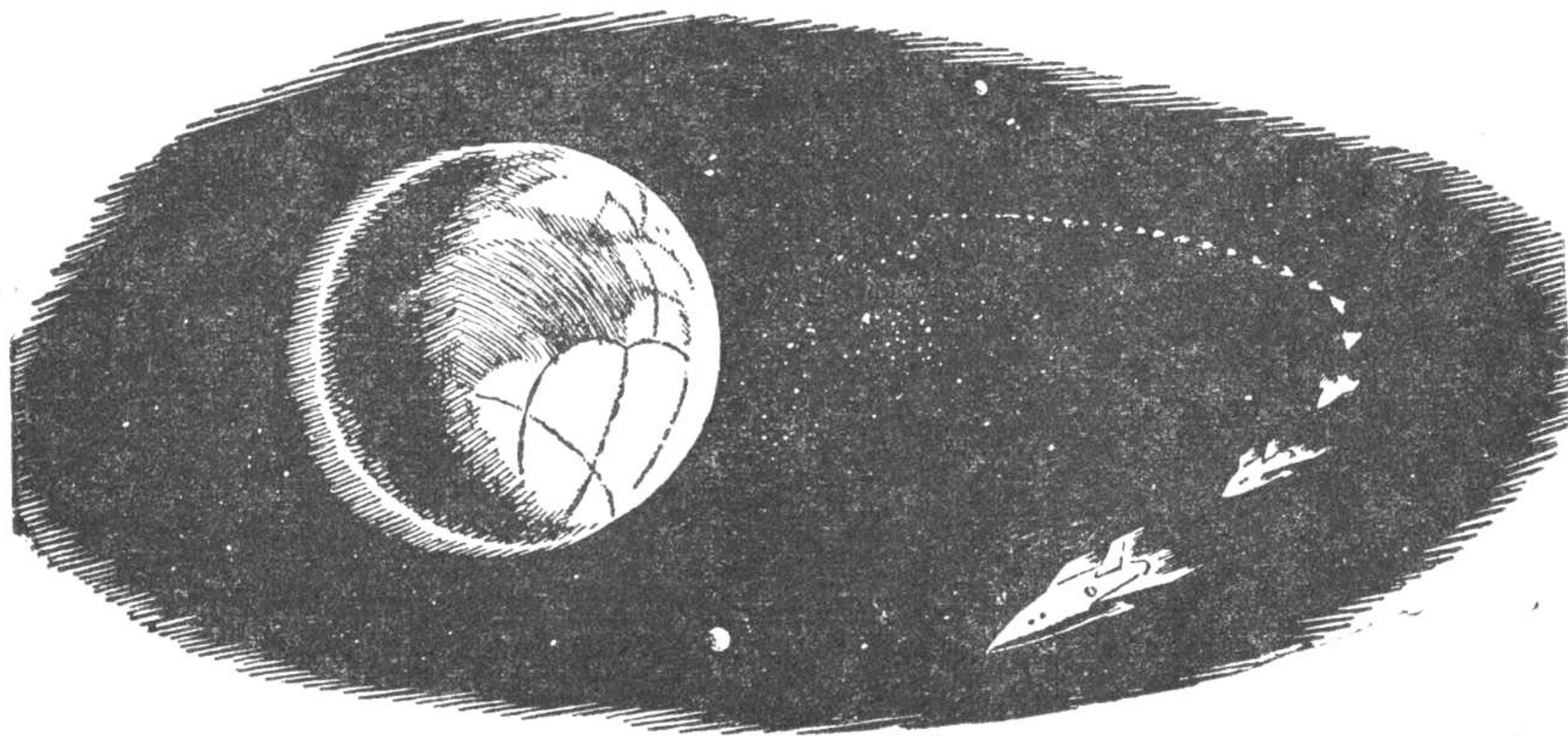



# THE REFERENCE LIBRARY

BY P. SCHUYLER MILLER

## THE SUIT MERCHANTS

When any genre in fiction becomes first acceptable, then temporarily fashionable, in that circle of self-selected folk who admit that they hold in their hands the true direction of Mankind's literary evolution, it is in for a hard time. Mystery fiction was almost killed twice, first by the preciousness of the S. S. Van Dine school, then by the trend to "psychological novels." However, the old bird was tough and the furor attracted the attention of a number of competent, intelligent, vigorous writers who discovered that they

liked the stuff and could have fun writing—and selling—it. I don't think western stories were ever in quite the same fix, but now that western movies have been acclaimed as "*the* uniquely American art form" they are certainly in a tough spot that calls for both the United States Cavalry and a good big posse.

Science fiction seems to be on the same kind of spot now, thanks, perhaps, to the fact that a few nuclear explosions were going off at about the time Ray Bradbury began to grow self-conscious about both the form and significance of his stories. The first result—and all to the good

—was that the newspaper book sections began to review science fiction seriously, and, after a horrible start to let people who knew something about the stuff do the reviewing. Another was that a lot of Writers—the capital is intentional—were told that here is a New Literary Form and tried their hand at it, occasionally with interesting results but more often with ridiculous ones.

A third almost inevitable result is such articles as the long—three and two-thirds page—lead article in the August 27th *Saturday Review*: “The Myth of Science Fiction,” by Siegfried Mandel, an English instructor at Brooklyn Polytechnic Institute who recently served as an oracle on flying saucers for the same magazine, and Peter Fingesten, a sculptor who is said to be an authority on world symbolism. I should be praising the gentlemen, for they have used a generous quotation from the second or third story I ever wrote, at the age of seventeen or eighteen: undoubtedly the July, 1931 issue of *Amazing Stories* will now sell out. But they strike me as people who have no idea at all of what science fiction is all about, and since they are by definition too brilliant to fail to understand it, are here announcing that there’s nothing to understand. It’s a standard myth: the Emperor’s new clothes—and they’re the discerning and brutally honest infant.

It isn’t easy to say exactly what Messrs. Mandel and Fingesten have as their main theme and criticism,

because they bob around a good deal, now swinging a haymaker at a broad generality, now stabbing at just that critical spot between the shoulder blades. But let me follow the reprehensible course of quoting and/or paraphrasing the parts that seem to hang together.

“The heart of the form,” they say, “is a moody discontent with things as they are . . . a magnified claustrophobia.” Whenever man gets into this frame of mind, the argument continues, he resorts to image-making and peoples the universe with creatures of his imagination—with myth-creatures. Modern science fiction, our two critics maintain, is such a mythology—our “quest for a key to the universe.”

“Inside the slick SF package,” we are informed, “is the desire to unlock the door of this world and escape into the beyond—where all is simple machines and clear space. To speed this wish SF has created a mythology which is a counterpart of the cults formed by primitive men . . . who invented mysteries in order to dispel uncertainty. On the heels of mystery entered the elements also present in SF today: symbolism, ideology, codes, priests, salvation, doctrinal terminology, tradition, and prophecy.” They enlarge on some of these later in the article. Science-fiction’s priests are the all-knowing scientists; our vessel of salvation is the spaceship; extraterrestrials are our angels, and other planets are “new Jerusalems”; the control room

of the spaceship is filled with our mechanized icons and sacraments.

There is what amounts to a discussion in the argument in order to complain of the way we treat women—or fail to treat them—in science fiction. Instead of the vessels of sex they should be in “mature” fiction, they are ignored or treated as platonic companions: this is said to be the result of a natural asceticism, bleak sobriety in matters of sex, and desire to evade the reality around us. You take it from there: I’ll admit that Finlay’s nudes are about as stereotyped an art form as present-day burlesque, and that the “Tobacco Road” theme is pretty largely considered immature, while the closest approach to Mickey Spillane is Fritz Leiber’s glorious parody, “The Night He Cried.”

Our betters beam at that fraction of SF which explains or depicts scientific facts or concepts they can understand, “meticulously describing the orbital workings of the universe and the possible flora and fauna of these planets we communicate with.” The SF approach to politics and government, on the other hand, is “absurd.” What this approach is supposed to be is “a world where the scientist not only blueprints and supervises the production of guns and butter and satellite space stations, but also possesses the political power that determines their use” . . . a universe “run by a sort of lofty, technocratic Signory” . . . “monolithic rule by a cabinet of scientific elders,

plus an automatic citizenry” in which “if a person’s character is found incompatible with the ideals of the SF state he is simply regenerated through psycho-physical treatments.” This—God save the mark!—is supposed to be our ideal. And this, I think, we can actively resent as perverted and untrue.

Science fiction has grown up while regimented, totalitarian states were constantly before us for observation, and while our own lives have become more and more restricted in the name of democracy. Logical arguments have been presented by such scientists as Harrison Brown, to indicate that as the population of the planet grows without bounds, against the barrier of limited resources, the alternatives before human society are regimentation or holocaust. But from its beginnings science fiction has seen all this and has surely played with every conceivable variation on the theme except, perhaps, a rule by an elite of world symbolists. And the autocracies of scientists have by and large fared no better than the autocracies of bureaucrats. We don’t like ’em . . . but that doesn’t prevent our talking about them as one of many possible social orders which might come.

Groff Conklin’s introduction to his excellent new Permabook anthology, “Operaiton Future,” makes clear far better than I can what science fiction *is*, as distinct from what Mandel-Fingesten think it is. I won’t quote: go get it and read it—and the book.

One element in this alleged mythology we are creating I think we can accept without dishonor, although it comes in for a good deal of ridicule: "In the new mythology the criterion—for a godlike ultimate—is an abstract: Intelligence."

If there is in all science fiction a real creed or core of conviction, I think it is this one thing—and it is probably the thing which divides pure fantasy from *science* fiction. We believe that the factor which separates Man from the animals is degree of intelligence. We believe that such advances as have been made in human society have, however crudely, been made by the application of intelligence. We believe that whatever advances, mechanical or social, come in the future will be made by using intelligence. We believe that if intelligence is not so used, certain often-expressed trends in our social structure can exterminate us or reduce us to something between life on a Vermont back road and downright savagery.

Turning our backs on the Earth, I should say that we believe that only intelligence will get us into space. Science-fiction writers have said over and over that the only common ground between us and the comparably dominant races of other worlds must be our intelligence. And the only thing that will keep us from trying to wipe each other out—and probably succeeding—is use of that intelligence. This we believe; this our stories teach; and this we can

be proud of making the core of our "mythology."

I can't resist one last pair of quotations, which come a paragraph apart at the end of the article:

"Unfortunately, for most of us the 'machine of the universe' is so complex that it must remain . . . a mystery . . . *unless* one becomes a dedicated disciple of the circle dominated by the scientists and space officers—the new priests! . . . Is not science fiction only one more vain attempt—with new vocabulary and grandiose new symbolism—to loose the fetters of life, rather than understand them?"

They can't understand the scientific view of the universe, they are saying: nobody can but those scientists. So let's reject it. It seems to me that with all their crying out, our two critics are doing no more than complain rather peevishly that science fiction doesn't project and extrapolate their myth-world, whatever that may be like.

And what is it like? They don't say, and I doubt that they know, but in the one place where they do suggest suitable themes for science fiction—as opposed to space, extraterrestrials, ESP—these are "a new suit, union negotiations, or even international politics." Such petty concerns! we are supposed to remark. Well, the little man with his little wife and his little baby and his little dog in their little mech-house, who goes to his little job in a little rocket some time in the little future have had

their vogue in SF—though Mandel and Fingesten seem to have missed them—and with a few exceptions bored us all to death. Why bother with international politics when there are intergalactic problems to play with—not that we haven't explored both? And I'll bet there's a good union story around somewhere—probably by Pohl and Kornbluth.

What, I wonder, would be the reactions of these two suit-buying squares to the four books which—I have just learned—won the top places in the 1955 International Fantasy Awards: 1st, Edgar Pangborn's "A Mirror for Observers" (super-intelligent extraterrestrials supervising us inferior earthlings); 2nd, Hal Clement's "Mission of Gravity" (the fascinating workings of that complex "machine of the universe" that they say are beyond most people); and tied for 3rd, J. T. McIntosh's "One In Three Hundred" (the intensely human problem of having to decide who will ride that "ark of salvation," the spaceship at the end of the world) and Isaac Asimov's "The Caves of Steel" (a grand detective story, but for good measure a commentary on the sourness of a world run by supermen). One novel each from the three top magazines now published, plus one never in a magazine: and nobody need apologize for any of the four.



OPERATION FUTURE, edited by Groff Conklin. Permabooks, New York. 1955. 356 pp. 35¢.

The nineteen stories in this collection add up to one of Groff Conklin's very best anthologies, every bit as good as anything he has brought out between hard covers and better than a few. At the price, nobody can afford to miss it; at ten times the price, you'd be foolish to.

The book opens with a novelette, Theodore Sturgeon's "The Education of Drusilla Strange," which compounds the evidence that Sturgeon is probably the finest writer to come out of the science-fiction field, in theme and handling, and one whose best stories will be remembered as literature as well as science-fiction classics. As an interlude there's another novelette, Chad Oliver's "Blood's a Rover" which appeared here in 1952, more specialized but just as memorable. The other stories offer as good a cross-section of the imaginative freedom of science fiction, as used by the best writers and published by the best magazines, as you'll find anywhere. I won't name favorites, but I'd call John Beynon's "Technical Slip" a fantasy rather than science fiction and Clifford Simak's "Worrywart" is very close to it.

For the record, *Astounding* contributes the following stories in addition to "Blood's A Rover": Eric Frank Russell's "Exposure" (which can't be described without giving away the gimmick), Lester del Rey's "Day Is Done," my favorite among Neanderthal-Cro Magnon tales (though a little Oliver anthropology would have made it still better), Robert F. Young's "The Garden in

the Forest," in which an extraterrestrial Inspector General makes an important basic discovery about galactic discipline. Malcolm Jameson's hilarious "Sorcerer's Apprentice" from way back in 1941, and Lewis Padgett's "Project" with its double switch on the mutant theme.

Incidentally, fifteen of the twenty-two stories in Conklin's 1952 Vanguard Press anthology, "Invaders of Earth," are in a Pocket Book reprint now on the stands at 25¢. It's a Conklin summer, with more to come.



NOT THIS AUGUST, by C. M. Kornbluth. Doubleday & Co., Garden City. 1955. 190 pp. \$2.95.

Not this August, not next August, but in August of 1965, Mr. Kornbluth tells us, North America will be partitioned between victorious Soviet and Chinese armies which have executed the heads of the former United States government and established two People's States after the model which they had found successful in Europe and Asia. And in the rich farming country along the New York-Pennsylvania border (where the author lives) a mixed lot of farmers and country-residents are trying to carry on business as usual.

More reasonably and realistically than in any of the other novels of a Soviet occupation we have had lately, the new regime digs in, step by step, level by level. The native Communists are executed: they are trained

revolutionaries, who may become as dangerous to the new masters as they were to the country they betrayed. The opportunists become petty instruments of the new order. The individualists . . . but that is the story. With one more element: a nearly completed space station hidden under a nearby hill, which must somehow be finished and launched.

There is less physical horror in this than in, say, Tucker's "Long, Loud Silence." But the ease with which the change-over is made is the real horror: there, without grace, go we . . . as the Czechs went, and the Baltic states, and the Poles, the Rumanians, the Bulgars, the East Germans. Not this August, true—but soon.



STAR GUARD, by Andre Norton. Harcourt, Brace & Co., New York, 1955. 247 pp. \$3.00.

Miss Norton, as you should all know by now, ranks second only to Heinlein as a writer of adult-quality science fiction for teen-age readers. If this isn't quite up to her "Star Man's Son," what is?

The time, we are told, is 3956 A.D. (Terran reckoning). Mankind has exploded into an already well organized galactic confederation of humanoid and non-human races, and has accepted the role of mercenaries. Men fight on one of two levels: as Hordes of Archs, serving in personal combat with sword and dagger on



the worlds with primitive societies, and as Legions of Mechs who are trained to the ultimate of mechanized warfare and who may use any weapon the galaxy has at its disposal.

Kana Karr is a greenie—an Arch Swordsman, Third Class, on his first job. It seems unimportant: “police action” for a barbarian princeling on the planet Fronn. But the strong odor of rat is apparent very early in the game, and shortly Kana’s Horde finds itself being hunted through some very rough country by forces which seem to be employing Mechs against Archs in utter defiance of galactic law. There’s plenty of action, a nicely tangled plot, some strange creatures and places, and a last-minute payoff. Not (as I said a moment ago) as good as she’s done before, but much better than many books you’ll be urged to buy.



THE FIFTY-MINUTE HOUR, by Robert Lindner. Rinehart & Co., New York and Toronto. 1955. 293 pp. \$3.50.

You may buy this book as I did, because you’ve heard about the last of the five “true psychoanalytic tales” it contains: “The Jet-Propelled Couch.” I hope that you won’t read that amazing chapter first, because the earlier “tales” do a good deal to build up your understanding of psychoanalytic techniques, and help you to appreciate what was going on in the mind of the young atomic physicist who began to believe that he

was living, at a faster time-rate and at some future time, on the worlds of a famous science-fiction series.

Dr. Lindner is a Baltimore psychoanalyst who writes exceedingly well. These five episodes are “tales” in that he has changed names, places and circumstances to protect the identities of the patients concerned, without altering the nature of their problems, the causes which he finally uncovers for their neuroses or psychoses, and the techniques which he uses. In science fiction, the closest approach that I can recall is Ted Sturgeon’s brilliant “Baby is Three,” but reading Dr. Lindner’s book should help you understand what Sturgeon and others are driving at in some recent stories which deal with the fantasies of the human mind.

The patients we meet are an assorted lot. “Charles,” of the first tale, “Songs My Mother Taught Me,” is a rape-murderer. “Mac,” of “Come Over, Red Rover,” is a convinced and active Communist. “Laura,” of “Solitaire,” has a strange food compulsion. “Anton,” in “Destiny’s Tot,” is a fascistic rabble-rouser who hates the world. Why they have become distorted in these ways is the question of each story; how Dr. Lindner discovers the hidden causes makes the book as fascinating as any locked-room mystery. For the human mind can be sealed more hermetically than any physical room . . .

“The Jet-Propelled Couch” is a fantasy among fantasies. For Kirk Allen, the brilliant, otherwise ordinary physicist has for years identified

himself with the hero of the same name in a famous series of interplanetary fantasies (you can draw your own conclusions as to the identity and real name of the space-hero). He feels that these books are part of his own biography, that what is related there will happen to him somewhere far away in space and not too far in the future. He begins to try to fill in gaps in this story of his own future: to make maps, draft star-charts and genealogies, outline the history of his tributary worlds and their peoples, make serious scientific studies of their flora, fauna, geology and xenology. When the government sends him to Dr. Lindner, this other world has become real and he is withdrawing into it more and more.

On a psychotic level it is what we like to think of as a sane aspect in science fiction: Howard's world of Conan, Lovecraft's pseudo-mythology, Heinlein's future history. The same kind of painstaking work must have gone into "Ice World" or "Mission of Gravity" that went into the twelve thousand pages of typed "biography" and two thousand pages of manuscript notes that Allen turned over to Dr. Lindner. And as we all have, Dr. Lindner found himself being drawn imaginatively into these strange worlds of the future (he was an old s-f fan).

Dr. Lindner is a Freudian: where he seeks out and emphasizes the sexual roots of these psychoses, another analyst of another school might find other sources. But in the all too-fa-

miliar conditions and histories which have brought these five men and women to or beyond the point of breakdown, we can all see the roots of many disturbing features in our society, and of the imagined psychotic societies of science fiction.



SARGASSO OF SPACE, by Andrew North. Gnome Press, New York. 1955. 185 pp. \$2.50.

If "Andrew North" is, as I suspect, Andre Norton, it explains the generally high level of what appears to be the first of a new series of teenage adventure yarns about apprentice Dane Thorson and the Free Trader, *Solar Queen*. The plot may be old and rudimentary, but the detail and suspense are excellently done in good Norton manner.

Assigned as a cargo apprentice to the *Solar Queen*, Dane "Viking" Thorson is soon up to his space-helmet in adventure as his ship bids in the exclusive right to explore a newly charted world, "Limbo." They also pick up a mysterious archeologist and his hard-bitten crew, who are intent on finding relics of the lost super-race, the unknown Forerunners, greatest of those peoples who beat Man into deep space. One mystery piles on another: tracks that end nowhere, tiny gardens in the wilderness, scouts who vanish into thin air, a tremendous mechanism thundering under the mountains, an oily fog, a fantastic roofless labyrinth deep in the bowels of the planet, the rem-

ASTOUNDING SCIENCE FICTION

New Time . . . New Network . . . New Show!

**“STAND BY!  
WITH BOB AND RAY”**

Hatched lovingly in Boston . . .

A ball in New York . . .

And now a riot across the country!

Every day listen to Bob & Ray on your local Mutual station

5:00 to 5:50 PM Local Time

Monday through Friday

MUTUAL BROADCASTING SYSTEM



nants of lost ships with murdered crews . . .

It's excellent space-action-adventure with the ring of conviction that only the best juvenile s-f gives, and only because it is unashamedly an adventure yarn will it be classed a juvenile. Or must space heroes be old men?



**THE CHEMICALS OF LIFE**, by Isaac Asimov. Abelard-Schuman, New York. 1954. 159 pp. \$2.50.

I saw this in the list of Isaac Asimov's books, looked it up, and even though it is a collateral science reader for ages fourteen and up I think you may be interested. For this biochemist (whose tribulations keeping up with his field made a good article a few months ago) is explaining his own specialty in very simple, very graphic terms.

The "chemicals of life" of the title are the enzymes, vitamins and hormones and the nucleic and amino acids which are the basic building blocks out of which most of the more complex molecules are made. You may find it too simple to satisfy you: so complex a field just can't be that easy to understand. But a lot of the puzzles of diet, disease, and the like will begin to make sense.

I've one complaint, especially pertinent in a book for junior high school age. The diagrams by John Bradford are striking and clear, but they don't always key into the text. That's bad editing by someone. It

doesn't really spoil the book, but it will annoy some teachers who might otherwise recommend it enthusiastically.



**SONG OF THE SKY**, by Guy Murchie. Houghton Mifflin Co., Boston. 1954. 438 pp. \$5.00.

Since this is a year old, I won't spend too much time on it, except to say that it's a book most of you should enjoy in whole or in part. It's not a text, though it's packed with information of all kinds—some sound and solid, some, I think, a little dubious. But it does give a unique picture of the inter-relation and interdependence of the sciences involved in present-day navigation.

The author, a navigator headed across the Atlantic to Europe through heavy weather, reflects at length on the history of navigation, meteorology, man vs. nature, and a great variety of kindred topics. The chapters on the winds and clouds are classics, and there are many other memorable sections. It's no "Sea Around Us," though I think it tries to be, and Mr. Murchie is not quite the writer or poet that Exupery was in "Wind, Sand and Stars," but it's a book to read—not one to study. And for good measure the author has studded it with drawings of his own. Sorry I didn't read it long ago, though one year or ten won't spoil a book like this. It should, by the way, make an excellent Christmas

**ASTOUNDING SCIENCE FICTION**

# ADVENTURE OUT OF THIS WORLD . .

*Waits for you in the coming issues of*

## ASTOUNDING SCIENCE FICTION

If you are tired of the usual . . .  
and you thrill to the *unusual* . . .

If you are bored by *trivia* . . .  
and are stimulated by *imponderables* . . .

then you will get your most exciting reading between the covers of ASTOUNDING SCIENCE FICTION Magazine. Each issue of this unusual and interesting magazine brings you full-length serials; intriguing articles; complete novelettes; special features and choice short stories by outstanding science fiction authors.

Every issue is thrill packed for your enjoyment . . . so don't miss a single one! Enter a 12-month subscription NOW and have your copies delivered to your home or office. You will save money by subscribing . . . 12 issues bought on the newsstands cost \$4.20 while a one-year subscription costs ONLY \$3.50.

What's more . . . you can now enter Christmas gift subscriptions for friends at this same low rate . . . an easy way to do your Christmas shopping and make a lot of friends happy all year long!

----- Fill out and Mail Order Form Below -----

### ASTOUNDING SCIENCE FICTION

304 East 45 Street, New York 17, N. Y.

Enter my subscription to ASTOUNDING SCIENCE FICTION . . .  
12 issues for \$3.50

NAME \_\_\_\_\_

ADDRESS \_\_\_\_\_

CITY \_\_\_\_\_ ZONE \_\_\_\_\_ STATE \_\_\_\_\_

Enter a Gift Subscription for:

NAME \_\_\_\_\_

ADDRESS \_\_\_\_\_

CITY \_\_\_\_\_ ZONE \_\_\_\_\_ STATE \_\_\_\_\_

I enclose  Check  Money Order  Cash.

ASF-1-56

present for any man with an interest in science, and for many boys.



**THE SCIENCE BOOK OF SPACE TRAVEL**, by Harold Leland Goodwin. Franklin Watts, Inc., New York. 1954. 213 pp. Ill. \$2.95.

**THE PRENTICE-HALL BOOK ABOUT SPACE TRAVEL**, by William Temple. Prentice-Hall, Inc., New York. 1955. 142 pp. Ill. \$2.75.

With an unmanned space station promised for next year and a Russian boast that they'll have a manned station up first, these two little books may gain a second wind, and have a slight start over the host of new "space travel" books which are bound to be coming.

We'll dispose of the second first. It's an out-and-out juvenile primer, seemingly written for British young people by our old friend and science-fiction master, William Temple. Some upper elementary grade children should be able to understand it, it's sound and scientific enough for junior high, but high school is likely to consider it "written down." The textual matter, however, is sound and up-to-date.

Goodwin, according to the jacket, is the man responsible for planning Civil Defense tests at the AEC's Nevada atomic tests. His book, which has a fine jacket and less attractive text illustrations by Jack Coggins, seems to be intended for teen-agers and can well go on adult shelves in any library. It's a conservative ap-

proach which emphasizes the sound scientific reasons for deflating some of the more enthusiastic pronouncements about when and how we will get into space—yet the author seems to believe in an "outside" source for flying saucers.

Both books (Temple's has rather arty illustrations by one Henry Billings) cover all the familiar ground: how rockets work, how a space station stays up, problems of life in space, conditions on other planets. But they also have the factor which makes it impossible to say that you've read 'em all when you've read Willy Ley or the *Collier's*-Viking symposia. New work is constantly being reported, new papers are published, new talks are given, new ideas are raised and discussed, and the best of these "late comers" do a good job of using these fresh data. Moreover, the authors have their own personal techniques for pointing up various technical arguments. Temple's point about the need for a concave billiard table on a rotating space-platform is neat: balls would roll "downhill" to the point farthest from the center of rotation of the station, if the table were geometrically plane. It needs to be geodesically plane—if there is such a term.

I'd recommend the Goodwin book for friends and relatives who are just coming around to the idea that "there may be something in this space business after all." It's new, it's attractive, and it's authentic. Give 'em Ley, von Braun and Bonestell once they've taken the first step.

Apropos of the coming space station, by the way, it has been pointed out to me by Arthur Draper, Director of Buhl Planetarium here in Pittsburgh, that Goodwin has misunderstood the point of Moulton's calculations of stable orbits in the Earth-Moon system. Moulton found the three (actually four) positions where a small third body would remain essentially stationary with respect to the Earth and Moon.



## REPRINTS OF THE MONTH

SCIENCE-FICTION THINKING MACHINES, edited by Groff Conklin. Bantam Books, New York. 1955. 183 pp. 25¢.

Twelve of the stories from Conklin's excellent 1954 anthology.

LEST DARKNESS FALL, by L. Sprague de Camp. Galaxy Publishing Co., New York. 1955. 125 pp. 35¢.

De Camp's best novel and one of the best time-travel-past books ever written.

LOST ISLAND, by Graham McInnes. New American Library, New York. 1955. 191 pp. 35¢.

A "Signet Giant" and superior science fiction adventure tale in the "Lost Horizon" or Rider Haggard mood: castaways from Drake's expedition of 1582, still alive on a lost Pacific isle.

THE REFERENCE LIBRARY

## Prepare Now for Leadership in the SECOND INDUSTRIAL REVOLUTION COMPUTERS-AUTOMATION-ROBOTS-ETC. with our COURSES, PUBLICATIONS, KITS

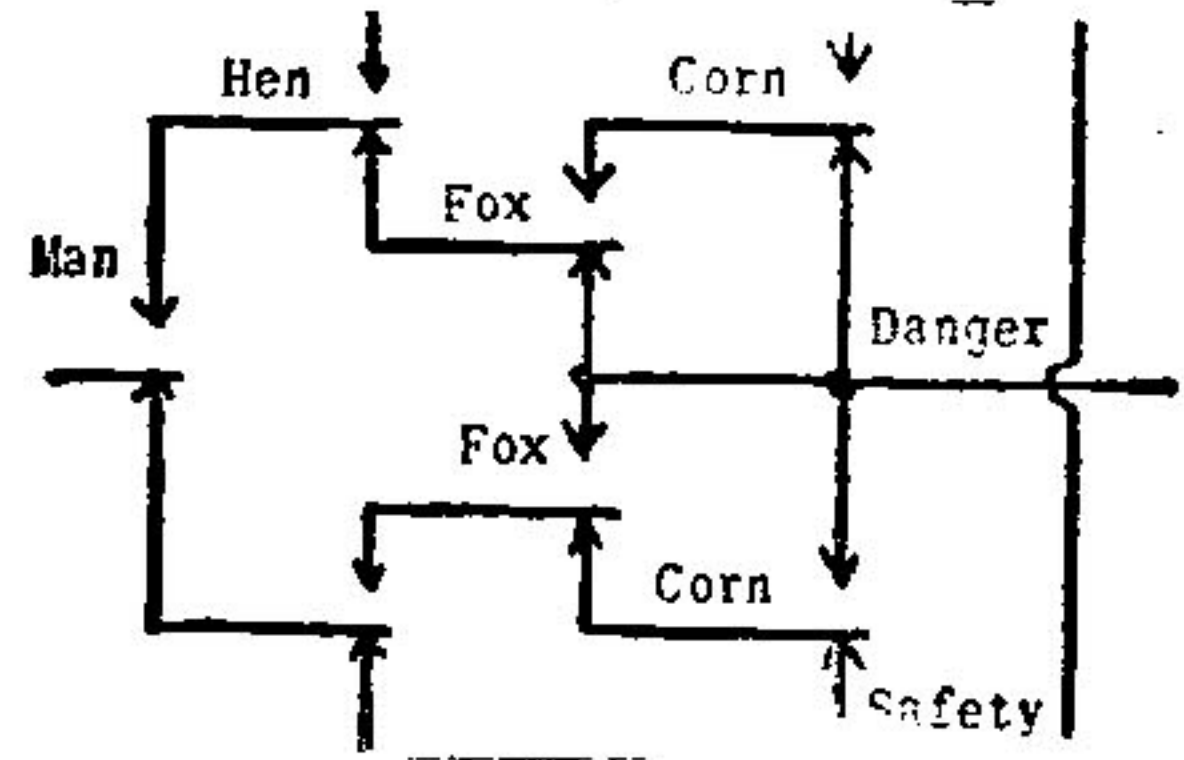

**K1: GENIAC SMALL ELECTRIC BRAIN CONSTRUCTION KIT.** 61-page manual and complete set of over 400 parts for making over 30 arithmetical, logical, reasoning, computing, puzzle-solving and game-playing machines, including NIM, TIT-TAT-TOE, MULTIPLYING MACHINE, FOX HEN CORN AND HIRED MAN PUZZLE, etc. Each Geniac runs on one flashlight battery, requires no soldering, (all connections with nuts and bolts). Demonstrates in instructive and easily put together models the fascinating variety of computing and reasoning circuits. . . . \$17.95, east of Mississippi; \$18.95 elsewhere in U. S.; \$19.95 outside of U. S. **BUY YOUR KIT FROM THE ORIGINATOR.**

**COURSE S 20: THE ALGEBRA OF CLASSES AND OF STATES AND EVENTS, AND HOW TO DESIGN CIRCUITS WITH IT.** The algebra of AND, OR, NOT . . . classes, conditions, on-off circuits, etc. The algebra of WHEN, BEFORE, AFTER, HAPPEN . . . states, events, changes, delay lines, flip flops, sequential circuits, etc. Applications to computing, control, programming, etc. The course includes four publications, totaling 127 pages, course directions, set of questions and assignments, and personal instruction and guidance for eight months. . . . \$18.00

**COURSE C 21: AUTOMATIC COMPUTING MACHINERY.** The Second Industrial Revolution. Automatic machinery for handling information; computers and other data processing machines. Properties, advantages, disadvantages. Applications in business, engineering, government. The course includes a 260-page book, a 160-page directory of manufacturers, products, services, etc., a glossary of over 400 terms, a magazine subscription, course directions, set of questions, assignments, personal instruction and guidance. Course Fee including everything . . . \$28.00

**COURSE M 21: INTRODUCTION TO THE THEORY OF GAMES.** The theory of games of strategy. Pay-offs, saddle points, and other powerful concepts. This course includes a 230-page book, materials for strategic games for analysis (and fun to play), course directions, set of questions and assignments, personal instruction and guidance. Course Fee including everything . . . \$19.00

We are Edmund C. Berkeley and Associates, instructors, publishers (the monthly *Computers and Automation*, publ. P 2, \$4.50, etc.), writers (*Giant Brains*, Wiley, 1949, etc.), consultants, makers and exhibitors of small robots (Simon, miniature mechanical brain—construction plans, P 1, \$5.59; Squee, robot squirrel—construction plans, P 3, \$4.09, etc.). We offer 32 courses, 1 kit, over 25 publications, (including P 10, *The Construction of Living Robots*, \$1.00).

Ask us for information.

**MAIL THIS COUPON**

**EDMUND C. BERKELEY AND ASSOCIATES**  
815 Washington St., R133, Newtonville 60, Mass.

1. Please send me items circled:  
K1 S20 C21 M21 P2 P1 P3 P10

**RETURNABLE** in 7 days for full refund if not satisfactory. I enclose \$\_\_\_\_\_ in full payment (add 10 cents per item for handling and postage).

2. Please send me free announcements.  
My name and address are attached.

(Continued from page 7)

culture is quasi-deifying Marx and Lenin, but showing signs of dropping that approach to the problem.)

People don't like to think they are being experimented on; since they are going to be anyway, willy-nilly, they are more comfortable to *believe* that the culture Knows What's Right. Hence any social scientist finding contrary truths isn't going to be acceptable; he'd better keep his trap shut before it gets shut for him.

Currently, the best social doctrines, applied by the most highly trained experts, appear to yield exceedingly sour results. Raising children is, was, and always will be the most completely experimental technique im-

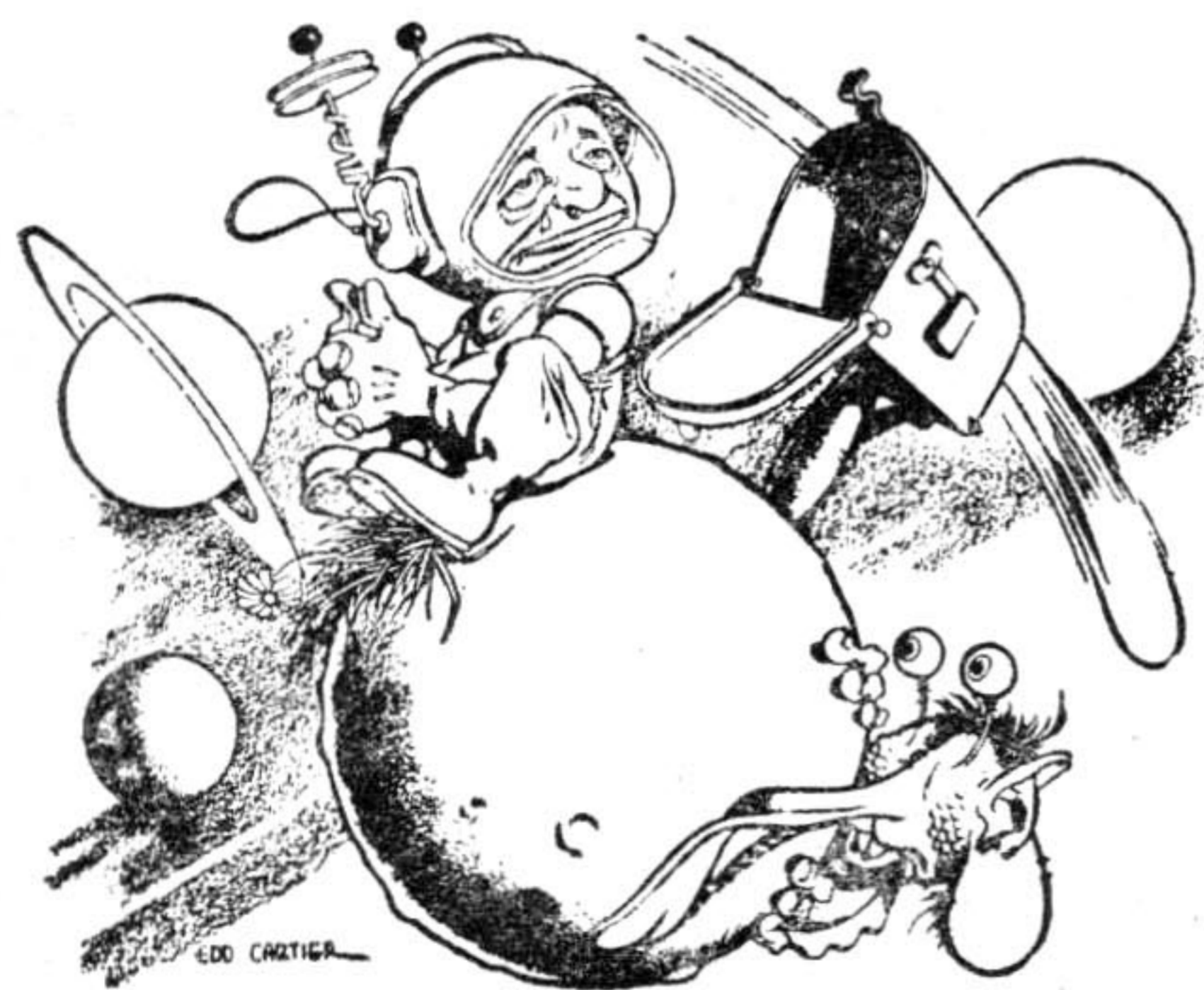

## MOVING?

### Going to have a new address?

We can't send your regular Astounding SCIENCE FICTION along if you don't warn us ahead of time. If you're going to move, let us know six weeks in advance. Otherwise you'll have a neglected mailbox!

**Write SUBSCRIPTION DEPT.**

**Astounding SCIENCE FICTION**

**304 East 45th St., New York 16, N. Y.**

aginable; a parent can only do what he hopes is best. Observations might be made on the correlation between happiness and general human success in living of the children, and the degree of theoretical sociological-psychological training of the parents, for example, as one rough check on the validity of psycho-social theories. If the children of child psychologists show a markedly higher or lower index of neurosis and social conflict, for example, it might be at least indicative. In any home, experiments with living human beings are constantly under way—whether we like to acknowledge it or not.

Another way to check up on the correlation between the cultural rules on How To Be A Perfect Human Being, and the facts of life and living, would be to make a careful and unbiased check on the *actual* personalities of outstandingly successful human beings. You can do that yourself to some extent, and the results may surprise you somewhat.

One thing to look out for; if the *actual* living personality of one of the cultural heroes did *not* fit the cultural concept of How To Be A Perfect Human Being, anyone documenting that discrepancy will be called a "muckraker." Simple example: The old Parson Weems' fable about George Washington and the never-tell-a-lie business. When that fable was first proven to be a fable, there was considerable outrage at the "muckraking." When the life of a cultural hero does not correspond with the cultural thesis, proof of



# Never, Ever Before, Anywhere!!

7000 fantasy and science-fiction books and back-issue mags at 50% to 90% under what they've ever cost you before, here or anywhere, while they last! List free.

## WEREWOLF BOOKSHOP

Shannon Rd., R. D. 2, Box 86A, Verona, Pennsylvania

that discrepancy is *not* considered indication *that the cultural belief* is wrong, but is considered a rather indecent exposé of the *weakness of a great personality!*

George Washington was a liar—and a practiced one. The absolute necessity of lying in the real world was an item I discussed here recently. Parson Weems, in trying to foist off that fable that little George never told a lie was trying to bolster a basic cultural blunder. The facts did *not* support the cultural thesis; therefore Parson Weems had to lie. He recognized the utility of lying all right!

The cultural thesis holds that a man who is self-made, young, in excellent health, wealthy, highly intelligent, something of an athlete, scientist, business man, and an artist, with a young and beautiful wife, having many friends, is automatically and of course a happy man.

Let's take a look at the actuality. Assume a man who has, at the age of thirty-five, succeeded in establishing a reputation as an athlete, has established his own business, based on his own scientific discoveries, and

made four or five million dollars. His hobby interest is, we'll say, music; he plays well, and composes well enough to have some of his compositions played by a major symphony orchestra. He has also published fiction professionally. His success in business is necessarily dependent on understanding of economic principles, and psychology as related to personnel, and salesmanship. These abilities also helped in winning the specified young and beautiful wife.

Now if the man has accomplished all of this by the time he is thirty-five, I can guarantee that he has no warm, close friends. His wife won't be very close to him, either, probably. Reason: to achieve all these things, he has had to develop unusual competence in four or five fields of human activity in a time less than normal, competent men need to develop competence in *one*. The only way that could be done would require that the individual be able to think, learn, and decide at least five times as rapidly as a normally competent man.

But this means that he is abnor-

mal. He will make normally competent people who come in close contact with him "feel stupid," because he can solve their problems four or five times as fast as they can, with the result that he invariably solves their presented problem before they've finished getting well started on thinking about it.

The cultural thesis *says* such a man will be vastly respected and admired. He won't be; he'll be disliked, but grudgingly respected, as one respects a dangerous enemy.

When a man asks, "Well . . . what would you have done in a spot like that?" you can earn his undying enmity by giving him an immediate, concise, and accurate answer. The man who *can* fulfill the cultural theses on How To Be A Perfect Human Being *can* answer the posed question. If he *does*, he'll make the fortune predicted—and have only sycophants for friends.

The way to have friends, as observed in fact, not in the socio-cultural thesis, is to prove you are very smart and very competent in some thoroughly inhuman area. Like cosmology or vulcanology, say. And then failing to "be able" to answer the human problems of daily living. This makes you a popular person; it helps other people feel wise and competent and not-stupid, because they can be assured that even a very smart man can't answer the problems they can't. Everybody liked Einstein because he couldn't make out his income tax either.

The inevitable consequence of that

is that people studying the social sciences are up against the violent resentment of all normal human beings—if they solve the problems normal human beings have tried to solve and couldn't. A man doesn't mind if you solve a problem concerning the structural formula of hemoglobin; it's a problem he never wanted to solve anyway, and never tried to solve.

But every man has tried to solve the problems of interpersonal relations. Offer a neat, concise, and workable solution in that area—and you make every human being feel stupid and/or guilty. He should have thought of that himself, if he had half a brain! And it wasn't that he wasn't trying, because he was. Therefore he is faced with the fact that he *does* have only half a brain.

How unpopular can a man get? Be a social scientist who actually works out successful solutions and find out!

That factor, not lack of opportunity to experiment, is what prevents the development of social sciences. The social scientist is in somewhat the position of the man who, captured by the cannibal tribe, is told that if he fails to answer the posed question correctly, he will be killed, and that if he insults the King he will be killed. The question is, "What man is wiser and more powerful than the King?"

It's possible there might be some neat logical dodge around this—but neat logical dodges don't work on real cannibals.

THE EDITOR.

—Continued from Back Cover



**\$1.00 IS ALL YOU PAY FOR ANY 3 OF THESE GREAT BOOKS**  
*when you join the Club*

**Each One Packed from Cover to Cover With Thrilling, Top-Flight Stories of Science-Fiction**

**THE TREASURY OF SCIENCE-FICTION CLASSICS**

World-renowned stories that have stood the test of time — by H. G. Wells, Jules Verne, Sir Arthur Conan Doyle, Aldous Huxley, Philip Wylie, Edgar Allan Poe, E. M. Forster, F. Scott Fitzgerald, etc. 704 pages. (Publ. ed. \$2.95)

**OMNIBUS OF SCIENCE FICTION**

43 top-stories by outstanding authors . . . stories of Wonders of Earth and Man . . . of startling inventions . . . of visitors from Outer Space . . . of Far Traveling . . . Adventures in Dimension . . . Worlds of Tomorrow. 562 pages. (Publ. ed. \$3.50)

**THE ASTOUNDING SCIENCE-FICTION ANTHOLOGY**

A story about the first A-Bomb . . . written before it was invented! A story of the movie machine that shows "newsreels" of any past event. Plus a score of other best tales from a dozen years of Astounding Science-Fiction magazine by its editor, John W. Campbell, Jr. (Publ. ed. \$3.95)

**THE BEST FROM FANTASY AND SCIENCE-FICTION**

Selected stories from *Fantasy and Science-Fiction Magazine*. The woman who became her own daughter . . . atomic power from beans . . . the man that lived 300 years . . . gambling on a strange planet . . . and many others. (Publ. ed. \$3.25)

**CHILDREN OF WONDER**

21 remarkable and fantastic tales about some of the most awe-inspiring, charming and monstrous children imaginable, by outstanding authors like Bradbury, Graham Greene, D. H. Lawrence, and others. (Publ. ed. \$3.00)

**ASSIGNMENT IN TOMORROW**

A complete short novel, 3 novel-ettes and 12 short stories combine to make a truly scalp-tingling volume about the cosmic life of the future — edited by Frederik Pohl. Absorbing stories that provide a chilling glimpse into tomorrow. (Publ. ed. \$3.50)

**PORTALS OF TOMORROW**

A sparkling crop of weird and wonderful tales selected by expert August Derleth. The man who invented a solid vacuum . . . the Martian ship which lands on Earth on Hallowe'en, and many others. (Publ. ed. \$3.75)

**Now—THE BEST NEW SCIENCE-FICTION BOOKS FOR ONLY \$1.00 EACH!**

**IMAGINE** — ANY 3 of these full-size, brand-new science-fiction anthologies — yours for just \$1! Each is crammed with the science thrills of the future . . . written by the most sought-after science-fiction authors of today. A \$9.20 to \$11.20 value, complete and in handsome permanent bindings.

Each month the **SCIENCE-FICTION BOOK CLUB** brings you only the finest brand-new full-length books **FOR ONLY \$1 EACH** (plus a few cents shipping charge) — even though they cost \$2.50, \$3.00 and up in publishers' editions! Each month's selection is described **IN ADVANCE**. You take **ONLY** those books you really want — as few as four a year.

**SEND NO MONEY**

*Mail Coupon TODAY!*

We **KNOW** you will enjoy membership in this new book club. To **PROVE** it, we are making this amazing offer! Your choice of ANY 3 of the new Science-Fiction anthologies — at **ONLY \$1 FOR ALL THREE**. Two are your gift books for joining; the other is your first selection. This liberal offer may have to be withdrawn at any time. So mail coupon **RIGHT NOW** to:  
**SCIENCE-FICTION BOOK CLUB**  
**Dept. ASF-1 Garden City, New York**

**WHICH 3 DO YOU WANT FOR ONLY \$1.00?**

**SCIENCE-FICTION BOOK CLUB, Dept. ASF-1, Garden City, New York**

Please rush me the 3 anthologies checked below, as my gift books and first selection. Bill me only \$1 for all three (plus few cents shipping charges), and enroll me as a member of the Science-Fiction Book Club. Every month send me the Club's free bulletin, "Things to Come," so that I may decide whether or not I wish to receive the coming selection described therein. For each book I accept, I will pay only \$1 plus shipping. I do not have to take a book every month (only four during each year I am a member) — and I may resign at any time after accepting four selections.

**SPECIAL NO RISK GUARANTEE:** If not delighted, I may return all books in 7 days, pay nothing and this membership will be cancelled!

- |  |   |
|--|---|
| <input type="checkbox"/> Assignment in Tomorrow                | <input type="checkbox"/> Children of Wonder                   |
| <input type="checkbox"/> Astounding Science-Fiction Anthology  | <input type="checkbox"/> Omnibus of Science-Fiction           |
| <input type="checkbox"/> Best from Fantasy and Science-Fiction | <input type="checkbox"/> Portals of Tomorrow                  |
|  | <input type="checkbox"/> Treasury of Science-Fiction Classics |

Name .....

(PLEASE PRINT)

Address .....

City ..... Zone ..... State .....

Selection price in Canada \$1.10 plus shipping. Address Science-Fiction Club, 105 Bond St., Toronto 2. (Offer good only in U. S. and Canada.)

The Most Generous Offer Ever Made By

# The SCIENCE-FICTION BOOK CLUB

TAKE  
**any 3**  
OF THESE  
THRILLING ANTHOLOGIES OF  
**SCIENCE-FICTION**

Yours for  
Only **\$1.00**  
WITH  
MEMBERSHIP

SEE OTHER SIDE  
FOR COMPLETE DETAILS

A \$9.20 to \$11.20 value—  
you pay just \$1.00 for any 3!

HERE'S an offer that is as thrilling as the incredible, spine-tingling stories crammed between the covers of these anthologies! These volumes contain not only "top-drawer" science-fiction, but also science facts by outstanding authorities. Handsome, permanent bindings. Any 3 of them would normally cost you \$9.20 to \$11.20 in publishers' original editions—but all you pay is just

\$1.00 when you join the Club!

This generous offer is made to introduce you to the SCIENCE-FICTION BOOK CLUB, a wonderfully new idea in bringing you the best of the new science-fiction books—at a mere fraction of their usual cost! Take advantage of this offer now—pick your 3 anthologies and mail coupon on other side of this page TODAY!